

OUTLINE FOR QUASI-JUDICIAL PUBLIC HEARING
Newberg Planning Commission

- 1. CALL TO ORDER**
OPEN THE PUBLIC HEARING, ANNOUNCE THE PURPOSE, DISCUSS TESTIMONY PROCEDURE, AND TIME ALLOTMENTS
- 2. CALL FOR ABSTENTIONS, BIAS, EX PARTE CONTACT, AND OBJECTIONS TO JURISDICTION**
- 3. LEGAL ANNOUNCEMENT**
READ “QUASI-JUDICIAL ANNOUNCEMENTS” SHEET
- 4. STAFF REPORT**
COMMISSION MAY ASK BRIEF QUESTIONS FOR CLARIFICATION
- 5. PUBLIC TESTIMONY**
5 MINUTE TIME LIMIT PER SPEAKER (15 MINUTE LIMIT FOR APPLICANT AND PRINCIPAL OPPONENT). SPEAKER GOES TO WITNESS TABLE, STATES NAME & PRESENTS TESTIMONY. COMMISSION MAY ASK QUESTIONS OF SPEAKERS.
 - A. APPLICANT(S)
 - B. OTHER PROPONENTS
 - C. OPPONENTS AND UNDECIDED
 - D. STAFF READS WRITTEN CORRESPONDENCE (TIME LIMIT APPLIES)
 - E. APPLICANT REBUTTAL
- 6. CLOSE OF PUBLIC TESTIMONY PORTION OF HEARING**
- 7. FINAL COMMENTS FROM STAFF AND RECOMMENDATION**
- 8. PLANNING COMMISSION DELIBERATION INCLUDING DISCUSSION OF CRITERIA WITH FINDINGS OF FACT**
- 9. ACTION BY THE PLANNING COMMISSION**
 - A. ORDER OR RESOLUTION – Usually requires passage of order if the commission is the final decision maker, or a resolution if the commission is only advisory to the council.
 - B. VOTE – Vote is done by roll call.
 - C. COMBINATION – Can be combined with other commission action; separate vote on each action is required.

**QUASI-JUDICIAL
PUBLIC HEARING PROCESS
TESTIMONY AND EVIDENCE REQUIREMENTS**

ORS 197.763 requires certain statements to be made at the commencement of a public hearing.

- The applicable City and State zoning criteria must be listed. This means that we must advise you of the standards that must be satisfied by the applicant prior to our approval of an application. The Planning Staff will list the applicable criteria during his or her presentation of the staff report.
- Persons wishing to participate in this hearing must direct their testimony or the evidence toward the criteria stated by the Planner or other specific City or State criteria which you believe apply. You must tell us why the testimony or evidence relates to the criteria.
- Any issue which might be raised in an appeal of this case to the Land Use Board of Appeals (LUBA) must be raised in person or by letter at the local level prior to the City approving or denying the application. The law states that the issue must be raised in enough detail to afford the decision-maker and the parties an opportunity to respond. This part of the law is also known as the "raise it or waive it" requirement. If you do not bring it up now, you can't bring it up at LUBA.
- Failure of the applicant to raise constitutional or other issues relating to proposed conditions of approval in enough detail to allow the local government or its designee to respond to the issue precludes an action for damages in Circuit Court.
- Prior to the conclusion of the initial evidentiary hearing on an application, any participant may request an opportunity to present additional evidence or testimony regarding the application. The Planning Commission will grant such a request through a continuance or extension of the record.

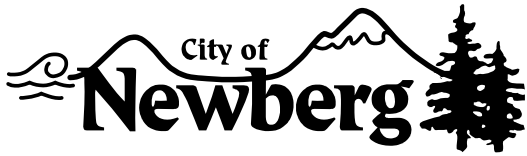

Community Development Department

P.O. Box 970 ▪ 414 E First Street ▪ Newberg, Oregon 97132
503-537-1240 ▪ Fax 503-537-1272 ▪ www.newbergoregon.gov

STAFF REPORT

Type III Comprehensive Plan Map Amendment & Zoning Map Amendment

CPA-15-001/ZMA3-15-001: Martell Commons

FILE NUMBER:	CPA-15-001/ZMA3-15-001
REQUEST:	Amend the Comprehensive Plan Map designation of the property at 1317 Villa Road from LDR (Low Density Residential) to HDR (High Density Residential) and amend the Zoning designation from R-1 (Low Density Residential) to R-3 (High Density Residential)
APPLICANT:	DJ2 Holdings, LLC (represented by AKS Engineering & Forestry, LLC)
OWNER:	Martell Family Farms, LLC
LOCATION:	1317 Villa Road, Yamhill County tax lot 3217BC-800
DESIGNATION:	Comprehensive Plan designation of LDR (Low Density Residential); Zoning designation of R-1 (Low Density Residential), with a small Stream Corridor overlay section
CODE CRITERIA:	Newberg Development Code § 15.302.030(A)(3), applicable Comprehensive Plan goals & policies
HEARING DATE:	Planning Commission Hearing on May 14, 2015

ATTACHMENTS:

1. Planning Commission Resolution 2015-307 with:
 - Exhibit A: Findings
 - Exhibit B: Location Map
 - Exhibit C: Legal Description
 - Exhibit D: Comprehensive Plan Map
 - Exhibit E: Zoning Map
2. Public & Agency Comments
3. Aerial Photo
4. Application
5. Newberg Development Code & Comprehensive Plan
(by reference)

Location Map

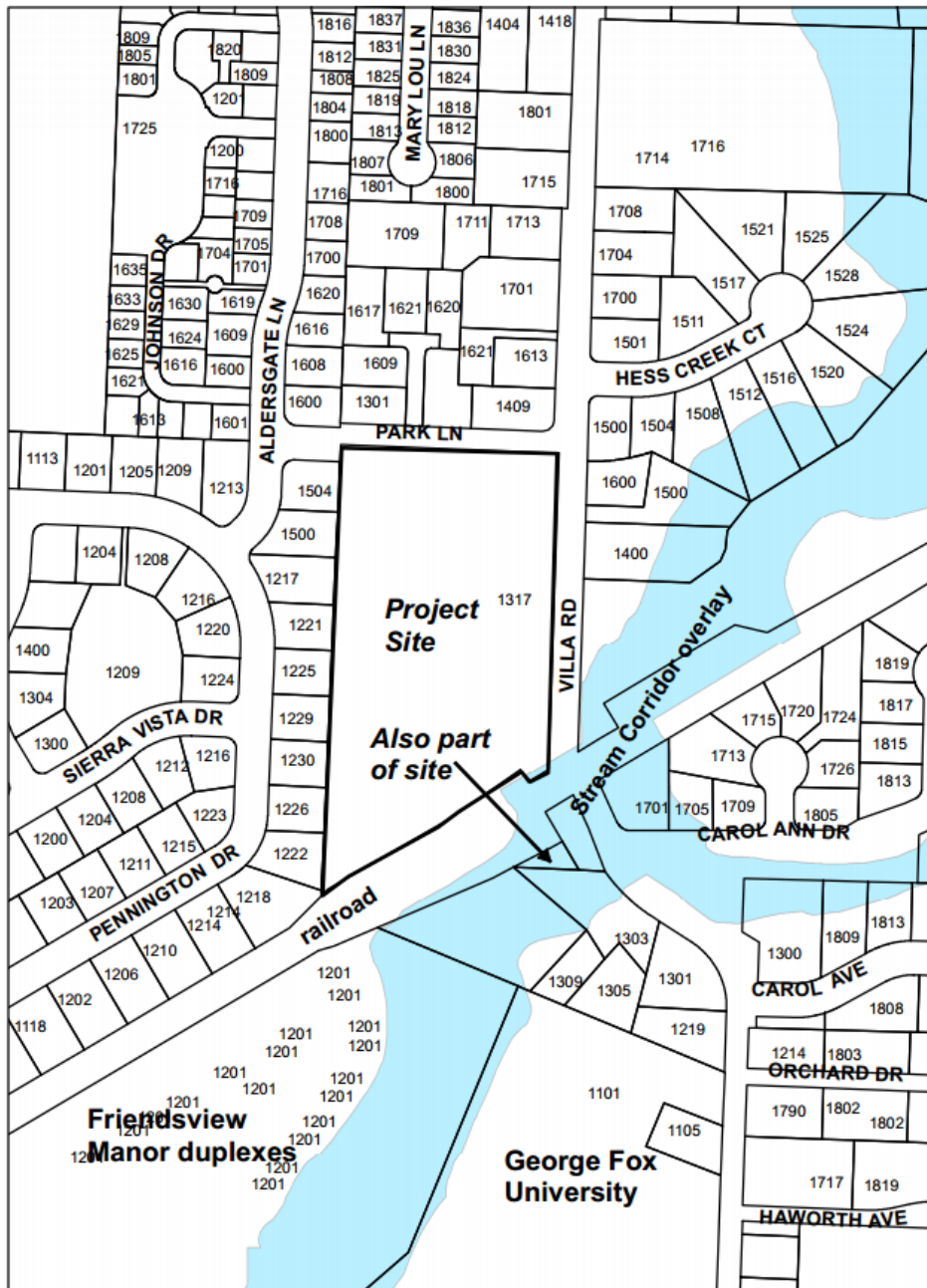

Proposal

Amend the Comprehensive Plan Map designation of the property at 1317 Villa Road from LDR (Low Density Residential) to HDR (High Density Residential) and amend the Zoning designation from R-1 (Low Density Residential) to R-3 (High Density Residential). If this application is approved then the applicant will apply for design review approval of a multifamily apartment project, to be named Martell Commons.

Process

This is a Type III application for a Comprehensive Plan map amendment and a Zoning map amendment. A Type III application of this nature goes first to the Planning Commission for a recommendation and then to the City Council for a final decision. The Planning Commission will hear this proposal on Thursday, May 14th at 7 p.m. at the Newberg Public Safety Building (401 E Third Street). A City Council hearing is tentatively scheduled for Monday, July 6th to review the application and the recommendation of the Planning Commission.

The applicant held a neighborhood meeting in December 2014 to discuss the proposal and the concept plan. This was not required by the city, but enabled the applicant to learn about neighborhood concerns about traffic impacts, the number of units proposed, and adequate parking. Based on the feedback, the applicant revised the concept plan to reduce the number of units, increase the amount of parking provided per dwelling unit, and reduce the number of buildings along the western property line.

It is important to note that the concept plan is not being approved at this time, and the applicant is not bound by the concept plan in this Comprehensive Plan map amendment/Zoning map amendment application. If this Comprehensive Plan map amendment/Zoning map amendment application is approved then the applicant will apply for design review approval. A design review application would include more detailed information about the design of the buildings, parking layout, preliminary grading and utility plans, landscaping and outdoor recreation area plans, and street frontage improvements. A design review application is a Type II process: there is public notice mailed to all property owners within 500 feet, the site will be posted with signs, and there is a two-week period to submit public comment. The Community Development Director then makes a decision on the application. Anyone who submits a comment is sent notice of the decision, and there is a two-week appeal period. If the decision is appealed then it goes to the Planning Commission for a public hearing and review.

Noticing: Important dates related to this application for a comprehensive plan amendment/zoning map amendment are as follows:

1. 4/27/15: The Community Development Director deemed the application complete.
2. 4/22/15: The applicant mailed notice to the property owners within 500 feet of the site.
3. 4/26/15: The applicant posted notice on the site.
4. 4/29/15: The Newberg Graphic published notice of the Planning Commission hearing.
5. 5/14/15: The Planning Commission will hold a quasi-judicial hearing to consider the application.

Criteria: The following criteria apply to the subject proposal:

15.302.030 Procedures for comprehensive plan map and zoning map amendments.

3. Amendment Criteria. The owner must demonstrate compliance with the following criteria:

- a. The proposed change is consistent with and promotes the goals and policies of the Newberg comprehensive plan and this code;**
- b. Public facilities and services are or can be reasonably made available to support the uses allowed by the proposed change;**
- c. Compliance with the State Transportation Planning Rule (OAR 660-012-0060) for proposals that significantly affect transportation facilities.**

Site Information

The site is approximately 5.94 acres on tax lot 3217BC-800. The property is bifurcated by the railroad right of way; the main parcel is 5.91 acres, and the small remnant parcel is 0.03 acres. The remnant parcel is south of the railroad tracks and entirely within the City stream corridor overlay, so no development is proposed for the remnant parcel. The main parcel contains a single family house, and has remained in farm use as the area around it urbanized.

Surrounding uses:

- North across Park Lane: Developed with predominantly single family detached homes with primarily R-2 zoning, with some R-1 zoning along Villa Road.
- East across Villa Road: Developed with single family detached homes to the northeast. Most of the property east of the site adjacent to Villa Road is zoned either Institutional or R-1, but is undeveloped because it is in the stream corridor.
- West: The site abuts existing single family detached homes in an R-1 zone.
- South across the railroad corridor and the stream corridor: There are single family detached homes in an R-1 zone and George Fox University facilities to the southeast. To the southwest are duplexes that are part of the Friendsview Manor development.

Existing conditions: Villa Road runs along the eastern boundary of the site and is an unimproved City road, classified as a major collector with a 50-foot right-of-way. Park Lane runs along the northern boundary, and is an unimproved City road, classified as a residential road with a 30-foot right-of-way. There are two large trees close to Villa Road; unfortunately, any street improvements along Villa Road will probably require the removal of these trees. There is an 8-inch public water line that runs down Villa Road and Park Lane that could serve the proposed site if it is determined to be sized large enough for the development. As part of final development, a fire flow analysis will be performed to determine if any existing water lines would need to be upsized. There is a 12" sewer line located to the south and east of the property which could serve the property. The downstream system is currently at capacity, however the City's Sewer Master Plan identifies pipe upsizing necessary for any further development on the system. The zone change from R-1 to R-3 increases the sewer demand on the system by 1.8%, which does not change the required pipe size. Further investigation will be performed by the developer at the time of development to determine if there is sufficient capacity for any further development, regardless of a zone change, including flow testing. There is a 24" storm sewer line at the southern boundary of the property, as well as the adjacent Hess Creek, which could serve the property. Stormwater quality and quantity facilities would be required with development which would limit the stormwater impacts of the property. The topography of the site is sloping from north to south.

Agency Comments:

The application was routed to several public agencies for review and comment. Comments and recommendations from city departments have been incorporated into the findings and conditions. The findings are jointly written by the Planning and Engineering divisions. As of the writing of this report, the city received the following agency comments:

- Oregon Dept. of Transportation:
Gerry Juster and I have reviewed this application and have determined that ODOT will not have any comments. This is due to the limited impact we expect the project will have on state facilities. Thank you for referring this application to ODOT for review. Please feel free to contact me or Gerry if you have questions or need additional information.

Dan Fricke, Senior Transportation Planner
Oregon Department of Transportation
Region 2

455 Airport Road SE Building B

Salem, OR 97301-5395

Ph: 503-986-2663 Fax: 503-986-2840

e-mail: daniel.l.fricke@odot.state.or.us

- Oregon Dept. of State Lands: A state permit will not be required for the proposed project because based on the submitted site plan the project appears to avoid impacts to jurisdictional wetlands and waters. This is a preliminary jurisdictional determination and is advisory only.
- PGE: Reviewed, no conflict
- Waste Management: Reviewed, no conflict. Will need input at the building permit stage for trash and recycling.
- Fire Dept: Reviewed, no conflict
- Police Dept.: This is a summary – the full comment is included in Attachment 2. The Department has concerns about pedestrian/vehicle mixed use safety, parking, and the number of driveways within such close proximity of one another. Park Lane must be widened to a full street width. The on-site parking for the apartments seems adequate, but inevitably there will be some on-street parking; consider removing on-street parking along the north side of the street to minimize congestion. It is very important that pedestrian and bike improvements are completed along Villa Road for safety. The driveway on Villa Road is very close to Park Lane, and may create a safety issue.

Public Comment:

As of the writing of this staff report, the city has received no written public comments.

Issues & Analysis summary:

1. **Police Dept. comments:** The department raised many valid concerns about street improvements, pedestrian safety, parking, and driveway locations. The decision on these design issues will actually be made during the design review application phase. The applicant is now aware of the Police Department concerns. If the Comprehensive Plan map amendment/Zoning map amendment is approved then the applicant will need to address these issues in their design review application. The concept plan for the site is not being approved as part of this application, and no decisions are being made on driveway location, parking, or the design of the street improvements that will be required.
2. **Do the relevant Comprehensive Plan policies support the change:**
The Comprehensive Plan includes policies regarding high density housing location, dispersal of high density housing, design of high density housing, and compatibility with surrounding development.

These policies are addressed in more detail in the findings. The proposed site is adjacent to a major collector road which will provide adequate access for higher density housing. Changing the site to HDR would comply with the city goal of dispersing high density housing throughout the city instead of concentrating it in any one area. In addition, any R-3 development will have to meet the additional design review criteria for multi-unit housing. Overall, the proposed Comprehensive Plan map amendment/Zoning map amendment promote the efficient use of land within the urban growth boundary, improves housing diversity in this part of the city, provides multifamily housing close to urban services and employment, and is located along a major collector; the amendment is supported by Comprehensive Plan policies.

3. **Does the city need more HDR land and multifamily housing:** The applicant has prepared a Housing Needs Analysis, which shows that Newberg does not have enough land in the urban growth boundary in any of the housing categories (low density, medium density or high density) to accommodate growth over the next 15 years. The greatest shortfall, however, is in the HDR category. Newberg has the current capacity to accommodate 91% of the projected LDR need, 51% of the projected MDR need, but only 11% of the projected HDR need. Changing LDR land to HDR would help address the shortfall, as the city currently has a greater need for HDR land than LDR land.
4. **Is this site suitable for HDR land:** The main issues to address are the traffic impacts, and whether there are adequate public facilities to support the potential development
 - **Transportation improvements:** The proposed development site is located adjacent to Villa Road and Park Lane and would take direct access from both streets. Park Lane is currently developed below City residential street standards. The future development would construct a 1/2 street improvement on the south side of Park Lane to residential standards, and dedicate additional right of way. Villa Road is currently constructed below City major collector standards. The future development would construct a 1/2 street improvement on the west side of Villa Road to major collector standards, and dedicate additional right of way. The street frontage improvements and right of way dedication would take place after design review approval for the apartment project.
 - **City transportation project:** The City is currently beginning design of transportation improvements to Villa Road from Haworth Avenue to Crestview Drive. This project is on the city Capital Improvement Project list, and funded by transportation system development charges (SDCs) the city levies on new development. During the development application review for this apartment project, coordination of street improvements with the City-led project will be necessary, and will be completed at that time.
 - **Traffic impact:** The application includes a traffic study that analyzes the impact the proposal would have on trip generation & distribution, safety, and operational functions through the year 2035 for several surrounding intersections. According to the applicant's traffic impact study, all

intersections studied currently operate at acceptable levels of service during the weekday a.m. and p.m. peak hours.

2016 Year Analysis

All of the study intersections except the Villa Road/HWY 99 intersection are forecast to meet operation standards during the weekday p.m. peak hour. The site is anticipated to be built out in 2016.

- Without development of the site, the intersection of Highway 99 and Villa Road will exceed capacity (ODOT's standard is a v/c ratio of 0.85). The intersection will operate at a v/c of 0.88.
- With development of the site, the intersection of Villa Road and HWY 99 will still operate at a v/c of 0.88. The development's impact to this intersection is minimal. All other study intersections operate at acceptable LOS. If the site is developed in 2016 then no mitigation would be needed at the study intersections.

2035 Year Analysis

All of the study intersections except the Villa Road/HWY 99 intersection and the Villa Road/Fulton Street intersection are forecast to meet operation standards during the weekday p.m. peak hour.

- Without development of the site, the Villa Road/HWY 99 intersection is forecast to operate with a v/c ratio of 1.11 which exceeds the ODOT standard of 0.85, and the Villa Road/Fulton Street intersection is forecast to operate with a LOS F which exceeds the City's standard of LOS D or better.
- With development of the site, all of the study intersections except the Villa Road/HWY 99 and Villa Road/Fulton Street intersections are forecast to continue meeting operational standards during the weekday p.m. peak hour. With full development of the site, the v/c ratio of the Villa Road/HWY 99 intersection is forecast to operate at 1.12 which is an increase of 0.01 from the undeveloped conditions. The impact of this development on that intersection is minimal, and no mitigation is proposed. ODOT has commented that the impact on state facilities is limited, and they had no additional requirements. No mitigation would be required for this project at the Villa/Fulton intersection, as the intersection will operate acceptably in 2016 upon development. The decrease in LOS to F for Villa/Fulton in 2035 is due to the increase in background traffic, as the intersection is expected to have a LOS of F in 2035 whether or not this site is developed. Appropriate changes to the traffic control at that intersection will be considered at that time.

No mitigation will be required at nearby intersections. The applicant is still responsible for the cost of street frontage improvements on Park Lane and Villa Road, however, and will also pay Transportation SDCs toward their general impact on the transportation system (the current transportation SDC is \$2,143.68 per multifamily dwelling unit, so this becomes a significant cost

for a project with 128 dwelling units). SDC rates increase over time, so the actual SDC to the applicant will depend on when development occurs.

- **Sight Distance:** The sight distance from the proposed site's frontage on Park Lane is adequate for cars entering and exiting the site. The sight distance from the proposed site's Villa Road frontage may not be adequate depending on the final profile and alignment of Villa Road. If adequate sight distance is not possible, the Villa Road access will be limited to right in/right out movements only. Villa Road is proposed to continue as a 25 MPH road through the developments frontage and through the large sag vertical curve to the south of the property. Excessive speeds are a concern in this area. To help mitigate this problem, a landscaped median (or other approved traffic calming measure) in a portion of the site's Villa Road frontage will be required at the time of development. This can also serve to provide right in/right out access restrictions at the Villa Road driveway access.
- **Public utility infrastructure:** The proposed site has existing water and stormwater facilities to serve the maximum density of the proposed zone change. There is an existing 8" waterline in Villa Road and Park Lane and there is a 21" stormwater line at the southern boundary of the property. The application contains a report on the water system which shows adequate capacity. The post developed stormwater runoff rates will match pre-developed rates with properly designed stormwater facilities.

The existing sewer system directly downstream of the site is currently at capacity and development of the site at the existing R-1 zoning density would put several pipe segments over capacity. A change in zoning from R-1 to R-3 would not significantly increase the demand on the sewer system, and would not require a larger pipe size than is required with the current zoning. The specifics of pipe upsizing would be determined during development application review.

- **Availability of public services:** The proposed site is within walking distance of many services: Within ¼ mile of a small CPRD park (College Park, off Sierra Vista), the CPRD pool, and George Fox University; within ½ mile of Joan Austin Elementary school; within ¾ mile of Newberg High School, and the Portland Road commercial area. This meets the Comprehensive Plan policies of high density housing being located near public services and public open spaces. It also means that residents of the proposed high density housing may walk or bike to commercial areas, jobs, parks, and schools. Public transit is available on Hwy 99W. An apartment project would help fund these services by paying a School District construction excise tax (currently \$1 per square foot for residential construction) and a Parks District SDC (currently \$1,475 per dwelling unit).

PRELIMINARY STAFF RECOMMENDATION: The preliminary staff recommendation is made in the absence of public hearing testimony, and may be modified subsequent to the close of the public hearing. At this writing, staff recommends the following motion:

Move to adopt Planning Commission Resolution 2015-307, which recommends that the City Council approve the requested Comprehensive Plan map change from LDR to HDR and Zone change from R-1 to R-3.



PLANNING COMMISSION RESOLUTION 2015-307

A RESOLUTION OF THE PLANNING COMMISSION OF THE CITY OF NEWBERG RECOMMENDING THAT THE CITY COUNCIL APPROVE FILE CPA-15-001/ZMA3-15-001, WHICH WOULD AMEND THE COMPREHENSIVE PLAN DESIGNATION FROM LDR (LOW DENSITY RESIDENTIAL) TO HDR (HIGH DENSITY RESIDENTIAL) AND AMEND THE ZONING DESIGNATION FROM R-1 (LOW DENSITY RESIDENTIAL) TO R-3 (HIGH DENSITY RESIDENTIAL) FOR A PROPERTY LOCATED AT 1317 VILLA ROAD, YAMHILL COUNTY TAX LOT 3217BC-800.

RECITALS

1. DJ2 Holdings, LLC submitted an application requesting a Comprehensive Plan map amendment from LDR (Low Density Residential) to HDR (High Density Residential) and a Zoning map amendment from R-1 (Low Density Residential) to R-3 (High Density Residential) for property located at 1317 Villa Road, Yamhill County tax lot 3217BC-800.
2. After proper notice, the Newberg Planning Commission held a hearing on May 14, 2015 to consider the application. The Commission considered testimony, and deliberated.
3. The Newberg Planning Commission finds that the application meets the applicable criteria from the Newberg Development Code, and the goals and policies of the Newberg Comprehensive Plan as shown in the findings shown in Exhibit A.

The Newberg Planning Commission resolves as follows:

1. The Planning Commission recommends that the City Council amend the Comprehensive Plan map and Zoning map to include the property shown in Exhibit B and described in Exhibit C in the HDR comprehensive plan district and the R-3 zoning district. Exhibits B and C are hereby adopted and by this reference incorporated.
2. This recommendation is based on the findings shown in Exhibit A. Exhibit A is hereby adopted and by this reference incorporated.

Adopted by the Newberg Planning Commission this 14th day of May, 2015.

ATTEST:

Planning Commission Chair

Planning Commission Secretary

List of Exhibits:

- Exhibit "A": Findings
- Exhibit "B": Location map
- Exhibit "C": Legal description
- Exhibit "D": Comprehensive Plan map
- Exhibit "E": Zoning map

"Working Together For A Better Community-Serious About Service"

Z:\WPSFILES\FILES.CPA\2015\CPA-15-001.ZMA3-15-001 Martell Commons\PC staff report.resolution.findings\Staff report, resolution, findings\PC Resolution 2015-307 Martell.doc

**1317 Villa Road Comprehensive Plan Map Amendment & Zoning Amendment,
File: CPA-15-001/ZMA3-15-001**

**Section I. Newberg Development Code § 151.122: Procedures for
Comprehensive Plan Map and Zoning Map Amendments.**

(A) Type III Plan and zoning map amendments – one parcel or small group of parcels.

(3) Amendment Criteria. The applicant must demonstrate compliance with the following criteria:

(a) The proposed change is consistent with and promotes the goals and policies of the Newberg Comprehensive Plan and this Code;

Finding: Section II of these findings addresses the Comprehensive Plan goals and policies. It can be found that this proposal is consistent with and promotes numerous applicable goals and policies, as summarized below.

Density: The site contains 5.94 acres, or 258,746 square feet. Assuming that the net site area after right-of-way dedications will be approximately 85% of the gross area, there would be an approximate net site area of 219,934 square feet. If the site develops as R-1 it would be expected to have approximately 30 single family homes. In the R-3 zone the site would allow an approximate maximum net density of 147 dwelling units and a minimum of 88 dwelling units. The actual density will depend on the final site design and will be limited by parking requirements, open space requirements, and stormwater facilities, but is expected by the applicant to be approximately 128 units.

15.302.032 Purposes of each zoning district.

A. R-1 Low Density Residential District.

- 1. The purpose of this land use designation is to provide for low density urban single-family residential uses at an average overall density of 4.4 units per gross buildable acre in the district. It is intended to provide a stable and healthful environment together with the full range of urban services.*
- 2. Typical housing types will include single-family dwellings and planned unit developments. The district also is intended to allow low intensity institutional uses that operate consistent with peaceful enjoyment of residential neighborhoods. The R-1 district is intended to be consistent with the low density residential (LDR) designation of the comprehensive plan.*

C. R-3 High Density Residential District.

- 1. The purpose of this land use designation is to provide multifamily dwellings of different types and styles at an average overall density of 16.5 units per gross buildable acre in the district.*

2. Typical housing types will include duplexes, multifamily dwellings, and manufactured dwelling and mobile home parks. The district also is intended to allow low intensity institutional uses that operate consistent with peaceful enjoyment of residential neighborhoods. Density may vary depending on lot size, off-street parking area, transportation, landscaping and other site considerations. The R-3 district is intended to be consistent with the high density residential (HDR) designation of the comprehensive plan.

Comprehensive Plan Housing Land Needs and Buildable Land Supply History

Newberg’s Comprehensive Plan has consistently shown a significant need for additional HDR (High Density Residential) land.

2005 Comprehensive Plan Land Need and Supply Amendments

In 2005, the City Council adopted amendments to the Comprehensive Plan, including updated residential land need and supply numbers for LDR (Low Density Residential), MDR (Medium Density Residential) and HDR (High Density Residential) land designations. The updates were based on data from the Housing and Residential Land Needs Report compiled by Johnson-Gardner in 2004. The amendments were adopted and acknowledged through the post-acknowledgment plan amendment process in 2005. The 2005 Comprehensive Plan has residential land data for the 20-year period from 2005-2025, and the future planning period out to 2040. That data shows that the City had a demonstrated need for 89 buildable acres of HDR (High Density Residential) through 2025, and an additional 83 acres of HDR land through 2040:

Plan Designation	Buildable Acres Needed 2005-2025	Buildable Acres in UGB (2004)	Surplus (Deficit) for 2005-2025	Buildable Acres Needed 2026-2040
LDR	612	359	(253)	735
MDR	173	142	(31)	191
HDR	89	13	(76)	83
Total	874	514	(380)	1009

Source: Newberg Ordinance 2005-2626

In 2009 the City proposed an update to the Housing Element of the Comprehensive Plan. This item was appealed to LUBA and remanded; it has not yet been revised and readopted, so the 2005 amendments are the latest acknowledged estimates.

This application: For the purposes of this application, the firm of Cogan Owens Greene prepared a housing needs analysis using recent data on buildable lands, and a 2012 population projection for Newberg that has been adopted by Yamhill County as part of a coordinated population projection for every part of Yamhill County.

Excerpted from the application – Population Forecast:

Portland State University’s Population Research Center developed a future population forecast for the Newberg Urban Area. This forecast was adopted by Yamhill County as the coordinated population forecast required by state law. This forecast is shown in Table III-2.

Table III-2. Future Population Forecast – Newberg Urban Area

Year	Population Forecast
2015	24,663
2020	28,250 (corrected by city staff – the applicant used 25,250, which was a typographical error)
2025	32,213
2030	35,408
2032	36,610
2035	38,490

Source: Population Research Center, Portland State University, Population Forecasts for Yamhill County, its Cities and Unincorporated Area, 2011-2035, 2012.

Excerpted from the application – Housing Needs Analysis:

*Cogan Owens Greene prepared a Housing Needs Analysis (Exhibit G) based on the 2009 inventory updated with current GIS data provided by City Staff, the projections from the Portland State Report, and refined for the remand findings from LUBA. This supplemental report is included in Exhibit G. It confirms that there will be a shortage of land available in **2030** for LDR, MDR, and HDR lands:*

Plan Designation	Buildable Acres Needed	Buildable Acres in UGB	(Deficit)	Percentage of Available Capacity
LDR	406	369	(37)	91%
MDR	179	92	(87)	51%
HDR	62	7	(55)	11%
Total	647	468	(179)	72%

The proposed amendment would add 5.94 acres of HDR land to the buildable land inventory. This would meet about 10% of the HDR need through 2030. The proposed amendment would decrease the amount of buildable LDR land by 5.94 acres, or 1.5% of the LDR need through 2030. The city needs to have an adequate supply of all types of land. This change from LDR to HDR is justified because there is currently a greater shortfall in HDR.

Adequate Infrastructure to Serve the Site

The applicant included an Infrastructure Analysis report. The proposed site has existing water and stormwater facilities to serve the maximum density of the proposed zone change. There is an existing 8” waterline in Villa Road and Park Lane and there is a 21” stormwater line at the southern boundary of the property. The application contains a report on the water system which shows adequate capacity. The post developed stormwater runoff rates will match pre-developed rates with properly designed stormwater facilities.

The existing sewer system directly downstream of the site is currently at capacity and development of the site at the existing R-1 zoning would put several pipe segments over capacity. A change in zone from R-1 to R-3 would not significantly increase the demand on the sewer system, and would not require a larger pipe size than is

required with the current zoning. The specifics of pipe upsizing would be determined during development application review.

The proposed development site is located adjacent to Villa Road and Park Lane and would take direct access from both streets. Park Lane is currently developed below City residential street standards. The development would construct a 1/2 street improvement on the south side of Park Lane to residential standards. Villa Road is currently developed below City major collector standards. The development would construct a 1/2 street improvement on the west side of Villa Road to major collector standards. Right-of-way dedication would be required along both street frontages; the extent of dedication would be determined at the design review phase.

The City is currently beginning design of transportation improvements to Villa Road from Hayworth Avenue to Crestview Drive as a planned Capital Improvement Project. The project intends to improve the vertical alignment of the road and complete multimodal improvements along Villa. During the development application review, coordination of street improvements will be necessary, and will be completed at that time.

According to the applicant's traffic impact study, all of the study intersections except the Villa Road/HWY 99 intersection are forecast to meet operation standards during the weekday p.m. peak hour at the time of development in 2016. The impact of this development on that intersection is minimal and no mitigation is proposed at the time of development. No mitigation would be required at study intersections upon development in 2016. In the year 2035, all of the study intersections except the Villa Road/HWY 99 intersection and the Villa Road/Fulton Street intersection are forecast to meet operation standards during the weekday p.m. peak hour. The impact of this development on those intersections in the year 2035 is minimal and no mitigation is necessary. ODOT has commented that the impact of the development at the Villa/99W intersection is limited, and had no additional comments or requirements.

Availability of Public Services

The proposed site is within walking distance of many services: Within ¼ mile of a small CPRD park (College Park, off Sierra Vista), the CPRD pool, and George Fox University; within ½ mile of Joan Austin Elementary school; within ¾ mile of Newberg High School, A-dec's industrial site, and the Portland Road commercial area. This meets the Comprehensive Plan policies of high density housing being located near public services and public open spaces. It also means that residents of the proposed high density housing may walk or bike to commercial areas, jobs, parks, and schools. Public transit is available on Highway 99W.

Site is Suitable for HDR Development

The proposed site is suitable for HDR development because it meets the Comprehensive Plan policies of high density housing location, dispersal of high density housing, design of high density housing, and compatibility with surrounding development. The proposed site is adjacent to a major collector road which will provide adequate access for higher density housing. There are few apartments north of the railroad tracks, so approval would help the dispersal of R-3 housing within the city. Future development on the site will be compatible with the surrounding area due to the design review criteria for multifamily housing and due to setbacks, lot coverage limits, height limits, and landscaping buffer requirements. For example, the maximum permitted building height in R-3 is limited to 30 feet (the same maximum height as R-1) for a distance of 50 feet from the abutting

boundary of a R-1 district. This ensures that building heights in R-3 will be compatible with abutting R-1 properties.

The application meets this criterion because the proposed change from LDR/R-1 to HDR/R-3 is consistent with many goals and policies in the Comprehensive Plan, and the Development Code.

(b) Public facilities and services are or can be reasonably made available to support the uses allowed by the proposed change.

Finding: The application included an Infrastructure Analysis report. Public facilities and services are available to support the proposed uses. There is an existing 10-inch and 12-inch sanitary sewer line to the property, with a manhole connection at the southern edge of the property. The applicant's sanitary sewer calculations report indicates, and City staff concurs, that there is not adequate capacity in the downstream sanitary sewer system to support further development, but that the sewer system can be upsized to support the development. The sanitary sewer master plan identifies the necessary pipe size required to serve the basin if fully developed with current zoning. The zone change at the maximum density does not change the needed pipe diameter needed for development in the basin. There are existing water lines in Villa Road and Park Lane. A fire flow analysis will be completed at the time of development and water pipe upsizing will be completed with the development. There is adequate capacity to the site which can be reasonably provided through the City's water storage and distribution system. There is an existing 21" stormwater line at the southern boundary of the site which could serve the site.

The site is accessed by Park Lane and Villa Road, both of which are not fully improved streets. A 1/2 street improvement on Park Lane and Villa Road will be required at the time of development. Additional right of way dedication will also be required. Park Lane is a residential street with an ultimate curb-to-curb width of 32 feet. Villa Road is a Major Collector with an ultimate curb-to-curb width of 34 feet with two 12-foot travel lanes, 5-foot bike lanes, and setback sidewalk. Portions of Villa Road may include a landscaped median. No parking will be allowed on Villa Road. According to the applicant's traffic impact study, all of the study intersections except the Villa Road/HWY 99 intersection are forecast to meet operation standards during the weekday p.m. peak hour at the time of development in 2016. The impact of this development on that intersection is minimal and no mitigation is proposed at the time of development. In the year 2035, all of the study intersections except the Villa Road/HWY 99 intersection and the Villa Road/Fulton Street intersection are forecast to meet operation standards during the weekday p.m. peak hour. The impact of this development on the Villa Road/Hwy 99W intersection and the Villa/Fulton intersection in the year 2035 is minimal and no mitigation is necessary. The increase in traffic at both of these intersections in 2035 is primarily due to the increase in background traffic.

The application meets this criterion because public facilities and services are or can be reasonably made available to support the uses allowed by the proposed change from LDR/R-1 to HDR/R-3.

(c) Compliance with the State Transportation Planning Rule (OAR 660-012-0060) for proposals that significantly affect transportation facilities.

Finding: The State Transportation Planning Rule is meant to determine whether proposals “significantly affect” existing or planned transportation facilities, and if they do affect them, to ensure that they are properly mitigated. The Rule says that:

“a plan or land use regulation amendment significantly affects a transportation facility if it would: (a) Change the functional classification of an existing or planned transportation facility; (b) Change standards implementing a functional classification system; or (c) As measured at the end of the planning period identified in the adopted transportation system plan: (A) Allow land uses or levels of development that would result in types of levels of travel or access that are inconsistent with the functional classification of an existing or planned transportation facility; (B) Reduce the performance of an existing or planned transportation facility below the minimum acceptable performance standard identified in the TSP or comprehensive plan; or (C) Worsen the performance of an existing or planned transportation facility that is otherwise projected to perform below the minimum acceptable performance standard identified in the TSP or comprehensive plan.”

The proposed plan amendment site is located adjacent to Villa Road, which is classified as a Major Collector in the City’s Transportation System Plan, and Park Lane, which is classified as a Residential Street in the City’s Transportation System Plan. The proposal would not: (a) change the functional classification of Villa Road or Park Lane; or (b) change standards implementing a functional classification system.

One of the main purposes of the traffic impact study included with the applicant’s application package is to determine whether the project meets subsection (c) of the Transportation Planning Rule. The traffic study analyzed the trip generation and distribution, safety analysis, and operational analysis of the proposed project to determine the impact the proposal will have on the transportation system. The trip generation is based on the maximum possible gross density allowed by the proposed zone; in this case that would be 168 possible dwelling units. That number is compared with the trips that would be generated by the possible maximum density allowed by the R-1 zone, 30 units. The traffic study indicates that the proposed zone change could result in a net increase of 74 trips during the evening peak hour, with 25 exiting the site and 49 entering the site. In the morning peak hour, the maximum density could result in a net increase of 55 trips, with 9 entering and 46 exiting the site. The actual trips generated by the site may be fewer due to the unlikelihood of the site being built out at the maximum density – with the topographic and environmental constraints, the site build out will more likely be around 128 units.

Sight distance from the site frontage was examined and determined to be adequate along Park Lane. Sight distance from the site frontage along Villa Road is not adequate. Depending on the ultimate vertical and horizontal profiles of Villa Road, the Villa Road access may be limited to right in/right out access only. A landscaped median would be installed on Villa Road to facilitate this restriction, as well as to provide for some natural traffic calming.

During a five year period between January 2009 and December 2013, there were no accidents reported at any of the study intersections except for the Villa Road/HWY 99 intersection. At this intersection there were 33 crashes, 24 of which were rear-end collisions. The crash rate per million entering vehicles at this intersection was below 1.0. Additionally, the crash history for the segment of Villa Road, not including the study intersections, was analyzed between Park Lane and HWY 99. Of the four crashes reported in this segment, three involved bicycles. Bicycle and pedestrian improvements are planned for the development, which will help mitigate the bicycle incidents. No mitigations are proposed for the Villa Road/HWY 99 intersection.

The traffic study also looked at capacity analysis for the area and surrounding intersections for the expected project build-out in 2016 and to 2035. Capacity analysis looks at the volume-to-capacity (v/c) ratio for intersections; in other words, how much traffic an intersection can handle before it's at peak capacity, which would be a ratio of 1.0. The intersection is then given a letter grade ranging from A (best) to F (worst) for its level of service based on the v/c ratio for the intersection. The traffic study analysis shows that all of the surrounding intersections are operating at an acceptable level of service under all analysis scenarios, except for the Villa Road/HWY99 intersection in 2016 and 2035, and the Villa Road/Fulton Street intersection in 2035.

- With full build out in 2016, the Villa Road/HWY 99 intersection is forecast to operate at a v/c ratio of 0.88 which is over the ODOT standard of 0.85. Without this development, the v/c ratio would be 0.88. The impact of this development is minimal at this intersection. In the 2035 analysis, the Villa Road/HWY 99 intersection is forecasted to operate at a v/c ratio of 1.12 with full development of the site and 1.11 without development of the site. This also is a minimal impact and no mitigations is proposed. ODOT has confirmed this by stating that the project will have a limited impact on state facilities, and did not have any additional comments.
- The intersection of Villa Road/Fulton Street in 2035 is anticipated to have a level of service of F with or without full build out of this proposed development. However, at the 2016 build-out, the Villa Road/Fulton intersection is forecast to operate at a level of service D, which is within City standards. Because of this, no mitigation to this intersection is anticipated at the time of development until a future date when the intersection warrants mitigation.

According to the traffic study, the future trips generated from the proposed zone change will not “significantly affect” the transportation system. Less than 400 of the additional daily trips are anticipated to reach the Villa/99W intersection, which under the Oregon Highway Plan standards does not cause “further degradation” of state highway facilities. ODOT has stated that the project will have a limited impact on state facilities, and did not have additional comments or requirements. Therefore, the proposal meets the State Transportation Planning Rule because it does not significantly affect transportation facilities: (A) It does not allow a level of development that would result in levels of travel inconsistent with the functional classification of the existing transportation facilities; (B) It does not reduce the performance of the existing transportation facilities below the minimum acceptable performance standards; and (C) It does not significantly worsen the performance of an existing transportation facility that is otherwise projected to perform below the minimum acceptable performance standard.

Section II. Applicable Statewide Planning Goals and Newberg Comprehensive Plan Goals & Policies

A. Citizen Involvement Goal

Goal: To maintain a Citizen Involvement Program that offers citizens the opportunity for involvement in all phases of the planning process.

Finding: Part of the citizen involvement program includes opportunities for citizen involvement in planning. In this case, citizens have an opportunity to comment on this proposal, both in writing and by testifying at either the Planning Commission or City Council hearings. In addition, the applicant for this proposal held a neighborhood meeting for the purpose of discussing the project with neighbors before the official public process started. This application is consistent with this goal because the public hearing process offers citizens the opportunity to comment on the proposal, and appeal the decision if they are unsatisfied.

Statewide Planning Goal 10: To provide for the housing needs of citizens of the state.

Buildable lands for residential use shall be inventoried and plans shall encourage the availability of adequate numbers of needed housing units at price ranges and rent levels which are commensurate with the financial capabilities of Oregon households and allow for flexibility of housing location, type and density.

NCP I. Housing Goals and Policies

Goal: To provide for a diversity in the type, density and location of housing within the City to ensure there is an adequate supply of affordable housing units to meet the needs of City residents of various income levels.

2. Location Policies. a: Medium and high density areas should be located for immediate access to collector streets or minor arterials and should not cause traffic to move through low density areas. High density areas should be easily accessible to arterial streets. They should also be located near commercial services and public open spaces.

3. Mix Policies. b: Low and moderate income housing should not be concentrated within particular areas of the City.

3.j: The City shall encourage innovation in housing types and design as a means of offering a greater variety of housing and reducing housing costs.

3.k: The City shall encourage an adequate supply of rental housing dispersed throughout the city to meet the needs of renters.

Finding:

The City has an obligation, reflected here in the comprehensive plan policies, to ensure that there is adequate housing of all density types and for every income level. The proposed zone change would help the City remedy its deficit of available multi-family housing.

The proposed site is located adjacent to a major collector, and most traffic from the site is expected to use Villa Road, not local residential streets. Villa Road gives easy access to Portland Road/Hwy 99W, a major arterial. In addition, the site is within walking distance of many services: Within ¼ mile of a small CPRD park (College Park, off Sierra Vista), the CPRD pool, and George Fox University; within ½ mile of Joan Austin Elementary school; within ¾ mile of Newberg High School, A-dec's industrial site, and the Portland Road commercial area. This meets the Comprehensive Plan policies of high density housing being located near public services and public open spaces. It also means that residents of the proposed high density housing may walk or bike to commercial areas, jobs, parks, and schools. Public transit is available on Highway 99W.

Any future development on the site under the proposed R-3 zoning will require a design review process where the applicant will need to meet not only the basic design review criteria, but also the additional multi-family design review criteria. The City would have future opportunities to influence the design of the development and encourage innovation of housing types and design. The proposal is consistent with many of the housing policies in the Comprehensive Plan.

J. Urban Design Goals and Policies

Goal 1: To maintain and improve the natural beauty and visual character of the City.

1. General Policies. b: Design review should be provided for all new developments more intensive than duplex residential use.

1.1.l: The City shall encourage compatible architectural design of new structures in the community.

1.1.n: The City shall encourage innovative design and ensure that developments consider site characteristics and the impact on surrounding areas.

1.1.r: Developments of medium or high density shall be of a quality and design which will effectively offset the greater density.

Finding: Any future development on this property under the proposed R-3 zoning will require design review approval. The Newberg Development Code also has supplementary design review standards that multi-family developments must meet, including compatibility with adjacent sites. The site characteristics for future development would be looked at closely to encourage the best design of the property and to properly mitigate any impacts on surrounding uses. The proposal is consistent with many of the urban design goals and policies in the Comprehensive Plan.

K. Transportation Goals and Policies

Goal 3: Promote reliance on multiple modes of transportation and reduce reliance on the automobile.

Policy b.2: The City shall encourage higher density development in residential areas near transit corridors, commercial areas and employment centers, including the downtown.

Finding: The site is within walking distance of many services: Within ¼ mile of a small CPRD park (College Park, off Sierra Vista), the CPRD pool, and George Fox University; within ½ mile of Joan Austin Elementary school; within ¾ mile of Newberg High School, A-dec's industrial site, and the Portland Road commercial area. This

means that residents of the proposed high density housing may walk or bike to commercial areas, jobs, parks, and schools. Public transit is available on Highway 99W. The proposal is consistent with transportation goals and policies in the Comprehensive Plan.

L. Public Facilities and Services Goals and Policies

Goal: To plan and develop a timely, orderly and efficient arrangement of public facilities and services to serve as a framework for urban development.

1. All Facilities & Services Policies. f: Maximum efficiency for existing urban facilities and services will be encouraged though infill of vacant City land.

2. Sewers and Water Policies. c: Developments with urban densities should be encouraged to locate within the area which can be serviced by Newberg's present sanitary sewer system.

Finding: It is appropriate to use land within the city limits to its highest and best use in order to preserve the efficiency of public facilities to serve urban development. The proposed site has existing sewer and water facilities available, and with reasonable improvements can have adequate capacity to serve the maximum density of the proposed zone change. It is more efficient to use an existing site such as this as opposed to extending new public utilities to an undeveloped vacant parcel without such services.

There is an existing 12-inch sewer line with a manhole at the Southern property edge in Villa Road. The application contains a report on sanitary sewer calculations done by 3J Engineering, calculating the demand flow of the existing sewer line with existing & potential maximum R-1 density (1,225-gmp) and existing & potential maximum R-3 density (1,242-gmp). The total existing flow in the 12-inch sewer, based on the City's master plan, is approximately 1,203-gpm. While the zone change would create a slight increase in sewer flows, the relative increase to the existing system is only 3.2%, and only 1.4% over the allowed R-1 zoning. Therefore, the 12" sewer pipe is currently at capacity, and any development of this site would place this pipe and downstream pipes over capacity. The City's master plan identifies segments of pipe in this area to be upsized to an 18" pipe. As part of the development application, the applicant will study the flows in these pipe segments to verify the master plan. Several segments of pipe may need to be upsized as part of the development.

Finding: Overall, the proposal is consistent with many goals and policies in the Comprehensive Plan regarding public participation, housing, urban design, transportation, and public facilities.

Exhibit B: Location Map

Reference Parcel #: R3217BC 00800

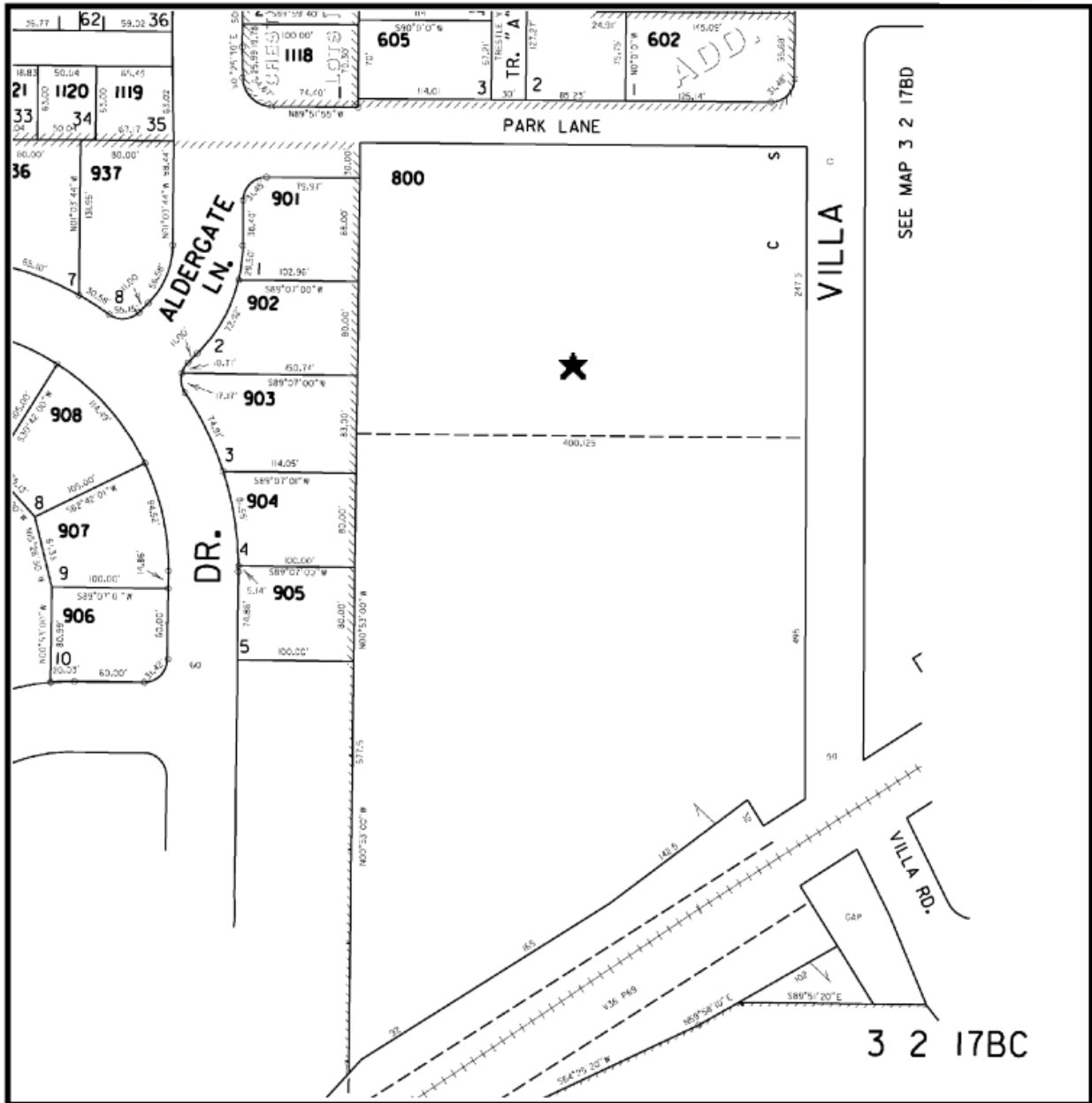

Exhibit C: Legal Description

Parcel 1

Being a part of the D. D. Deskins and O. J. Walker Donation Land Claims, in Section 17, Township 3 South Range 2 West in Yamhill County, Oregon, and described as follows, to-wit: Beginning at a point on the South line of the O. J. Walker D. L.C., said point being 104 rods East of the West side of Section 17; thence North 30 rods to South line of ten acre tract deeded to Ervin Scott; thence West 24 ¼ rods; thence South parallel with East line 35 rods, more or less to the North line of the R. R. right of way; thence Northeasterly along said right of way to intersection of the South line of the O. J. Walker D.L.C.; thence East to place of beginning, excepting R.R. right of way through said premises.

Also the following tract: Being a part of the O. J. Walker D.L.C. in section 17, Township 3 South, Range 2 West Yamhill County, Oregon, described as follows: Beginning at a point 64 rods West of the Southeast corner of said Claim, thence running West 5 rods to the Southeast corner of Jos. Hoskins land; thence North 6 rods to the South line of the P. and W.V.R.R.; thence running Easterly along said South line of the P. and W.V.R.R. 3 ½ rods; thence running Southeasterly about 7 or 8 rods to the place of beginning, containing 30/160 acres more or less.

The above two tracts of land containing in all about 5 acres more or less, excepting R.R. right of way.

Parcel 2

A tract of land located in Yamhill County, Oregon, and being a part of the Donation Land Claim of Oliver J. Walker in Township 3 South, Range 2 West of the Willamette Meridian in Yamhill County, and more particularly described as follows:

Beginning at a point 30 rods North of the South boundary line of said Claim and 104 rods East of the Section line between Sections 17 and 18 in said Township and Range; and said point being at the Southeast corner of that certain tract of land conveyed to Ervin Scott by J. L. Hoskins and Mary L. Hoskins by deed recorded at Page 281 in Book 31 of Deed Records of Yamhill County, and running thence West 24-1/4 rods; thence North 15 rods; thence East 24-1/4 rods; thence South 15 rods to the place of beginning.

Exhibit D: Comprehensive Plan Map

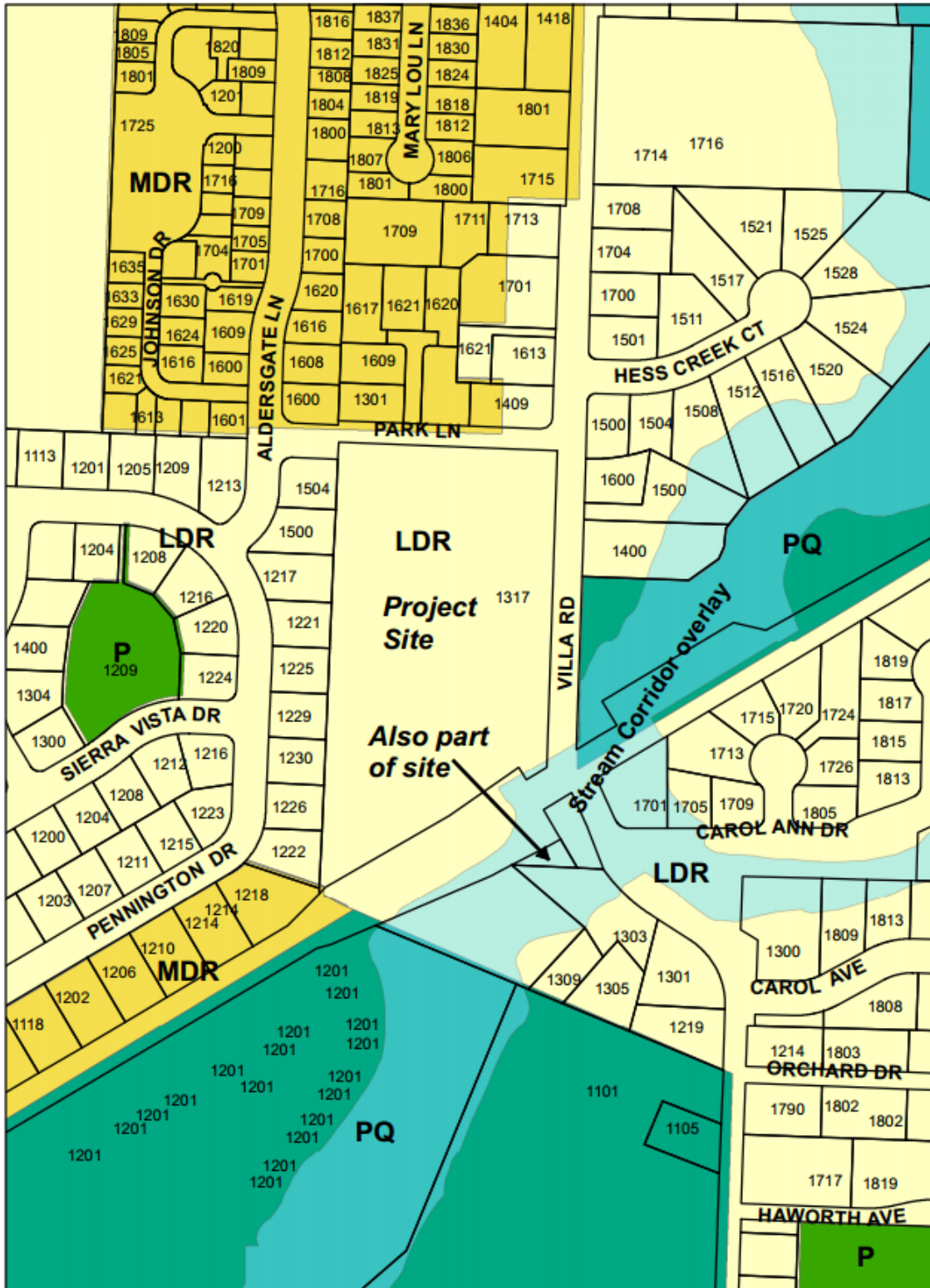
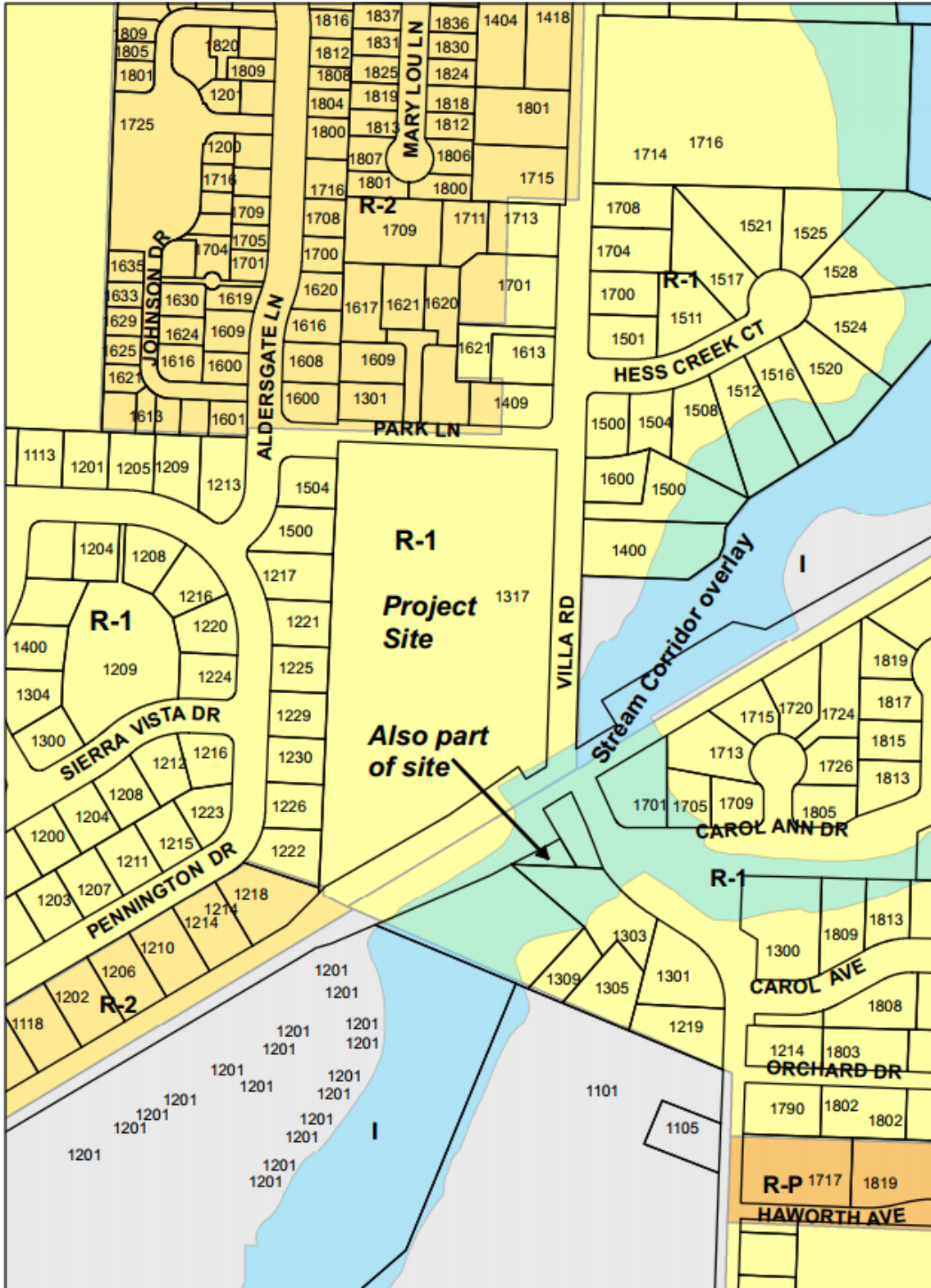

Exhibit E: Zoning Map



Steve Olson

From: DOWNING Andrea <andrea.downing@state.or.us>
Sent: Tuesday, April 21, 2015 11:05 AM
To: Steve Olson; jeff@dj2holdings.com
Subject: WLUN #2015-0115 Response to CPA-15-001/ZMA3-15-001
Attachments: WN2015-0115-Notice.pdf; WN2015-0115-Response.pdf

We have completed our review of the Wetland Land Use Notification that was prepared for **DJ2 Holdings LLC and Martell Family Farms LLC**. The WLUN form was submitted to the Department for review/response and given the file number **WN2015-0115**.

The results and conclusions from that review are explained in the attached pdf documents. If the attached documents are illegible or difficult to open, you may contact the Department and request paper copies. Otherwise, please review the attachments carefully and direct any questions or comments to Wetland Specialist, Chris Stevenson at (503) 986-5246 or Christine.stevenson@dsl.state.or.us . Thank you for your interest in the project.

Oregon Department of State Lands
Aquatic Resource Management Program
775 Summer Street NE #100
Salem, OR 97301
503-986-5235 direct
Andrea.Downing@dsl.state.or.us



WETLAND LAND USE NOTIFICATION RESPONSE
 OREGON DEPARTMENT OF STATE LANDS
 775 Summer Street NE, Suite 100, Salem, OR 97301-1279
 Phone (503) 986-5200
www.oregonstatelands.us

DSL File Number: WN2015-0115

Cities and counties have a responsibility to notify the Department of State Lands (DSL) of certain activities proposed within wetlands mapped on the Statewide Wetlands Inventory. Steve Olson from city of Newberg submitted a WLUN pertaining to local case file #: CPA-15-001, ZMA3-15-001.

Activity location:

township: 03S	range: 02W	section: 17	quarter-quarter section: BC
tax lot(s): 800			
street address: 1317 Villa Rd			
city: Newberg		county: Yamhill	
latitude: 45.310122		longitude: -122.964962	

Mapped wetland/waterway features:

Oregon Removal-Fill requirement (s):

A state permit is required for 50 cubic yards or more of removal and/or fill in wetlands, below ordinary high water of streams, within other waters of the state, or below highest measured tide where applicable.

Your activity:

A state permit will not be required for the proposed project because based on the submitted site plan the project appears to avoid impacts to jurisdictional wetlands and waters.

Contacts:

This is a preliminary jurisdictional determination and is advisory only.

Comments: Based on a review of the available information, it does not appear that the proposed development will impact jurisdictional wetlands or waterways.

Response by: Cherie Stevenson date: 04/20/2015

Steve Olson

From: FRICKE Daniel L <Daniel.L.FRICKE@odot.state.or.us>
Sent: Monday, May 04, 2015 7:58 AM
To: Steve Olson
Cc: JUSTER Gerard P *Gerry
Subject: ODOT Comments on Project at 1317 Villa Road (CPA-15-001/ZMA-3-15-001)

Steve –

Gerry Juster and I have reviewed this application and have determined that ODOT will not have any comments. This is due to the limited impact we expect the project will have on state facilities. Thank you for referring this application to ODOT for review. Please feel free to contact me or Gerry if you have questions or need additional information.

***Dan Fricke, Senior Transportation Planner
Oregon Department of Transportation
Region 2
455 Airport Road SE Building B
Salem, OR 97301-5395
Ph: 503-986-2663 Fax: 503-986-2840
e-mail: daniel.l.fricke@odot.state.or.us***



**Newberg-Dundee
Police Department**
P. O. Box 970
401 E. Third Street
Newberg, OR 97132
503-538-8321
Brian T. Casey
Chief of Police

**To: Chief Brian Casey
Planning and Building Department**

From: Chris Bolek

Re: Martell Commons Comprehensive Plan Amendment and Zone Change Proposal

Date: April 17, 2015

Thank you for allowing me an opportunity to offer input.

The issues of concern that I see have to do with pedestrian / vehicle mixed use safety, parking and the number of intersections or driveways within such close proximity of one another.

In your decision making process of this Zone Change Proposal for the construction of a 128 unit apartment complex, I would ask for the following matters to be considered:

- It appears to be on the plan but I am not certain. However, Park Lane must be widened to safely handle the proposed number of vehicles and pedestrian traffic.
- As noted, this zone change if allowed has a planned use for this property for the construction of a 128 unit apartment complex, with 227 planned parking spaces, an on-site parking ratio of 1.77 parking spaces per unit. This seems adequate but inevitably vehicles belonging to residents and guests will be parked on the street. Therefore to limit /minimize congestion, I would encourage no parking on the north side of the street where the existing homes are located.
- Appropriate and adequate parking restrictions so as to not block alleys, with adequate signage that gives police the necessary tools to help residents with parking issues.
- I recognize that one of the City's goals is to promote reliance on multiple modes of transportation, and to encourage higher density development in residential areas. The applicant has identified in their response to this goal (page 17) that this development is within walking and biking distance to GFU, Joan Austin Elementary, Chehalem Aquatic Center and Hwy 99w, among other features. What is important to note is that GFU and the Aquatic Center are south of this proposed development and the main route of travel will be Villa Rd. Page 18 of the

document indicates that pedestrian and bicycle improvements are proposed with the development along Villa Road and the completion of a continuous pedestrian route from the rezone site to GFU. While I am not clear what a "pedestrian route" is as opposed to sidewalks, I do believe that it is extremely important that this area be improved to maximize pedestrian and bicyclist safety especially with the train trestle and limited visibility of pedestrian and bicycle traffic for southbound vehicles on Villa Rd as vehicles enter the curves south of Carol Avenue and north of the train trestle.

- I am concerned as to whether or not the west side of Villa Rd between the rezone area and Crestview Drive will be developed. The development is situated on the west side of Villa Rd. For elementary school aged youth walking or biking to Joan Austin, it is a reasonable expectation that those youth will leave from their home and travel north on Villa Rd along the west side and without improvements north of the rezoning / development, this will not be a safe scenario.

On this note, I believe I saw a proposal to have a crosswalk at Park Lane and Villa Rd. For elementary aged children, I am concerned that will be unsafe, especially if an entry / exit to the development are placed along Villa Rd just south of Park Lane.

- Having an entry / exit into this planned development off of Villa Rd. just south of Park Lane does not seem practical, as it will put this intersection and this driveway too close together increasing the possibility of side angle crashes.
- Finally, I want to be clear. For this proposed multi-family housing proposal specifically, I am concerned about the final item noted; the driveway to the development so close to Park Lane.
- All of the other concerns noted, are regardless of whether or not there are single family dwellings or multi-family dwellings placed on this property. This particular area; undeveloped Villa Rd and the certain increase in vehicle, bicycle and pedestrian traffic, especially if this increase included elementary aged school children and multi-family housing units, brings about special issues that must be considered and addressed prior to moving forward.

Respectfully submitted,

Chris Bolek
Newberg-Dundee Police Department

ATTACHMENT 3: AERIAL PHOTO



MARTELL COMMONS COMPREHENSIVE PLAN AMENDMENT AND ZONE CHANGE

DATE: April 7, 2015

SUBMITTED TO: City of Newberg Planning Department
Newberg City Hall
414 E. First Street
Newberg, OR 97132

APPLICANT: DJ2 Holdings, LLC
12042 SE Sunnyside Rd. Suite 590
Portland, OR 97015



12965 SW Herman Road, Suite 100
Tualatin, OR 97062
P: (503) 563-6151
F: (503) 563-6152
www.aks-eng.com

I. General Information	3
Request	3
Project Description.....	3
Site Description	3
Comprehensive Plan Map:.....	5
Zoning Map:	5
III. Applicable Review Criteria	6
Newberg Development Code.....	6
Chapter 15.100 LAND USE PROCESSES AND PROCEDURES	6
Article I. Procedure Types and Determination of Proper Procedures	6
Article II. Processing Type I – IV Development Actions	7
Article III. Appeals	7
Article IV. Notice	7
Chapter 15.302 DISTRICTS AND THEIR AMENDMENT	8
Chapter 15.305 ZONING USE TABLE	11
Chapter 15.405 LOT REQUIREMENTS	12
Newberg Comprehensive Plan.....	15
II. GOALS AND POLICIES	15
A. CITIZEN INVOLVEMENT	15
I. HOUSING.....	15
K. TRANSPORTATION	17
L. PUBLIC FACILITIES AND SERVICES	21
M. ENERGY	22
N. URBANIZATION	22
III. PLAN CLASSIFICATIONS	23
IV POPULATION GROWTH.....	23
A. HISTORIC POPULATION	23
B. POPULATION PROJECTIONS	24
V. LAND NEED AND SUPPLY	24
IV. Conclusion	28

EXHIBITS:

- Exhibit A: Conceptual Site Plan
- Exhibit B: County Tax Map and Trio
- Exhibit C: Application Form
- Exhibit D: Infrastructure Capacity Analysis
- Exhibit E: Neighborhood Meeting Documentation
- Exhibit F: Traffic Impact Analysis
- Exhibit G: Housing Needs Analysis

COMPREHENSIVE PLAN AMENDMENT AND ZONE CHANGE APPLICATION FOR MARTELL COMMONS

OWNER:	Martell Family Farms, LLC 23480 NE Hyland Drive Newberg, OR 97132
APPLICANT:	DJ2 Holdings, LLC 12042 SE Sunnyside Rd. Suite 590 Portland, OR 97015 Contact: Jeff Curran (jeff@dj2holdings.com)
LAND USE	AKS Engineering & Forestry, LLC 12965 SW Herman Road, Suite 100 Tualatin, OR 97062 (503) 563-6151 Contact: Mimi Doukas, AICP, RLA (mimid@aks-eng.com)
CIVIL ENGINEER:	3J Consulting, Inc 5075 Southwest Griffith Drive Suite 150 Beaverton, OR 97005 503-946-9365 Contact: John Howorth, PE
TRAFFIC ENGINEER:	Kittelson and Associates 610 SW Alder St, Suite 700 Portland, Oregon 97205 503.228.5230 phone Contact: Brian Dunn, PE
ECONOMIST:	Cogan Owens Greene 813 SW Alder Street, Suite 320 Portland, OR 97205-3111 Phone: 503-225-0192 Contact: Steve Faust, AICP
SITE LOCATION:	1317 Villa Road
ASSESSOR'S INFORMATION:	Tax Map 3217BC Taxlot 00800
SITE SIZE:	5.94 acres total (bifurcated lot)
EXISTING LAND USE/ZONE:	Low Density Residential (LDR) / R-1
PROPOSED LAND USE/ZONE:	High Density Residential (HDR) / R-3

I. GENERAL INFORMATION

REQUEST

DJ2 Holdings, LLC is requesting approval of a Type III Comprehensive Plan Amendment and Zone Change from Low Density Residential/R-1 to High Density Residential/R-3 for 5.94 acres on Taxlot 3217BC 00800 (the property is bifurcated by the railroad tracks; the parent parcel contains 5.91 acres). This written narrative, together with preliminary plans and other documentation included in the application materials, establishes that the application is in compliance with all applicable approval criteria. This documentation represents substantial evidence and provides the basis for the Planning Commission and City Council to approve the application.

PROJECT DESCRIPTION

Ultimately, DJ2 Holdings, LLC plans to build an apartment complex on the Martell Commons property. A concept sketch has been included in Exhibit A, although this application is only for the Comprehensive Plan Amendment and Zone Change at this time. If approved, the Applicant will then submit a Development Review application for the final site design.

The Applicant met with surrounding property owners in December 2014 to discuss the land use proposal. Similar concept sketches were shared, as well as example building elevations. Key areas of concern were traffic impacts, the number of units proposed, and adequate parking. Based on feedback from that meeting the Applicant has revised the conceptual plan to reduce the number of units, increase the number of parking spaces per dwelling unit, and reduced the number of buildings along the western property line.

From a land use perspective, Yamhill County projects a growth rate for Newberg of approximately three percent per year over the next 15 years. As shown in a Housing Needs Analysis prepared by Cogan Owens Green (Exhibit G), the land available for residential development within the Newberg Urban Growth Boundary is not sufficient to accommodate this expected growth. Newberg lacks enough land in the LDR, MDR, and HDR designations. Proportionately, Newberg only has current capacity to accommodate 89% of the projected LDR need, 34% of the projected MDR need, and only 13% of the projected HDR need.

Changing the Martell Commons property from LDR to MDR will allow for more efficient use of the limited land available within the Urban Growth Boundary, but will also provide more diverse housing opportunities particularly north of the railroad tracks. The only significant vacant R-3 land available is located at 108 Springbrook Road near Springbrook Oaks, and a small 1.3 acre parcel at 601 Blaine Street.

SITE DESCRIPTION

Martell Commons (TL 3217BC 00800) is located on the west side of Villa Road and north of the George Fox campus and railroad tracks, although the property is bifurcated by the railroad tracks creating a small remnant parcel south of the railroad tracks; there are no development plans for this tiny parcel. The parent parcel currently contains a small farm and house. This site has remained in farm production as the neighborhoods around it have developed to urban densities.

Land to the north has been developed into single family detached homes with primarily R-2 zoning and a small stretch of R-1 adjacent to Villa Road. East of Villa Road there are three homes that front onto Villa Road that are zoned R-1. South of those homes, Hess Creek flows under Villa Road and the railroad tracks. This corridor is zoned Industrial, but is not developable due to the creek. West of Martell Commons are existing single family detached homes in an R-1 zone. To the southwest, a row of duplex homes back up

to the railroad tracks with a zone of R-2. The site is bounded to the south by the railroad tracks and a trestle where the tracks cross over Villa Road. South of the railroad is the George Fox campus and associated sports fields.

The site slopes down from the northwest generally to the southeast, ultimately draining into Hess Creek. Slopes are generally four to five percent for most of the site, increasing to ten to twelve percent along the southern edge.

DESCRIPTION OF SURROUNDING AREA

Area	Jurisdiction	Zoning	Land Uses
North	Newberg	R-2/R-1	Single Family detached residential
South	Newberg	R-1	Railroad / Hess Creek / George Fox campus
East	Newberg	R-1/ I	Single-family detached residential / Hess Creek
West	Newberg	R-1/R-2	Single Family detached residential / duplex residential

PUBLIC UTILITIES

Service	Provider	Size	Location	Distance from site
Water	Newberg	8"	Villa Road	Adjacent (E)
Water	Newberg	8"	Park Road	Adjacent (N)
Sanitary Sewer	Newberg	8"	Park Road	Adjacent (N)
Sanitary Sewer	Newberg	8"	South Property Line	Adjacent (S)
Storm Sewer	Newberg	12"	Park Road	Adjacent (N)
Storm Sewer	Newberg	21"/24"	South Property Line	Adjacent (S)

TRANSPORTATION

Villa Road is classified as a major collector. The planned right-of-way width is 30 feet from centerline. Existing right-of-way is 20 feet from centerline so a ten foot dedication is expected. Park Street is classified as a local street with a planned full right-of-way width of 60 feet. The existing right-of-way is abutting the centerline, so 30 feet of dedication is expected.

COMPREHENSIVE PLAN MAP:

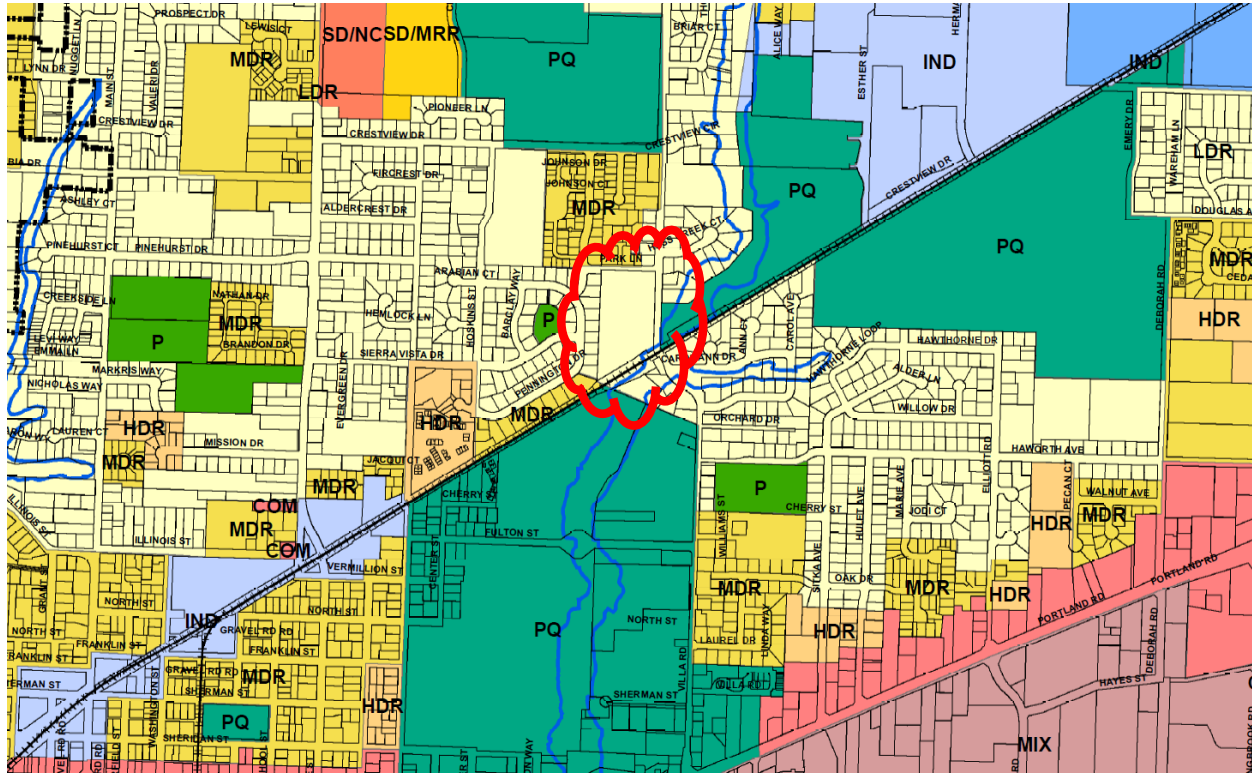

ZONING MAP:

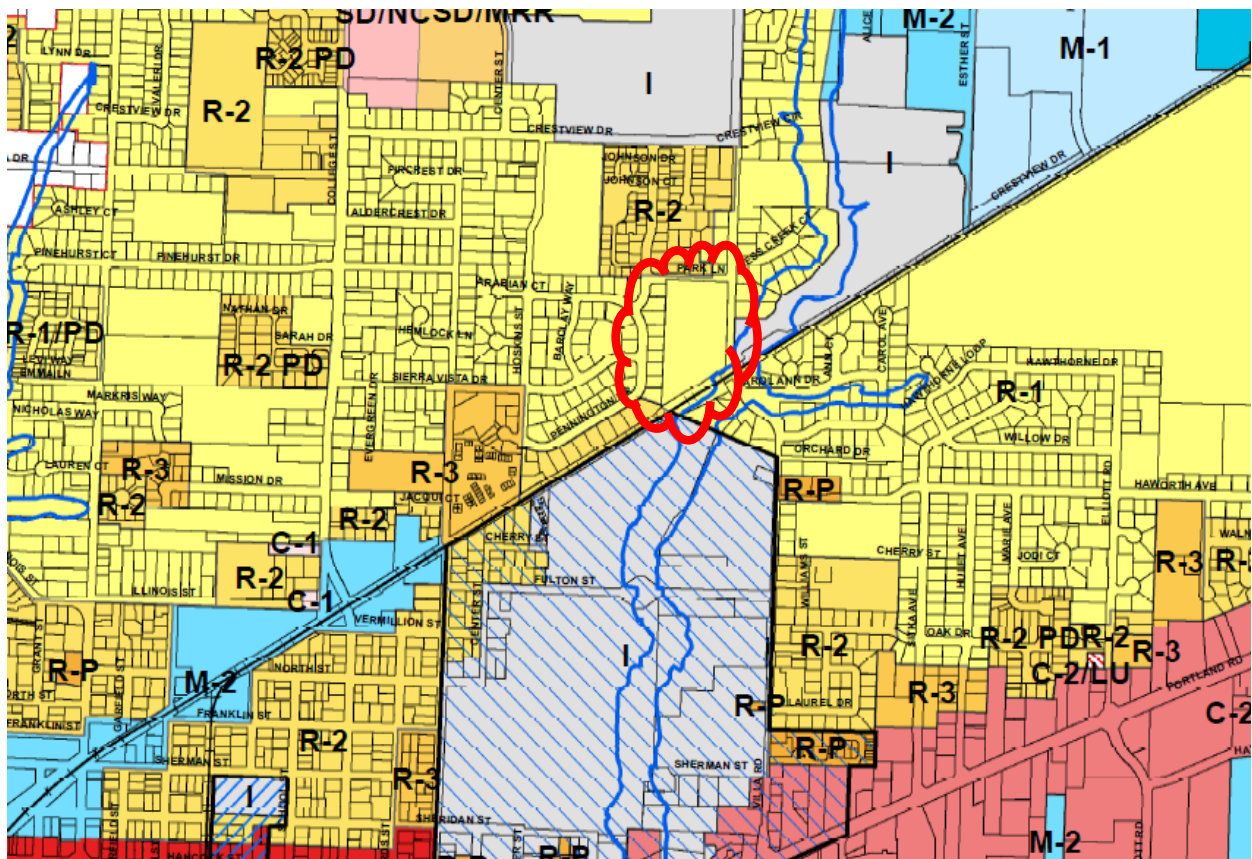

III. APPLICABLE REVIEW CRITERIA

NEWBERG DEVELOPMENT CODE

CHAPTER 15.100 LAND USE PROCESSES AND PROCEDURES

Article I. Procedure Types and Determination of Proper Procedures

- 15.100.010 Procedures for processing development permits.
- All development permits shall be classified as one of the following: Type I, Type II, Type III, or Type IV procedures.
- 15.100.050 Type III procedure – Quasi-judicial hearing.
- A. All Type III decisions shall be heard and decided by the planning commission. The planning commission’s decision shall be final unless the decision is appealed or the decision is a recommendation to the city council.
 - B. Type III actions include, but are not limited to:
 8. Comprehensive plan map amendments: this action is a recommendation to the city council.
 9. Zoning map amendments and designation of subdistricts: this action is a recommendation to the city council.
 - C. Planning Commission Decisions and Recommendation Actions.
 1. Planning Commission Decision. Development actions shall be decided by the planning commission for those land use actions that require a Type III procedure and do not require the adoption of an ordinance. The decision shall be made after public notice and a public hearing is held in accordance with the requirements of NMC 15.100.090 et seq. A Type III decision may be appealed to the city council by a Type III affected party in accordance with NMC 15.100.160 et seq.
 2. Planning Commission Recommendation to City Council. Land use actions that would require the adoption of an ordinance shall be referred to the city council by the planning commission together with the record and a recommendation. The recommendation shall be made after public notice and a public hearing is held in accordance with the requirements of NMC 15.100.090 et seq.
 - D. City Council Action. If a recommendation to the city council is required, the matter shall be reviewed by the city council as a new hearing. The final decision on these actions is made by the city council.
 - E. The applicant shall provide notice pursuant to NMC 15.100.200 et seq.
 - F. The hearing body may attach certain conditions necessary to ensure compliance with this code.
 - G. If the application is approved, the director shall issue a building permit when the applicant has complied with all of the conditions and other requirements of this code.
 - H. If a Type III application is denied, or if the applicant wishes to make substantive modifications to an approved application, the applicant may modify the application after the planning commission hearing and request a new planning commission hearing to consider the application. An application so modified shall be considered a new application for purposes of the 120-day

time limit for processing applications in accordance with NMC 15.100.100 and state statutes. The applicant shall acknowledge in writing that this is a new application for purposes of the 120-day rule. The city council shall establish a fee for such a reconsideration or modification by resolution. Application of this provision is limited to three times during a continuous calendar year.

Response: This application proposes a Comprehensive Plan Amendment and Zone Change. This will be reviewed as a Type III application reviewed by the Planning Commission with a recommendation to City Council for a final decision. The Applicant will provide notice of the hearings in compliance with the development code. This criterion will be met.

Article II. Processing Type I – IV Development Actions

15.100.150 Decision, findings and order – Types III and IV.

- A. Following the hearing for review of a development permit, the hearing body shall approve, conditionally approve, or deny the application. If the hearing is an appeal, the hearing body shall affirm, reverse, or remand the decision that is on appeal.
- B. The hearing body shall prepare written findings of fact and an order which shall include:
 1. A statement of the applicable criteria against which the proposal was tested.
 2. A statement of the facts that the hearing body found establishing compliance or noncompliance with each applicable criterion and assurance of compliance with applicable standards.
 3. The reasons for a conclusion to approve or deny.
 4. The decision to approve the proposed change with or without conditions, or the decision to deny the proposed change.
- C. The director shall notify the applicant and others entitled to notice of the disposition of the application within five calendar days of the written decision. This shall include the applicant, anyone providing written testimony prior to the close of the hearing, anyone providing oral testimony at the hearing, or anyone requesting such notice. The notice shall include a description of the item, indicate the date that the decision will take effect and describe the right of appeal pursuant to NMC 15.100.160 et seq.

Response: This Type III application will be reviewed by the Planning Commission with a recommendation to City Council for a final decision. The City Council will issue a final decision based on written findings of fact and notify all participants.

Article III. Appeals

15.100.160 Appeal procedures.

- C. Type III. An appeal of a Type III decision by the planning commission may be appealed within 14 calendar days of the date of the planning commission's written decision. Appeals may be made only by an affected party, Type III.

Article IV. Notice

15.100.200 Compliance required.

Notice on all Type I through Type IV actions, including appeals, shall be conducted in accordance with this article.

15.100.210 Mailed notice.

Mailed notice shall be provided as follows:...

- 15.100.230 Additional notice procedures for Type III quasi-judicial hearing.
In addition to the requirements of NMC 15.100.210, mailed notice for Type III development actions shall also contain the following:...
- 15.100.260 Procedure for posted notice for Type II and III procedures....
- 15.100.270 Procedure for published notice on Type III and Type IV procedures....

Response: The Applicant will work with City Staff to provide all required notice for this Type III application. This criterion will be met.

CHAPTER 15.302 DISTRICTS AND THEIR AMENDMENT

15.302.030 Procedures for comprehensive plan map and zoning map amendments.
This section describes the procedures and criteria that apply to any application to amend the land use designations identified on the comprehensive plan map, zoning map and land use regulations.

- A. Type III Plan and Zoning Map Amendments – One Parcel or Small Group of Parcels.
1. Property owners or the city may initiate a map amendment for one parcel or a small group of parcels under the Type III procedure. May be initiated by a resolution of the planning commission or city council. Unlike other Type III procedures, the decision of the planning commission on a Type III plan map amendment shall be in the form of a recommendation to the city council. The city council shall hold another new hearing and make a final decision.

Response: The Applicant, DJ2 Holdings LLC, proposes a Comprehensive Plan Amendment and Zone Change for one parcel, Taxlot 3217BC 00800. This will be reviewed as a Type III application reviewed by the Planning Commission with a recommendation to City Council for a final decision.

2. Where an application has been denied, no new application for the same purpose shall be filed within one year of the date of the previous denial unless the city council for good cause shall grant permission to do so.
3. Amendment Criteria. The owner must demonstrate compliance with the following criteria:
 - a. The proposed change is consistent with and promotes the goals and policies of the Newberg comprehensive plan and this code;

Response: The goals and policies of the Comprehensive Plan are addressed in detail later in this narrative. Overall, the proposed Plan and Zoning Map amendments promote the efficient use of limited land within the Urban Growth Boundary, improve housing diversity in this area of Newberg, provide affordable multi-family housing close to employment and urban services, and located along a major collector. These all match the goals and policies outlined in the Comprehensive Plan.

- b. Public facilities and services are or can be reasonably made available to support the uses allowed by the proposed change;

Response: Exhibit D includes an Infrastructure Analysis for the proposed Comprehensive Plan Amendment and Zone Change. This memo reviews the existing infrastructure for domestic water, sanitary sewer, and storm drainage. It then reviews the impact that the potential 147 dwelling units will have on the existing infrastructure, and identifies any mitigation necessary to accommodate this additional impact. In addition, the memo outlines the expected transportation improvements necessary for development based upon City Standards, the Transportation System Plan, and recommendations from the Traffic Impact Analysis in Exhibit F. In summary, the water, sewer, and storm drainage facilities have sufficient capacity to accommodate development of Martell Commons. Expected transportation improvements include half street widening for Villa Road including the addition of a bike lane and sidewalks, widening Park Lane to provide a curb to curb width of 32 feet including a dedicated left turn lane and sidewalk along the project frontage.

- c. **Compliance with the State Transportation Planning Rule (OAR 660-012-0060) for proposals that significantly affect transportation facilities.**

Response: A full Transportation Impact Analysis is provided in Exhibit F; this report specifically addresses the Transportation Planning Rule OAR 660-12-0060. The proposed zone change does not require or result in any changes to the functional classification of any transportation facility in the vicinity of the site or to the standards that implement the functional classification system. The Villa Road/Fulton Street and Villa Road/OR 99W intersections are already forecast to miss performance standards under 2035 background conditions, even without the proposed rezone. Mitigation for the Villa/Fulton intersection include installation of an all-way stop control. This improvement will enhance intersection operations from LOS "F" to LOS "E" during the 2035 weekday p.m. peak hour. This represents an improvement to level of service than under 2035 background traffic conditions.

Action 1F.5 of the Oregon Highway Plan states that small increases in traffic, up to 400 ADT, do not cause "further degradation" of state highway facilities. Although the proposed zone change could generate an additional 795 daily trips over current zoning potential, less than 400 of these trips are anticipated to reach the Villa Road/OR 99W intersection.

Finally, Action 1F.5 allows for capacity increasing improvements that include system connectivity improvements (for vehicles, bicycles and pedestrians) and multi-modal opportunities to reduce vehicle demand. The pedestrian and bicycle improvements proposed with the development along Villa Road and the completion of a continuous pedestrian route from the rezone site to George Fox University will sufficiently mitigate the small increase in v/c ratio forecast the Villa Road/OR 99W intersection.

4. **The property owner who desired to have their property reclassified has the burden of establishing that the requested classification meets the requirements of this section. As part of the application, the property owner requesting a change shall file a waiver stating that the owner will not file any demand against the city under Ballot Measure 49, approved November 6, 2007, that amended ORS Chapters 195 and 197.**

Response: The amendment criteria have been addressed above and throughout this narrative. The property owner will sign a waiver on City forms.

5. A traffic study shall be submitted for any proposed change that would significantly affect a transportation facility, or that would allow uses that would increase trip generation in excess of 40 trips per p.m. peak hour. This requirement may be waived by the director when a determination is made that a previous traffic study adequately addresses the proposal and/or when off-site and frontage improvements have already been completed, which adequately mitigate any traffic impacts and/or the proposed use is not in a location, which is adjacent to an intersection, which is functioning at a poor level of service. A traffic study may be required by the director for changes in areas below 40 trips per p.m. peak hour where the use is located immediately adjacent to an intersection functioning at a poor level of service. The traffic study shall be conducted according to the City of Newberg design standards.

Response: A full Traffic Impact Analysis has been included in Exhibit F. This report studied both the impact of the proposed zone change on the 2035 performance of the planned transportation system, as well as the short term build out impacts of the proposed apartment complex on the existing roadway system, and listed necessary mitigation measures to ensure there is not a significant degradation of the Newberg transportation system.

15.302.032 Purposes of each zoning district.

A. R-1 Low Density Residential District.

1. The purpose of this land use designation is to provide for low density urban single-family residential uses at an average overall density of 4.4 units per gross buildable acre in the district. It is intended to provide a stable and healthful environment together with the full range of urban services.
2. Typical housing types will include single-family dwellings and planned unit developments. The district also is intended to allow low intensity institutional uses that operate consistent with peaceful enjoyment of residential neighborhoods. The R-1 district is intended to be consistent with the low density residential (LDR) designation of the comprehensive plan.

C. R-3 High Density Residential District.

1. The purpose of this land use designation is to provide multifamily dwellings of different types and styles at an average overall density of 16.5 units per gross buildable acre in the district.
2. Typical housing types will include duplexes, multifamily dwellings, and manufactured dwelling and mobile home parks. The district also is intended to allow low intensity institutional uses that operate consistent with peaceful enjoyment of residential neighborhoods. Density may vary depending on lot size, off-street parking area, transportation, landscaping and other site considerations. The R-3 district is intended to be consistent with the high density residential (HDR) designation of the comprehensive plan.

Response: If this application is approved, DJ2 Holdings will submit for Site Plan Review for an apartment complex based on the Concept Sketch in Exhibit A. The land use review will

consider parking, intensity, landscaping, buffering, and transportation impacts. The Concept Plan has been revised based on neighborhood feedback to reduce the number of dwelling units, increase the number of parking spaces per dwelling unit, and reduce the number of structures adjacent to existing homes along the western property line.

An R-3 designation is appropriate in this location due to several factors. The size of the property allows for thoughtful site planning, with two story structures along the western boundary, and significant separation from the western property line for buffering. The location is within walking and biking distance to George Fox University. Joan Austin Elementary School is within a half mile, A-dec is within three fourths of a mile, and within a quarter mile of the Chehalem Aquatic & Fitness Center, and within three fourths of a mile of Highway 99W. It is located along a major collector street, Villa Road. Villa is planned for bike lanes for convenient alternative connections to community services listed above, including education, employment, services, and recreation.

CHAPTER 15.305 ZONING USE TABLE

15.305.010 Classification of uses.

The zoning use table under NMC 15.305.020 identifies the land uses that are allowed in the various zoning districts. The specific land use categories are described in Chapter 15.303 NMC. The table identifies each use as one of the following:

- P** Permitted Use. The use is a permitted use within the zone. Note that the use still may require design review, building permits, or other approval in order to operate.
- C** Conditional Use. A conditional use permit is required for the use. See Chapter 15.225 NMC.
- S** Special Use. The use is subject to specific standards as identified within this code. The applicable section is included in the last column of the table.
- (#)** A note indicates specific limits on the use. These notes are listed at the bottom of the table.
- X** Prohibited Use. The use is specifically prohibited.

If none of the codes above are indicated, then the use is not permitted within the zone.

#	Use	R-1	R-3	Notes and Special Use Standards
200	RESIDENTIAL USES			
Def.	Dwelling, single-family detached	P(2)	P(3)	Subject to density limits of NMC 15.405.010(B)
Def.	Dwelling, single-family attached	S(2)	S(3)	NMC 15.415.050 ; subject to density limits of NMC 15.405.010(B)
Def.	Manufactured home on individual lot	S(2)	S(3)	NMC 15.445.050 – 15.445.070 ; subject to density limits of NMC 15.405.010(B)
Def.	Manufactured dwelling park		S	NMC 15.445.075 – 15.445.160
Def.	Mobile home park		S	NMC 15.445.075 – 15.445.160
Def.	Manufactured home subdivision			NMC 15.445.075 – 15.445.160
Def.	Dwelling, two-family (duplex)	P(2)	P	Subject to density limits of NMC 15.405.010(B)

Def.	Dwelling, multifamily	C	P	Subject to density limits of NMC 15.405.010(B)
Def.	Dwelling, accessory	C	S	Chapter 15.445 NMC, Article V
Def.	Dwelling, mixed use			
Def.	Dwelling, caretaker			Limited to one per lot , and allowed whenever the use requires the on-site residence of such person .
Def.	Dormitory		P	
Def.	Home occupation (no more than one outside paid employee)	S	S(13)	NMC 15.415.060
Def.	Home occupation (more than one outside paid employee)	C	C(13)	NMC 15.415.060

Key:

P: Permitted use

S: Special use – Use requires a special use permit

C: Conditional use – Requires a conditional use permit

X: Prohibited use

(#): See notes for limitations

Notes....

- (2) Limited to one per lot as a permitted use. More than one per lot allowed only through a conditional use permit or planned unit development, subject to density limits of NMC 15.405.010(B).
- (3) Permitted on individual lots created prior to November 17, 1992. Homes on individual lots created on or after November 17, 1992, will only be permitted through the planned unit development process.
- (13) Permitted in existing dwelling units only. New dwelling units may not be created for this use unless the dwelling unit would otherwise be allowed.

Response: As previously described, the Applicant’s goal is to build a multi-family apartment complex. This is a permitted use within the R-3 zone.

CHAPTER 15.405 LOT REQUIREMENTS

15.405.010 Lot area – Lot areas per dwelling unit.

- A. In the following districts, each lot or development site shall have an area as shown below except as otherwise permitted by this code:
 - 1. In the R-1 district, each lot or development site shall have a minimum area of 5,000 square feet or as may be established by a subdistrict. The average size of lots in a subdivision intended for single-family development shall not exceed 10,000 square feet.
 - 2. In the R-2, R-3, and RP districts, each lot or development site shall have a minimum area of 3,000 square feet or as may be established by a subdistrict. In the R-2 and R-P districts, the average size of lots in a subdivision intended for single-family development shall not exceed 5,000 square feet.

Response: The Martell Commons site contains 5.94 acres, well above the minimum lot size of 3,000 square feet of this section. This criterion is met.

B. Lot or Development Site Area per Dwelling Unit.

- 1. In the R-1 district, there shall be a minimum of 5,000 square feet per dwelling unit.
- 2. In the R-2, AR, and R-P districts, there shall be a minimum of 3,000 square feet of lot or development site area per dwelling unit. In the

R-2 and R-P districts, lots or development sites in excess of 15,000 square feet used for multiple single-family, duplex or multifamily dwellings shall be developed at a minimum of one dwelling per 5,000 square feet lot area.

3. In the R-3 district, there shall be a minimum of 1,500 square feet of lot or development site area per dwelling unit. Lots or development sites in excess of 15,000 square feet used for multiple single-family, duplex or multifamily dwellings shall be developed at a minimum of one dwelling per 2,500 square feet lot area.

Response: The site contains 5.94 acres, or 258,746 square feet. Assuming that the net site area after right-of-way dedications will be approximately 85% of the gross area, there would be an approximate net site area of 219,934 square feet. This would allow an approximate maximum density of 147 dwelling units and a minimum of 88 dwelling units. The actual site density will depend on final site design and will be limited by a balance with available parking but is expected to be close to 128 units as described in the Transportation Analysis.

- C. In calculating lot area for this section, lot area does not include land within public or private streets. In calculating lot area for maximum lot area/minimum density requirements, lot area does not include land within stream corridors, land reserved for public parks or open spaces, commons buildings, land for preservation of natural, scenic, or historic resources, land on slopes exceeding 15 percent or for avoidance of identified natural hazards, land in shared access easements, public walkways, or entirely used for utilities, land held in reserve in accordance with a future development plan, or land for uses not appurtenant to the residence.
- D. Lot size averaging is allowed for any subdivision. Some lots may be under the minimum lot size required in the zone where the subdivision is located, as long as the average size of all lots is at least the minimum lot size.

Response: Final net site area calculations will be provided for Site Design Review once a final design is proposed.

15.405.030 Lot dimensions and frontage.

- A. Width. Widths of lots shall conform to the standards of this code.
- B. Depth to Width Ratio. Each lot and parcel shall have an average depth between the front and rear lines of not more than two and one-half times the average width between the side lines. Depths of lots shall conform to the standards of this code. Development of lots under 15,000 square feet are exempt from the lot depth to width ratio requirement.
- C. Area. Lot sizes shall conform to standards set forth in this code. Lot area calculations shall not include area contained in public or private streets as defined by this code.
- D. Frontage.
 1. No lot or development site shall have less than the following lot frontage standards:
 - a. Each lot or development site shall have either frontage on a public street for a distance of at least 25 feet or have access to a public street through an easement that is at least 25 feet wide. No new private streets, as defined in NMC 15.05.030, shall be created to provide frontage or access.

- b. Each lot in an R-2 and R-3 zone shall have a minimum width of 30 feet at the front building line.
 - c. Each lot in an R-1, AI, or RP zone shall have a minimum width of 50 feet at the front building line.
 - d. Each lot in an AR zone shall have a minimum width of 45 feet at the front building line.
2. The above standards apply with the following exceptions:
 - a. Legally created lots of record in existence prior to the effective date of the ordinance codified in this code.
 - b. Lots or development sites which, as a process of their creation, were approved with sub-standard widths in accordance with provisions of this code.
 - c. Existing private streets may not be used for new dwelling units, except private streets that were created prior to March 1, 1999, including paving to fire access roads standards and installation of necessary utilities, and private streets allowed in the airport residential and airport industrial districts.

Response: The Martell Commons site has a width of approximately 384 feet which exceeds the minimum of 30 feet for the proposed R-3 zone. This criterion is met.

15.405.040 Lot coverage and parking coverage requirements.

- A. Purpose. The lot coverage and parking coverage requirements below are intended to:
 1. Limit the amount of impervious surface and storm drain runoff on residential lots.
 2. Provide open space and recreational space on the same lot for occupants of that lot.
 3. Limit the bulk of residential development to that appropriate in the applicable zone.
- B. Residential uses in residential zones shall meet the following maximum lot coverage and parking coverage standards. See the definitions in NMC 15.05.030 and Appendix A, Figure 4.
 1. Maximum Lot Coverage.
 - a. R-1: 30 percent, or 40 percent if all structures on the lot are one-story.
 - b. R-2 and RP: 50 percent.
 - c. AR and R-3: 50 percent.
 2. Maximum Parking Coverage. R-1, R-2, R-3, and RP: 30 percent.
 3. Combined Maximum Lot and Parking Coverage.
 - a. R-1, R-2 and RP: 60 percent.
 - b. R-3: 70 percent.

Response: Final lot coverage and parking coverage calculations will be provided for Site Design Review once a final design is proposed.

NEWBERG COMPREHENSIVE PLAN

II. GOALS AND POLICIES

The following goals and policies are important elements in the Comprehensive Plan. These statements indicate the intent of the Plan and establish directions for future planning decisions and activities.

A. CITIZEN INVOLVEMENT

GOAL: To maintain a Citizen Involvement Program that offers citizens the opportunity for involvement in all phases of the planning process.

Response: A voluntary neighborhood meeting was held on December 16, 2014 at the Newberg Christian Church. Notice was sent to all property owners within 500 feet of the property. The meeting was very well attended. As noted previously, the primary concerns appeared to be transportation impacts, number of dwelling units, sufficient parking, and architectural design. The Applicant has already modified the conceptual plan to reduce the proposed number of units, increase the parking ratio, reduce the number of buildings along the western boundary, and change the color palette of the structures to earth tones. The public will also have the opportunity to participate in the Planning Commission hearing as well as the City Council hearing. Public notice will be provided for each of those hearings as well as a notice of decision for all who participate.

I. HOUSING

GOAL: To provide for diversity in the type, density and location of housing within the City to ensure there is an adequate supply of affordable housing units to meet the needs of City residents of various income levels.

POLICIES:

2. Location Policies

- a. Medium and high density areas should be located for immediate access to collector streets or minor arterials and should not cause traffic to move through low density areas. High density areas should be easily accessible to arterial streets. They should also be located near commercial services and public open spaces.

Response: As noted before, an R-3 designation is appropriate in this location due to several factors. The size of the property allows for thoughtful site planning, with two story structures along the western boundary, and significant separation from the western property line for buffering. The location is within walking and biking distance to George Fox University. Joan Austin Elementary school is within a half mile, A-Dec is within three fourths of a mile, and within a quarter mile of the Chehalem Aquatic & Fitness Center, and within three fourths of a mile of Highway 99W. It is located along a major collector street, Villa Road. Villa is planned for bike lanes for convenient alternative connections to community services listed above, including education, employment, services, and recreation.

3. Mix Policies

AFFORDABLE HOUSING means a dwelling unit that provides housing for a family or individual(s) with a household income less than the median household income for the Newberg area, such that a household pays no more than 30 percent of its annual income on housing (rent/mortgage, utilities, property taxes). Affordable housing may include a care home for low-income individuals.

Affordability can be assured through deed-restriction or other recorded documents that specify qualifying income of buyers or renters, and limiting sales price, rent levels and appreciation. Affordable housing may also include small, market-rate dwelling units (e.g., studios, apartments and accessory dwelling units).

Response: Martell Commons will not be an Affordable Housing project as defined by this Plan policy, but it will provide an affordable housing option for many residents of Newberg located close to employment, services, and educational uses. The proposed units will be a combination of one, two, and three bedroom units with efficient internal layouts that allows for a lower overall rental rate. With the close proximity of George Fox University, students are an identified tenant profile that is sensitive to rental rates.

- b. Low and moderate income housing should not be concentrated within particular areas of the City.

Response: This area of Newberg does not contain a large concentration of low and moderate income housing. There is a new Affordable Housing project called Deskin Commons to the west on Meridian Street just north of the railroad tracks. Most other R-3/apartment lands (moderate income housing) are located south of the railroad tracks. Approval of this amendment would provide family wage housing opportunities close to the A-Dec employment area as well as near George Fox University.

- k. The City shall encourage an adequate supply of rental housing dispersed throughout the City to meet the needs of renters.

Response: Again, this area of Newberg does not contain a large concentration of low and moderate income housing. There is a new Affordable Housing project called Deskin Commons to the west on Meridian Street just north of the railroad tracks. Most other R-3/apartment lands are located south of the railroad tracks. Approval of this amendment would provide family wage housing opportunities close to the A-Dec employment area as well as near George Fox University.

- o. The City has adopted a comprehensive approach to meeting local housing needs that balances density, design, and flexibility in code standards and procedures. The City shall use development incentives such as density bonuses, flexible development standards, and streamlined review procedures to stimulate or require the production and preservation of affordable housing. (replaces old policy “o”)

Response: No density bonuses are requested. The proposed Plan Amendment and Zone Change will allow for development of an apartment complex. The proposed density is within the typical range for an apartment complex and matches the density of the R-3 zone.

- u. The City shall build understanding and support for affordable housing through educational forums with residents and employers, pre-application consultations with developers, and through local housing studies.
- v. The City shall work with local affordable housing providers in developing an overall strategy for meeting Newberg’s housing needs.
- w. City resources shall be directed toward assisting public and private entities in producing and preserving affordable housing throughout the community.

- z. To the extent possible, the City shall zone residential housing near employment centers.

Response: The Comprehensive Plan contains many goals and policies in support of affordable housing within Newberg. As noted above, this project will not meet the Plan's definition of affordable housing with specific rent and income limits, it will provide an affordable housing opportunity for the residents of Newberg. This property will also improve the diversity of housing opportunities near the A-dec employment district.

K. TRANSPORTATION

GOAL 3: Promote reliance on multiple modes of transportation and reduce reliance on the automobile.

POLICIES:

- b. Modifications should be made to the City's land use plan and development ordinances that will decrease trip length and encourage non-auto oriented development.
- 2) The City shall encourage higher density development in residential areas near transit corridors, commercial areas and employment centers, including the downtown.

Response: This proposed R-3 site is within walking and biking distance to George Fox University. Joan Austin Elementary school is within a half mile, A-Dec is within three fourths of a mile, and within a quarter mile of the Chehalem Aquatic & Fitness Center, and within three fourths of a mile of Highway 99W. It is located along a major collector street, Villa Road. Villa is planned for bike lanes for convenient alternative connections to community services listed above, including education, employment, services, and recreation.

GOAL 4: Minimize the impact of regional traffic on the local transportation system.

POLICIES:

- k. For the purposes of compliance with the Transportation Planning Rule, OAR 660-12-0060 and in order to support the goal exception that Yamhill County took to advance construction of the Bypass, the City of Newberg acknowledges that reliance upon the Bypass as a planned improvement to support comprehensive plan amendments or zone changes is premature.

In accordance with OAR 660-012-0060, the Bypass will be considered a planned improvement that is reasonably likely to be constructed during the 20-year planning horizon when the OTP includes all or a specific phase of the Bypass in the construction section of the Statewide Transportation Improvement Program (STIP), or when ODOT provides a written statement that the improvements are reasonably likely to be provided by the end of the planning period. ODOT expects to provide such a letter upon receiving a record of decision for the design level EIS if it results in a record of decision authorizing a full Bypass or a specific Bypass phase that can be funded within the 20-year planning horizon. During the period before the Bypass can be considered a planned improvement, the City of Newberg will work with ODOT to pursue interim measures to comply with OAR 660-12-0060. This may include adopting alternative mobility standards for Oregon 99W and Oregon 219. For purposes of the Newberg TSP, alternative mobility standards are consistent with the planned function of Oregon 99W through Newberg as a lower speed local arterial intended to provide access to businesses and

residences and a more pedestrian friendly environment. Alternative mobility standards may continue to be necessary on Oregon 99W and Oregon 219 until the full Bypass can be completed.

Response: A full Transportation Impact Analysis is provided in Exhibit F; this report specifically addresses the Transportation Planning Rule OAR 660-12-0060. The proposed zone change does not require or result in any changes to the functional classification of any transportation facility in the vicinity of the site or to the standards that implement the functional classification system. The Villa Road/Fulton Street and Villa Road/OR 99W intersections are already forecast to miss performance standards under 2035 background conditions, even without the proposed rezone. Mitigation for the Villa/Fulton intersection include installation of an all-way stop control. This improvement will enhance intersection operations from LOS “F” to LOS “E” during the 2035 weekday p.m. peak hour. This represents an improvement to level of service than under 2035 background traffic conditions.

Action 1F.5 of the Oregon Highway Plan states that small increases in traffic, up to 400 ADT, do not cause “further degradation” of state highway facilities. Although the proposed zone change could generate an additional 795 daily trips over current zoning potential, less than 400 of these trips are anticipated to reach the Villa Road/OR 99W intersection.

Finally, Action 1F.5 allows for capacity increasing improvements that include system connectivity improvements (for vehicles, bicycles and pedestrians) and multi-modal opportunities to reduce vehicle demand. The pedestrian and bicycle improvements proposed with the development along Villa Road and the completion of a continuous pedestrian route from the rezone site to George Fox University will sufficiently mitigate the small increase in v/c ratio forecast the Villa Road/OR 99W intersection.

GOAL 5: Maximize pedestrian, bicycle and other non-motorized travel throughout the City.

POLICIES:

- a. The City shall provide safe, convenient and well-maintained bicycle and pedestrian transportation systems that connect neighborhoods with identified community destinations, such as schools, parks, neighborhood commercial centers, and employment centers.
- b. Bicycle parking facilities shall be required for all new and improved commercial, institutional, office, industrial, and multi-family development.
- c. All new and improved commercial, office, institutional, and multi-family development shall be conveniently and directly accessible from the public right-of-way by bicycle and on foot.
- d. Public sidewalks shall be provided along all public street frontages. Pedestrian traffic shall be separated from automobile traffic whenever possible.
 - (1) Sidewalks should be provided whenever there is development of abutting properties.
 - (2) Sidewalks should be constructed when any new road is constructed

(3) When existing roads are widened or improved, sidewalks should be provided.

- h. On-street bike lanes or parallel bikeways will be provided on all designated major collector and arterial roadways, and on certain neighborhood collectors if warranted from a bicycle system connectivity standpoint.

Response: A significant appeal of this site for multi-family development is the location along Villa Road. Villa is planned for bike lanes to provide for convenient alternative connections to community services including education, employment, services, and recreation. Development of the site will require frontage improvements along Villa to improve the bicycle and pedestrian corridor. On-site bicycle parking will also be required as well as a complete interior sidewalk system that connects to both Villa Road and Park Lane. It is an important business investment to complete the pedestrian and bicycle connection to the George Fox campus to attract student tenants.

GOAL 7: Minimize the capital improvement and community costs to implement the transportation plan.

POLICIES:

- a. The Transportation System Plan shall identify short and long term improvements to the collector/arterial street system, the public transit system, the pedestrian/bicycle system and the air, rail, water, and pipeline systems.
- b. The list of improvement projects in the Transportation System Plan shall guide development of the city's capital improvement plan for transportation projects.

Response: The Villa Road corridor is on the City's Capital Improvement Plan to adjust the engineering design to improve the vertical alignment and complete the multi-modal improvements. Upon development of Martell Commons, the project will be required to make frontage improvements to both Villa Road and Park Lane to match City standards. In addition, the project is responsible for System Development Charges (SDC's) based on the number of proposed dwelling units. The Applicant has been in discussions with the City Engineer about expanding the physical improvements along Villa Road in exchange for SDC credits. This is a best case scenario of maximizing the available financing for immediate improvements directly associated with the project. This coordination will continue as the project moves through the public review process.

- i. New development and existing development undergoing expansion or modification shall be designed to accommodate planned long-term transportation improvement projects in the vicinity of the development.

Response: As described below, development of the Martell Commons site will require frontage improvements to Villa Road and Park Lane to match City standards.

GOAL 8: Maintain and enhance the City's image, character and quality of life.

POLICIES:

- d. The City will encourage development that protects the integrity of existing neighborhoods, commercial, and industrial areas using the following design techniques.
 - 1) New development and new transportation facilities shall be designed to meet the street classification, design, and access standards identified in the Transportation System Plan.

Response: As described below, Villa Road is classified as a Major Collector. A half street right-of-way dedication of 30 feet will be required with development, as well as a half street widening of 34 feet to curb with a five foot bike lane, a six foot planter strip, and a six foot detached sidewalk. No on-street parking is permitted.

GOAL 9: Create effective circulation and access for the local transportation system.

POLICIES:

- c. Develop a system of roads that provide for efficient movement of traffic, considering the general design guidelines below:
 - 4) Major Collectors. Major collectors serve multi-neighborhood areas. They are intended to channel traffic from local streets and/or minor collectors to the arterial street system. A major collector can also provide access to abutting properties.
 - 60 to 80 feet of right-of-way with ten foot public utility easements.
 - 34 to 46 feet curb to curb cross section.
 - Five-foot bike lanes on both sides of the street.
 - On-street parking is generally not allowed except in the downtown and other areas where special circumstances warrant. No parking will be allowed within 20 feet of curb return.
 - A minimum six-foot planter strip and six-foot sidewalk on both sides of the street.

Response: Villa Road is classified as a Major Collector. A half street right-of-way dedication of 30 feet will be required with development, as well as a half street widening of 34 feet to curb with a five foot bike lane, a six foot planter strip, and a six foot detached sidewalk. No on-street parking is permitted.

- 6) Local Streets. Local streets provide direct access to adjoining properties and connect to collector streets. The system design criteria for local streets include:
 - 54-65 feet of right-of-way with 10 foot public utility easements.
 - For standard residential streets, standard 32 feet curb to curb with parking on both sides.
 - A minimum four and one half foot wide planting strip and five foot wide sidewalk on both sides of the street.
 - Where approved, limited residential streets may have narrower dimensions

Response: Park Lane is classified as a Local Street, but the partial improvements do not meet City standards. A right-of-way dedication of 30 feet will be required with development, as well as a street widening for a total width of 40 feet to allow for an additional northbound left turn lane, a five foot planter strip, and a five foot detached sidewalk. On-street parking will be permitted on both sides.

L. PUBLIC FACILITIES AND SERVICES

GOAL: To plan and develop a timely, orderly and efficient arrangement of public facilities and services to serve as a framework for urban development.

POLICIES:

1. All Facilities & Services Policies

- a. The provision of public facilities and services shall be used as tools to implement the land use plan and encourage an orderly and efficient development pattern.
- b. The extension of publicly-owned facilities and services into currently undeveloped areas shall occur only in accordance with the Public Facilities and Service Plan.
- c. New public facilities and services shall be designed at levels consistent with planned densities and designated land uses for the area.
- d. Services shall be planned to meet anticipated community needs.
- e. Owners of properties which are located on unimproved streets should be encouraged to develop their streets to City standards.
- f. Maximum efficiency for existing urban facilities and services will be encouraged through infill of vacant City land.
- h. New residential areas shall have: paved streets, curbs, pedestrian ways, water, sewer, storm drainage, street lights and underground utilities.

2. Sewers and Water Policies

- a. All existing development within the City limits will connect to public sewer and water systems as soon as they become available.
- b. Water systems within the planning area will be designed to provide an adequate peak flow for fire protection.
- c. Developments with urban densities should be encouraged to locate within the area which can be serviced by Newberg's present sanitary sewer system.

Response: An analysis of the infrastructure capacity for this proposed Comprehensive Plan Amendment is included in Exhibit D. The Newberg Water Master Plan shows that all property under an elevation of 300 feet can be served by the existing reservoir system. This property is at an elevation of 198 at the highest point, and can be served by public water. Eight inch waterlines are existing adjacent to the property within Villa Road and in Park Lane.

Storm drainage can be treated on site in a water quality facility and released into Hess Creek which abuts the property along the southern boundary.

Sanitary sewer is also immediately adjacent to the Martell site; there is an existing eight inch line along the southern boundary of the property and there is a second eight inch line in Park Lane. The Newberg Sanitary Sewer Master Plan shows that this area is over capacity. The Hess Creek trunk line has high levels of infiltration that have created capacity concerns. The City is currently working on an update of the infiltration rates in this corridor; the study is expected to be completed in April. This study may show that the infiltration rates are different than the adopted master plan, which will affect how much capacity is available for the Martell Commons site. If the study shows that there is still insufficient capacity, the Site Plan Review application may be conditioned to upsize existing downstream sanitary sewer pipes, or seal existing manholes and pipes to reduce infiltration rates. This will be studied in detail during Site Plan review after the City's capacity update is completed. No development will be approved without sufficient capacity and improvements can be reasonably conditioned on land use decisions.

Development of infill sites supports the policy of efficient use of existing infrastructure. The proposed Plan Amendment maximizes the efficiency of the public investment in water and sanitary sewer systems.

M. ENERGY

GOAL: To conserve energy through efficient land use patterns and energy-related policies and ordinances.

POLICIES:

1. Planning Policies

- a. The City will encourage energy-efficient development patterns. Such patterns shall include the mixture of compatible land uses and a compactness of urban development.

Response: As noted above, Development of infill sites supports the policy of efficient use of existing infrastructure. The proposed Plan Amendment maximizes the efficiency of the public investment in water and sanitary sewer systems.

N. URBANIZATION

GOALS:

1. To provide for the orderly and efficient transition from rural to urban land uses.
2. To maintain Newberg's identity as a community which is separate from the Portland Metropolitan area.
3. To create a quality living environment through a balanced growth of urban and cultural activities.

POLICIES:

3. General Policies

- a. In new development areas all utility lines shall be placed underground. In existing areas an effort will be made to locate power, telephone, cable television and other utility cables underground over a period of time.

Response: All proposed infrastructure will be placed underground. Existing overhead wires along Villa Road will be undergrounded with development of the site.

III. PLAN CLASSIFICATIONS

For the purpose of evaluating and eventually implementing the proposed Comprehensive Plan, descriptions of land use classifications are essential. Explanations of the map designations are as follows:

2. Residential Land Use

Residential land is divided into three categories. Density rather than housing type is generally the most important development criteria used to classify residential areas. Manufactured dwelling parks, mobile home parks and manufactured home subdivisions are permitted outright in the medium density residential zone. Manufactured homes on individual single family lots are permitted.

The following is a summary of the three residential land use categories:

a. Low Density Residential (LDR)

The objective of this designation is to provide a wide range of housing types and styles, while allowing for an overall density of up to 4.4 units per acre.

Typical housing types will include single-family attached and detached housing. Clustered housing areas within Planned Unit Developments or condominiums must include adequate open areas to maintain the low overall density of this classification.

Services shall include improved streets, underground utilities (except electrical transmission lines), street lighting, sidewalks, and in some cases, bikeways.

c. High Density Residential (HDR)

The objective of this designation is to provide multi-family housing of different types while maintaining an overall density of up to 21.8 units to the acre.

Typical housing types include apartments, townhouses, and a variety of cluster developments. Density may vary depending on lot sizes, off-street parking and other site constraints.

Services shall include improved streets, underground utilities (except electric transmission lines), street lighting, sidewalks, and in some cases, bikeways.

Response: As stated previously, if this application is approved, the Applicant intends to submit a Site Plan Review application for an apartment complex as sketched out in the Concept Plan in Exhibit A. As described in this section, final density will depend on site constraints and parking, but will be in line with adopted density controls. Full urban infrastructure will be required for development, including underground utilities, lighting, and street improvements as outlined in Exhibit D.

IV POPULATION GROWTH

A. HISTORIC POPULATION

Newberg grew over 500 percent from 1960 to 2010. This population growth was due to a variety of factors: regional population growth, expansion of industry and business in the area, proximity to other employment centers, and the high quality of life in the area.

Table III-1. Newberg City Population – 1960-2009

Year	Population
1960	4,204
1970	6,507
1980	10,394
1990	13,086
2000	18,064
2010	22,068

Sources: U.S. Census

The Portland State University Population Research Center estimated Newberg's population as of July 1, 2010 to be 22,110. As of July 1, 2011, the Urban Growth Boundary has an estimated population of 22,730.

B. POPULATION PROJECTIONS

Population projections are the basis of comprehensive land use planning. To maintain a high quality of living, the community must plan for its future population. Population growth will require sufficient land and services.

Many of the same factors that have contributed to Newberg's historic population growth will contribute to its future growth: employment opportunities both in Newberg and nearby, high quality of life, and regional population growth. Newberg is already experiencing a great amount of population growth due to the lack of buildable land within the Portland area.

Portland State University's Population Research Center developed a future population forecast for the Newberg Urban Area. This forecast was adopted by Yamhill County as the coordinated population forecast required by state law.

This forecast is shown in Table III-2.

Table III-2. Future Population Forecast – Newberg Urban Area

Year	Population Forecast
2015	24,663
2020	25,250
2025	32,213
2030	35,408
2032	36,610
2035	38,490

Source: Population Research Center, Portland State University, Population Forecasts for Yamhill County, its Cities and Unincorporated Area, 2011-2035, 2012.

This population forecast was used to determine future land needs within the Newberg urban area.

V. LAND NEED AND SUPPLY

A. BUILDABLE LAND INVENTORY

The Newberg Planning Division prepared an inventory of buildable land in the Newberg UGB in 2004. The buildable land inventory includes vacant and redevelopable land in the existing (2004) UGB. This land base is the starting point for determining how much future growth can be accommodated inside the existing UGB and the size of the unmet land need that must be accommodated through zone changes or UGB expansion. Physical constraints such as steep slopes (greater than 25%) and stream setbacks have been deducted from the parcel size, so the buildable land inventory is based

on buildable acres, not total acres. In addition, lands that are under development are not considered buildable. This inventory also does not include land located within the future right-of-way of the proposed Newberg-Dundee Bypass. In November 2004, the Newberg UGB had approximately 778 acres of buildable land inside the UGB (Table IV-1).

Table IV-1. Newberg UGB Buildable Land Inventory (Nov. 2004)

Plan Designation	Buildable Land
Low Density Residential	359 ac.
Medium Density Residential	142 ac.
High Density Residential	13 ac.
Commercial	105 ac.
Industrial	159 ac.
TOTAL	778 ac.

Source: Ad Hoc Committee on Newberg's Future (2005), Report to the City Council

In addition, there is approximately 467 acres of buildable land within the Newberg Urban Reserve Area. This area does not have any comprehensive plan district designations assigned.

B. HOUSING AND RESIDENTIAL LAND NEEDS

1. Housing Needs.

In order to determine the amount of residential land needed, Newberg used Johnson Gardner to create a Housing Needs Analysis. That analysis examined the demographic, housing cost, and household income data for the City of Newberg to determine the need for specific housing types: single-family, multi-family, and manufactured homes. Two adjustments were made to the Johnson Gardner residential land need analysis:

- Development projects that were in the land use approval process during the preparation of the needs analysis were subtracted from the overall 2005-2025 need.
- 49 dwelling units displaced by the proposed Newberg-Dundee Bypass were added to the housing need.

The result is the future housing needs projections shown in Table IV-2.

Table IV-2. Future Housing Need by Housing Type (number of dwelling units)

	Single Family		Multi-Family		Manufactured		Total
	Detached	Attached	Medium Density	High Density	Parks	Subdivision	
	50%	7%	15%	23%	2%	2%	100%
2005 to 2025	3,377	492	1,022	1,533	140	140	6,704
2026 to 2040	3,234	471	978	1,467	135	135	6,420
Total	6,611	963	2,000	3,000	275	275	13,124

The residential land need is determined by assigning each housing type to a comprehensive plan designation – low density residential (LDR), medium density residential (MDR), and high density residential (HDR) (Table IV-3).

Table IV-3. Housing Types by Plan and Zone Category Single Family

		Multi-Family		Manufactured	
Detached	Attached	Medium Density	High Density	Park	Subdivision
LDR	MDR	MDR	HDR	MDR	LDR
R-1	R-2	R-2	R-3	R-2	R 1

Source: Johnson Gardner

Table IV-4 presents the 2025 and 2040 housing unit need by comprehensive plan designation.

Table IV-4. Adjusted Housing Unit Need

Plan Designation	Units Needed 2005-2025	Units Needed 2026-2040
LDR	2,691	3,234
MDR	1,556	1,719
HDR	1,473	1,467
TOTAL	5,720	6,420

2. Planned Residential Densities

Table IV-5. Planned Residential Densities

		Recent Trends	Planned Density
Single Family	Units/Acre	3.6	4.4
	Average Lot Size	9,800 sf	8,000 sf
Med Density Multi-Family	Units/ Acre	5.8	9
	Type	Single Family	Townhouses and
High Density Multi-Family	Units/Acre	15.4	16.5
	Type	2 story apts with surface parking	2-3 story apts with surface
Average	Units/Acre	6.8	8.3

3. Residential Land Need

The total amount of residential land needed for housing was calculated by dividing the dwelling units needed by the planned residential densities. The total buildable residential land needs through 2025 2030 and 2040 are shown in Table IV-6.

Table IV-6. Buildable Residential Land Need

Plan Designation	Density (du/ac.)	Dwelling Units Needed (2005-2025)	Buildable Acres Needed (2005-2025)	Dwelling Units Needed (2026-2040)	Buildable Acres Needed (2026-2040)
LDR	4.4	2,691	612	3,234	735
MDR	9	1,556	173	1,719	191
HDR	16.5	1,473	89	1,367	83
Total		5,720	874	6,320	1,009

4. Residential Land Need and Supply

Comparing the residential land need the current supply, the City has a deficit of residential land to meet needs through 2025 in all residential categories. It also has a deficit of land within the URA to meet the

needs from 2026-2040. Table IV-7 compares the amount of residential land with the available supply.

Table IV-7: Buildable Residential Land Needs vs. Supply

Plan Designation	Buildable Acres Needed 2005-2025	Buildable Acres in UGB (2004)	Surplus (Deficit) for 2005-2025	Buildable Acres Needed 2026-2040
LDR	612	359	(253)	735
MDR	173	142	(31)	191
HDR	89	13	(76)	83
Total	874	514	(380)	1009

F. SUMMARY OF LAND NEEDS

Table IV-14 summarizes the future land needs for the Newberg urban area.

Table IV-14. Future Land Needs and Supply, Newberg Urban Area

Plan Designation	Buildable Acres Needed 2005-2025	Buildable Acres in UGB (2004)	Surplus (Deficit) for 2005-2025	Buildable Acres Needed 2026-2040	Buildable Acres In URA (2004)	Surplus (Deficit) 2026-2040
LDR	612	359	(253)	735		
MDR	173	142	(31)	191		
HDR	89	13	(76)	83		
COM	111	105	(6)	109		
IND	50	99	49	37		
IND (Large Site)	100	60	(40)	120		
P	85	0	(85)	115		
I, PQ, or other Inst.	164	0	(164)	233		
Total	1,384	778	(606)	1,623	467	(1,156)

Response: The housing analysis in the adopted Comprehensive Plan dates from 2004. In 2009, Newberg proposed an update to the Housing Element of the Comprehensive Plan parallel with an effort to add industrial land on the south end of town for future employment growth. That effort has been stalled by appeal with LUBA and now enters into an unprecedented mediation process. In October 2012, the Yamhill County Planning Commission adopted a new coordinated population forecast for the Newberg UGB through 2035 based on 2010 census data as well as a report titled "Population Forecasts for Yamhill County, its Cities and Unincorporated Areas 2011-2035" prepared by Portland State University Population Research Center.

Cogan Owens Greene prepared a Housing Needs Analysis (Exhibit G) based on the 2009 inventory updated with current GIS data provided by City Staff, the projections from the Portland State Report, and refined for the remand findings from LUBA. This supplemental report is included in Exhibit G. It confirms that there will be a shortage of land available in 2030 for LDR, MDR, and HDR lands:

Plan Designation	Buildable Acres Needed	Buildable Acres in UGB	(Deficit)	Percentage of Available Capacity
LDR	406	369	(37)	91%
MDR	179	92	(87)	51%
HDR	62	7	(55)	11%
Total	647	468	(179)	72%

While all lands show a shortage, the greatest percentage shortage is HDR with only seven buildable acres within City limits, and the lowest shortage is LDR. It should also be noted that the most efficient use of scarce residential land is HDR. The proposed Comprehensive Plan Amendment and Zone Change would help preserve as much residential opportunity as possible and improve the diversity of housing opportunities. While the City works diligently to resolve the UGB stalemate, it is important to understand the significant shortage of HDR lands across the City. When the UGB is expanded, there is still a need to disperse the available HDR lands throughout the City where there is convenient access to employment and services. Martell Commons is an ideal geographic location to provide diversity for the housing needs of Newberg, consistent with other goals and policies of the Comprehensive Plan addressed above.

IV. CONCLUSION

The listed findings and accompanying documentation demonstrates that the proposal is consistent with the applicable provisions of the City of Newberg Development Code and Comprehensive Plan. The applicant respectfully requests approval of the proposed Martell Commons Comprehensive Plan Amendment and Zone Change Application.

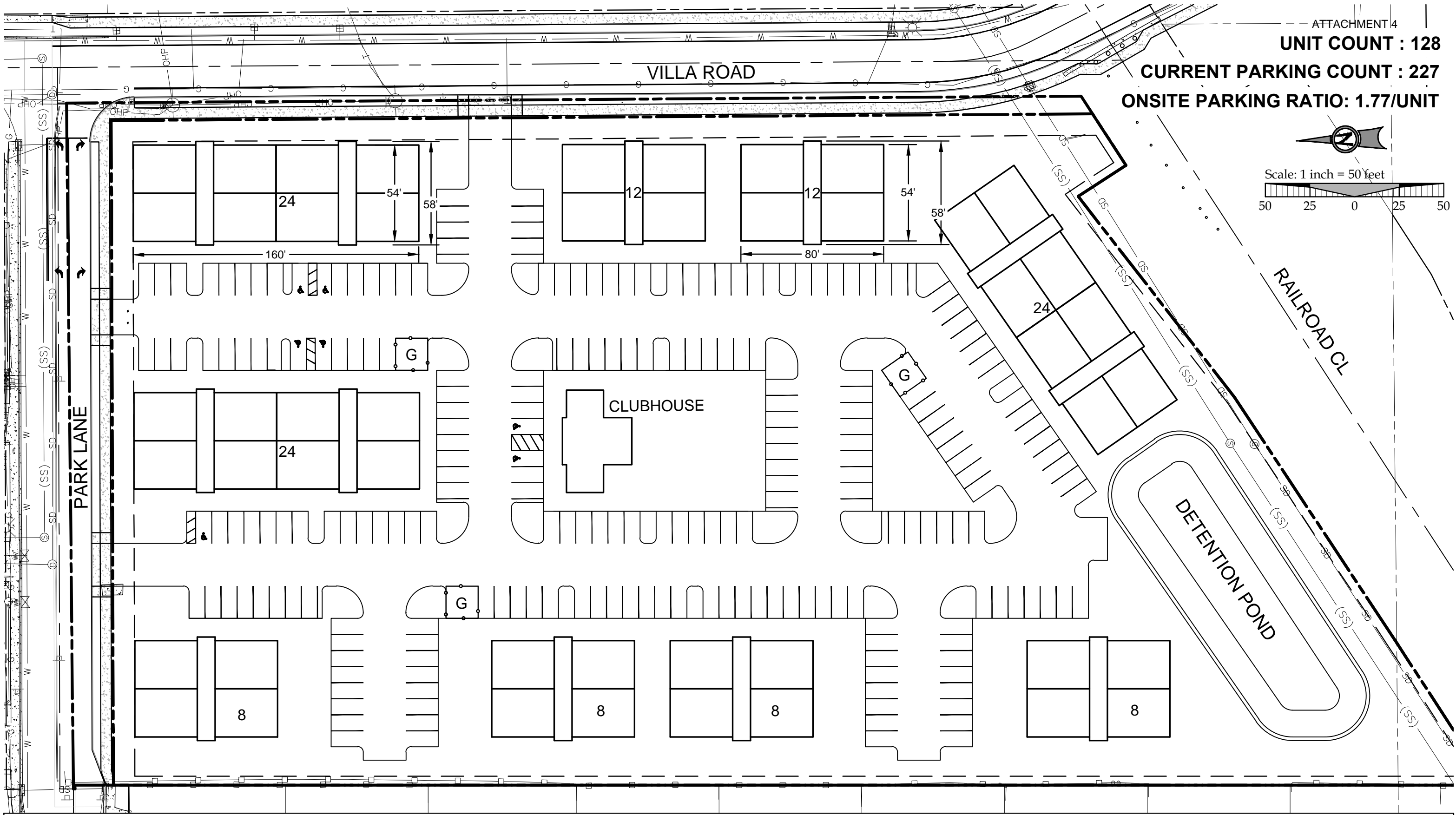
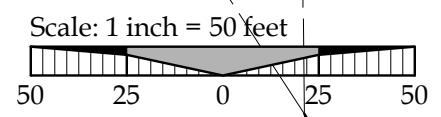

EXHIBIT A: CONCEPTUAL SITE PLAN

UNIT COUNT : 128

CURRENT PARKING COUNT : 227

ONSITE PARKING RATIO: 1.77/UNIT



3J CONSULTING, INC



128-UNIT SITE PLAN MARTELL COMMONS

511/690

Exhibit Use

OPTION 9

Date: 2015-01-27

By:CKW

NOT FOR CONSTRUCTION

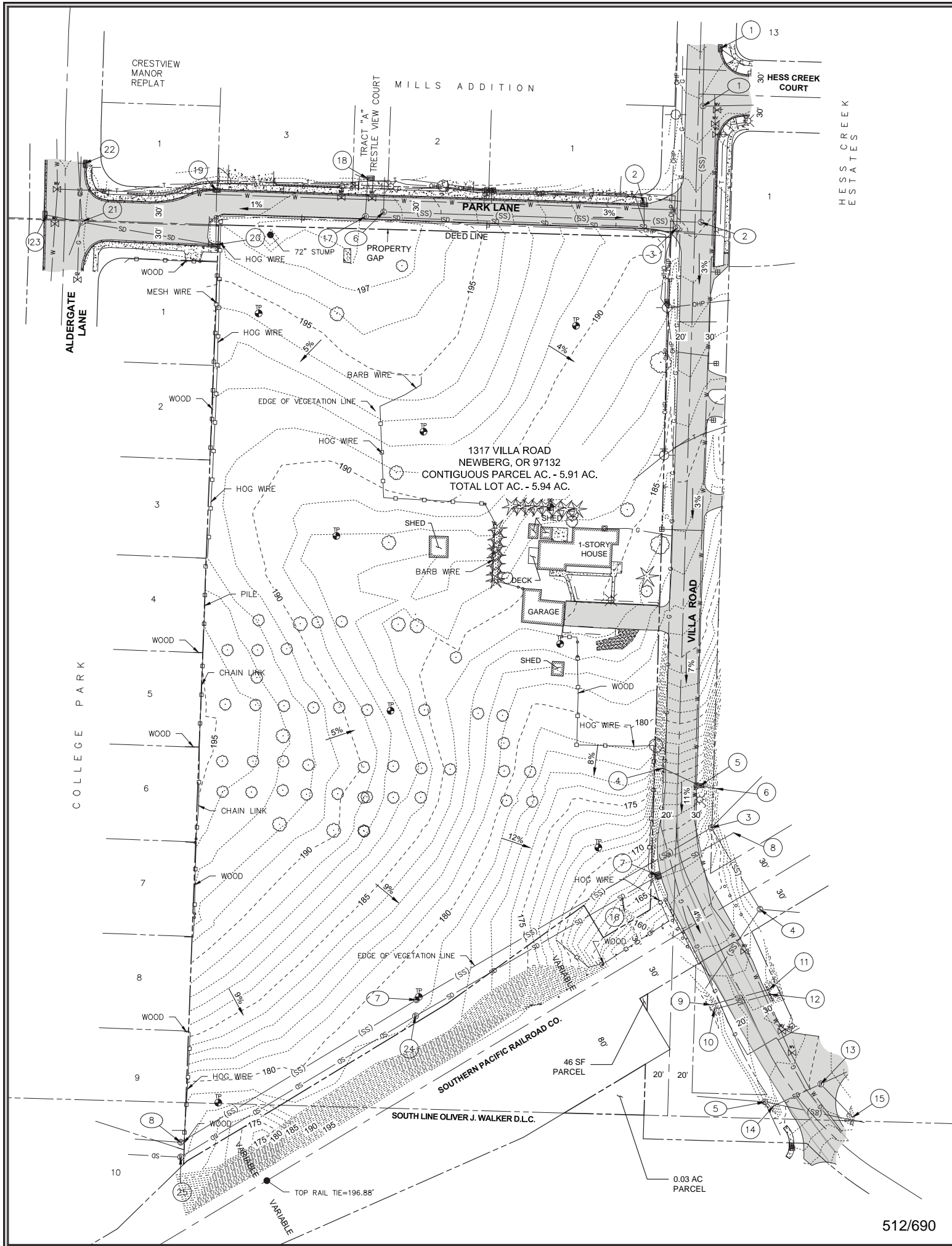

- STORM SEWER DATA:**
- 1 STORM SEWER CATCH BASIN
RIM=193.41'
IE 12" CONC (SE)=190.21'
 - 2 STORM SEWER CATCH BASIN
RIM=189.01'
IE 8" (S)=
 - 3 STORM SEWER MANHOLE
RIM=189.77'
IE 4" PVC (NW)=187.00' +/-
IE 12" CONC (N)=187.07'
IE 12" CONC (S)=186.3' +/-
IE 12" CONC (W)=186.2' +/-
*RECESSED/FULL OF SILT AND DEBRIS
 - 4 IE 12" CONC (SE)=170.99'
 - 5 STORM SEWER CATCH BASIN
RIM=167.63'
IE 12" CONC (NW)=165.38'
IE 12" PVC (E)=164.23'
 - 6 IE 12" PVC (W)=159.17'
 - 7 STORM SEWER CATCH BASIN
RIM=161.90'
IE 21" CMP (SW)=159.55'
IE 21" CMP (NE)=159.45'
 - 8 IE 21" CMP (SW)=155.89'
 - 9 IE 30" CMP (E)=152.74'
 - 10 IE 60" CMP (E)=151.34'
 - 11 IE 30" CMP (W)=152.50'
 - 12 IE 60" CMP (W)=151.42'
 - 13 STORM SEWER MANHOLE
RIM=159.82'
IE 36" CONC (SE)=155.32'
IE 36" CMP (SW)=155.12'
 - 14 IE 36" CMP (NE)=153.84'
 - 15 IE 36" CONC (NW)=155.31'
 - 16 IE 4" FRENCH DRAIN X2 (N)=162.54'
 - 17 STORM SEWER MANHOLE
RIM=196.74'
IE 12" PVC (N)=192.86'
IE 12" PVC (E)=192.68'
 - 18 STORM SEWER CATCH BASIN
RIM=196.68'
IE 8" CONC (S)=194.91'
 - 19 STORM SEWER CATCH BASIN
RIM=195.03'
IE 8" CONC (S)=193.87'
 - 20 STORM SEWER CATCH BASIN
RIM=195.14'
IE 8" CONC (N)=193.54'
IE 12" CONC (W)=193.47'
 - 21 STORM SEWER MANHOLE
RIM=196.01'
IE 12" CONC (E)=192.73'
IE 12" CONC (W)=191.95'
IE 24" CMP (N)=191.73'
IE 24" CMP (SW)=191.73'
 - 22 STORM SEWER CATCH BASIN
RIM=196.55'
IE 12" CONC (W)=193.24'
 - 23 STORM SEWER CATCH BASIN
RIM=196.01'
IE 12" CONC (E)=192.29'
 - 24 STORM SEWER MANHOLE
RIM=178.32'
IE 24" CMP (SW)=170.72'
IE 24" CMP (NE)=170.57'
 - 25 STORM SEWER MANHOLE
RIM=179.51'
IE 24" CMP (SW)=174.61'
IE 24" CMP (NE)=174.51'
- SANITARY SEWER DATA:**
- 1 SANITARY SEWER MANHOLE
RIM=192.74'
IE 8" PVC (S)=185.49'
IE 8" PVC (N)=185.34'
IE 8" PVC (E)=185.24'
 - 2 SANITARY SEWER MANHOLE
RIM=190.20'
IE 8" PVC (W)=186.05'
IE 8" PVC (N)=185.95'
 - 3 SANITARY SEWER MANHOLE
RIM=162.67'
*SPECIAL RIM ON MH- UNABLE TO OPEN
 - 4 SANITARY SEWER MANHOLE
RIM=157.77'
*SPECIAL RIM ON MH- UNABLE TO OPEN
 - 5 SANITARY SEWER MANHOLE
RIM=159.29'
IE 8" PVC (S)=150.19'
IE 8" PVC (E)=149.69'
IE 8" PVC (W)=149.49
 - 6 SANITARY SEWER MANHOLE
RIM=196.42'
IE 8" PVC (N)=187.53'
IE 8" PVC (E)=187.41'
 - 7 SANITARY SEWER MANHOLE
RIM=178.27'
IE 8" PVC (SW)=170.84' (INACTIVE)
IE 8" PVC (SW)=167.82'
IE 8" PVC (NE)=167.59'
 - 8 SANITARY SEWER MANHOLE
RIM=179.70'
IE 8" PVC (SW)=174.12'
IE 8" PVC (W)=174.07'
IE 8" PVC (NE)=173.65'

NOTES

- THE ELEVATION DATUM FOR THIS SURVEY IS NGVD29 ELEVATION=190.35'
HDJ CONTROL POINT NUMBER: 1
THE BENCHMARK IS A MAG NAIL WITH WASHER LOCATED AT THE NORTHWEST CORNER OF THE INTERSECTION OF PARK LANE AND VILLA ROAD, APPROXIMATELY 4.6 FEET NORTHEAST OF THE END OF A CONCRETE CURB RUN AND APPROXIMATELY 29.3 FEET NORTHEAST OF THE CENTER OF A CATCH BASIN. *BENCHMARK ELEVATIONS WERE TRANSFERRED TO SITE CONTROL POINTS THROUGH DIFFERENTIAL LEVELS (CITY OF NEWBERG BENCHMARK #66- SOUTHEAST CORNER OF VILLA ROAD AND HESS CREEK COURT INTERSECTION, ELEVATION=192.22').
- THE HORIZONTAL DATUM FOR THIS SURVEY IS NAD 83(2011), STATE PLANE OREGON NORTH (ZONE 3601)
- THE UNDERGROUND UTILITIES SHOWN HEREON WERE BASED ON UTILITY LOCATE PAINT MARKS SUPPLIED BY THE OREGON UTILITY NOTIFICATION CENTER AS WELL AS SURFACE EVIDENCE AND PRIVATE ASBUILT RECORDS. HOWEVER, LACKING EXCAVATION, THE EXACT LOCATION OF UNDERGROUND FEATURES CANNOT BE ACCURATELY, COMPLETELY AND RELIABLY DEPICTED. WHERE ADDITIONAL OR MORE DETAILED INFORMATION IS REQUIRED, THE CLIENT IS ADVISED THAT EXCAVATION MAY BE NECESSARY.

ATTACHMENT

INTERNAL REVIEW 9/26/14 BY [signature]

LEGEND: EXISTING CONDITIONS

	EXISTING BUILDING LINE
	EXISTING BUILDING HATCH
	PROJECT BOUNDARY
	RIGHT-OF-WAY LINE
	RIGHT-OF-WAY CENTERLINE
	EXISTING ADJACENT PROPERTY LINE
	EXISTING CONCRETE HATCH
	EXISTING CONCRETE LINE
	EXISTING CURB
	EXISTING EDGE OF PAVEMENT LINE
	EXISTING ASPHALT HATCH
	EXISTING GRAVEL LINE
	EXISTING GRAVEL HATCH
	EXISTING FENCE LINE
	EXISTING STRIPING: WHITE
	EXISTING STRIPING: YELLOW
	EXISTING TELECOM LINE
	EXISTING GAS LINE
	EXISTING CABLE LINE
	EXISTING UNDERGROUND POWER
	EXISTING OVERHEAD POWER
	EXISTING UNSPECIFIED OVERHEAD WIRE
	EXISTING VEGETATION LIMITS LINE
	EXISTING SANITARY SEWER
	EXISTING STORM DRAIN
	EXISTING COMBINED SEWER
	EXISTING WATER MAIN
	EXISTING MAJOR CONTOUR
	EXISTING MINOR CONTOUR
	EXISTING FIRE HYDRANT
	EXISTING WATER VALVE
	EXISTING WATER METER
	EXISTING CONIFEROUS TREE
	EXISTING DECIDUOUS TREE
	EXISTING SIGN
	EXISTING UTILITY POLE
	EXISTING SANITARY MANHOLE
	EXISTING STORM MANHOLE
	EXISTING STORM INLET
	EXISTING LIGHT
	EXISTING UTILITY POLE
	EXISTING GAS METER
	EXISTING TELEPHONE PEDESTAL

EXISTING CONDITIONS
MARTELL COMMONS
APARTMENTS
D12
NEWBERG, OR

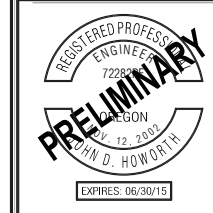

3J CONSULTING, INC
CIVIL ENGINEERING
WATER RESOURCES
LAND USE PLANNING
5075 SW GRIFFITH DRIVE, SUITE 150, BEAVERTON, OR 97005
PHONE & FAX: (503) 546-5365

3J JOB ID # | 14225
LAND USE # |
TAX LOT # |
DESIGNED BY | CKW
CHECKED BY | JDH
SHEET TITLE
EX.COND
SHEET NUMBER

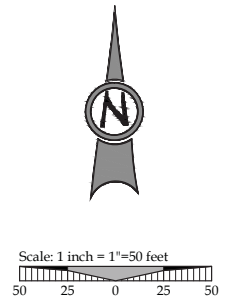

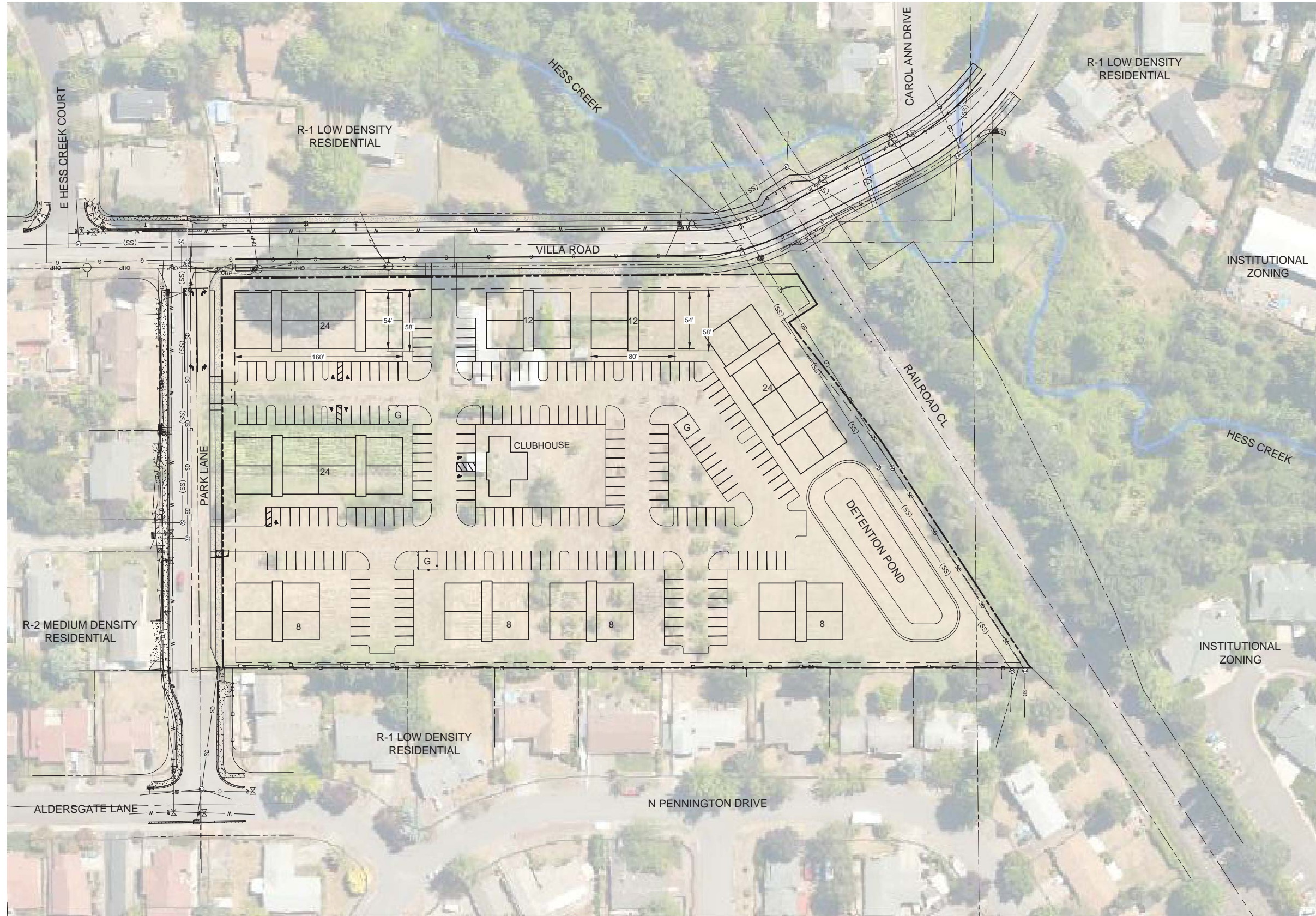

UNIT COUNT : 128
 CURRENT PARKING COUNT : 227
 ONSITE PARKING RATIO: 1.77/UNIT

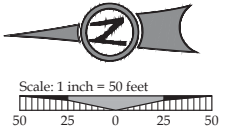

513/690

REVISION SUMMARY BY DATE

SITE PLAN WITH AERIAL
MARTELL COMMONS

 DJ2
 NEWBERG, OREGON

EXHIBIT
 USE
 ONLY

3J CONSULTING, INC

 CIVIL ENGINEERING
 WATER RESOURCES
 LAND USE PLANNING
 4780 S.W. JOSHUA STREET SUITE 200, TUALATIN, OR 97063
 PHONE: (503) 946-3865 FAX: (503) 885-8253

3J JOB ID # | 14225
 LAND USE # | ###
 TAX LOT # | 1317 VILLA ROAD
 DESIGNED BY | CKW
 CHECKED BY | JDH

SHEET TITLE
SITE PLAN
 SHEET NUMBER



EXHIBIT B: COUNTY TAX MAP AND TRIO



OWNERSHIP INFORMATION

Owner	: Martell Family Farm LLC	Ref Parcel #	: R3217BC 00800
CoOwner	:	T : 03S R: 02W S : 17 Q : NW QQ : SW	
Site Address	: 1317 Villa Rd Newberg 97132	Parcel #	: 33476
Mail Address	: 23480 NE Hyland Dr Newberg Or 97132	MHLotAPN	:
Telephone	:	County	: Yamhill (OR)

ASSESSMENT AND TAX INFORMATION

Mkt Land : \$581,177
Mkt Structure : \$87,622
Mkt Total : \$668,799
%Improved : 13
Assessed Land :
Assessed Structure:
Assessed Total :
Levy Code : 29.0
13-14 Taxes : \$2,794.87
Millage Rate : 16.6775

PROPERTY DESCRIPTION

MapPageGrid : 713 D6
Census Tract : 302.01 Block : 4
Neighborhood : *UNKNOWN NEIGHBORHOOD CODE*
Subdivision/Plat :
Special District :
Zoning : 54 FARM LAND, UNZONED
Stat Class : 141 One Story
Land Use : 541 Farm, Unzoned Farm Land, Imp
Legal : POTENTIAL ADDITIONAL TAX LIABILITY
: 7.10 ACRES IN SEC 17 T3S R2W
:

PROPERTY CHARACTERISTICS

Bedrooms	: 3	Building Living SF	: 1,728	Year Built	: 1940
Bathrooms	: 2.00	Building Total SF	: 1,728	Garage Type	: Grg-Det-Unfin
Fireplace	: Stovepad	1st Floor SF	: 1,728	Garage SF	: 848
Fireplace 2	: Stovepad	Second Floor SF	:	Lot Acres	: 7.10
Heat A/C	: Baseboard	Third Floor SF	:	Lot SF	: 309,276
Heat A/C2	:	Cellar SF	:	Wall Material	: Bevel Vinyl
Dishwasher	:	Basement Total SF	:	Floor Base	: Double
Roof Material	: Comp Shingle	Basement Type	:	Floor Cover	:
Roof Shape	: Gable	Foundataion	:		

Mobile Home		Farm Buildings	Size
ID Number	:	1. Leanto/4X6-Gal Roof-Dirt	324
Title	:	2. General Purpose Building	1,440
Make	:	3. Machine Shed	288
Dimensions	:	4. Multi-Purpose Shed	120
Skirt	:	5.	

TRANSFER HISTORY

Owner(s)	Date	Doc #	Price	Deed	Loan	Type
:Martell Family Farm LLC	:10/29/2010	15188	:	:Correction	:	:
:Martell Family Farm LLC	:09/15/2010	12791	:	:Bargain & Sale	:	:
:	:	:	:	:	:	:
:	:	:	:	:	:	:
:	:	:	:	:	:	:
:	:	:	:	:	:	:



Reference Parcel #: R3217BC 00800

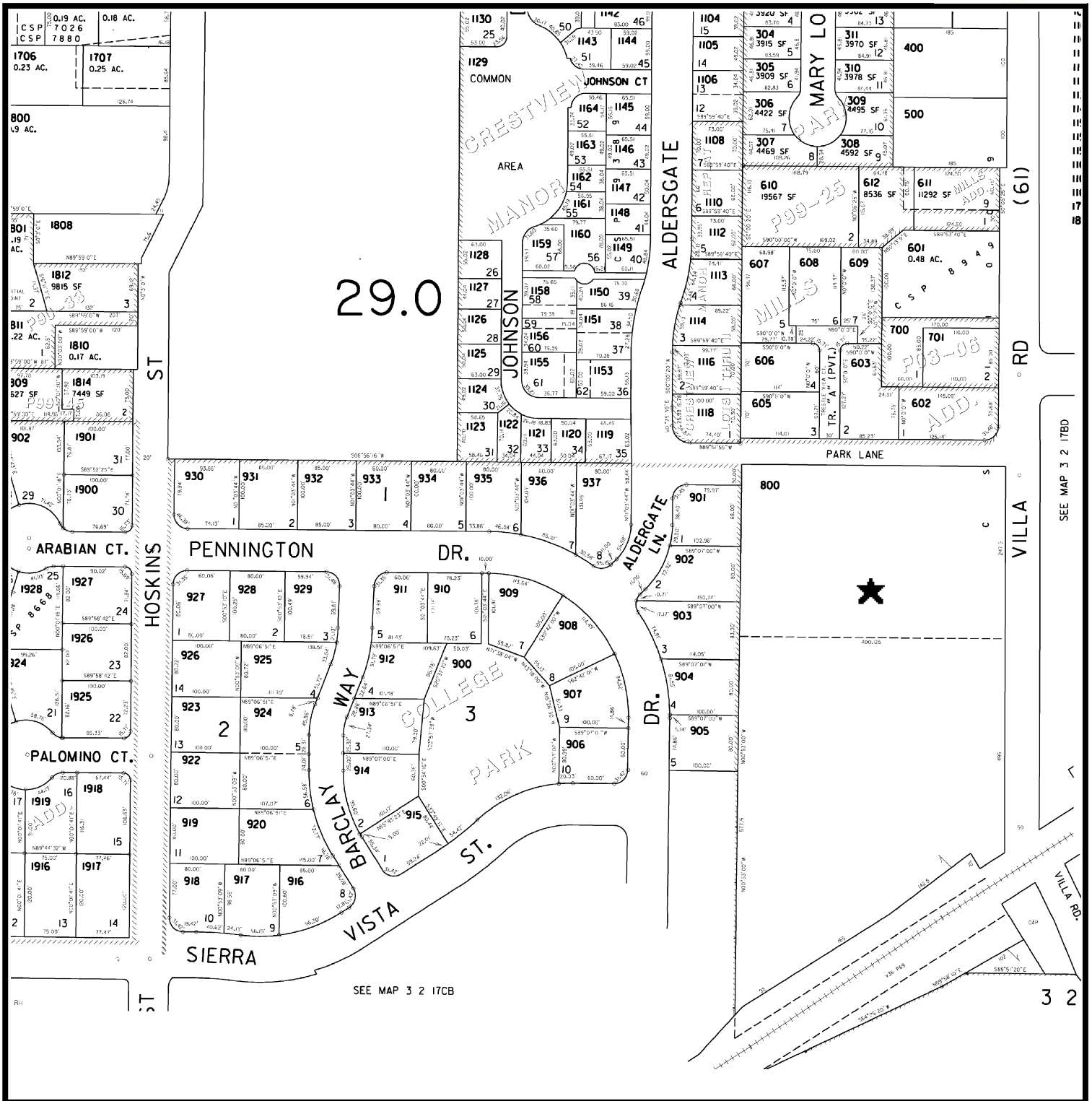

First American
Title Company of Oregon

Customer Service Department
 121 SW Morrison Street Suite 300 Portland, OR 97204
 Phone: 503.219.TRIO (8746) Fax: 503.790.7872
 Email: cs.portland@firstam.com



Reference Parcel #: R3217BC 00800

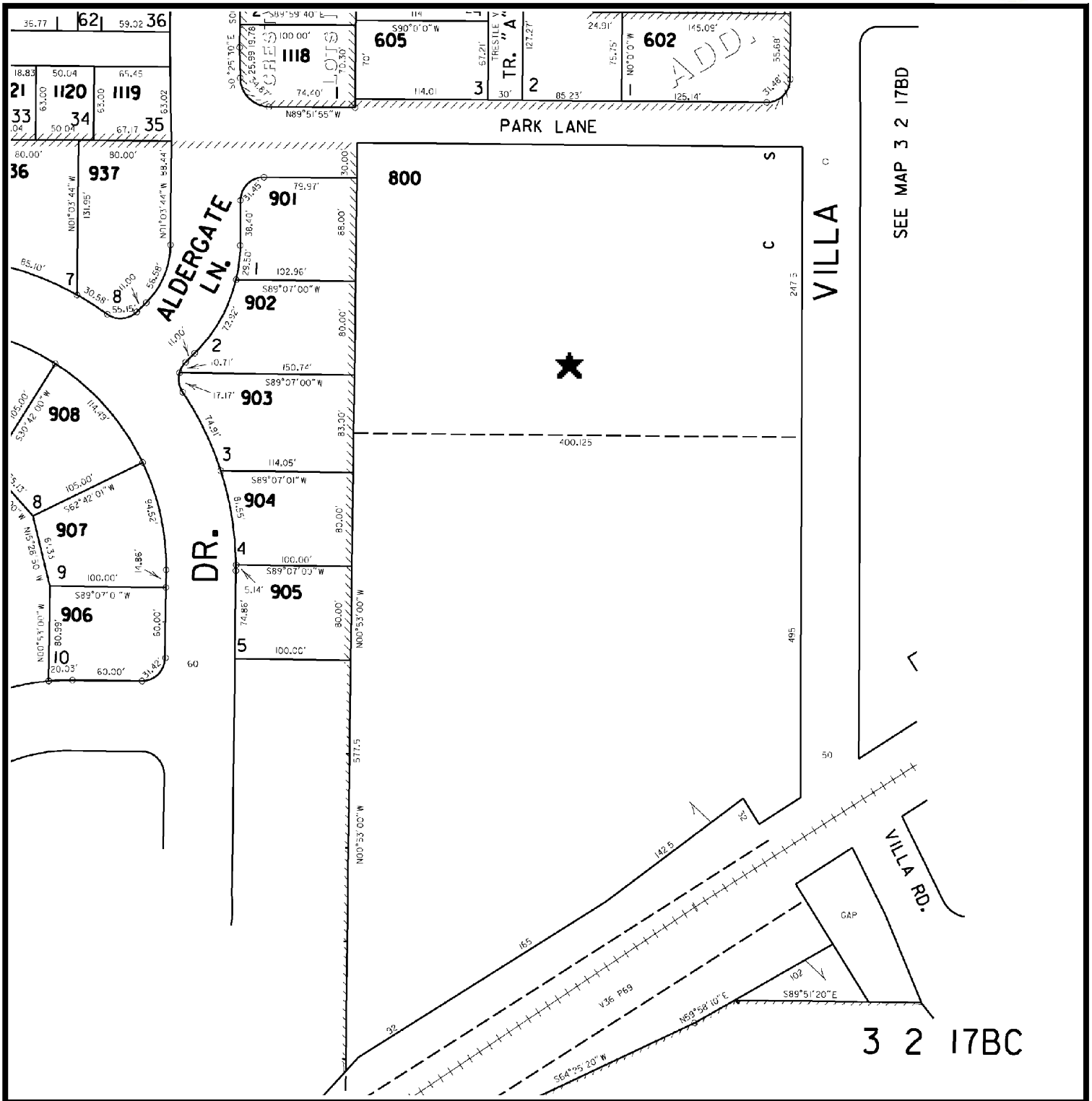

SEE MAP 3 2 17BD

3 2 17BC



First American Title Company of Oregon

Customer Service Department
121 SW Morrison Street Suite 300 Portland, OR 97204
Phone: 503.219.TRIO (8746) Fax: 503.790.7872
Email: cs.portland@firstam.com

Douglas R. Martell, as Successor Trustee to the Martell Family Trust, dated September 16, 1997, GRANTOR
23480 NE Hyland Drive
Newberg, OR 97132

Martell Family Farm, LLC,
an Oregon limited liability company, GRANTEE
23480 NE Hyland Drive
Newberg, OR 97132

TAX STATEMENTS TO BE SENT TO:

Martell Family Farm, LLC,
an Oregon limited liability company, GRANTEE
23480 NE Hyland Drive
Newberg, OR 97132

After recording, return to:

Ron D Ferguson
4004 Kruse Way Place, Suite 200
Lake Oswego, OR 97035

OFFICIAL YAMHILL COUNTY RECORDS
REBEKAH STERN DOLL, COUNTY CLERK

201015188



\$46.00

10/29/2010 03:48:55 PM

DMR-DDMR Cnt=1 Stn=2 ANITA
\$10.00 \$10.00 \$11.00 \$15.00

BARGAIN AND SALE DEED – STATUTORY FORM

Being recorded to correct legal description, previously recorded as document #201012791.

Douglas R. Martell, as Successor Trustee to the Martell Family Trust, dated September 16, 1997, Grantor, conveys to Martell Family Farm, LLC, an Oregon limited liability company, Grantee, all of Grantor's right, title and interest in the following described real property situated in Yamhill County, Oregon to wit:

SEE EXHIBIT A

The true consideration for this conveyance is -\$0- and constitutes a transfer by a trust into an entity in which the ultimate beneficiaries possess an ownership interest.

DATED this 26th day of October 2010.

BEFORE SIGNING OR ACCEPTING THIS INSTRUMENT, THE PERSON TRANSFERRING FEE TITLE SHOULD INQUIRE ABOUT THE PERSON'S RIGHTS, IF ANY, UNDER ORS 195.300, 195.301 AND 195.305 TO 195.336 AND SECTIONS 5 TO 11, CHAPTER 424, OREGON LAWS 2007. THIS INSTRUMENT DOES NOT ALLOW USE OF THE PROPERTY DESCRIBED IN THIS INSTRUMENT IN VIOLATION OF APPLICABLE LAND USE LAWS AND REGULATIONS. BEFORE SIGNING OR ACCEPTING THIS INSTRUMENT, THE PERSON ACQUIRING FEE TITLE TO THE PROPERTY SHOULD CHECK WITH THE APPROPRIATE CITY OR COUNTY PLANNING DEPARTMENT TO VERIFY THAT THE UNIT OF LAND BEING TRANSFERRED IS A LAWFULLY ESTABLISHED LOT OR PARCEL, AS DEFINED IN ORS 92.010 OR 215.010, TO VERIFY THE APPROVED USES OF THE LOT OR PARCEL, TO DETERMINE ANY LIMITS ON LAWSUITS AGAINST FARMING OR FOREST PRACTICES, AS DEFINED IN ORS 30.930, AND TO INQUIRE ABOUT THE RIGHTS OF NEIGHBORING PROPERTY OWNERS, IF ANY, UNDER ORS 195.300, 195.301 AND 195.305 TO 195.336 AND SECTIONS 5 TO 11, CHAPTER 424, OREGON LAWS 2007.

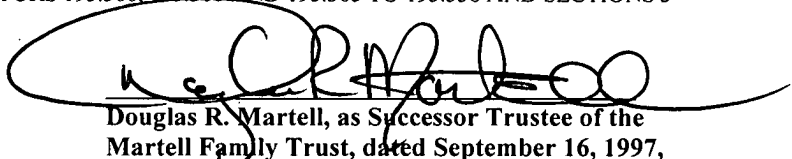
Douglas R. Martell, as Successor Trustee of the
Martell Family Trust, dated September 16, 1997,
Grantor

STATE OF OREGON)
) ss
County of Clackamas)

This instrument was acknowledged before me this 26th day of October 2010, by Douglas R. Martell, as Successor Trustee to the Martell Family Trust, dated September 16, 1997, Grantor.

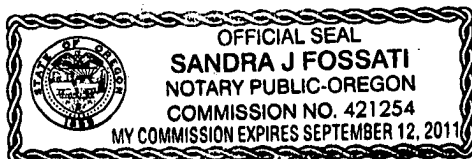



Notary Public of Oregon

EXHIBIT AParcel 1

Being a part of the D. D. Deskins and O. J. Walker Donation Land Claims, in Section 17, Township 3 South Range 2 West in Yamhill County, Oregon, and described as follows, to-wit: Beginning at a point on the South line of the O. J. Walker D. L.C., said point being 104 rods East of the West side of Section 17; thence North 30 rods to South line of ten acre tract deeded to Ervin Scott; thence West $24 \frac{1}{4}$ rods; thence South parallel with East line 35 rods, more or less to the North line of the R. R. right of way; thence Northeasterly along said right of way to intersection of the South line of the O. J. Walker D.L.C.; thence East to place of beginning, excepting R.R. right of way through said premises.

Also the following tract: Being a part of the O. J. Walker D.L.C. in section 17, Township 3 South, Range 2 West Yamhill County, Oregon, described as follows: Beginning at a point 64 rods West of the Southeast corner of said Claim, thence running West 5 rods to the Southeast corner of Jos. Hoskins land; thence North 6 rods to the South line of the P. and W.V.R.R.; thence running Easterly along said South line of the P. and W.V.R.R. $3 \frac{1}{2}$ rods; thence running Southeasterly about 7 or 8 rods to the place of beginning, containing 30/160 acres more or less.

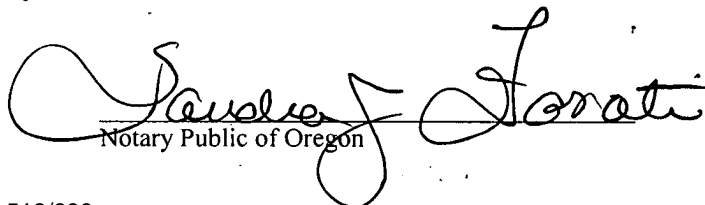
The above two tracts of land containing in all about 5 acres more or less, excepting R.R. right of way.

Parcel 2

A tract of land located in Yamhill County, Oregon, and being a part of the Donation Land Claim of Oliver J. Walker in Township 3 South, Range 2 West of the Willamette Meridian in Yamhill County, and more particularly described as follows:

Beginning at a point 30 rods North of the South boundary line of said Claim and 104 rods East of the Section line between Sections 17 and 18 in said Township and Range; and said point being at the Southeast corner of that certain tract of land conveyed to Ervin Scott by J. L. Hoskins and Mary L. Hoskins by deed recorded at Page 281 in Book 31 of Deed Records of Yamhill County, and running thence West $24\text{-}1/4$ rods; thence North 15 rods; thence East $24\text{-}1/4$ rods; thence South 15 rods to the place of beginning.



EXHIBIT C: APPLICATION FORM



**TYPE III APPLICATION - 2014
(QUASI-JUDICIAL REVIEW)**

File #: _____

TYPES – PLEASE CHECK ONE:

- | | |
|--|--|
| <input type="checkbox"/> Annexation | <input type="checkbox"/> Conditional Use Permit |
| <input checked="" type="checkbox"/> Comprehensive Plan Amendment (site specific) | <input type="checkbox"/> Type III Major Modification |
| <input checked="" type="checkbox"/> Zoning Amendment (site specific) | <input type="checkbox"/> Planned Unit Development |
| <input type="checkbox"/> Historic Landmark Modification/alteration | <input type="checkbox"/> Other: (Explain) _____ |

APPLICANT INFORMATION:

APPLICANT: DJ2 Holdings
 ADDRESS: 8931 SE Foster Rd. Suite 210 Portland, OR 97266
 EMAIL ADDRESS: jeff@dj2holdings.com
 PHONE: _____ MOBILE: 503-201-8616 FAX: _____
 OWNER (if different from above): Martell Family Farms, LLC PHONE: _____
 ADDRESS: 23480 NE Hyland Dr Newberg, OR 97132
 ENGINEER/SURVEYOR: John Howorth, 3J Consulting PHONE: 503-946-9365
 ADDRESS: 5075 Southwest Griffith Drive Suite 150, Beaverton, OR 97005

GENERAL INFORMATION:

PROJECT NAME: Martell Commons PROJECT LOCATION: 1317 Villa Road
 PROJECT DESCRIPTION/USE: Comprehensive Plan Amendment/Zone Change/DR for an Apartment Complex
 MAP/TAX LOT NO. (i.e. 3200AB-400): 3217BC 00800 ZONE: R-1 SITE SIZE: 6.0 SQ. FT. ACRE
 COMP PLAN DESIGNATION: LDR TOPOGRAPHY: Gradual slope to the South
 CURRENT USE: Rural residential
 SURROUNDING USES:
 NORTH: Residential SOUTH: Hess Creek/railroad/George Fox
 EAST: Residential WEST: Hess Creek/Residential

SPECIFIC PROJECT CRITERIA AND REQUIREMENTS ARE ATTACHED

General Checklist: Fees Public Notice Information Current Title Report Written Criteria Response Owner Signature

For detailed checklists, applicable criteria for the written criteria response, and number of copies per application type, turn to:

Annexationp. 15
 Comprehensive Plan / Zoning Map Amendment (site specific)p. 19
 Conditional Use Permitp. 21
 Historic Landmark Modification/Alterationp. 23
 Planned Unit Developmentp.26

The above statements and information herein contained are in all respects true, complete, and correct to the best of my knowledge and belief. Tentative plans must substantially conform to all standards, regulations, and procedures officially adopted by the City of Newberg. All owners must sign the application or submit letters of consent. Incomplete or missing information may delay the approval process.

[Signature] 2/16/15
 Applicant Signature Date
JEFF CURRAN
 Print Name

[Signature] 02-06-2015
 Owner Signature Date
Martell Family Farm LLC
 Print Name

Attachments: General Information, Fee Schedule, Noticing Procedures, Planning Commission Schedule, Criteria, Checklists



EXHIBIT D: INFRASTRUCTURE CAPACITY ANALYSIS



TECHNICAL MEMORANDUM

To: Mimi Doukas, AICP
Land Use Planner

From: John Howorth, PE
Civil Engineer

Date: February 6, 2015

Project Name: Martell Commons
Project No: 14225
RE: Infrastructure Review

This technical memorandum is being prepared to summarize the current status of the surrounding infrastructure, the potential impacts associated with the zone change, and any mitigation of the impacts that will be required by the City of Newberg. The infrastructure discussed within this memo includes water, sanitary sewer, and storm water.

Zone Change

The proposed zone change from R-1 to R-3 will allow for an increased density potential for the subject parcel. The increase in density will increase the use of potable water and subsequently create higher sanitary sewer flows, as well as increase the number of vehicle trips generated by the project. Storm water runoff may increase slightly due to the potential to have more impervious area.

Potable Water

Existing Conditions:

The City of Newberg currently has 3 reservoirs, one at Corral Creek, and two at North Valley. Each reservoir is understood to have a capacity of 4 million gallons each.

Impacts & Mitigation:

The zone change will generate a slight increase in the demand for potable water and fire, but not a significant impact. It is understood that the existing system is more than capable of handling the added demand from the zone change and that no additional reservoir capacity is needed.

As part of the final development of the property a fire flow analysis will be performed to determine if any existing water lines would need to be upsized. Water lines will be extended through the site to provide both domestic water services and fire hydrants for the development. These extensions will be provided by the developer.

Storm Water

Existing Conditions:

Currently the site consists of a single family home with a detached garage and two sheds. The site is predominately vegetated.

Impacts & Mitigation:

The zone change will allow for a more dense development to occur; however this does not typically correlate to a proportional increase in runoff. Rather, the amount of storm water runoff is directly related to the amount of impervious surface created with the development. All storm water will be treated for water quality before being released into any municipal system. The development will follow City standards water quality and detention.

Sanitary Sewer

Existing Conditions:

The site abuts a 12-inch public sanitary sewer line that runs along Hess Creek to the south and east of the property. The current City of Newberg Sewer Master Plan shows capacity for the proposed increased density associated with the zone change within the public sewer system directly adjacent to the site with the system flowing under surcharged conditions further downstream.

Impacts & Mitigation:

Development of the subject property under its current R-1 zone would yield a projected sewer demand of 1,225-gpm at the point in which flows would enter the system. The increase in allowed density associated with a zone change to R-3 could generate a sewer demand of up to 1,242-gpm (assuming low flow plumbing fixtures and an I/I peaking factor of 3 for new pipe rather than a peaking factor of 4). The total existing flow in the 12-inch sewer, based on the City's master plan, is approximately 1,203-gpm. While the zone change would create a slight increase in sewer flows, the relative increase to the existing system is only 3.2%, and only 1.4% over the allowed R-1 zoning. This is within the margin of error of the flow modeling that backstops the City's Master Plan. The system is currently under review by the City Engineering department and we anticipate that flow testing will be conducted to confirm the assumptions used in developing the master plan. At this time there is no indication of any improvements necessary to the system based on the minimal increases to the sewer flows as a result of the zone change.

- - - END OF DOCUMENT - - -



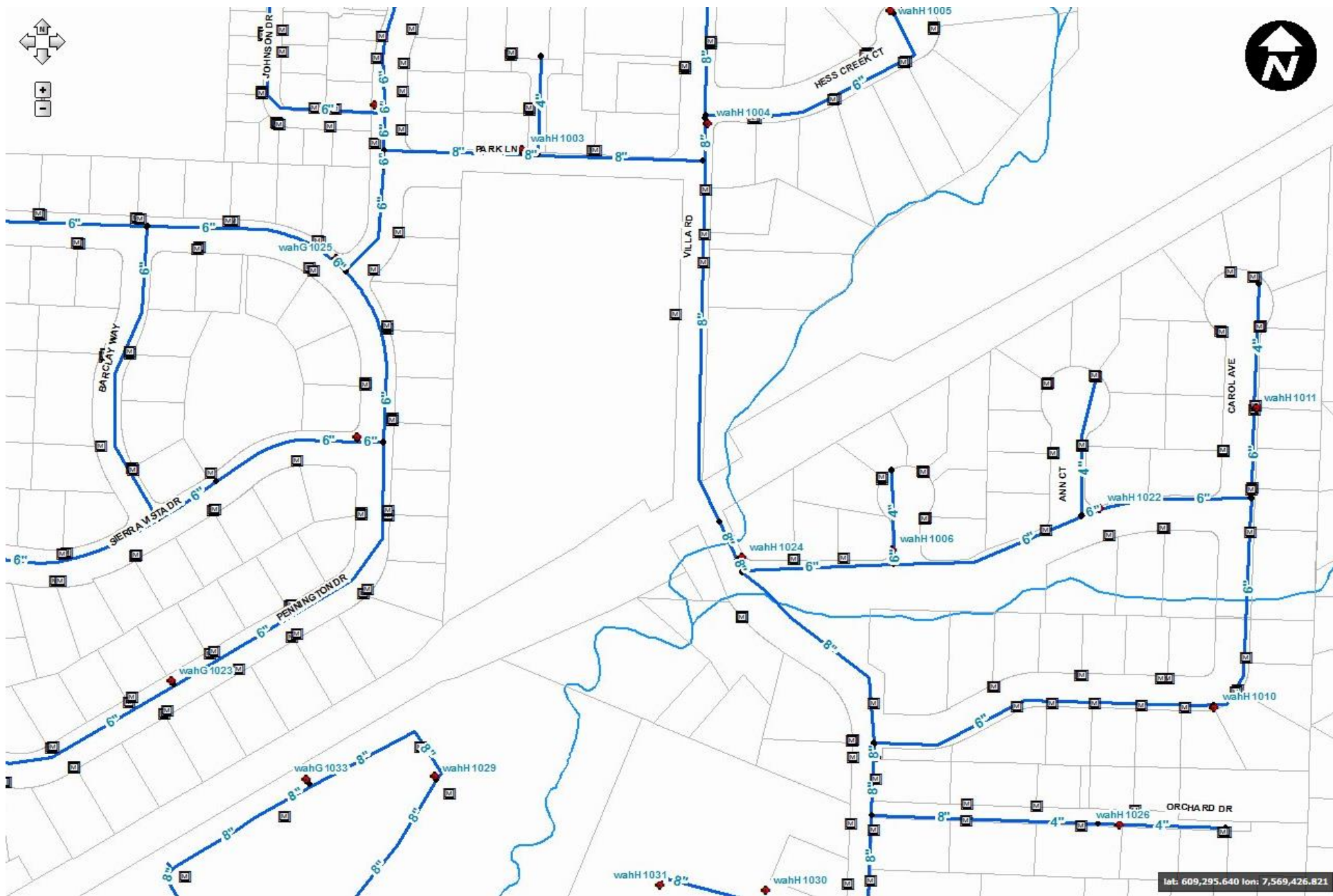







EXHIBIT E: NEIGHBORHOOD MEETING DOCUMENTATION

TUALATIN · VANCOUVER · SALEM

12965 SW HERMAN RD., SUITE 100 · TUALATIN, OR 97062



WWW.AKS-ENG.COM

P: (503) 563-6151 F: (503) 563-6152

December 2, 2014

NEIGHBORHOOD MEETING NOTICE

Ref: 1317 Villa Road
Assessor's Map: R3217BC Tax Lot 00800
Newberg, OR 97132

Dear Interested Party:

AKS Engineering & Forestry, LLC is representing the applicant regarding the property located at 1317 Villa Road. The applicant is proposing a Comprehensive Map Plan Amendment/Zone change and a Site Plan Review for future development of a multi-family housing project. Prior to applying to the City of Newberg we would like the opportunity to discuss the proposal in more detail with the surrounding property owners and residents. You are invited to attend a meeting on:

Tuesday, December 16, 2013 at 6:00 PM
Newberg Christian Church (Classroom 204)
2315 Villa Road
Newberg, OR 97132

Please note that this will be an informational meeting on preliminary plans. These plans may be modified before the application is submitted to the City. You may also receive an official notice from the City of Newberg after the application is accepted, advising you of your opportunity to participate by submitting written comments.

I look forward to discussing this proposal with you. If you have questions, but will be unable to attend, please feel free to call me at 503-563-6151.

Sincerely,
AKS ENGINEERING & FORESTRY, LLC.

A handwritten signature in blue ink that reads 'Mimi Doukas'.

Mimi Doukas, AICP, RLA

3 2 17BC
NEWBERG

3 2 17BC

- CANCELLED NO.
- 600
- 604
- 921
- 1000
- 1017
- 1019
- 1111
- 1115
- 1117
- 1136
- 1141
- 1152
- 1154
- 1157
- 1166
- 1167
- 1169
- 1705
- 1813



THIS MAP WAS PREPARED FOR ASSESSMENT PURPOSE ONLY

SEE MAP 3 18AD

SEE MAP 3 2 17BD

SEE MAP 3 2 17CB

REVISED 3-30-05 BH

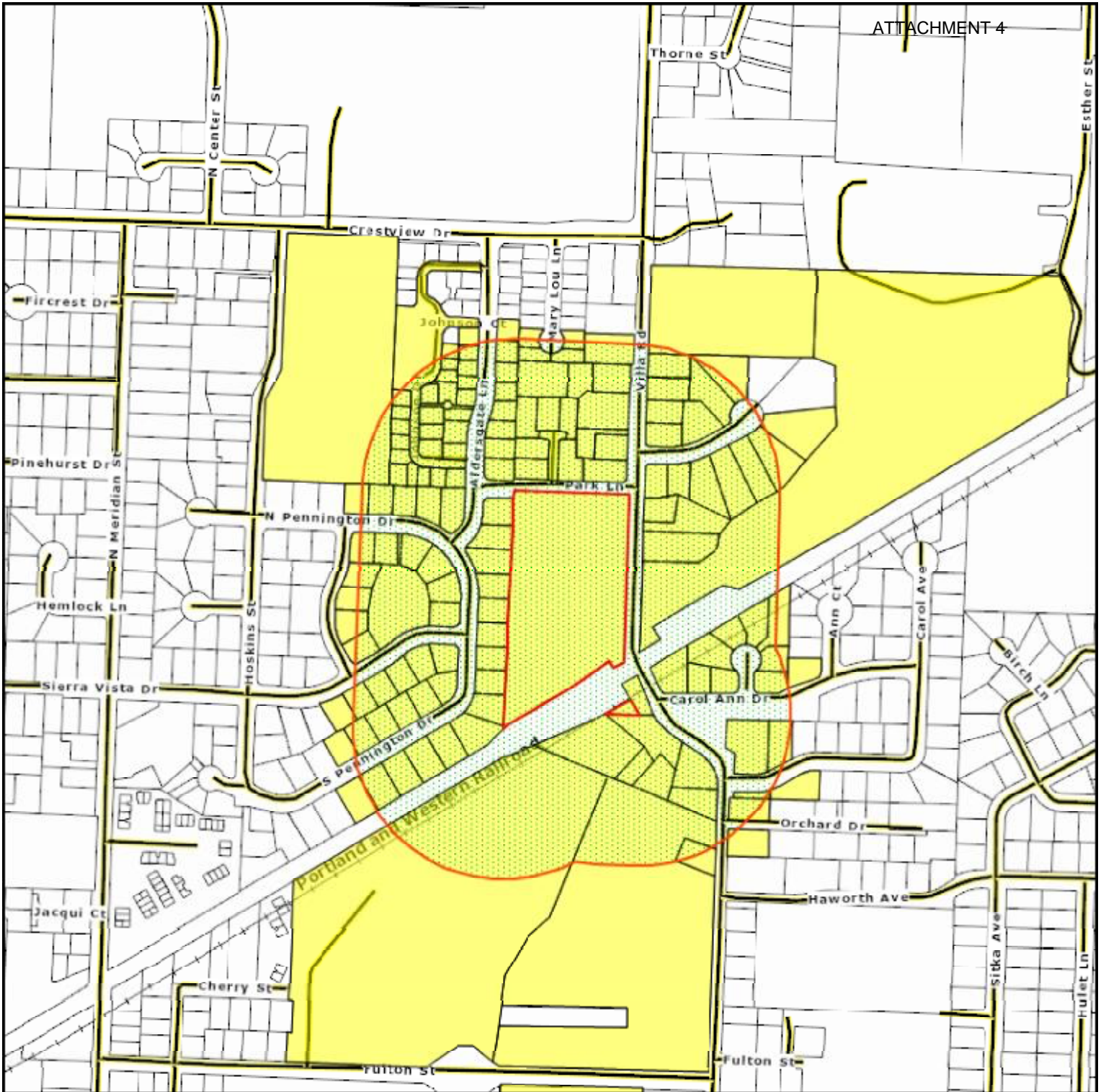

Sentry Dynamics, Inc. and its customers make no representations, warranties or conditions, express or implied, as to the accuracy or completeness of information contained in this report.

geoAdvantage
www.sentrydynamics.net

R3217BC00306
Gouger LLC
9600 NE Glen Hollow Dr
Newberg, OR 97132

R3217BC00309
Gouger LLC
9600 NE Glen Hollow Dr
Newberg, OR 97132

R3217BC00602
James & Lori Harper
1409 Park Ln
Newberg, OR 97132

R3217BC00606
Eulalah Colas
1609 Trestle View Ct
Newberg, OR 97132

R3217BC00609
Gary & Nancy Marugg
276 Royal Oak Street
Newberg, OR 97132

R3217BC00612
Danniel McEuen
1711 Villa Rd
Newberg, OR 97132

R3217BC00800
Martell Family Farm LLC
23480 NE Hyland Dr
Newberg, OR 97132

R3217BC00902
Stephen & Deborah Circo
4609 Sheridan Rd
Oceanside, CA 92056

R3217BC00905
Raymond & Ellen Whited
1225 N Pennington Dr
Newberg, OR 97132

R3217BC00908
Mary & Alan Reid
1216 N Pennington Dr
Newberg, OR 97132

R3217BC00307
Gouger LLC
9600 NE Glen Hollow Dr
Newberg, OR 97132

R3217BC00500
Keith & Mary Gouger
9600 NE Glen Hollow Dr
Newberg, OR 97132

R3217BC00603
Jeremy & Jessica Baker
1401 Park Ln
Newberg, OR 97132

R3217BC00607
Leland & Virginia Parks
1617 Trestle View Ct
Newberg, OR 97132

R3217BC00610
Angela Callender
1709 Villa Rd
Newberg, OR 97132

R3217BC00700
Raymond & Della Grosenbach
1621 Villa Rd
Newberg, OR 97132

R3217BC00900
Public
1209 Sierra Vista Dr
Newberg, OR 97132

R3217BC00903
Harold & Coulliette Hagglund
1217 N Pennington Dr
Newberg, OR 97132

R3217BC00906
Scott & Carol Phoenix
1224 N Pennington Dr
Newberg, OR 97132

R3217BC00909
Nance Drill
1208 N Pennington Dr
Newberg, OR 97132

R3217BC00308
Gouger LLC
9600 NE Glen Hollow Dr
Newberg, OR 97132

R3217BC00601
John & Hope Andrews
1701 Villa Rd
Newberg, OR 97132

R3217BC00605
Lonnie & Barbara Seidel
1301 Park Ln
Newberg, OR 97132

R3217BC00608
John & Lynn Ravelli
1621 Trestle View Ct
Newberg, OR 97132

R3217BC00611
Ruth Olsen
1713 N Villa Rd
Newberg, OR 97132

R3217BC00701
Ezequiel Rodriguez
1613 Villa Rd
Newberg, OR 97132

R3217BC00901
Eric & Julie Black
1504 Aldersgate Ln
Newberg, OR 97132

R3217BC00904
Colleen & Dewain Nummelin
1221 N Pennington Dr
Newberg, OR 97132

R3217BC00907
Barbara Falbey
1220 N Pennington Dr
Newberg, OR 97132

R3217BC00910
Dean & Wendi Denbeck
1204 N Pennington Dr
Newberg, OR 97132

R3217BC00911
Sandra & Paul Prewitt
1408 Barclay Wy
Newberg, OR 97132

R3217BC00914
George & Diana Pike
1304 Barclay Wy
Newberg, OR 97132

R3217BC00934
Kathy White
1201 N Pennington Dr
Newberg, OR 97132

R3217BC00937
Robert & Linda Mead
1213 N Pennington Dr
Newberg, OR 97132

R3217BC01108
Edward Piller
1716 Aldersgate Ln
Newberg, OR

R3217BC01113
Kenneth & Sarah & Kenneth &
Sarah Barber
1620 Aldersgate Ln
Newberg, OR 97132

R3217BC01118
Karen & Carlton Miller
1600 Aldersgate Ln
Newberg, OR 97132

R3217BC01121
Thomas & Ann Boucher
1609 Johnson Dr
Newberg, OR 97132

R3217BC01124
David & Betty Dehaven
1621 Johnson Dr
Newberg, OR 97132

R3217BC01127
Merlin For Lane
16400 NE Herd Rd
Newberg, OR 97132

R3217BC00912
Gerald & Jadene Stensland
901 N Brutscher St D169
Newberg, OR 97132

R3217BC00915
Robert & Mary Kligel
1300 Barclay Wy
Newberg, OR 97132

R3217BC00935
Melvin & Dorothy Haveman
1205 N Pennington Dr
Newberg, OR 97132

R3217BC01101
Oregon Conference Of Free
PO Box 98
Turner, OR 97392

R3217BC01110
Linda Johnson
1708 Aldersgate Ln
Newberg, OR 97132

R3217BC01114
Shirley Cooper
1616 Aldersgate Ln
Newberg, OR 97132

R3217BC01119
Marsha Averett
1601 Johnson Dr
Newberg, OR 97132

R3217BC01122
Phillip & Julie Crouch
1613 Johnson Dr
Newberg, OR 97132

R3217BC01125
Russell & Judith King
1625 Johnson Dr
Newberg, OR 97132

R3217BC01128
Russell Reginald J Estate
1635 Johnson Dr
Newberg, OR 97132

R3217BC00913
Randal & Sheryl Smith
29661 NE Putnam Rd
Newberg, OR 97132

R3217BC00933
David & Joanne Hansen
1113 N Pennington Dr
Newberg, OR 97132

R3217BC00936
Lewis & Johanne Scott
1209 N Pennington Dr
Newberg, OR 97132

R3217BC01106
Alan & Molly Schneider
1800 Aldersgate Ln
Newberg, OR 97132

R3217BC01112
E Lamar & Jeanette Aldridge
1700 Aldersgate Ln
Newberg, OR 97132

R3217BC01116
John & Rose Moffitt
512 Buckley Ln
Newberg, OR 97132

R3217BC01120
William & Kathleen Litherland
1605 Johnson Dr
Newberg, OR 97132

R3217BC01123
Nora E For Williams
1617 Johnson Dr
Newberg, OR 97132

R3217BC01126
Irma For & Irma Cristofor
1629 Johnson Dr
Newberg, OR 97132

R3217BC01129
Oregon Conference Of Free
PO Box 98
Turner, OR 97392

R3217BC01145 Ruth Cole 1204 Johnson Ct Newberg, OR 97132	R3217BC01146 Patricia G For & Patricia Harris 1715 Aldersgate Ln Newberg, OR 97132	R3217BC01147 Nancy & James & Nancy Obrien 1709 Aldersgate Ln Newberg, OR 97132
R3217BC01148 Rosalyn M For Gregory 1705 Aldersgate Ln Newberg, OR 97132	R3217BC01149 Margaret Palmer 1701 Aldersgate Ln Newberg, OR 97132	R3217BC01150 Sheri Address 1619 Aldersgate Ln Newberg, OR 97132
R3217BC01151 Merle & Doris Brandt 1609 Aldersgate Ln Newberg, OR 97132	R3217BC01153 Jennifer L For & Jennifer Meyers 1600 Johnson Dr Newberg, OR 97132	R3217BC01155 Donna Michael 1616 Johnson Dr Newberg, OR 97132
R3217BC01156 Frances For & Frances Braun 1624 Johnson Dr Newberg, OR 97132	R3217BC01158 Darlene & Kenneth R Of & Darlene & Kenneth Sutton 1630 Johnson Dr Newberg, OR 97132	R3217BC01159 Robert & Sue Bletscher 16390 SE Hillside Ln Milwaukie, OR 97267
R3217BC01160 Robert & Sue Bletscher 16390 SE Hillside Ln Milwaukie, OR 97267	R3217BC01161 Judith McCartney 55 Cactus Dr Sedona, AZ 86336	R3217BC01162 Ephraim & Mary Schwab 17600 NE Aviation Way Newberg, OR 97132
R3217BC01163 Janie Berry 1716 Johnson Dr Newberg, OR 97132	R3217BD00100 Hazelden Springbrook Inc PO Box 11 Center City, MN 55012	R3217BD00200 Joyful Servant Lutheran Church 1716 Villa Rd Newberg, OR 97132
R3217BD00300 Scott & Diane Allen 1708 Villa Rd Newberg, OR 97132	R3217BD00400 Mark & Lynette Okazaki 1704 Villa Rd Newberg, OR 97132	R3217BD00500 Michael & Lazanne Speelman 1700 Villa Road Newberg, OR 97132
R3217BD00600 Paul Blattner Jr 1501 Hess Creek Ct Newberg, OR 97132	R3217BD00700 Steven & Jeannia Muhr 1511 Hess Creek Ct Newberg, OR 97132	R3217BD00800 Katherine & Katherine Tri 1517 Hess Creek Ct Newberg, OR 97132
R3217BD00900 Donald & Sherry Sylvester 1521 Hess Creek Ct Newberg, OR 97132	R3217BD01200 Julie Isaacson 1524 Hess Creek Ct Newberg, OR 97132	R3217BD01300 Jeannine Graham 1520 Hess Creek Ct Newberg, OR 97132
R3217BD01400 Estela Oropeza 1516 Hess Creek Ct Newberg, OR 97132	R3217BD01500 Kevin & Krista Sellars 1512 Hess Creek Ct Newberg, OR 97132	R3217BD01600 Elbert & Atina Buck 1508 Hess Creek Ct Newberg, OR 97132

R3217BD01700
Ronald & Gwen Johns
1504 Hess Creek Ct
Newberg, OR 97132

R3217BD01901
Jenny Vincent
1600 Villa Rd
Newberg, OR 97132

R3217BD02001
Douglas & Pauline Wilkinson
1705 Carol Ann Dr
Newberg, OR 97132

R3217BD02004
Rene Strong
1715 Elderberry Ct
Newberg, OR 97132

R3217BD02008
Brian & Hendrea Ferguson
1805 Elderberry Ct
Newberg, OR 97132

R3217CA00100
Alma & Cecil Loggains
1300 Villa Rd
Newberg, OR 97132

R3217CA00115
Sara Grant
1214 Villa Rd
Newberg, OR 97132

R3217CA02700
Gary & Shirley Eckerdt
1219 Villa Rd
Newberg, OR 97132

R3217CA02704
James & Connie Remfert
1309 Villa Rd
Newberg, OR 97132

R3217CA02800
George Fox University
414 N Meridian St
Newberg, OR 97132

R3217BD01800
Glen Taylor
1500 Hess Creek Ct
Newberg, OR 97132

R3217BD01902
Mark Reynolds
1500 N Villa Rd
Newberg, OR 97132

R3217BD02002
Michael & Margaret Allen
1709 Elderberry Ct
Newberg, OR 97132

R3217BD02005
Joseph & Marita G For & Joseph &
Marita Brugato
1720 Elderberry Ct
Newberg, OR 97132

R3217BD02009
Jackie Fowler
1726 Elderberry Ct
Newberg, OR 97132

R3217CA00101
Steven & Rachel Sletten
135 Veronica Ave
Sparks, NV 89436

R3217CA00200
Sara Grant
1214 Villa Rd
Newberg, OR 97132

R3217CA02701
Kelly & Carla Wilson
4072 Collier Ln
Klamath Falls, OR 97603

R3217CA02705
Jack & Carla Rich
1303 Villa Rd
Newberg, OR 97132

R3217CA03002
George Fox University
414 N Meridian St
Newberg, OR 97132

R3217BD01900
Mary Tack
1400 Villa Rd
Newberg, OR 97132

R3217BD02000
Steven Goodwin Sr
1701 Carol Ann Dr
Newberg, OR 97132

R3217BD02003
Samuel & Brianna Provoast
1713 Elderberry Ct
Newberg, OR 97132

R3217BD02006
John & Sharon Johnson
1724 Elderberry Ct
Newberg, OR 97132

R3217BD02123
Meredith Roybal
1813 Ann Ct
Newberg, OR 97132

R3217CA00114
Keith & Linda Hansen
1808 Carol Ave
Newberg, OR 97132

R3217CA00900
Keith Hansen
1808 Carol Ave
Newberg, OR 97132

R3217CA02702
Tim Labeck
670 NE 18th St
Hillsboro, OR 97124

R3217CA02706
Ernest & Barbara For Meyer
3801 E Hayes St No 231
Newberg, OR 97132

R3217CB00100
Lindsey Levanen
21726 Placerita Canyon Rd
Santa Clarita, CA

R3217CB00101
Brandt Thissell
1230 S Pennington Dr
Newberg, OR97132

R3217CB00104
Doreen App
1218 S Pennington Dr
Newberg, OR 97132

R3217CB00107
Rebecca Bertagna
PO Box 308
Newberg, OR 97132

R3217CB00117
Donald Bjurstrom
1119 S Pennington Dr
Newberg, OR 97132

R3217CB00120
Rick & Jill Dorrell
1211 S Pennington Dr
Newberg, OR 97132

R3217CB00123
Rayola Branson
1216 Sierra Vista Dr
Newberg, OR 97132

R3217CB00126
Robert & Shirley Francis
1204 Sierra Vista Dr
Newberg, OR 97132

R3217CB00200
Friendsview Manor
1301 Fulton St
Newberg, OR 97132

R3217CB00102
Darrell Sample
1226 S Pennington Dr
Newberg, OR97132

R3217CB00105
Mary Schwinkendorf
1958 Gable Ct NE
Salem, OR 97303

R3217CB00108
Bret & Serena Martin
23520 NE Hyland Dr
Newberg, OR 97132

R3217CB00118
Robert & Donna Young
1203 S Pennington Dr
Newberg, OR 97132

R3217CB00121
Stephen Rhine
1215 S Pennington Dr
Newberg, OR 97132

R3217CB00124
Wesley & Noelle Marie Torres
1212 Sierra Vista Dr
Newberg, OR 97132

R3217CB00127
David & Sharon Eklund
1200 Sierra Vista Dr
Newberg, OR 97132

R3217CB00103
Torivio & Beverly Rosalez
311 W Edgewood Dr
Newberg, OR97132

R3217CB00106
Timothy & Pamela Weaver
159 NW Viewmont Dr
Dundee, OR 97115

R3217CB00109
Christopher Niehus
PO Box 340
St Paul, OR 97137

R3217CB00119
Dawn Morales
1207 S Pennington Dr
Newberg, OR 97132

R3217CB00122
Christopher & Caprice Grage
1223 S Pennington Dr
Newberg, OR 97132

R3217CB00125
William & Joann Myers
1208 Sierra Vista Dr
Newberg, OR 97132

R3217CB00128
James & Katherine Simmons
1112 Sierra Vista Dr
Newberg, OR 97132

1317 Villa Road
 December 16, 2014
 6:00 p.m.

Newberg Christian Church
 2315 Villa Road
 Newberg, OR 97132

NAME PLEASE PRINT CLEARLY
 STREET ADDRESS
 PHONE/EMAIL

- | | |
|--|--|
| <p>1. Ron & Gwen Johns
 1504 Hess Creek Ct
 Newberg 503-538-3960 <i>CRRon@aol.com</i></p> <p>2. Bob & Linda Ruckert
 709 SW Viewmont
 Dundee, OR 97115</p> <p>3. Raymond White
 1225 N. Pennington Dr
 503 538 6000</p> <p>4. Kathy & Nick Tri
 1517 Hess Creek Ct
 Newberg OR 97132</p> <p>5. Barbara Falbey <i>barbarafalbey@aol.com</i>
 1220 N Pennington Dr
 Newberg 503-538-2139</p> <p>6. Julia Fuzell
 1435 Johnson Dr
 503-537-9772 97132</p> <p>7. Jean Baum
 1624 Johnson Dr
 97132</p> | <p>8. Sara Grant
 1214 Villa Rd</p> <p>9. Mike & Margaret Allen
 1709 Elderberry Ct.
 503-538-7167</p> <p>10. Janny & Malcolm Vuksich
 1600 Villa Rd
 503 719 3897</p> <p>11. Gary & Shirley Eckardt
 1219 Villa Rd
 Newberg OR 97132</p> <p>12. Harold Hagglund
 1217 N Pennington Dr
 503-307-7418 <i>Harold@ConsultHH.co</i></p> <p>13. Jessica Baker
 1401 Park Ln
 Newberg</p> <p>14. Eric Black
 1504 Aldersgate Ln
 JACK M GARRAUGH
 1404 HOSKINS</p> |
|--|--|

TUALATIN · VANCOUVER · SALEM



WWW.AKS-ENG.COM

12965 SW HERMAN RD., SUITE 100 · TUALATIN, OR 97062

P: (503) 563-6151 F: (503) 563-6152

1317 Villa Road
December 16, 2014
6:00 p.m.

Newberg Christian Church
2315 Villa Road
Newberg, OR 97132

NAME

PLEASE PRINT CLEARLY

STREET ADDRESS

PHONE/EMAIL

- | | | | |
|-----|--|-----|--|
| 15. | <u>George Cutts</u>
<u>5800 Meadows Rd #100</u>
<u>Lake Oswego, OR 97035</u> | 22. | <u>Rob Molzahn</u>
<u>2501 Portland Rd</u>
<u>Newberg OR 97132</u> |
| 16. | <u>Paul Blattner</u>
<u>1501 Hess Creek Court</u>
<u>Newberg OR 97132</u> | 23. | <u>Dave Dettaren</u>
<u>1621 Johnson Dr.</u>
<u>Newberg, OR 97132</u> |
| 17. | <u>JENNIFER MEJERS</u>
<u>1600 JOHNSON DR</u>
<u>NEW BERG, OR 97132</u> | 24. | <u>Bill & Ruth Schrempp</u>
<u>1713 Villa Rd</u>
<u>Newberg, OR 97132</u> |
| 18. | <u>Mary Ann Ack</u>
<u>1700 Villa Rd</u>
<u>Newberg OR 97132</u> | 25. | <u>Charles Gysin / Angel Callender</u>
<u>1709 Villa Rd.</u>
<u>Newberg 97132</u> |
| 19. | <u>Deward Nommelin</u>
<u>1221 N. Pennington Dr</u>
<u>Newberg Or 97132</u> | 26. | <u>Glen & Connie Taylor</u>
<u>1500 Hess Creek Ct</u>
<u>Newberg, OR 97132</u> |
| 20. | <u>Sandra Prewitt</u>
<u>1408 Barclay Way</u>
<u>Newberg OR 97132</u> | 27. | <u>N. Stone</u>
<u>1208 N Pennington Dr</u>
<u>Newberg OR 97132</u> |
| 21. | <u>Christina Crawford</u>
<u>1400 Villa Rd.</u>
<u>Newberg OR 97132</u> | 28. | <u>Island & Virginia Parks</u>
<u>1619 Trestle View Ct</u>
<u>Newberg OR 97132</u> |



1317 Villa Road
 December 16, 2014
 6:00 p.m.

Newberg Christian Church
 2315 Villa Road
 Newberg, OR 97132

NAME
 STREET ADDRESS
 PHONE/EMAIL

PLEASE PRINT CLEARLY

29. Brian & Beth Keyser
 1400 Hoskins St. Newberg
 503.730.2599 bkeyser777@frontier.com

30. CLAUDE HAMPTON
 1400 BARRELLAY WAY
 503-680-8818 CLAUDEHampt@AOL.com

31. Lewis & Johanne Scott
 1209 N. Pennington Dr.
 (503) 530-9870 johannescott51@comcast.net

32. Lon & BARBARA Seidel
 1307 PARK LN
 541-513-8939 cleantanksoffrontier.com

33. BRANDT THISSELL
 1230 S. PENNINGTON DR
 541-270-4838 brandtthissell@gmail.com

34. Doug Martell
 28480 NE Highland Dr
 Newberg OR 97132

35. _____

36. Connie Polis Taylor
 1500 Hess Creek Ct.
 Newberg, Ore.

37. Allan Martell
 29955 NE Benjamin Rd
 Newberg, OR 97132

38. _____

39. _____

40. _____

41. _____

42. _____

December 17, 2014

Neighborhood Meeting Summary: 1317 Villa Road
 Assessor's Map: R3217BC Tax Lot 00800
 Newberg, Oregon 97132

Meeting Date: December 16, 2014

Time: 6:00 PM

Location: Newberg Christian Church, 2315 Villa Road, Newberg OR 97132

The following serves as a summary of the primary subjects covered at the Neighborhood Meeting. Mimi Doukas from AKS Engineering & Forestry, Jeff Curran and Darren Welborn of DJ2 Holdings, and Michael Parshall of Western Design Group were present. A brief presentation about the project was made, followed by questions and answers. Business cards with contact information and an attendance sheet to sign was circulated.

Major topics of discussion:

- Comprehensive Map Amendment and Zone Change for multi-family housing
- Processed through City staff for Planning Commission review and recommendation to City Council
- Preliminary design includes 16 buildings, 144 units and 208 parking spaces
- One, two and three bedroom apartments, ranging from approx. 580 to 1,000 square feet
- Two and three story staggered buildings with centralized facilities and parking
- Project will be served by existing public utilities, water, sanitary sewer, and storm sewer
- On-site stormwater management, with pond design and fencing
- Community center and outdoor public spaces with picnic tables and barbeques
- Public street improvements, with sidewalks along Park Lane and Villa Road
- One access on Park Lane, one on Villa road and an emergency vehicle access
- Project to meet the housing needs of Newberg area, including that of college students
- Market rate rentals for the Newberg area with quality construction and desire to increase property values of adjacent homes
- Discussion about other projects developed, owned, or managed by this group
- Desire for buffer for privacy along west side of project and adjacent homes
- Desire for mature landscaping along street frontage to ease visual impact of large buildings
- Desire for street, pedestrian, and bicycle lane improvements along Villa
- Concerns were raised about increased traffic, sight distance for left hand turns, access in and out of the project and adjacent neighbor driveways
- Concern about construction traffic, parking, and hours of operation during building phase
- Discussion about grading of project and existing retaining walls on adjacent properties
- Concerns about erosion control during construction and drainage of water to off-site locations
- Discussion about construction timeline from permitting through building completion
- City process for the application, review, hearing and approval

Sincerely,

AKS ENGINEERING & FORESTRY, LLC



Mimi Doukas, AICP, RLA



EXHIBIT F: TRAFFIC IMPACT ANALYSIS

Transportation Impact Analysis

Martell Commons Site Rezone and Development

Newberg, Oregon

February 2015

Transportation Impact Analysis

Martell Commons Site Rezone and Development

Newberg, Oregon

Prepared For:
DJ2 Holdings, LLC
13805 SE Aldridge Road
Happy Valley, Oregon 97086

Prepared By:
Kittelson & Associates, Inc.
610 SW Alder, Suite 700
Portland, OR 97205
(503) 228-5230

Project Manager: Patrick Marnell, E.I.T.
Project Principal: Brian J. Dunn, P.E.

Project No. 18152

February 2015



TABLE OF CONTENTS

Executive Summary 2

Introduction 6

 Scope Of The Report..... 6

Existing Conditions 10

 Site Conditions and Adjacent Land Uses 10

 Project Description 10

 Transportation Facilities 10

 Traffic Volumes And Peak Hour Operations 11

Transportation Impact Analysis 16

 Year 2016 Background Traffic Conditions 16

 Proposed Development Plan 17

 Year 2016 Total Traffic Conditions 20

 Year 2035 Background Traffic Conditions 23

 Year 2035 Total Traffic Conditions 23

Transportation Planning Rule Compliance 30

On-Site Circulation/Site-Access Operations 32

Conclusions and Recommendations 35

References 39

LIST OF FIGURES

Figure 1: Site Vicinity Map 7

Figure 2: Proposed Site Development Plan 8

Figure 3: Existing Lane Configurations and Traffic Control Devices 12

Figure 4: Existing Traffic Conditions, Weekday AM and PM Peak Hours 13

Figure 5: Year 2016 Background Traffic Conditions, Weekday AM and PM Peak Hours 18

Figure 6: Proposed Lane Configuration and Traffic Control Devices 19

Figure 7: Year 2016 Trip Generation and Distribution, Weekday AM and PM Peak Hours 21

Figure 8: Year 2016 Total Traffic Conditions, Weekday AM and PM Peak Hours 22

Figure 9: Year 2035 Background Traffic Conditions, Weekday PM Peak Hour 24

Figure 10: Estimated Year 2035 Site-Generated Traffic Volumes, Weekday PM Peak Hour 26

Figure 11: Year 2035 Total Traffic Conditions, Weekday PM Peak Hour 27

Figure 12: Horizontal Intersection Sight Distance Along Villa Road 33

LIST OF TABLES

Table 1 Existing Transportation Facilities 10

Table 2 Intersection Crash Summary (2009-20013) 16

Table 3 Estimated Martell Commons Trip Generation 22

Table 4 Reasonable Worst Case Trip Generation Scenarios 28

APPENDICES

- Appendix A Traffic Count Data
- Appendix B Description of Level-of-Service Methods and Criteria
- Appendix C Existing Conditions Level-of-Service Worksheets
- Appendix D Crash Data
- Appendix E Year 2016 Background Traffic Level-of-Service Worksheets
- Appendix F Year 2016 Total Traffic Level-of-Service Worksheets
- Appendix G Year 2035 Background Traffic Level-of-Service Worksheets
- Appendix H Year 2035 Total Traffic Level-of-Service Worksheets
- Appendix I Year 2035 Total Traffic Level-of-Service Worksheets - Mitigated

Section 1 Executive Summary

EXECUTIVE SUMMARY

DJ2 Holdings, LLC is proposing to develop the Martell Commons apartment complex in Newberg, Oregon. The proposed development site is located along the west side of Villa Road, south of Park Lane. It is approximately 5.94 acres in size and is currently zoned for R-1 Low Density Residential. The site is proposed to be rezoned to R-3 High Density Residential, which would theoretically allow for up to 168 apartment units. Upon approval of the proposed zone change, construction of the 128-unit Martell Commons is expected to commence in this year 2015, with an anticipated build-out year of 2016.

The results of this traffic impact analysis report indicate that with recommended mitigation measures in place, the proposed site rezone will comply with the State's Transportation Planning Rule by not materially degrading the long-term operations of existing and planned transportation network. In addition, this report demonstrates that the construction of the Martell Commons apartment complex can be achieved while maintaining acceptable levels of service and safety on the surrounding transportation system for the build-out year, with recommended mitigation measures in place. The findings of this analysis and our recommendations are summarized below.

Existing Conditions

- All of the study intersections currently operate at acceptable levels of service during the weekday a.m. and p.m. peak hours.
- A review of crash history did not reveal any patterns at study intersections that require mitigation associated with this project.

Year 2016 Background Traffic Conditions

- All of the study intersections are forecast to continue meeting operational standards during the weekday a.m. peak hour.
- All of the study intersections, except the Villa Road/OR 99W intersection, are forecast to continue meeting operational standards during the weekday p.m. peak hour.
 - The Villa Road/OR 99W intersection is forecast to operate with a v/c ratio of 0.88 in the p.m. peak hour which exceeds the ODOT mobility standard of 0.85.

Proposed Development Plan

- The actual proposed site development for the Martell Commons complex will consist of up to 128 apartment units. This is estimated to conservatively generate 899 average daily trips, 66 trips (13 inbound, 53 outbound) during the weekday a.m. peak hour, and 88 trips (57 inbound, 31 outbound) during the weekday p.m. peak hour.

Year 2016 Total Traffic Conditions

- All of the study intersections, including the proposed site access to Villa Road, are forecast to meet operational standards during the weekday a.m. peak hour.
- All of the study intersections, except the Villa Road/OR 99W intersection, are forecast to meet operational standards during the weekday p.m. peak hour.
 - As under background traffic conditions, the Villa Road/OR 99W intersection is forecast to continue to operate with a v/c ratio of 0.88 during the p.m. peak hour which exceeds the ODOT standard of 0.85.

Year 2035 Background Traffic Conditions

- All of the study intersections except the Villa Road/OR 99W intersection and Villa Road/Fulton Street intersection are forecast to meet operational standards during the weekday p.m. peak hour.
 - The Villa Road/OR 99W intersection is forecast to operate with a v/c ratio of 1.11 which exceeds the ODOT standard of 0.85.
 - The Villa Road/Fulton Street intersection is forecast to operate with a LOS F which exceeds the City's standard of LOS D or better.

Year 2035 Total Traffic Conditions

- With no off-site mitigation measures, all of the study intersections except the Villa Road/OR 99W intersection and Villa Road/Fulton Street intersection are forecast to continue meeting operational standards during the weekday p.m. peak hour.
 - The Villa Road/OR 99W intersection is forecast to operate with a v/c ratio of 1.12 which is an increase of 0.01 from background conditions and exceeds the ODOT standard of 0.85.
 - The Villa Road/Fulton Street intersection is forecast to continue operating at LOS F which exceeds the City's standard of LOS D or better.

Mitigation Measures

- The proposed Martell Commons development will provide multimodal improvements along Villa Road by adding pedestrian facilities and bicycle lanes on one or both sides of the roadway along the site frontage. Additionally, through additional coordination efforts, the developer desires to connect the sidewalk facilities along the site frontage to an existing pedestrian path to complete a continuous pedestrian/bicycle link between the development site and George Fox University to the south. These multimodal improvements are sufficient

to mitigate the minor increase in v/c ratio generated by the development at the Villa Road/OR 99W intersection.

- The Villa Road/Fulton Street intersection should be modified to all-way stop control. This would allow the intersection to operate at LOS E, representing an improvement over year 2035 background conditions without the site development.

On-Site Circulation/Site Access Operations

- All of the proposed external site access points at Park Lane and to Villa Road will function acceptably with stop control on the minor driveway approaches.
- The vertical and horizontal alignments of the proposed full-street improvements along the Villa Road site frontage should be designed to provide adequate intersection sight distance from the proposed site access driveway.
- Shrubbery and landscaping near the site access points should be maintained to ensure adequate intersection sight distance at both site driveways to Villa Road and Park Lane.

Section 2 Introduction

INTRODUCTION

DJ2 Holdings, LLC is proposing to development an apartment complex (Martell Commons) in Newberg, Oregon. The proposed development site is located along the west side of Villa Road, south of Park Lane. It is approximately 5.94 acres in size and is currently zoned for R-1 Low Density Residential. The site is proposed to be rezoned to R-3 High Density Residential, which would theoretically allow for up to 168 apartment units. Upon approval of the proposed zone change, construction of the 128-unit Martell Commons is expected to commence in this year 2015, with an anticipated build-out year of 2016. A site vicinity map is shown in Figure 1, and the proposed site development plan is shown in Figure 2.

SCOPE OF THE REPORT

This analysis determines the transportation-related impacts associated with the proposed rezone and development plan for the Martell Commons apartment complex and was prepared in accordance with the City of Newberg and Oregon Department of Transportation (ODOT) transportation standards. The study intersections and scope of this project were determined through a coordinated scoping effort with City staff. Operational analyses were performed at the following study intersections:

- Aldersgate Lane/Crestview Drive;
- Aldersgate Lane/Park Lane;
- Villa Road/Park Lane;
- Villa Road/Fulton Street;
- Villa Road/OR 99W; and,
- Villa Road/proposed site access.

This report evaluates the following transportation issues to address the requirements of the State's Transportation Planning Rule for the proposed zone change and the requirements of the City of Newberg for the proposed site development plan:

- Existing land-use and transportation-system conditions within the site vicinity during the weekday a.m. and p.m. peak hour periods;
- Forecast year 2016 background traffic conditions during the weekday a.m. and p.m. peak hours;
- Trip generation and distribution estimates for the proposed Martell Commons apartment site development;
- Forecast year 2016 total traffic conditions during the weekday a.m. and p.m. peak hours with build-out of the site;
- Forecast year 2035 background traffic conditions during the weekday p.m. peak hour;
- Forecast year 2035 total traffic conditions during the weekday p.m. peak hour with a maximum build-out scenario for the site; and
- Compliance with the State's Transportation Planning Rule.



(NO SCALE)

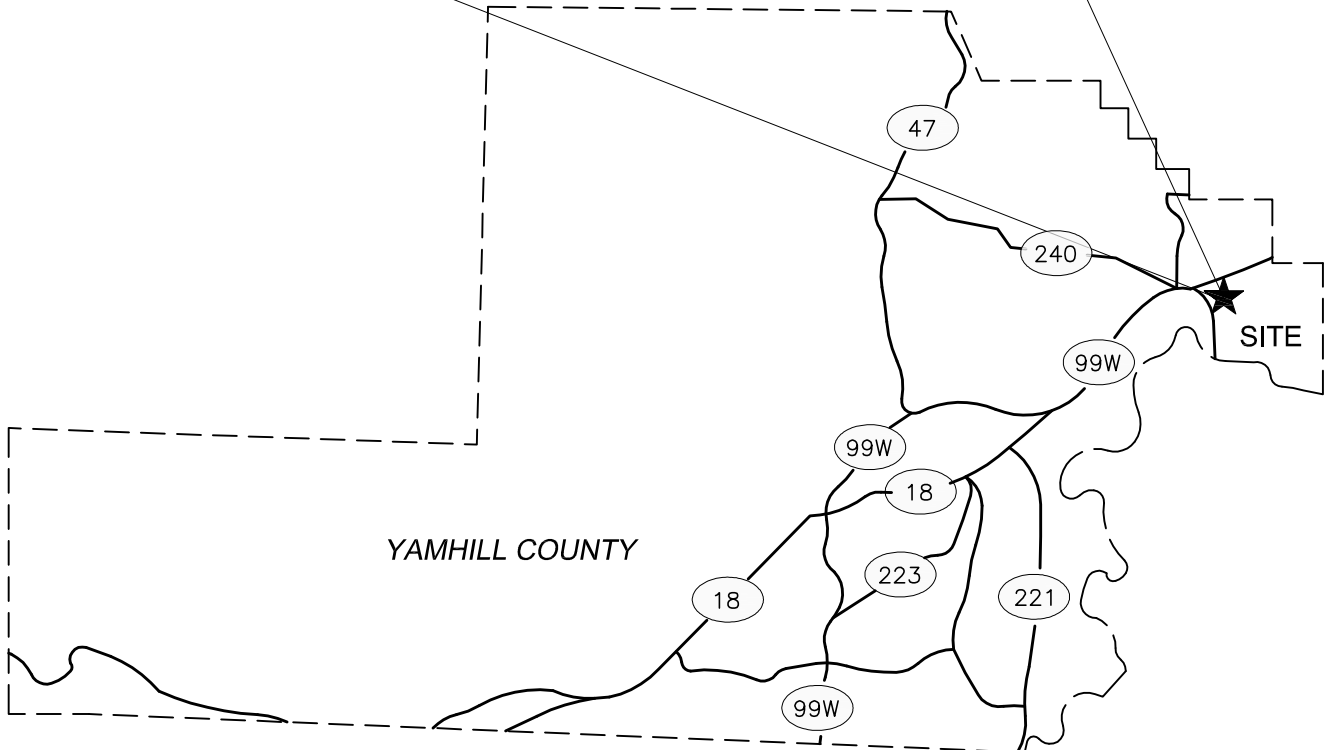
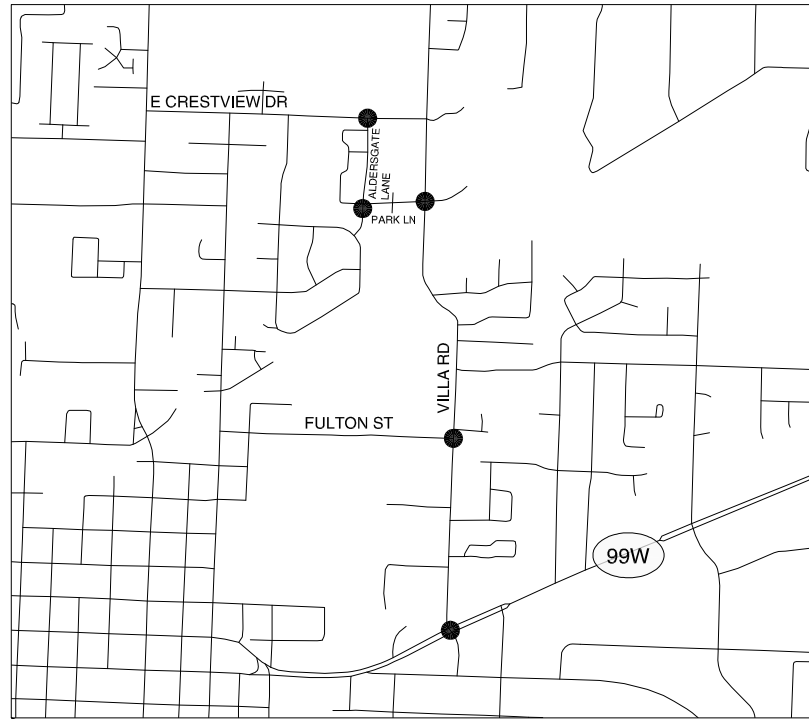

LEGEND

- - STUDY INTERSECTION

SITE VICINITY MAP
NEWBERG, OREGON

FIGURE
1

H:\profile\18152 - Villa Road Apartments\dwgs\18152_figs.dwg Feb 13, 2015 - 4:55pm - pmarnell Layout Tab: 01

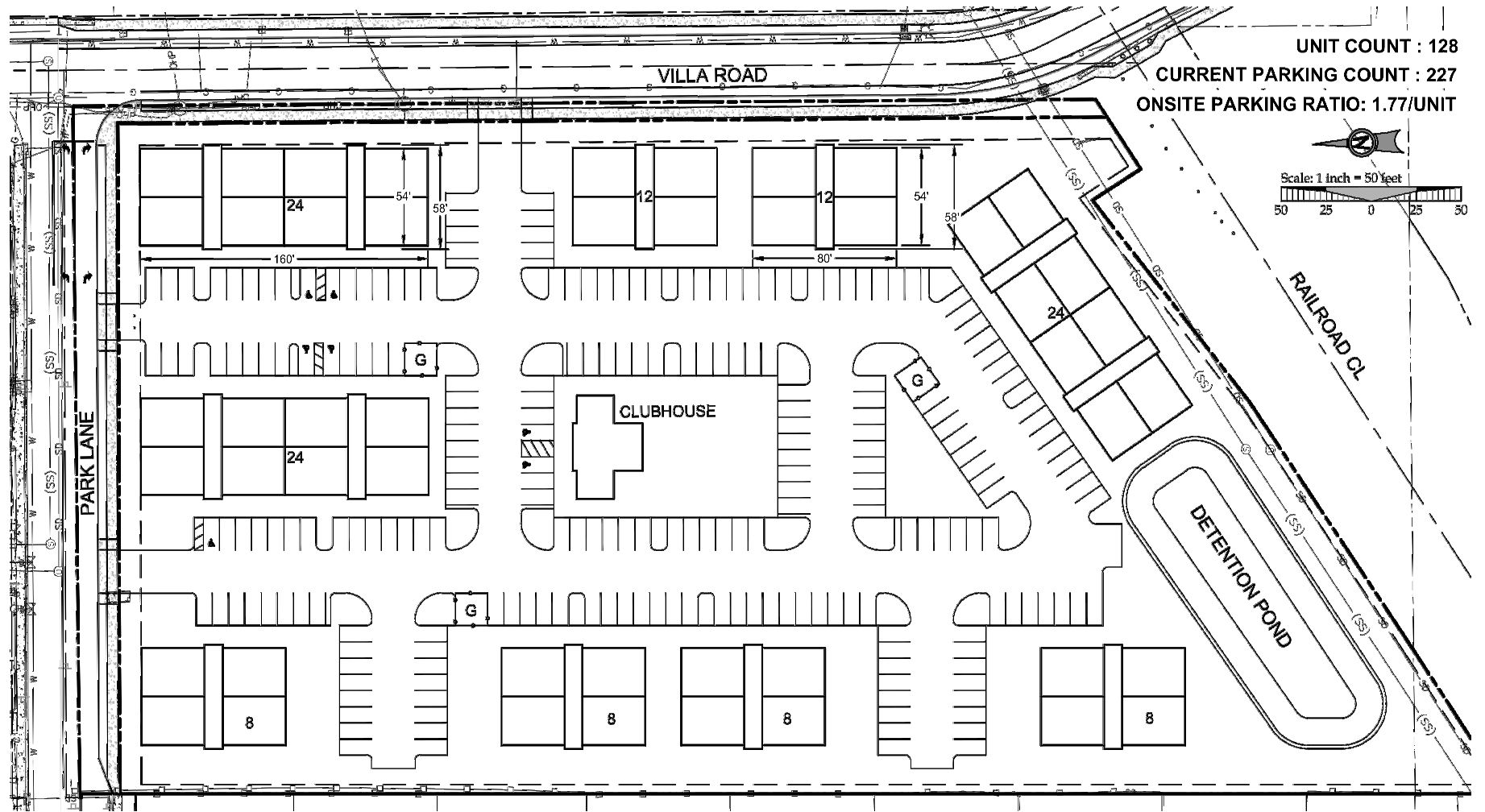

UNIT COUNT : 128
 CURRENT PARKING COUNT : 227
 ONSITE PARKING RATIO: 1.77/UNIT

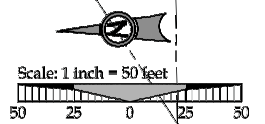

SITE PLAN PROVIDED BY 3J
 CONSOLTING INC: JAN. 2015

PRELIMINARY SITE PLAN
 NEWBERG, OREGON

FIGURE
2

H:\profile\18152 - Villa Road Apartments\dwg\18152_figs.dwg Feb 06, 2015 - 8:02am - pmarnell Layout Tab: 02

Section 3 Existing Conditions

EXISTING CONDITIONS

The existing conditions analysis identifies the site conditions and current operational and geometric characteristics of the roadways within the study area. These conditions will be compared with future conditions later in this report.

Kittelson & Associates, Inc. (KAI) staff visited and inventoried the proposed Martell Commons development site and surrounding study area in September 2014. At that time, KAI collected information regarding site conditions, adjacent land uses, existing traffic operations, and transportation facilities in the study area.

SITE CONDITIONS AND ADJACENT LAND USES

The proposed site is located within the City of Newberg limits, is currently vacant, and is zoned for R-1 Low Density Residential. The site is bounded on the north by Park Lane, on the east by Villa Road, on the south by a Portland & Western Railroad line, and to the west by single family homes and Aldersgate Lane. The land uses in the vicinity of the site are primarily residential homes. Additionally, George Fox University is located approximately ½ mile south of the proposed site.

PROJECT DESCRIPTION

DJ2 Holdings, LLC is proposing to rezone the development site to R-3 High Density Residential, which would allow for a maximum of 168 apartment units. Once the rezone is complete, the DJ2 Holdings, LLC intends to build the Martell Commons apartment complex, which will only have up to 128 units. Access to the site will be provided by a driveway to Villa Road and two driveways to Park Lane. Construction of this residential development is expected to begin in the 2015 and the anticipated build-out year is 2016.

TRANSPORTATION FACILITIES

Table 1: Existing Transportation Facilities

Roadway	Functional Classification ¹	Number of Lanes	Speed Limit (mph)	Sidewalks	Bicycle Lanes	On-Street Parking Allowed?
Aldersgate Lane	Local/Residential	2	25 (Not Posted)	Yes	No	Yes
Crestview Drive	Minor Collector	2	25	Partial	Sharrow	In Areas
Park Lane	Local/Residential	2	25 (Not Posted)	North Side Only	No	Yes
Villa Road	Major Collector	2	25	Partial	Partial Bicycle Lanes & Sharrow	No
Fulton Street	Major Collector	2/3	25	Yes	Sharrow	No
OR 99W	Major Arterial/ Statewide Highway	6	35	Yes	Yes	No

¹ Per City of Newberg Transportation System Plan Update (Reference 1)

Figure 3 displays the existing lane configurations and traffic control devices at the identified existing study intersections.

Pedestrian and Bicycle Facilities

Bicycles are currently accommodated in the study area with the use of bicycle lanes or sharrows on OR 99W, Villa Road, Crestview Drive, and Fulton Street. The pedestrian and bicycle network in the immediate vicinity of the site (i.e. Villa Road) is largely incomplete. To the south, no continuous pedestrian route currently exists between the proposed development site and George Fox University or OR 99W.

Transit Facilities

Local transit service is not provided in the vicinity of the proposed site. Yamhill County Transit operates bus routes along OR 99W approximately $\frac{3}{4}$ mile south of the proposed site, and along College Street approximately $\frac{1}{2}$ mile from proposed site.

TRAFFIC VOLUMES AND PEAK HOUR OPERATIONS

In September 2014, manual turning-movement counts were obtained for the all the existing study intersection. All the counts used in this analysis were conducted on a typical mid-week day, while George Fox University was in session, during the morning (7:00 to 9:00 a.m.) and evening (4:00 to 6:00 p.m.) peak time periods. The system-wide morning and evening peak hours were found to occur between 7:05 a.m. and 8:05 a.m. and 5:00 p.m. and 6:00 p.m., respectively. Figure 4 provides a summary of the existing traffic volumes at all study intersections for the weekday a.m. and p.m. peak hours. *Appendix "A" contains the traffic count worksheets used in this study.*

Current Levels of Service

All level-of-service analyses described in this report were performed in accordance with the procedures stated in the *2000 Highway Capacity Manual* (Reference 2). *A description of level of service and the criteria by which they are determined is presented in Appendix "B".* Appendix "B" also indicates how level of service is measured and what is generally considered the acceptable range of level of service. Intersection level of service (LOS) is analogous to the letter grades in a school report card. Motorists using an intersection that operates at LOS "A" experience very little delay, while those using an intersection that operates at LOS "F" will experience intolerably long delays. Additionally, *2010 Highway Capacity Manual* (Reference 3) analysis has been conducted for ODOT maintained intersections.

H:\profile\18152 - Villa Road Apartments\dwgs\18152_figs.dwg Feb 13, 2015 - 4:55pm - pmarnell Layout Tab: 03

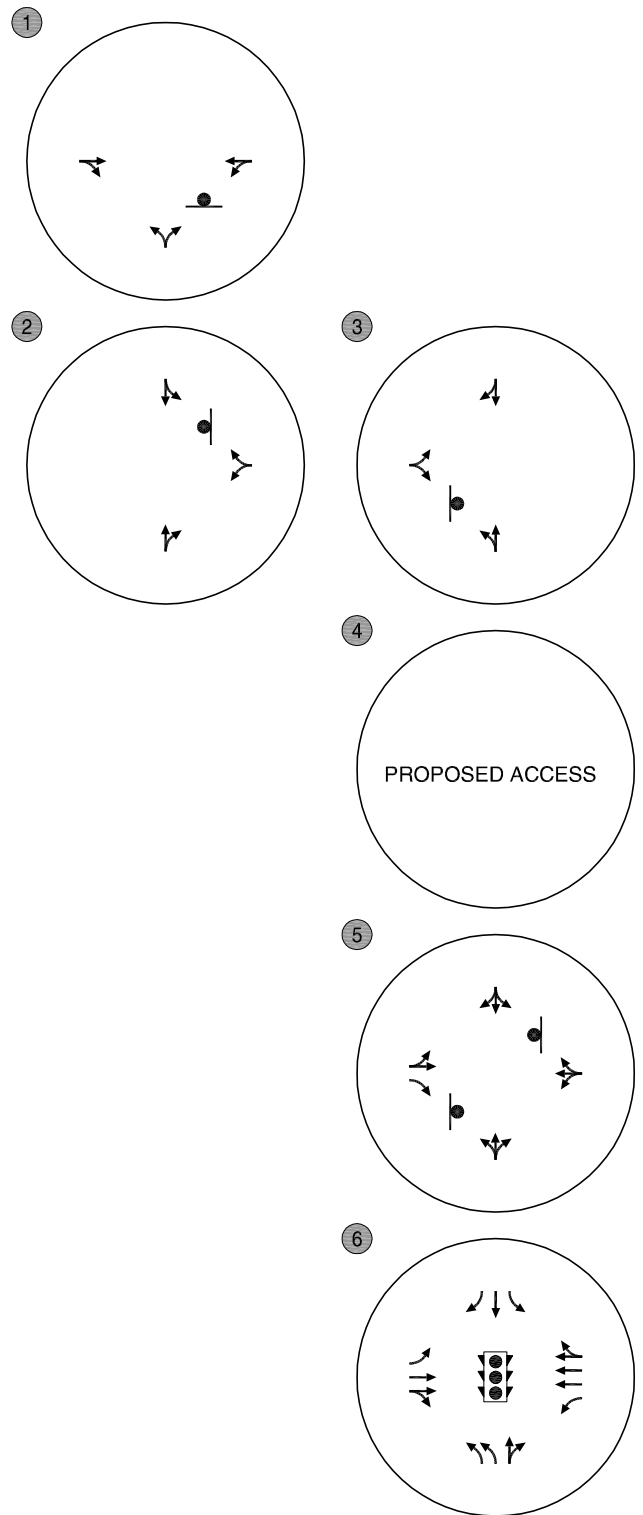

LEGEND

-  - STOP SIGN
-  - TRAFFIC SIGNAL

EXISTING LANE CONFIGURATIONS AND TRAFFIC CONTROL DEVICES NEWBERG, OREGON

FIGURE 3



(NO SCALE)

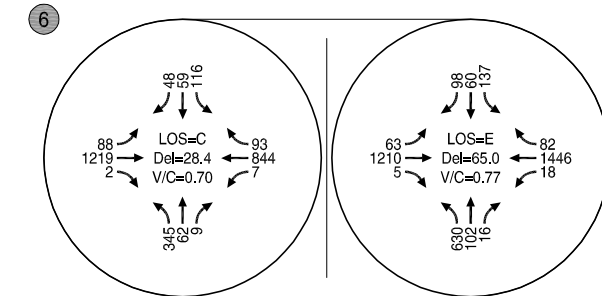
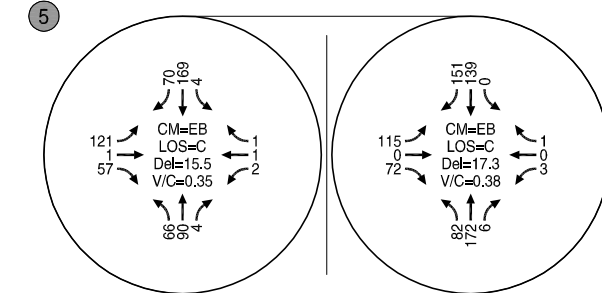
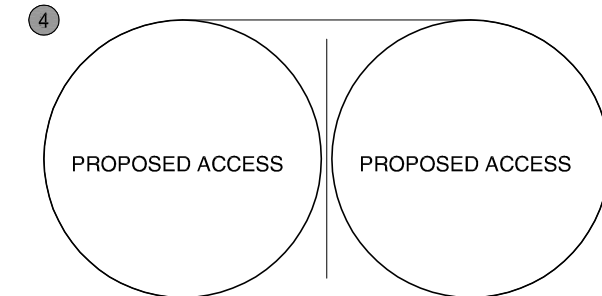
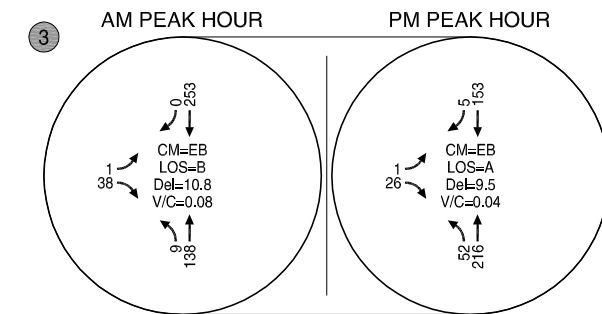
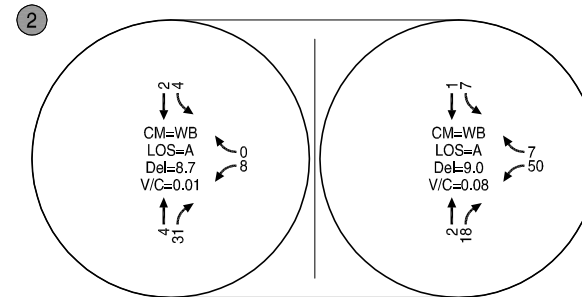
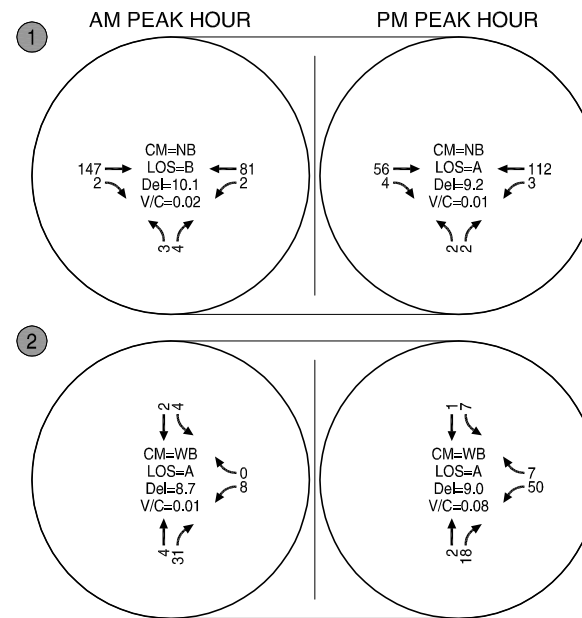
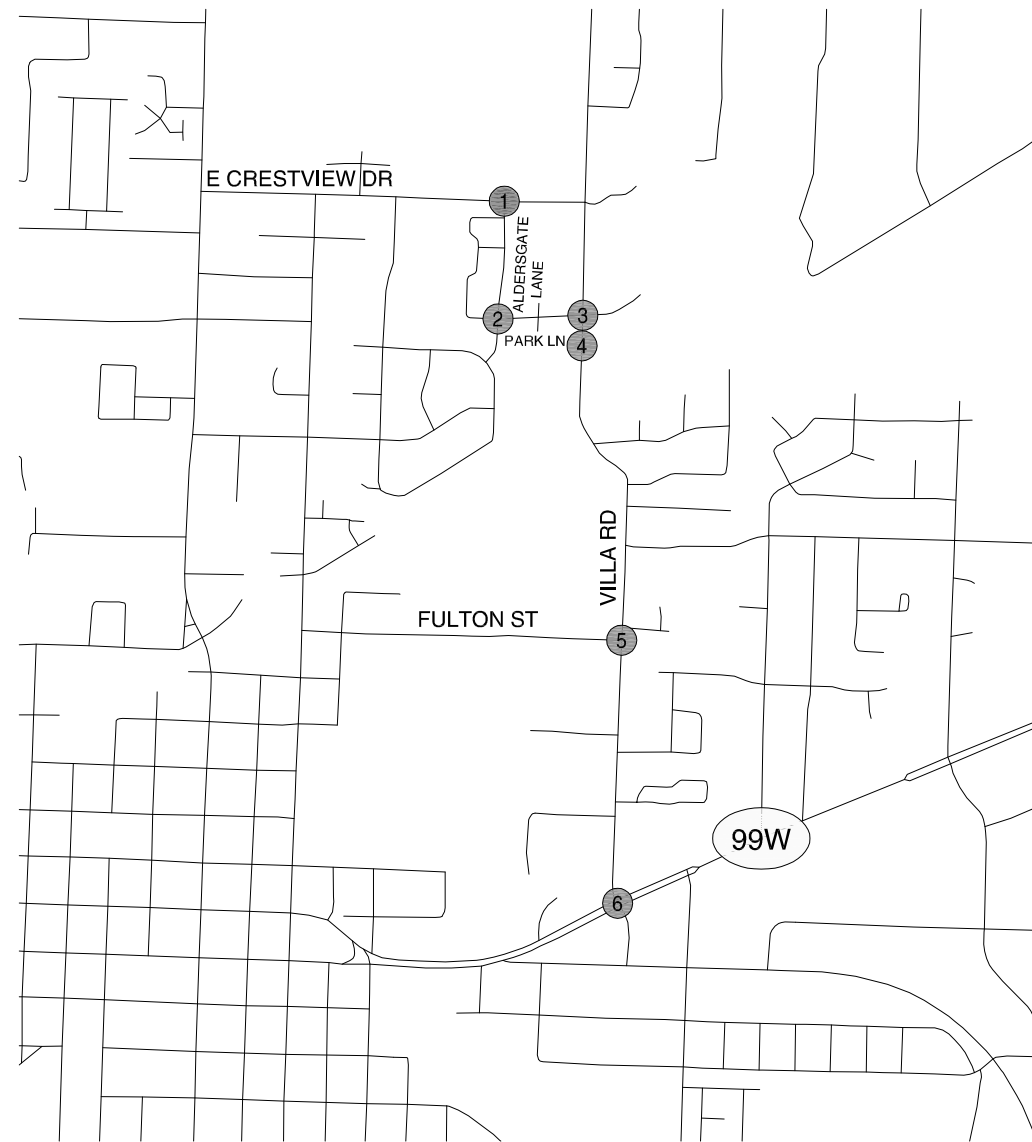

LEGEND

- CM = CRITICAL MOVEMENT (TWSC)
- LOS = INTERSECTION LEVEL OF SERVICE (SIGNALIZED/AWSC)/CRITICAL MOVEMENT LEVEL OF SERVICE (TWSC)
- Del = INTERSECTION AVERAGE CONTROL DELAY (SIGNALIZED/AWSC) / CRITICAL MOVEMENT CONTROL DELAY (TWSC)
- V/C = CRITICAL VOLUME-TO-CAPACITY RATIO
- TWSC = TWO-WAY STOP CONTROL
- AWSC = ALL-WAY STOP CONTROL

EXISTING TRAFFIC CONDITIONS
WEEKDAY AM AND PM PEAK HOURS
NEWBERG, OREGON

FIGURE 4

H:\projfiles\18152 - Villa Road Apartments\dwgs\18152_figs.dwg Feb 13, 2015 - 4:38pm - pmarnell Layout Tab: 04

All of the study intersections, except the Villa Road/OR 99W intersection, are City maintained. The City of Newberg has a level of service standard for signalized and unsignalized intersections of LOS "D" or better. The Villa Road/OR 99W intersection is ODOT maintained. ODOT uses the v/c ratio to evaluate intersection performance. Per the *Oregon Highway Plan* (Reference 4) the v/c ratio mobility target for this intersection 0.85 or less during peak hours.

All intersection level-of-service evaluations used the peak 15-minute flow rate during the weekday a.m. and p.m. peak hours. Using the peak 15-minute flow rate ensures that this analysis is based on a reasonable worst-case scenario. For this reason, the analysis reflects conditions that are only likely to occur for 15 minutes out of each average peak hour. The transportation system will likely operate under conditions better than those described in this report during all other time periods.

Figure 4 also summarizes the existing operations for all study intersections under the weekday a.m. and p.m. peak hours. All of the study intersections currently operate at levels of service and v/c ratios that meet agency standards during the weekday a.m. and p.m. peak hours. *Appendix "C" includes the level-of-service worksheets under existing traffic conditions.*

Traffic Safety

The reported crash histories at all study intersections was reviewed to identify potential safety issues. ODOT provided crash records from the study intersections for the five-year period, from January 1, 2009, through December 31, 2013. Table 2 summarizes the crash data at study the existing intersections. *Appendix "D" includes the crash data sheets.*

Table 2: Intersection Crash Summary (2009-20013)

Intersection	Crash Type						Severity		Total Crashes	Crashes per MEV ²
	Rear End	Right Angle	Turning	Pedestrian or Bike	Side Swipe	Other	PDO*	Injury		
Aldersgate Lane/Crestview Drive	N/A ¹	N/A ¹	N/A ¹	N/A ¹	N/A ¹	N/A ¹	N/A ¹	N/A ¹	N/A ¹	N/A ¹
Aldersgate Lane/Park Lane	-	-	-	-	-	-	-	-	0	-
Villa Road/Park Lane	-	-	-	-	-	-	-	-	0	-
Villa Road/Fulton Street	-	-	-	-	-	-	-	-	0	-
Villa Road/OR 99W	24	0	6	0	1	2	21	12	33	0.46

¹No ODOT crash data was reported for this intersection.

²Million Entering Vehicles, as determined by multiplying PM peak hour entering volumes by a factor of 10 to estimate daily traffic.

As shown in Table 2, no crashes were reported at study intersections other than the Villa Road/OR 99W intersection. Of the 33 crashes at this intersection, 24 were rear-end collisions. Rear end crashes are common at signalized intersections. The crash rate per million entering vehicles (MEV) at this study intersection was below 1.0. No safety deficiencies were identified at this or the other remaining study intersections based on reported crash histories. Additionally, the crash history for the segment of Villa Road, not including the study intersections, was analyzed between Park Lane and OR 99W. Of the four crashes reported in this segment three involved bicycles. This patterns indicates a potential need for additional bicycle connectivity or facility enhancements.

Section 4
Transportation Impact Analysis

TRANSPORTATION IMPACT ANALYSIS

The transportation impact analysis identifies how the study area's transportation system will operate in the year the proposed development is expected to be fully occupied (2016) and over the long-term planning horizon year (2035). The impact of traffic generated by the proposed Martell Commons project during the typical weekday a.m. and p.m. peak hours was examined as follows:

- Background traffic conditions for the years 2016 (build-out year of the proposed development) were analyzed at each of the study intersections during the weekday a.m. and p.m. peak hours.
- Background conditions were developed by applying a 6.63-percent annual growth rate to the existing traffic volumes to account for expected short-term growth in the site vicinity.
- Site-generated trips were estimated for the Martell Commons development.
- Site trip-distribution patterns were based on existing traffic patterns and the location of major trip origins and destinations in the area, including George Fox University.
- Year 2016 (build-out year of the proposed Martell Commons development) traffic conditions were analyzed at each of the study intersections during the weekday a.m. and p.m. peak hours.

Additionally, to analyze the effects of the proposed rezone from R-1 Low Density Residential to R-3 High Density Residential, a long-term analysis was conducted for the planning horizon year 2035 as follows:

- Background traffic conditions for the year 2035 (TSP planning horizon year) were analyzed at each of the study intersections during the weekday p.m. peak hour. Background traffic volumes were developed based on the City's TSP Update which includes volumes at select intersections such as Villa Road/OR 99W and Villa Road/Fulton Street.
- A reasonable worst case site development scenario was developed under the proposed R-3 High Density Residential zoning and under the existing R-1 Low Density Residential Zoning. The difference in the two scenarios represents the increase in potential traffic volumes that could be caused by the proposed rezone.
- Site trip-distribution patterns were derived as described above, with increased traffic volumes associated with the zone change assigned to the existing study intersections.
- Year 2035 (TSP planning horizon year) traffic conditions were analyzed at each of the study intersections and the proposed site-access to Villa Road during the weekday p.m. peak hour.

YEAR 2016 BACKGROUND TRAFFIC CONDITIONS

The year 2016 background traffic analysis identifies how the study area's transportation system will operate without the proposed Martell Commons development. As stated previously, a 6.63-percent annual growth was used to account for background traffic growth. This growth rate was based on the

average growth rate between the 2014 turning-movement counts and the year 2035 forecast volumes from the City's Transportation System Plan (TSP) update for key intersections along Villa Road.

No planned in-process developments were identified within the study area through discussions with city staff. Figure 5 displays the resulting forecast year 2016 background traffic volumes during the weekday a.m. and p.m. peak hours.

Operations Analysis

Figure 5 also summarizes the background traffic operations analysis for the study intersections under the weekday a.m. and p.m. peak hours. All City-maintained study intersections are forecast to operate at acceptable levels of service during both the weekday a.m. and p.m. peak hours. The Villa Road/OR 99W intersection is forecast to operate with a v/c ratio of 0.88 during the p.m. peak hour, and this value exceed the ODOT mobility target of 0.85. *Appendix "E" contains the year 2016 background traffic level-of-service worksheets.*

PROPOSED DEVELOPMENT PLAN

DJ2 Holdings, LLC is proposing to develop an up to 128 unit apartment complex known as the Martell Commons. The development will have a single driveway connection to Villa Road and two driveways to Park Lane, as shown in the site plan in Figure 2 and lane configurations exhibit in Figure 6. Additionally, site frontage improvements will be made along one or both sides of the Villa Road site frontage including bicycle lanes, sidewalks, and landscaping. Further, the developer desires to connect the new sidewalk on the west side of Villa Road with an existing pedestrian trail at the south end of the project, which provides connectivity to George Fox University. Additional coordination and cooperation will be needed with the City and University to ensure this connection can be made.

Construction is expected to begin in this year 2015 with anticipated build-out and occupancy in 2016.

Site Trip Generation

The projected weekday daily, a.m., and p.m. peak-hour vehicle trip ends for the proposed development were based on the *Trip Generation Manual*, 9th Edition (Reference 5). Table 3 summarizes the anticipated number of trips that will be generated by the proposed Martell Commons development.

Table 3: Estimated Martell Commons Trip Generation

Land Use	ITE Code	Size	Daily Trips	Weekday AM Peak Hour Trips			Weekday PM Peak Hour Trips		
				Total	In	Out	Total	In	Out
Apartments	220	128 units	899	66	13	53	88	57	31



(NO SCALE)

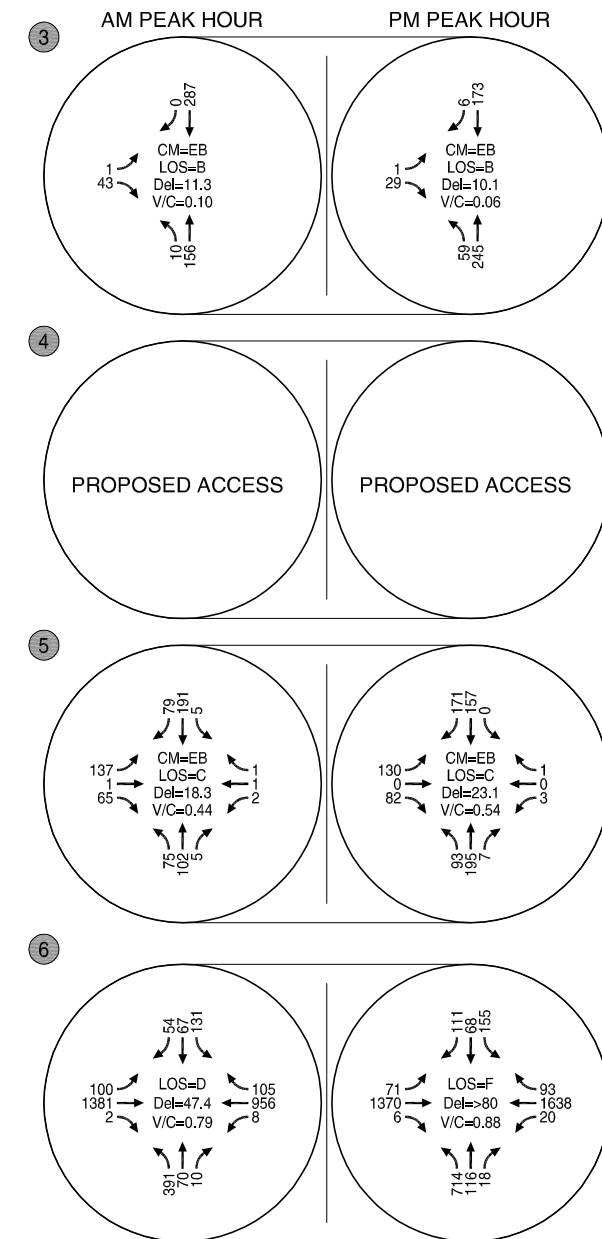
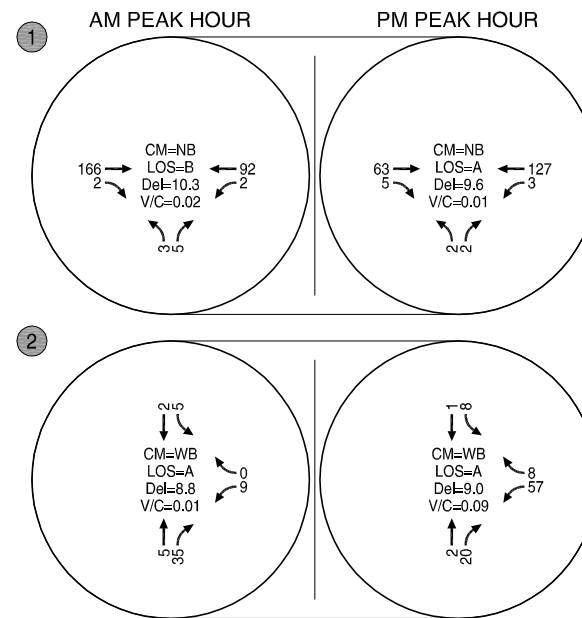
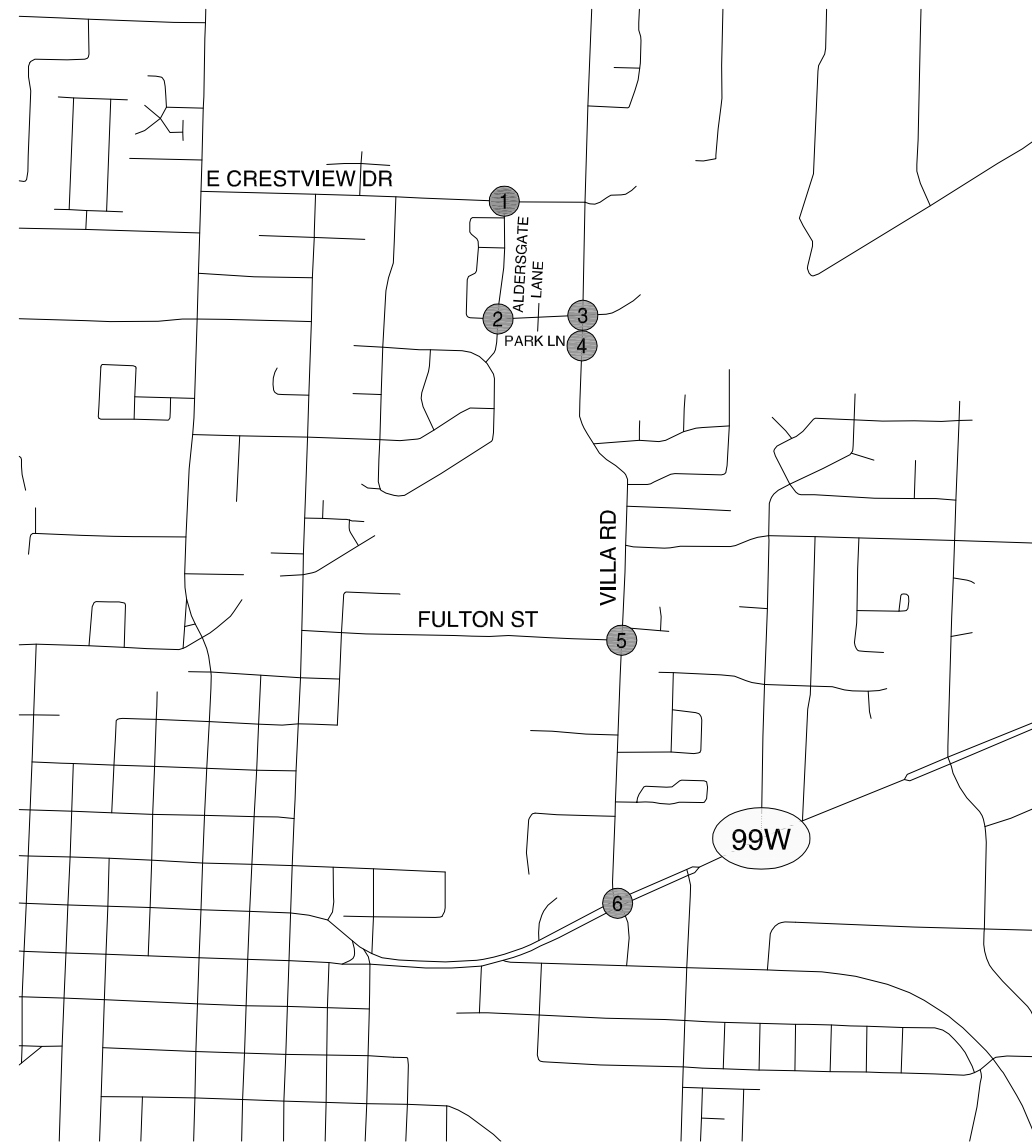

LEGEND

- CM = CRITICAL MOVEMENT (TWSC)
- LOS = INTERSECTION LEVEL OF SERVICE (SIGNALIZED/AWSC)/CRITICAL MOVEMENT LEVEL OF SERVICE (TWSC)
- Del = INTERSECTION AVERAGE CONTROL DELAY (SIGNALIZED/AWSC) / CRITICAL MOVEMENT CONTROL DELAY (TWSC)
- V/C = CRITICAL VOLUME-TO-CAPACITY RATIO
- TWSC = TWO-WAY STOP CONTROL
- AWSC = ALL-WAY STOP CONTROL

2016 BACKGROUND TRAFFIC CONDITIONS
WEEKDAY AM AND PM PEAK HOURS
NEWBERG, OREGON



FIGURE 5

H:\proj\18152 - Villa Road Apartments\dwgs\18152_figs.dwg Feb 13, 2015 - 4:38pm - pmarnell Layout Tab: 05

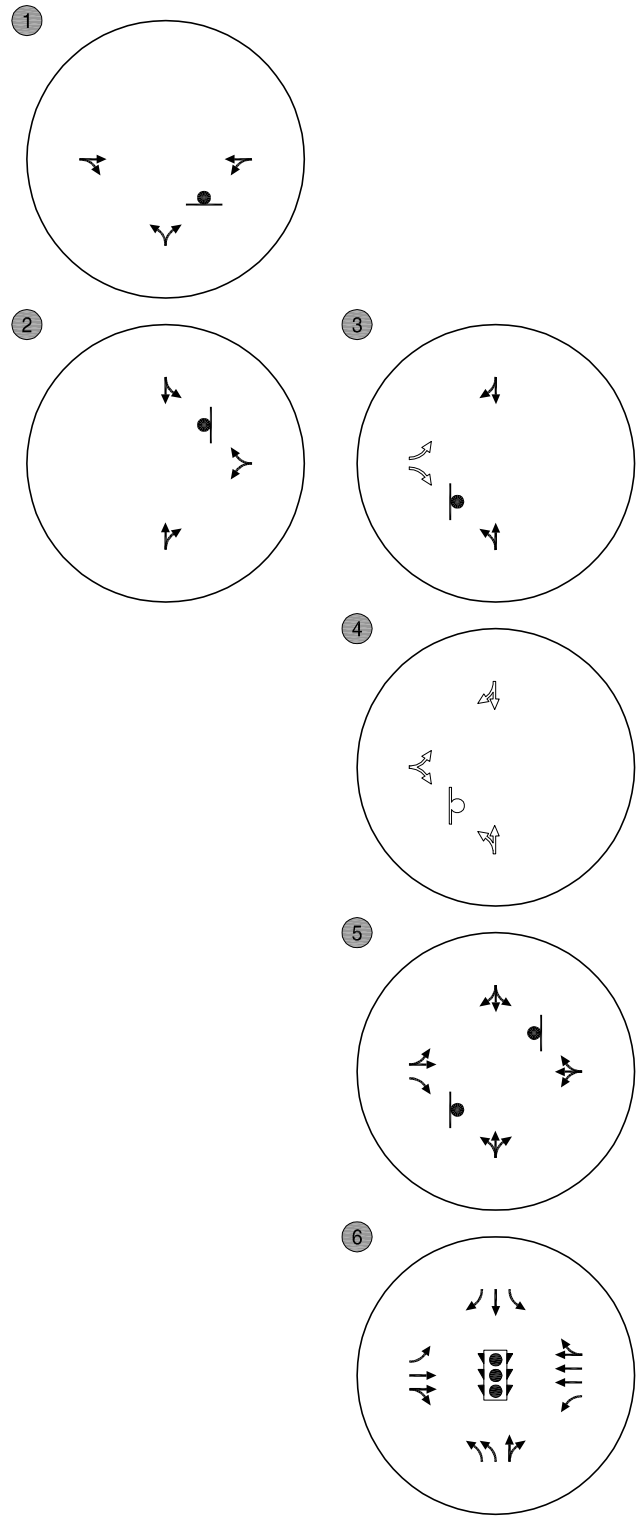
H:\profile\18152 - Villa Road Apartments\dwgs\18152_figs.dwg Feb 13, 2015 - 4:55pm - pmarnell Layout Tab: 06



LEGEND

-  - PROPOSED
-  - STOP SIGN
-  - TRAFFIC SIGNAL

PROPOSED LANE CONFIGURATIONS AND TRAFFIC CONTROL DEVICES NEWBERG, OREGON

FIGURE 6

Site Trip Distribution/Trip Assignment

The site-generated trips were distributed onto the study area roadway system according to the existing traffic patterns and the location of the development site relative to major trip origins and destinations in the City (such as George Fox University). Figure 7 illustrates the estimated trip distribution pattern for the proposed development and how the site-generated trips are expected to use the roadway within the study area during the weekday a.m. and p.m. peak hours. Due to the close proximity of the proposed apartments to George Fox University, and the high probability of student occupants, 25% of generated trips were assigned to/from the George Fox University campus.

YEAR 2016 TOTAL TRAFFIC CONDITIONS

The total traffic conditions analysis forecasts how the study area's transportation system will operate with the traffic generated by the proposed Martell Commons development. The year 2016 background traffic volumes for the weekday a.m. and p.m. peak hours (shown in Figure 5) were added to the site-generated traffic (shown in Figure 7) to arrive at the total traffic volumes that are shown in Figure 8.

Intersection Level of Service

Figure 8 also summarizes the traffic operations analysis for the study intersections under weekday a.m. and p.m. peak hour total traffic conditions. All City-maintained study intersections and the proposed site access to Villa Road are forecast to operate at acceptable levels of service during both the weekday a.m. and p.m. peak hours. The Villa Road/OR 99W intersection is forecast to continue to operate with a v/c ratio of 0.88 during the p.m. peak hour. Although this value exceeds the ODOT mobility target of 0.85, it does not represent an increase relative to the background condition. This indicates the proposed site development will not materially affect operating conditions at this intersection. *Appendix "F" contains the year 2016 total traffic level-of-service worksheets.*

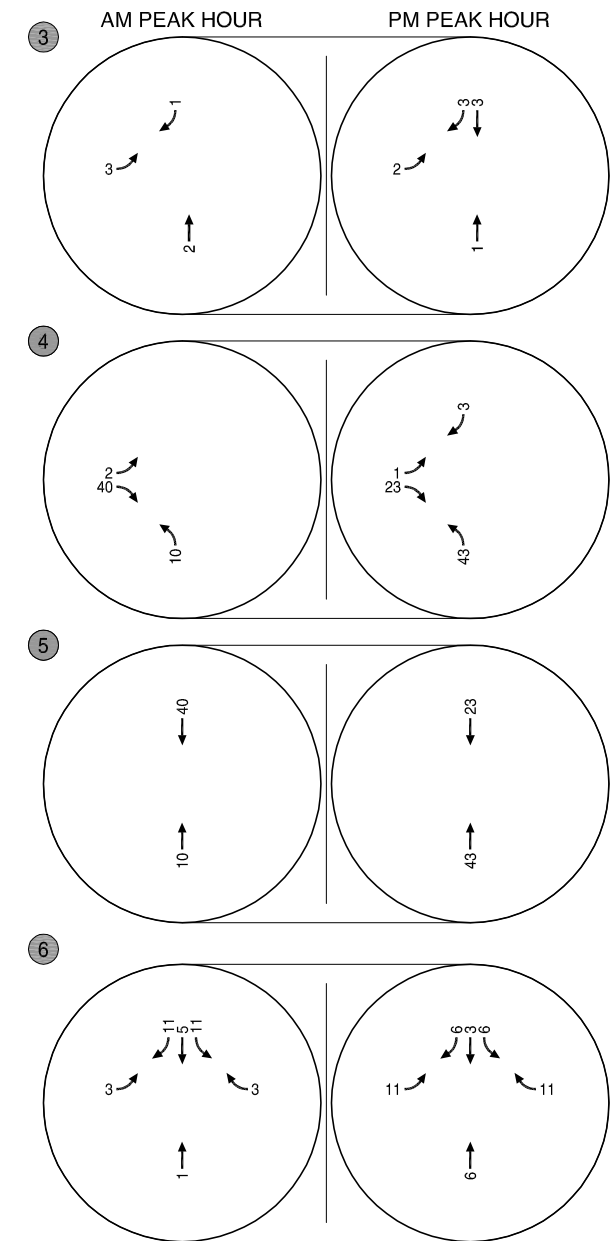
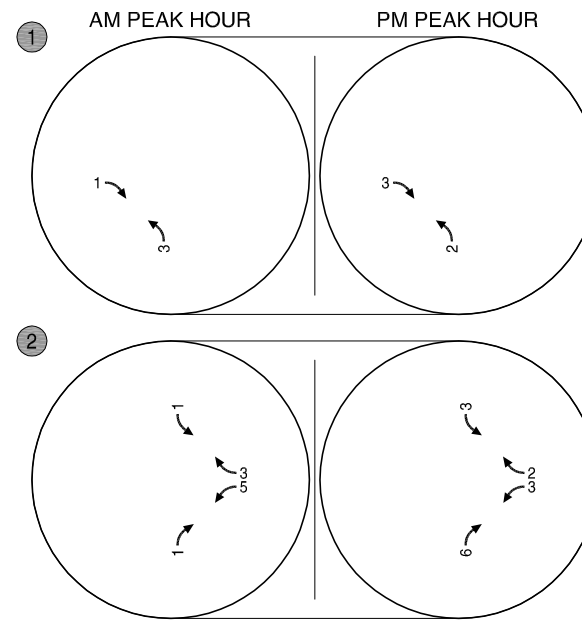
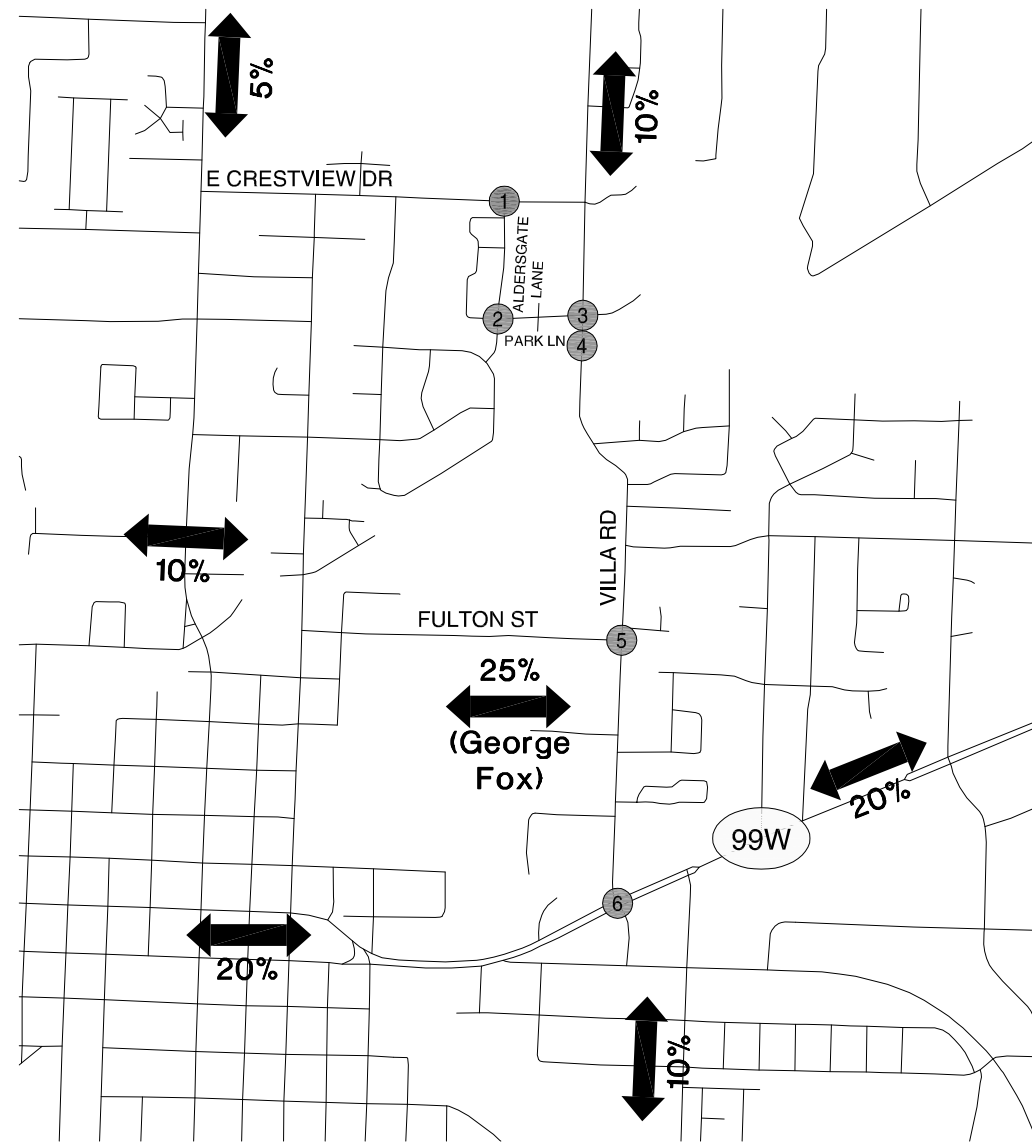

2016 TRIP GENERATION AND DISTRIBUTION
WEEKDAY AM AND PM PEAK HOURS
NEWBERG, OREGON

FIGURE
7

H:\projfiles\18152 - Villa Road Apartments\dwgs\18152_figs.dwg Feb 13, 2015 - 4:38pm - pmarnell Layout Tab: 07



(NO SCALE)

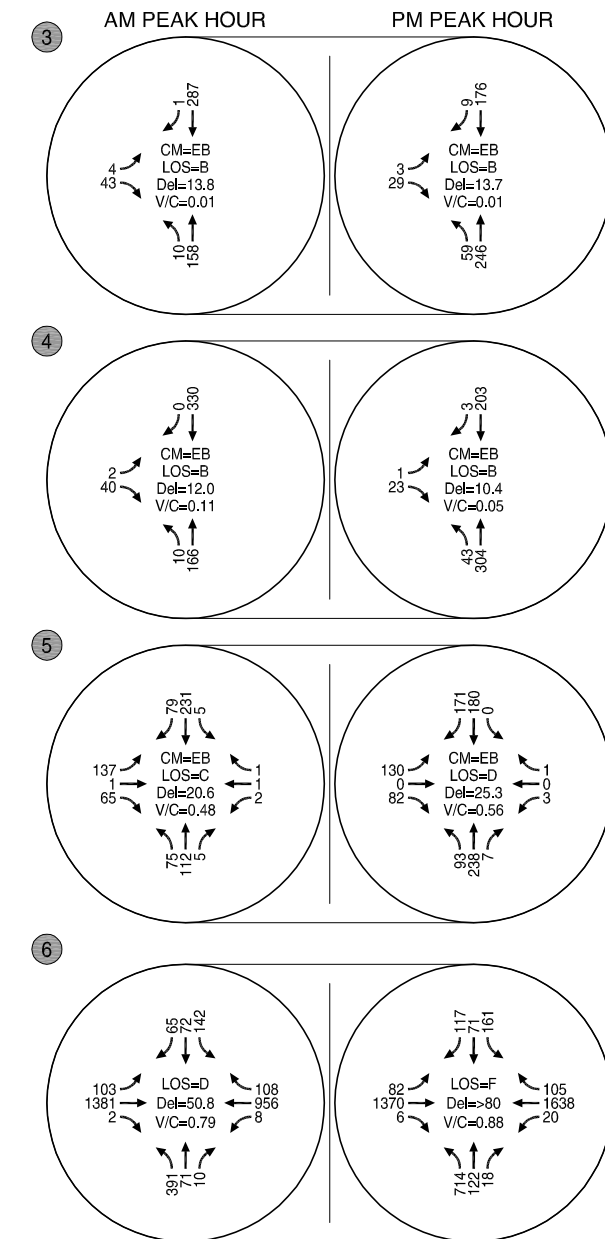
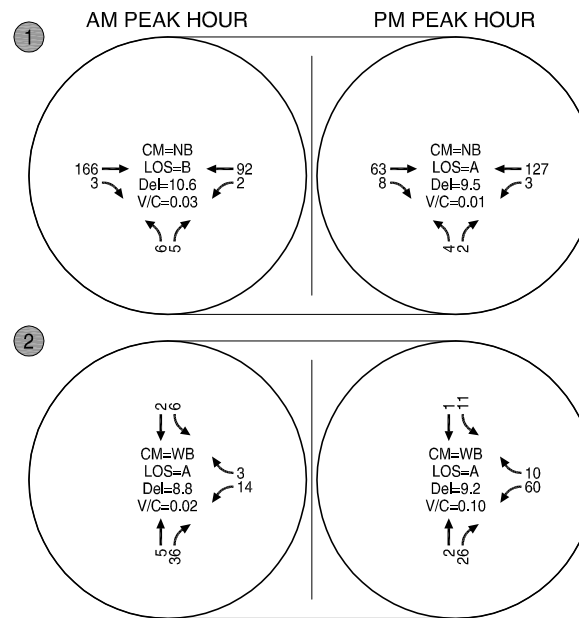
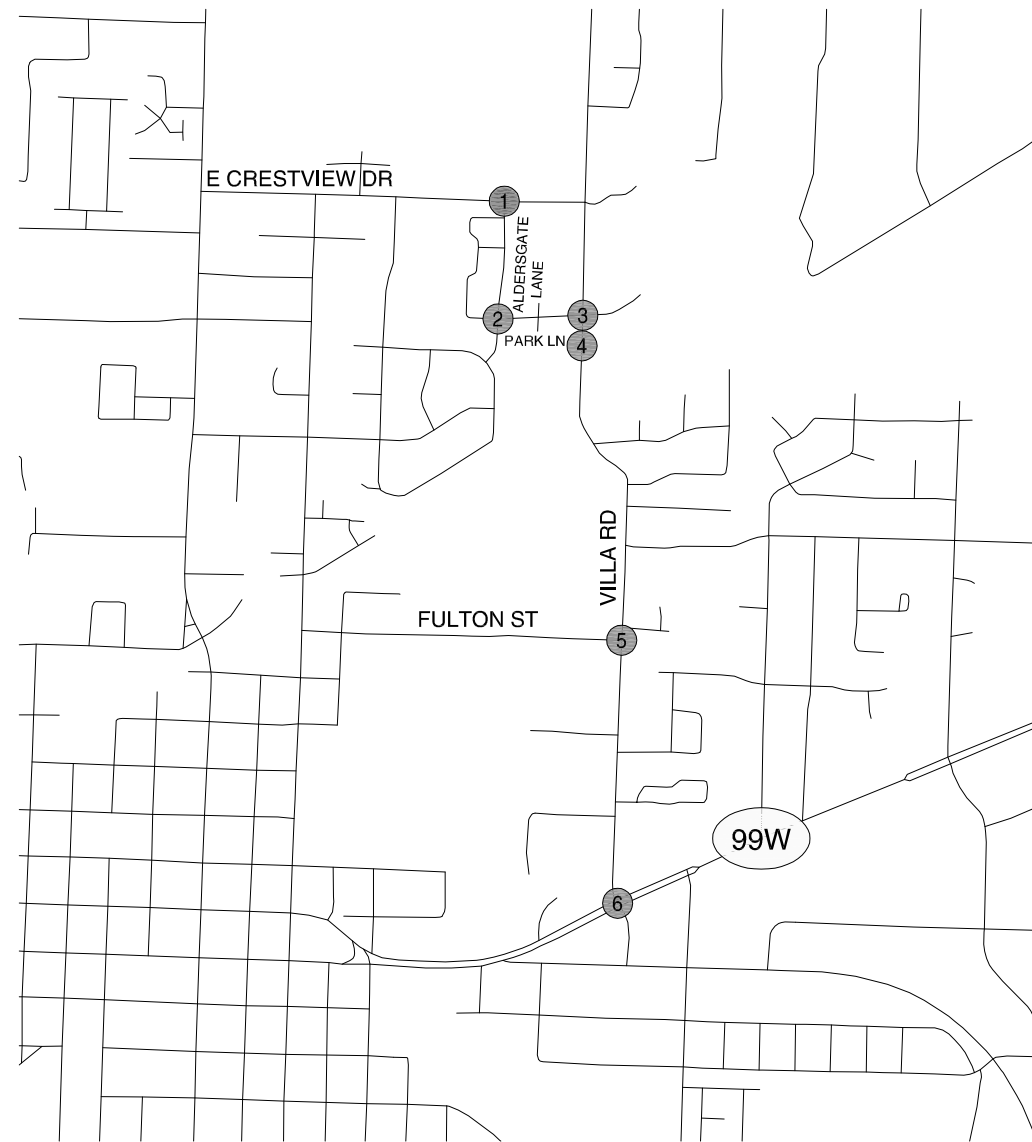

LEGEND

- CM = CRITICAL MOVEMENT (TWSC)
- LOS = INTERSECTION LEVEL OF SERVICE (SIGNALIZED/AWSC)/CRITICAL MOVEMENT LEVEL OF SERVICE (TWSC)
- Del = INTERSECTION AVERAGE CONTROL DELAY (SIGNALIZED/AWSC) / CRITICAL MOVEMENT CONTROL DELAY (TWSC)
- V/C = CRITICAL VOLUME-TO-CAPACITY RATIO
- TWSC = TWO-WAY STOP CONTROL
- AWSC = ALL-WAY STOP CONTROL

2016 TOTAL TRAFFIC CONDITIONS WEEKDAY AM AND PM PEAK HOURS NEWBERG, OREGON

FIGURE 8

H:\proj\18152 - Villa Road Apartments\dwgs\18152_figs.dwg Feb 13, 2015 - 4:38pm - pmarnell Layout Tab: 08

YEAR 2035 BACKGROUND TRAFFIC CONDITIONS

The year 2035 background traffic analysis identifies how the study area's transportation system will operate without the proposed zone change and assuming the site is reasonably developed to its fullest potential under current zoning.

Traffic Forecast Volumes

As stated previously, these volumes were based on the year 2035 volume forecasts from the City's TSP update. The City's TSP update accounts for anticipated growth in land uses as well as major transportation projects that are funded and expected to be built by the year 2035, including Phase 1 of the Newberg-Dundee Bypass. Figure 9 displays the forecast year 2035 background traffic volumes during the weekday p.m. peak hour, which is the only travel time period assessed in the TSP.

Operations Analysis

Figure 9 also summarizes the traffic operations analysis for the study intersections under the weekday p.m. peak hour background traffic condition. All City-maintained study intersections, except Villa Road/Fulton Street, are forecast to operate at acceptable levels of service during the weekday p.m. peak hour. The Villa Road/Fulton Street intersection is forecast to operate at LOS "F" which exceeds the City's mobility target of LOS "D" or better. Additionally, the Villa Road/OR 99W intersection is forecast to operate with a v/c ratio of 1.11 during the p.m. peak hour, which exceeds the ODOT mobility target of 0.85. *Appendix "G" contains the year 2035 background traffic level-of-service worksheets.*

YEAR 2035 TOTAL TRAFFIC CONDITIONS

The total traffic conditions analysis forecasts how the study area's transportation system will operate in 2035, if the proposed zone change occurs and the site is reasonably developed to its fullest potential.

Traffic Forecast Volumes

The year 2035 site-generated traffic volumes were developed based on reasonable worst case estimates for site development scenarios under the existing R-1 Low Density Residential zoning (30 single family homes) and the proposed R-3 High Density Residential zoning (168 apartment units). Table 2 displays the reasonable worst case trip generation for both zoning scenarios as well as the net difference between them. As shown, the proposed rezone has the potential to increase site trips by 795 average daily trips, 55 weekday a.m. peak hour trips, and 74 weekday p.m. peak hour trips.

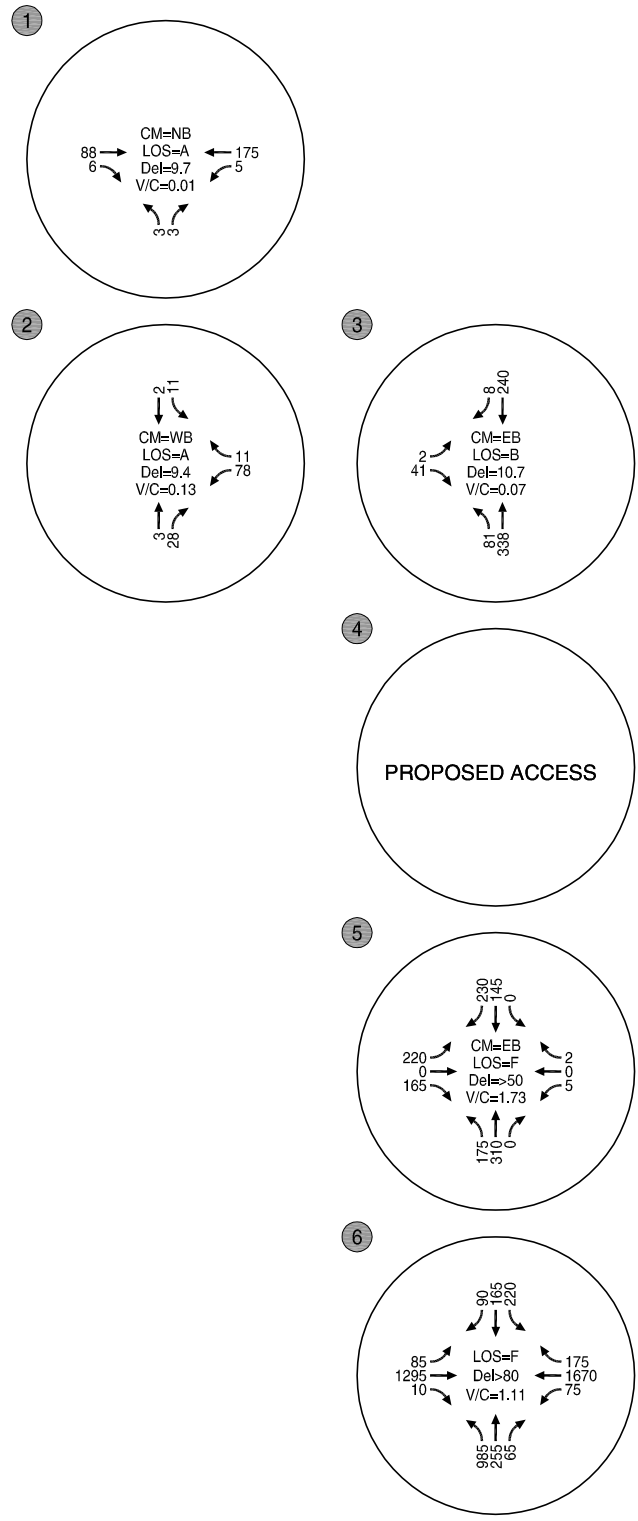

H:\profile\18152 - Villa Road Apartments\dwgs\18152_figs.dwg Feb 13, 2015 - 4:55pm - pmarnell Layout Tab: 09

LEGEND

- CM = CRITICAL MOVEMENT (TWSC)
- LOS = INTERSECTION LEVEL OF SERVICE (SIGNALIZED/AWSC)/CRITICAL MOVEMENT LEVEL OF SERVICE (TWSC)
- Del = INTERSECTION AVERAGE CONTROL DELAY (SIGNALIZED/AWSC) / CRITICAL MOVEMENT CONTROL DELAY (TWSC)
- V/C = CRITICAL VOLUME-TO-CAPACITY RATIO
- TWSC = TWO-WAY STOP CONTROL
- AWSC = ALL-WAY STOP CONTROL

2035 BACKGROUND TRAFFIC CONDITIONS
WEEKDAY PM PEAK HOURS
NEWBERG, OREGON

Table 4: 2035 Reasonable Worst Case Trip Generation Scenarios

Zoning	Land Use	ITE Code	Size	Daily Trips	Weekday AM Peak Hour Trips			Weekday PM Peak Hour Trips		
					Total	In	Out	Total	In	Out
R-3 (proposed)	Apartments	220	168 units	1,142	86	17	69	110	72	38
R-1 (existing)	Single Family Housing	210	30 units	347	31	8	23	36	23	13
Net Difference (Increase)				795	55	9	46	74	49	25

Site Trip Distribution/Trip Assignment

The estimated increase in site-generated trips shown in Table 4 above were distributed onto the study area roadways according to existing traffic patterns, and the location of major trip origins and destinations in the City. Figure 10 illustrates the estimated trip distribution pattern for the proposed development and how the site-generated trips are expected to use the roadways within the study area during the weekday p.m. peak hour. Again, due to the close proximity of the proposed apartments to George Fox University, and the high probability of student occupants, 25% of generated trips were assigned to/from the George Fox University campus.

The year 2035 background traffic volumes (shown in Figure 9) for the weekday p.m. peak hour were added to the year 2035 p.m. peak hour site-generated traffic volumes (shown in Figure 10) to arrive at the year 2035 total traffic volumes that are shown in Figure 11.

Intersection Operations

Figure 11 also summarizes the traffic operations analysis for the study intersections under the weekday p.m. peak hour total traffic condition. All City-maintained study intersections, except Villa Road/Fulton Street, are forecast to operate at acceptable levels of service during the weekday p.m. peak hour. The Villa Road/Fulton Street intersection is forecast to operate at LOS "F" which exceeds the City's mobility target of LOS "D" or better. Additionally, the Villa Road/OR 99W intersection is forecast to operate with a v/c ratio of 1.12 during the p.m. peak hour, which exceeds the ODOT mobility target of 0.85.

Potential mitigation measures for both study intersections are addressed in the following section. However, it should be emphasized that the Villa Road/OR 99W intersection is forecast to experience a very small increase (0.01) in the v/c ratio compared to 2035 background conditions. Further discussion regarding how this intersection will not be significantly affected by the proposed rezone is included. *Appendix "H" includes the year 2035 total traffic level-of-service worksheets.*

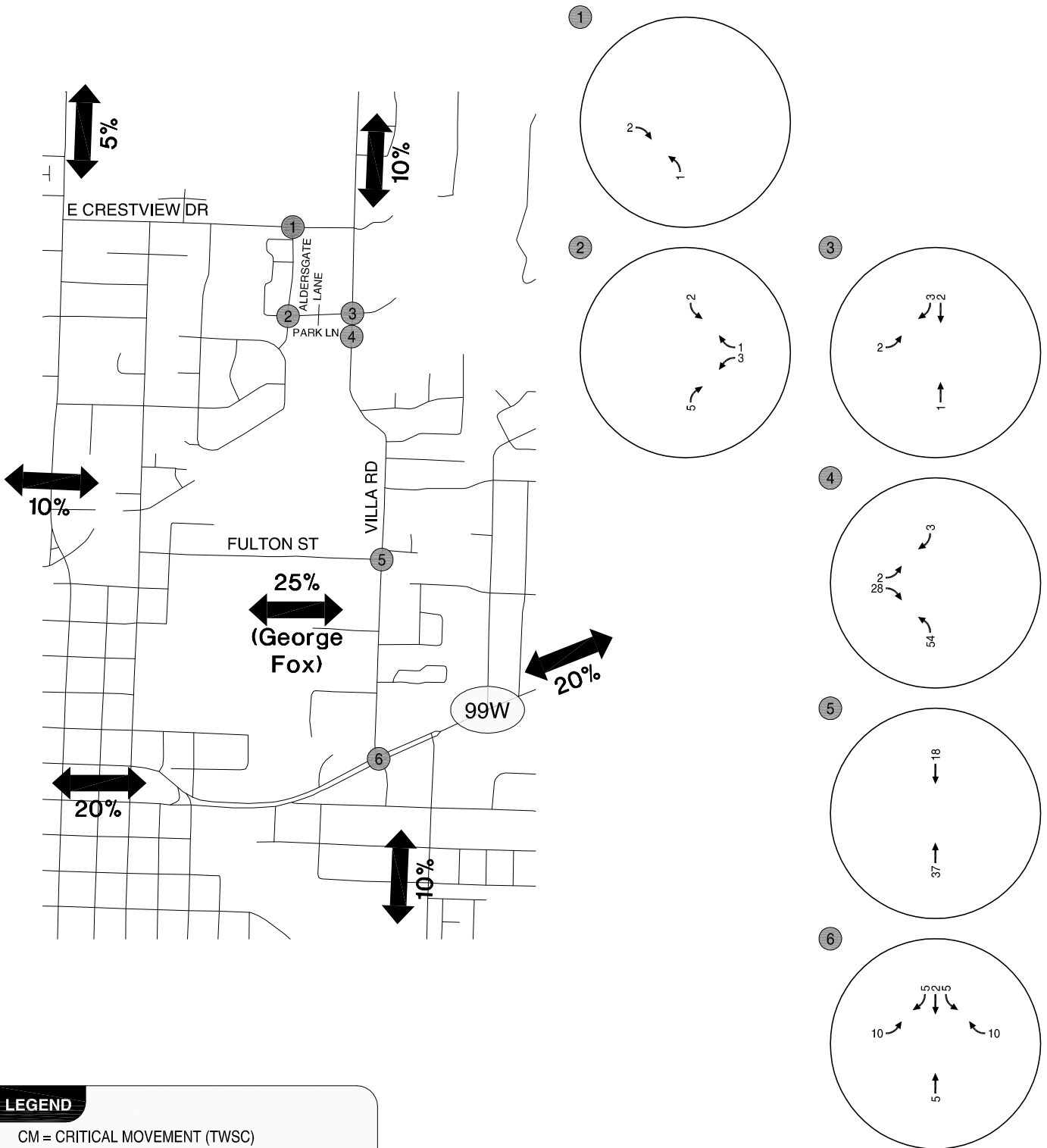

H:\profile\18152 - Villa Road Apartments\dwgs\18152_figs.dwg Feb 13, 2015 - 4:55pm - pmarnell Layout Tab: 10

LEGEND

- CM = CRITICAL MOVEMENT (TWSC)
- LOS = INTERSECTION LEVEL OF SERVICE (SIGNALIZED/AWSC)/CRITICAL MOVEMENT LEVEL OF SERVICE (TWSC)
- Del = INTERSECTION AVERAGE CONTROL DELAY (SIGNALIZED/AWSC) / CRITICAL MOVEMENT CONTROL DELAY (TWSC)
- V/C = CRITICAL VOLUME-TO-CAPACITY RATIO
- TWSC = TWO-WAY STOP CONTROL
- AWSC = ALL-WAY STOP CONTROL

2035 TRIP GENERATION AND DISTRIBUTION WEEKDAY PM PEAK HOURS NEWBERG, OREGON

H:\project\18152 - Villa Road Apartments\dwgs\18152_figs.dwg Feb 13, 2015 - 4:55pm - pmarnell Layout Tab: 11

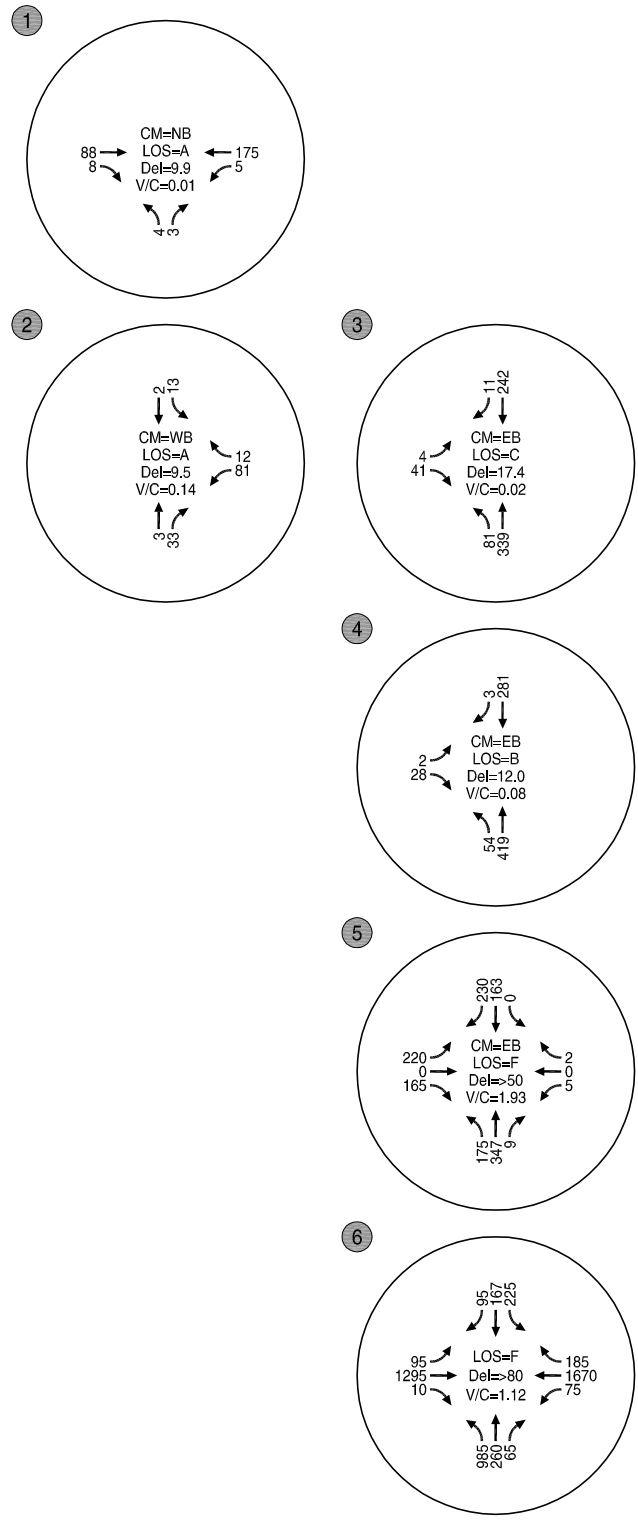

LEGEND

- CM = CRITICAL MOVEMENT (TWSC)
- LOS = INTERSECTION LEVEL OF SERVICE (SIGNALIZED/AWSC)/CRITICAL MOVEMENT LEVEL OF SERVICE (TWSC)
- Del = INTERSECTION AVERAGE CONTROL DELAY (SIGNALIZED/AWSC) / CRITICAL MOVEMENT CONTROL DELAY (TWSC)
- V/C = CRITICAL VOLUME-TO-CAPACITY RATIO
- TWSC = TWO-WAY STOP CONTROL
- AWSC = ALL-WAY STOP CONTROL

2035 TOTAL TRAFFIC CONDITIONS
WEEKDAY PM PEAK HOURS
NEWBERG, OREGON

FIGURE
11

Potential Villa Road/Fulton Street Mitigation

This intersection is projected to operate at LOS “F” during the 2035 weekday p.m. peak hour regardless of the site development, due to increased traffic forecasted on all street approaches. The currently adopted *2005 Transportation System Plan* (Reference 6) references a project to install either a traffic signal, roundabout, or four-way stop at this intersection.

As a potential interim step to a full signalization, it is recommended that all way stop control be established at this intersection to delay the onset of adverse operating conditions. With this change in place, the Villa Road/Fulton Street intersection is forecast to operate at LOS “E” in 2035, which still exceeds the City’s mobility target but is a relative improvement over the LOS “F” condition forecast for 2035 background and total traffic conditions. In addition, this change would provide better intersection access for movements associated with Fulton Street and enhance the ability for pedestrian crossings. *Appendix “I” includes the year 2035 mitigated total traffic level-of-service worksheets.*

Potential Villa Road/OR 99W Mitigation

There are no practical capacity-enhancing measures that can be implemented for this intersection given the built-up environment, limited amount of right-of-way, and the fact that the intersection already has multiple travel lanes on all approaches. With a forecasted v/c ratio over 1.0, the intersection will operate in an oversaturated condition. These poor operating conditions are mostly attributed to the dramatic increase in left-turn demand that is forecast for the south leg of Villa Road, which is likely related to completion of Phase 1 of the Newberg-Dundee Bypass.

While this intersection is projected to exceed the ODOT v/c mobility standard in 2035 without or with the proposed rezone and development in place, the proposed development site is far removed from this intersection, at over two-thirds of a mile away. Also, the net effect of the proposed zone change is negligible, as seen by the 0.01 increase in the intersection v/c ratio. This is important to note because the Oregon Highway Plan specifically allows for minor increases in site trips when considering a property rezone (OHP Action 1F.5), up to 400 average daily trips (ADT). As shown in Table 4, an increase of 795 ADT is estimated with proposed rezone. However, because the site’s distance from OR 99W and the selected site trip distribution pattern, only 50% of this total, or 397 ADT is expected to reach the highway. This equates to a sub-400 ADT increase for the highway intersection, which means the proposed rezone will avoid further degradation to highway operations.

There are additional performance improving actions outlined in OHP Action 1F.5 designed to mitigate the traffic impacts of a rezone. They are as follows:

- System connectivity improvements for vehicles, bicycles, and pedestrians.
- Transportation demand management methods to reduce the need for additional capacity.
- Multi-modal (bicycle, pedestrian, transit) opportunities to reduce vehicle demand.
- Operational improvements to maximize use of the existing system.
- Land use techniques such as trip caps/budgets to manage trip generation.

The off-site improvements proposed for the Villa Road site frontage, which include bicycle lanes and sidewalks meet the qualifying criteria stated in the first and third bullets above. Additionally, the proposed development will connect west-side sidewalk to an existing pedestrian path and complete a continuous pedestrian connection between the development site and George Fox University. These multimodal improvements are sufficient to mitigate any minor increase in v/c ratio at the Villa Road/OR 99W intersection. Therefore, no additional mitigation measures are proposed for this intersection.

TRANSPORTATION PLANNING RULE COMPLIANCE

OAR Section 660-12-0060 Plan and Land Use Regulation Amendments of the TPR sets forth the criteria for evaluating plan and land use regulation amendments. The criteria establish the determination of significant effect on a transportation system resulting from a land use action; where a significant affect is identified, the criteria establish the means for achieving compliance. The relevant portion of this section of the TPR is reproduced below in *italics* followed by the response for this project in standard text.

660-12-0060 Plan and Land Use Regulation Amendments

(1) If an amendment to a functional plan, an acknowledged comprehensive plan, or a land use regulation (including a zoning map) would significantly affect an existing or planned transportation facility, then the local government must put in place measures as provided in section (2) of this rule, unless the amendment is allowed under section (3), (9) or (10) of this rule. A plan or land use regulation amendment significantly affects a transportation facility if it would:

(a) Change the functional classification of an existing or planned transportation facility (exclusive of correction of map errors in an adopted plan);

Response: The proposed rezone will not require or result in any changes to the functional classification of any transportation facility in the vicinity of the site.

(b) Change standards implementing a functional classification system; or

Response: The proposed rezone will not require or result in any changes to the standards that implement the functional classification system.

(c) Result in any of the effects listed in paragraphs (A) through (C) of this subsection based on projected conditions measured at the end of the planning period identified in the adopted TSP. As part of evaluating projected conditions, the amount of traffic projected to be generated within the area of the amendment may be reduced if the amendment includes an enforceable, ongoing requirement that would demonstrably limit traffic generation, including, but not limited to, transportation demand management. This reduction may diminish or completely eliminate the significant effect of the amendment.

(A) Types or levels of travel or access that are inconsistent with the functional classification of an existing or planned transportation facility;

Response: The proposed zoning designation would result in future traffic volumes that are consistent with the functional classifications of the roadways in the study area.

*(B) Degrade the performance of an existing or planned transportation facility such that it would not meet the performance standards identified in the TSP or comprehensive plan;
or*

Response: The Villa Road/Fulton Street and Villa Road/OR 99W intersections are not forecast to meet performance standards under 2035 background conditions, without the proposed rezone. Measures to ensure compliance with the TPR are documented in the next section. All other study intersections are forecast to meet performance standards.

(C) Degrade the performance of an existing or planned transportation facility that is otherwise projected to not meet the performance standards identified in the TSP or comprehensive plan.

Response: The following measures are proposed to ensure compliance with this section of the TPR:

Villa Road and Fulton Street

As described previously, all-way stop control is recommended for this intersection to mitigate the significant effect caused by the proposed zone change. This improvement will enhance intersection operations from LOS "F" to LOS "E" during the 2035 weekday p.m. peak hour. This represents a better level of service than under 2035 background traffic conditions.

Villa Road and OR 99W

Action 1F.5 of the *Oregon Highway Plan* states that small increases in traffic, up to 400 ADT, do not cause "further degradation" of state highway facilities. Although the proposed zone change could generate an additional 795 daily trips over current zoning potential, less than 400 of these trips are anticipated to reach the Villa Road/OR 99W intersection.

Finally, Action 1F.5 allows for capacity increasing improvements that include system connectivity improvements (for vehicles, bicycles and pedestrians) and multi-modal opportunities to reduce vehicle demand. The pedestrian and bicycle improvements proposed with the development along Villa Road and the desired completion of a continuous pedestrian route from the rezone site to George Fox University will sufficiently mitigate the small increase in v/c ratio forecast the Villa Road/OR 99W intersection.

ON-SITE CIRCULATION/SITE-ACCESS OPERATIONS

Internal circulation was evaluated to ensure that the site provides sufficient on-site circulation for pedestrian movements and internal traffic. As identified in the proposed site plan in Figure 2, access to the proposed development will occur from a driveway to Villa Road and two accesses to Park Lane. The access to Villa Road is intended to reduce impacts and cut-through traffic to the existing neighborhood to the west. All proposed accesses are anticipated to function acceptably under stop-control.

Vehicle queuing needs were evaluated at the proposed site accesses to Villa Road. Under year 2035 total traffic conditions, the 95th percentile vehicle queues exiting the site were forecast to be less than 25 feet during the weekday p.m. peak hour. Additionally, the southbound right-turn and northbound left-turn queues entering the site from Villa Road were forecast to be less than 25 feet during the same period. *The queuing analysis results are included with the associated LOS worksheets.*

Per Newberg Municipal Code section 15.505.200, access spacing standards are based on the functional classification of the roadways. Access to minor collectors, such as Villa Road, must be at least 150 feet from the nearest public intersections and access to local streets, such as Park Lane, must be at least 100 feet from the nearest public intersection. Additional accesses must be located at least 75 feet from the initial access for both minor collectors and local streets. All proposed access points to adjacent streets as shown in Figure 2 are in compliance with these spacing requirements.

No permanent obstruction to sight lines exists on Park Lane along the proposed site frontage. Shrubbery, trees, other landscaping along the site frontage should be planned and maintained in a manner that does not obstruct sight distance.

Based on a field visit and aerial photography, the current horizontal alignment of Villa Road is not anticipated to interfere with achieving adequate intersection sight distance (ISD) from the proposed site driveway, based on AASHTO standards (Reference xx). Figure 12 show the available ISD based on the existing horizontal alignment. The existing vertical alignment of Villa Road, however, does obstruct ISD at the proposed site access to Villa Road looking south towards to the railroad trestle. Therefore, as part of the proposed development's site frontage design plan, the vertical profile of Villa Road should be redesigned so that adequate ISD is provided for the roadway design speed. Alternatively, the access could be redesigned as a right-in/right-out access. Additionally, landscaping along the Villa Road site frontage should be planned and maintained in a manner that does not obstruct sight distance.



H:\projfiles\18152 - Villa Road Apartments\dwgs\18152_figs.dwg Feb 26, 2015 - 9:15am - sbussey Layout Tab: 14

HORIZONTAL INTERSECTION SIGHT DISTANCE
PROPOSED SITE ACCESS
NEWBERG, OREGON

FIGURE
12

Section 5 Conclusions and Recommendations

CONCLUSIONS AND RECOMMENDATIONS

The results of this traffic impact analysis report indicate that with recommended mitigation measures in place, the proposed site rezone will comply with the State's Transportation Planning Rule by not materially degrading the long-term operations of existing and planned transportation network. In addition, this report demonstrates that the construction of the Martell Commons apartment complex can be achieved while maintaining acceptable levels of service and safety on the surrounding transportation system for the build-out year, with recommended mitigation measures in place. The findings of this analysis and our recommendations are summarized below.

Existing Conditions

- All of the study intersections currently operate at acceptable levels of service during the weekday a.m. and p.m. peak hours.
- A review of crash history did not reveal any patterns at study intersections that require mitigation associated with this project.

Year 2016 Background Traffic Conditions

- All of the study intersections are forecast to continue meeting operational standards during the weekday a.m. peak hour.
- All of the study intersections, except the Villa Road/OR 99W intersection, are forecast to continue meeting operational standards during the weekday p.m. peak hour.
 - The Villa Road/OR 99W intersection is forecast to operate with a v/c ratio of 0.88 in the p.m. peak hour which exceeds the ODOT mobility standard of 0.85.

Proposed Development Plan

- The actual proposed site development for the Martell Commons complex will consist of up to 128 apartment units. This is estimated to conservatively generate 899 average daily trips, 66 trips (13 inbound, 53 outbound) during the weekday a.m. peak hour, and 88 trips (57 inbound, 31 outbound) during the weekday p.m. peak hour.

Year 2016 Total Traffic Conditions

- All of the study intersections, including the proposed site access to Villa Road, are forecast to meet operational standards during the weekday a.m. peak hour.
- All of the study intersections, except the Villa Road/OR 99W intersection, are forecast to meet operational standards during the weekday p.m. peak hour.

- As under background traffic conditions, the Villa Road/OR 99W intersection is forecast to continue to operate with a v/c ratio of 0.88 during the p.m. peak hour which exceeds the ODOT standard of 0.85.

Year 2035 Background Traffic Conditions

- All of the study intersections except the except the Villa Road/OR 99W intersection and Villa Road/Fulton Street intersection are forecast to meet operational standards during the weekday p.m. peak hour.
 - The Villa Road/OR 99W intersection is forecast to operate with a v/c ratio of 1.11 which exceeds the ODOT standard of 0.85.
 - The Villa Road/Fulton Street intersection is forecast to operate with at LOS F which exceeds the City's standard of LOS D or better.

Year 2035 Total Traffic Conditions

- With no off-site mitigation measures, all of the study intersections except the Villa Road/OR 99W intersection and Villa Road/Fulton Street intersection are forecast to continue meeting operational standards during the weekday p.m. peak hour.
 - The Villa Road/OR 99W intersection is forecast to operate with a v/c ratio of 1.12 which is an increase of 0.01 from background conditions and exceeds the ODOT standard of 0.85.
 - The Villa Road/Fulton Street intersection is forecast to continue operating at LOS F which exceeds the City's standard of LOS D or better.

Mitigation Measures

- The proposed Martell Commons development will provide multimodal improvements along Villa Road by adding pedestrian facilities and bicycle lanes on one or both sides of the roadway along the site frontage. Additionally, through additional coordination efforts, the developer desires to connect the sidewalk facilities along the site frontage to an existing pedestrian path to complete a continuous pedestrian/bicycle link between the development site and George Fox University to the south. These multimodal improvements are sufficient to mitigate the minor increase in v/c ratio generated by the development at the Villa Road/OR 99W intersection.
- The Villa Road/Fulton Street intersection should be modified to all-way stop control. This would allow the intersection to operate at LOS E, representing an improvement over year 2035 background conditions without the site development.

On-Site Circulation/Site Access Operations

- All of the proposed external site access points at Park Lane and to Villa Road will function acceptably with stop control on the minor driveway approaches.
- The vertical and horizontal alignments of the proposed full-street improvements along the Villa Road site frontage should be designed to provide adequate intersection sight distance from the proposed site access driveway.
- Shrubbery and landscaping near the site access points should be maintained to ensure adequate intersection sight distance at both site driveways to Villa Road and Park Lane.

Section 6
References

REFERENCES

1. DKS Associates, Inc. *City of Newberg Transportation System Plan Update (DRAFT Future Needs Analysis)*. November 1, 2013.
2. Transportation Research Board. *Highway Capacity Manual*. 2000.
3. Transportation Research Board. *Highway Capacity Manual*. 2010.
4. Oregon Department of Transportation, *Oregon Highway Plan*. 2011 Update.
5. Institute of Transportation Engineers. *9th Edition, Trip Generation Manual*. 2012.
6. Kittelson & Associates, Inc. *Newberg Transportation System Plan*. June 2005.

Appendix A
Traffic Count Data

Type of peak hour being reported: User-Defined

Method for determining peak hour: Total Entering Volume

LOCATION: Aldersgate Ln -- E Crestview Dr
CITY/STATE: Newberg, OR

QC JOB #: 12789209
DATE: Thu, Sep 11 2014

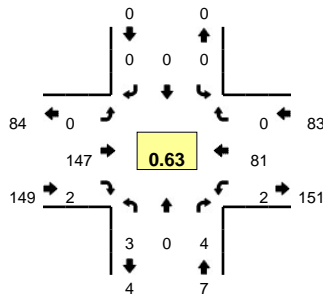

Peak-Hour: 7:05 AM -- 8:05 AM
Peak 15-Min: 7:15 AM -- 7:30 AM

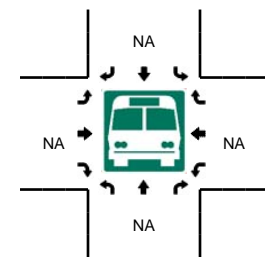
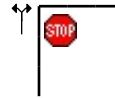
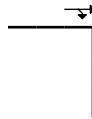
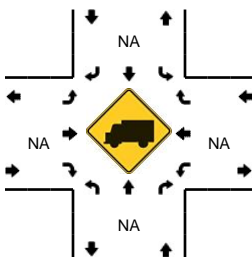
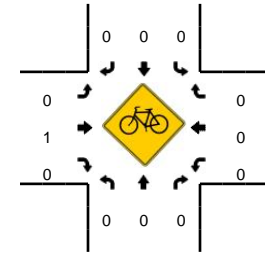
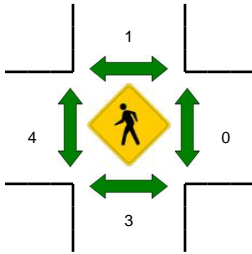
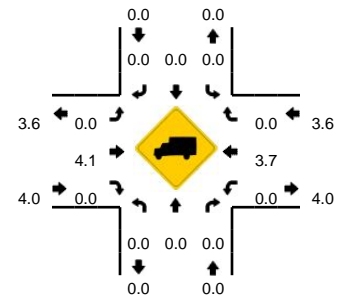

5-Min Count Period Beginning At	Aldersgate Ln (Northbound)				Aldersgate Ln (Southbound)				E Crestview Dr (Eastbound)				E Crestview Dr (Westbound)				Total	Hourly Totals
	Left	Thru	Right	U	Left	Thru	Right	U	Left	Thru	Right	U	Left	Thru	Right	U		
7:00 AM	0	0	1	0	0	0	0	0	0	5	0	0	0	1	0	0	7	
7:05 AM	0	0	1	0	0	0	0	0	0	12	0	0	1	6	0	0	20	
7:10 AM	0	0	0	0	0	0	0	0	0	11	0	0	0	2	0	0	13	
7:15 AM	0	0	1	0	0	0	0	0	0	26	2	0	0	5	0	0	34	
7:20 AM	0	0	0	0	0	0	0	0	0	23	0	0	1	5	0	0	29	
7:25 AM	1	0	0	0	0	0	0	0	0	21	0	0	0	10	0	0	32	
7:30 AM	1	0	1	0	0	0	0	0	0	15	0	0	0	8	0	0	25	
7:35 AM	0	0	0	0	0	0	0	0	0	8	0	0	0	13	0	0	21	
7:40 AM	0	0	0	0	0	0	0	0	0	8	0	0	0	7	0	0	15	
7:45 AM	0	0	1	0	0	0	0	0	0	6	0	0	0	5	0	0	12	
7:50 AM	0	0	0	0	0	0	0	0	0	1	0	0	0	8	0	0	9	
7:55 AM	1	0	0	0	0	0	0	0	0	9	0	0	0	3	0	0	13	230
8:00 AM	0	0	0	0	0	0	0	0	0	7	0	0	0	9	0	0	16	239
8:05 AM	0	0	0	0	0	0	0	0	0	2	0	0	0	9	0	0	11	230
8:10 AM	0	0	0	0	0	0	0	0	0	6	0	0	0	8	0	0	14	231
8:15 AM	0	0	0	0	0	0	0	0	0	8	0	0	0	11	0	0	19	216
8:20 AM	0	0	1	0	0	0	0	0	0	13	0	0	0	2	0	0	16	203
8:25 AM	0	0	1	0	0	0	0	0	0	7	0	0	0	4	0	0	12	183
8:30 AM	0	0	0	0	0	0	0	0	0	9	0	0	0	8	0	0	17	175
8:35 AM	0	0	0	0	0	0	0	0	0	4	0	0	0	1	0	0	5	159
8:40 AM	0	0	0	0	0	0	0	0	0	5	0	0	0	3	0	0	8	152
8:45 AM	0	0	0	0	0	0	0	0	0	7	0	0	0	3	0	0	10	150
8:50 AM	0	0	0	0	0	0	0	0	0	7	0	0	0	5	0	0	12	153
8:55 AM	0	0	0	0	0	0	0	0	0	6	0	0	0	4	0	0	10	150
Peak 15-Min Flowrates	Northbound				Southbound				Eastbound				Westbound				Total	
All Vehicles	4	0	4	0	0	0	0	0	0	280	8	0	4	80	0	0	380	
Heavy Trucks	0	0	0	0	0	0	0	0	0	8	0	0	0	0	0	0	8	
Pedestrians	0	0	0	0	0	4	0	0	0	8	0	0	0	0	0	0	12	
Bicycles	0	0	0	0	0	0	0	0	0	1	0	0	0	0	0	0	1	
Railroad																		
Stopped Buses																		

Comments:

Type of peak hour being reported: User-Defined

Method for determining peak hour: Total Entering Volume

LOCATION: Aldersgate Ln -- Park Ln
CITY/STATE: Newberg, OR

QC JOB #: 12789207
DATE: Thu, Sep 11 2014

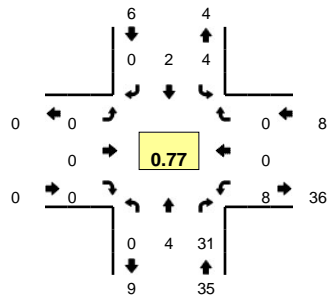

Peak-Hour: 7:05 AM -- 8:05 AM
Peak 15-Min: 7:15 AM -- 7:30 AM

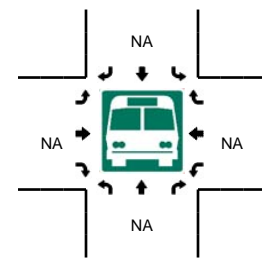
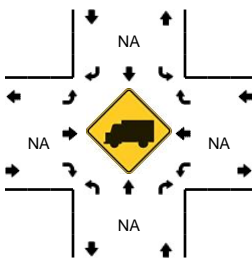
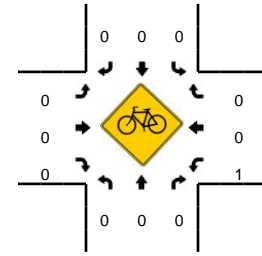
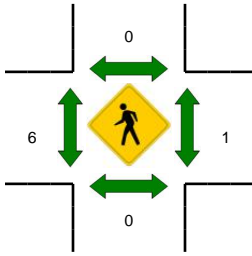
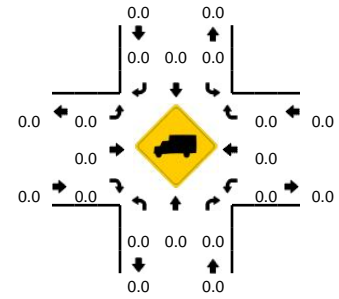

5-Min Count Period Beginning At	Aldersgate Ln (Northbound)				Aldersgate Ln (Southbound)				Park Ln (Eastbound)				Park Ln (Westbound)				Total	Hourly Totals
	Left	Thru	Right	U	Left	Thru	Right	U	Left	Thru	Right	U	Left	Thru	Right	U		
7:00 AM	0	1	1	0	0	0	0	0	0	0	0	0	0	0	0	0	2	
7:05 AM	0	0	3	0	0	1	0	0	0	0	0	0	2	0	0	0	6	
7:10 AM	0	0	1	0	0	0	0	0	0	0	0	0	0	0	0	0	1	
7:15 AM	0	1	3	0	2	0	0	0	0	0	0	0	1	0	0	0	7	
7:20 AM	0	1	3	0	0	0	0	0	0	0	0	0	0	0	0	0	4	
7:25 AM	0	1	3	0	0	0	0	0	0	0	0	0	1	0	0	0	5	
7:30 AM	0	0	4	0	0	0	0	0	0	0	0	0	2	0	0	0	6	
7:35 AM	0	0	3	0	1	1	0	0	0	0	0	0	0	0	0	0	5	
7:40 AM	0	0	4	0	0	0	0	0	0	0	0	0	1	0	0	0	5	
7:45 AM	0	1	2	0	0	0	0	0	0	0	0	0	0	0	0	0	3	
7:50 AM	0	0	3	0	1	0	0	0	0	0	0	0	0	0	0	0	4	
7:55 AM	0	0	0	0	0	0	0	0	0	0	0	0	0	0	0	0	0	48
8:00 AM	0	0	2	0	0	0	0	0	0	0	0	0	0	0	0	1	3	49
8:05 AM	0	0	2	0	0	0	0	0	0	0	0	0	3	0	1	0	6	49
8:10 AM	0	0	3	0	0	0	0	0	0	0	0	0	1	0	0	0	4	52
8:15 AM	0	0	4	0	1	0	0	0	0	0	0	0	0	0	0	0	5	50
8:20 AM	0	1	1	0	0	0	0	0	0	0	0	0	1	0	0	0	3	49
8:25 AM	0	0	4	0	1	0	0	0	0	0	0	0	0	0	0	0	5	49
8:30 AM	0	0	1	0	0	0	0	0	0	0	0	0	0	0	0	0	1	44
8:35 AM	0	0	0	0	0	0	0	0	0	0	0	0	1	0	0	0	1	40
8:40 AM	0	1	1	0	1	0	0	0	0	0	0	0	1	0	0	0	4	39
8:45 AM	0	0	1	0	1	0	0	0	0	0	0	0	0	0	0	0	2	38
8:50 AM	0	0	0	0	0	0	0	0	0	0	0	0	1	0	0	0	1	35
8:55 AM	0	0	1	0	0	0	0	0	0	0	0	0	1	0	0	0	2	37
Peak 15-Min Flowrates	Northbound				Southbound				Eastbound				Westbound				Total	
	Left	Thru	Right	U	Left	Thru	Right	U	Left	Thru	Right	U	Left	Thru	Right	U		
All Vehicles	0	12	36	0	8	0	0	0	0	0	0	0	8	0	0	0	64	
Heavy Trucks	0	0	0	0	0	0	0	0	0	0	0	0	0	0	0	0	0	
Pedestrians	0	0	0	0	0	0	0	0	0	4	0	0	0	0	0	0	4	
Bicycles	0	0	0	0	0	0	0	0	0	0	0	0	0	0	0	0	0	
Railroad																		
Stopped Buses																		

Comments:

Type of peak hour being reported: User-Defined

Method for determining peak hour: Total Entering Volume

LOCATION: Villa Rd -- Park Ln
CITY/STATE: Newberg, OR

QC JOB #: 12789205
DATE: Thu, Sep 11 2014

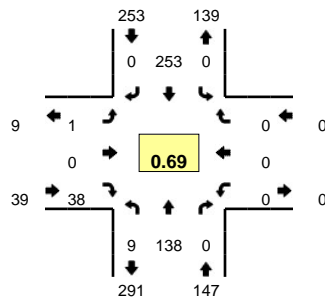

Peak-Hour: 7:05 AM -- 8:05 AM
Peak 15-Min: 7:15 AM -- 7:30 AM

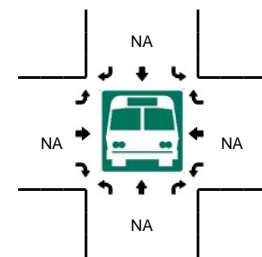
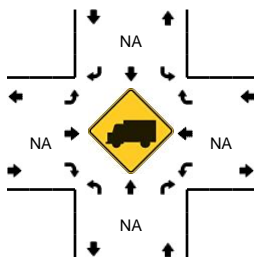
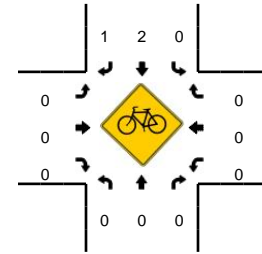
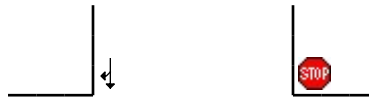
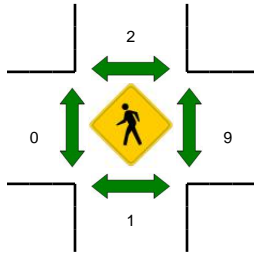
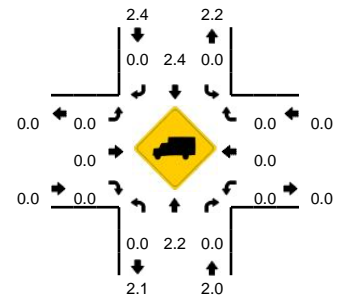

5-Min Count Period Beginning At	Villa Rd (Northbound)				Villa Rd (Southbound)				Park Ln (Eastbound)				Park Ln (Westbound)				Total	Hourly Totals
	Left	Thru	Right	U	Left	Thru	Right	U	Left	Thru	Right	U	Left	Thru	Right	U		
7:00 AM	0	3	0	0	0	15	0	0	0	0	2	0	0	0	0	0	20	
7:05 AM	1	7	0	0	0	22	0	0	0	0	1	0	0	0	0	0	31	
7:10 AM	0	5	0	0	0	23	0	0	0	0	3	0	0	0	0	0	31	
7:15 AM	1	7	0	0	0	37	0	0	1	0	3	0	0	0	0	0	49	
7:20 AM	1	15	0	0	0	34	0	0	0	0	7	0	0	0	0	0	57	
7:25 AM	1	21	0	0	0	29	0	0	0	0	3	0	0	0	0	0	54	
7:30 AM	2	11	0	0	0	30	0	0	0	0	5	0	0	0	0	0	48	
7:35 AM	0	18	0	0	0	18	0	0	0	0	3	0	0	0	0	0	39	
7:40 AM	2	8	0	0	0	16	0	0	0	0	6	0	0	0	0	0	32	
7:45 AM	0	12	0	0	0	9	0	0	0	0	2	0	0	0	0	0	23	
7:50 AM	0	7	0	0	0	11	0	0	0	0	2	0	0	0	0	0	20	
7:55 AM	0	12	0	0	0	14	0	0	0	0	1	0	0	0	0	0	27	431
8:00 AM	1	15	0	0	0	10	0	0	0	0	2	0	0	0	0	0	28	439
8:05 AM	3	10	0	0	0	17	0	0	0	0	4	0	0	0	0	0	34	442
8:10 AM	2	14	0	0	0	7	0	0	0	0	3	0	0	0	0	0	26	437
8:15 AM	0	10	0	0	0	12	0	0	0	0	3	0	0	0	0	0	25	413
8:20 AM	1	7	0	0	0	19	0	0	1	0	3	0	0	0	0	0	31	387
8:25 AM	0	9	0	0	0	14	0	0	0	0	5	0	0	0	0	0	28	361
8:30 AM	0	13	0	0	0	15	0	0	0	0	2	0	0	0	0	0	30	343
8:35 AM	1	4	0	0	0	12	0	0	0	0	0	0	0	0	0	0	17	321
8:40 AM	1	10	0	0	0	14	0	0	0	0	3	0	0	0	0	0	28	317
8:45 AM	0	8	0	0	0	15	0	0	0	0	2	0	0	0	0	0	25	319
8:50 AM	1	8	0	0	0	23	0	0	0	0	0	0	0	0	0	0	32	331
8:55 AM	1	12	0	0	0	18	0	0	0	0	1	0	0	0	0	0	32	336
Peak 15-Min Flowrates	Northbound				Southbound				Eastbound				Westbound				Total	
	Left	Thru	Right	U	Left	Thru	Right	U	Left	Thru	Right	U	Left	Thru	Right	U		
All Vehicles	12	172	0	0	0	400	0	0	4	0	52	0	0	0	0	0	640	
Heavy Trucks	0	0	0	0	0	4	0	0	0	0	0	0	0	0	0	0	4	
Pedestrians		0				0					0			12			12	
Bicycles	0	0	0		0	1	0		0	0	0		0	0	0		1	
Railroad																		
Stopped Buses																		

Comments:

Type of peak hour being reported: User-Defined

Method for determining peak hour: Total Entering Volume

LOCATION: Villa Rd -- Fulton St
CITY/STATE: Newberg, OR

QC JOB #: 12789203
DATE: Thu, Sep 11 2014

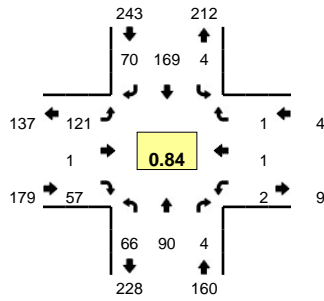

Peak-Hour: 7:05 AM -- 8:05 AM
Peak 15-Min: 7:45 AM -- 8:00 AM

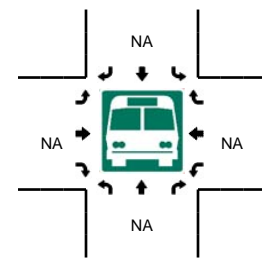
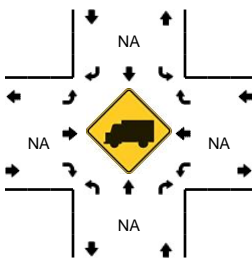
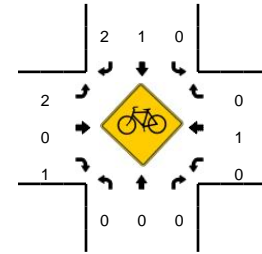
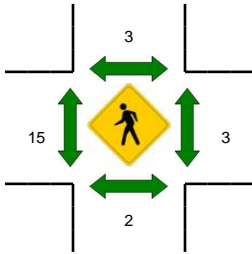
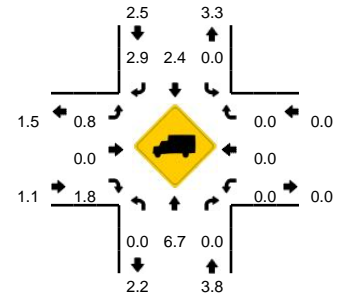

5-Min Count Period Beginning At	Villa Rd (Northbound)				Villa Rd (Southbound)				Fulton St (Eastbound)				Fulton St (Westbound)				Total	Hourly Totals
	Left	Thru	Right	U	Left	Thru	Right	U	Left	Thru	Right	U	Left	Thru	Right	U		
7:00 AM	1	6	1	0	0	13	1	0	9	1	4	0	0	0	0	0	36	
7:05 AM	3	3	0	0	0	17	4	0	12	0	9	0	0	0	0	0	48	
7:10 AM	0	3	0	0	0	13	3	0	16	0	7	0	1	0	0	0	43	
7:15 AM	3	6	0	0	0	11	0	0	17	0	4	0	0	0	0	0	41	
7:20 AM	1	14	1	0	0	17	5	0	12	0	5	0	0	0	0	0	55	
7:25 AM	3	13	0	0	1	18	5	0	7	0	5	0	0	0	0	0	52	
7:30 AM	4	8	0	0	1	20	9	0	17	0	5	0	0	0	1	0	65	
7:35 AM	3	6	0	0	0	13	7	0	10	0	4	0	0	0	0	0	43	
7:40 AM	7	6	0	0	2	12	9	0	7	0	3	0	0	0	0	0	46	
7:45 AM	16	9	0	0	0	11	8	0	3	0	3	0	0	0	0	0	50	
7:50 AM	11	6	1	0	0	19	15	0	9	1	7	0	0	0	0	0	69	
7:55 AM	10	12	1	0	0	12	4	0	10	0	4	0	1	1	0	0	55	603
8:00 AM	5	4	1	0	0	6	1	0	1	0	1	0	0	0	0	0	19	586
8:05 AM	1	2	0	0	0	6	0	0	1	0	3	0	0	0	0	0	13	551
8:10 AM	12	15	1	0	0	14	2	0	5	0	4	0	0	0	0	0	53	561
8:15 AM	7	8	1	0	0	15	5	0	5	0	7	0	1	0	1	0	50	570
8:20 AM	5	10	1	0	0	17	6	0	3	0	9	0	0	0	0	0	51	566
8:25 AM	5	11	1	0	1	17	2	0	4	0	6	0	1	0	0	0	48	562
8:30 AM	7	11	0	0	0	14	5	0	4	0	5	0	0	0	0	0	46	543
8:35 AM	1	4	2	0	0	8	6	0	5	0	7	0	0	0	0	0	33	533
8:40 AM	6	10	0	0	0	14	2	0	2	0	4	0	0	0	0	0	38	525
8:45 AM	6	8	1	0	0	21	6	0	3	0	9	0	0	0	0	0	54	529
8:50 AM	6	9	1	0	0	21	3	0	9	0	10	0	1	0	0	0	60	520
8:55 AM	14	15	1	0	0	19	3	0	5	0	5	0	1	0	0	0	63	528
Peak 15-Min Flowrates	Northbound				Southbound				Eastbound				Westbound				Total	
	Left	Thru	Right	U	Left	Thru	Right	U	Left	Thru	Right	U	Left	Thru	Right	U		
All Vehicles	148	108	8	0	0	168	108	0	88	4	56	0	4	4	0	0	696	
Heavy Trucks	0	8	0	0	0	8	0	0	0	0	0	0	0	0	0	0	16	
Pedestrians	0	0	0	0	0	0	0	0	24	0	0	0	0	0	0	0	24	
Bicycles	0	0	0	0	0	1	1	0	0	0	1	0	0	1	0	0	4	
Railroad																		
Stopped Buses																		

Comments:

Type of peak hour being reported: User-Defined

Method for determining peak hour: Total Entering Volume

LOCATION: Villa Rd -- Hwy 99W
CITY/STATE: Newberg, OR

QC JOB #: 12789201
DATE: Thu, Sep 11 2014

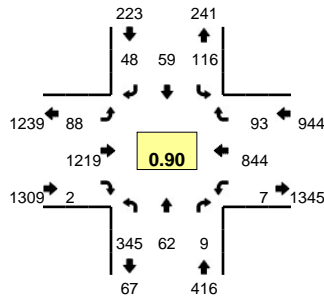

Peak-Hour: 7:05 AM -- 8:05 AM
Peak 15-Min: 7:35 AM -- 7:50 AM

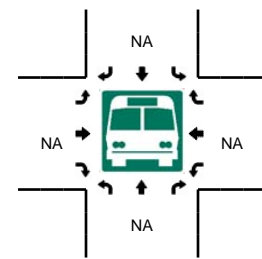
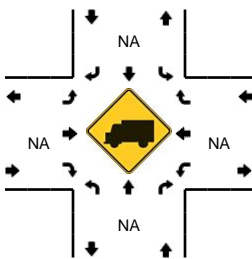
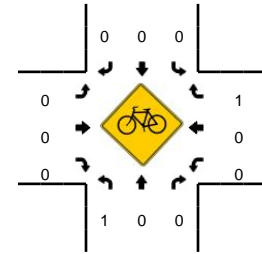
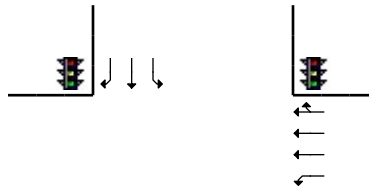
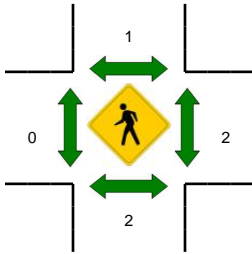
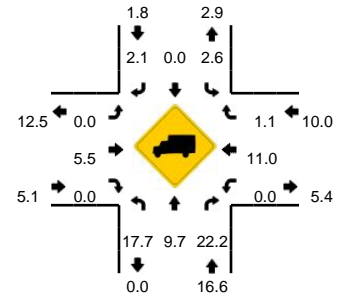

5-Min Count Period Beginning At	Villa Rd (Northbound)				Villa Rd (Southbound)				Hwy 99W (Eastbound)				Hwy 99W (Westbound)				Total	Hourly Totals
	Left	Thru	Right	U	Left	Thru	Right	U	Left	Thru	Right	U	Left	Thru	Right	U		
7:00 AM	21	7	1	0	3	4	3	0	12	108	0	0	0	51	4	0	214	
7:05 AM	18	4	2	0	18	4	2	0	5	110	0	0	0	69	2	0	234	
7:10 AM	26	3	1	0	14	7	1	0	3	118	0	0	0	49	4	0	226	
7:15 AM	14	4	1	0	7	5	1	0	9	104	0	0	0	59	1	0	205	
7:20 AM	21	3	0	0	12	3	3	0	6	97	0	0	0	65	6	0	216	
7:25 AM	23	1	0	0	8	8	3	0	3	117	0	0	2	71	8	1	245	
7:30 AM	32	3	0	0	13	7	7	0	5	110	0	0	0	76	5	0	258	
7:35 AM	36	4	1	0	9	3	7	0	6	122	0	0	2	104	6	0	300	
7:40 AM	32	10	2	0	8	5	4	0	5	96	1	0	1	70	8	0	242	
7:45 AM	50	8	1	0	9	7	4	0	8	89	1	0	0	74	12	0	263	
7:50 AM	29	8	1	0	4	3	5	0	18	93	0	0	0	80	18	0	259	
7:55 AM	32	9	0	0	9	4	6	0	7	65	0	2	0	64	15	0	213	2875
8:00 AM	32	5	0	0	5	3	5	0	11	98	0	0	1	63	8	0	231	2892
8:05 AM	43	9	1	0	15	10	16	0	8	83	0	0	1	50	7	0	243	2901
8:10 AM	33	9	0	0	9	3	12	0	6	65	0	1	2	71	10	0	221	2896
8:15 AM	23	5	1	0	8	3	7	0	3	110	0	0	2	76	19	0	257	2948
8:20 AM	16	11	0	0	12	6	11	0	12	88	0	0	1	57	8	0	222	2954
8:25 AM	38	8	1	0	9	9	8	0	10	90	0	1	0	61	14	1	250	2959
8:30 AM	37	10	0	0	11	4	10	0	7	83	0	0	0	65	7	0	234	2935
8:35 AM	38	5	0	0	8	4	6	0	7	84	0	0	4	51	10	0	217	2852
8:40 AM	21	8	1	0	10	1	3	1	5	120	1	0	1	85	6	0	263	2873
8:45 AM	29	8	0	0	8	4	5	0	16	100	0	0	0	59	12	0	241	2851
8:50 AM	41	6	0	0	24	8	12	0	8	87	1	0	2	59	11	0	259	2851
8:55 AM	24	13	1	0	7	6	3	0	9	81	0	1	0	65	10	0	220	2858
Peak 15-Min Flowrates	Northbound				Southbound				Eastbound				Westbound				Total	
	Left	Thru	Right	U	Left	Thru	Right	U	Left	Thru	Right	U	Left	Thru	Right	U		
All Vehicles	472	88	16	0	104	60	60	0	76	1228	8	0	12	992	104	0	3220	
Heavy Trucks	64	8	0		0	0	4		0	80	0		0	96	0		252	
Pedestrians		4				0				0				0			4	
Bicycles		0	0			0	0			0	0			0	0		0	
Railroad																		
Stopped Buses																		

Comments:

Type of peak hour being reported: System Peak

Method for determining peak hour: Total Entering Volume

LOCATION: Aldersgate Ln -- E Crestview Dr
CITY/STATE: Newberg, OR

QC JOB #: 12789210
DATE: Wed, Sep 10 2014

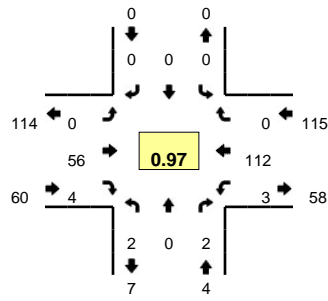

Peak-Hour: 5:00 PM -- 6:00 PM
Peak 15-Min: 5:05 PM -- 5:20 PM

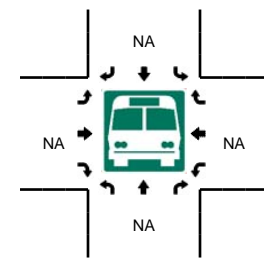
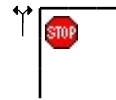
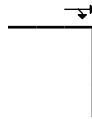
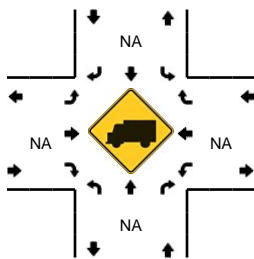
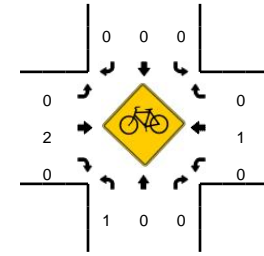
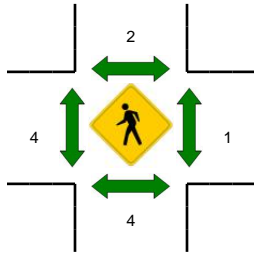
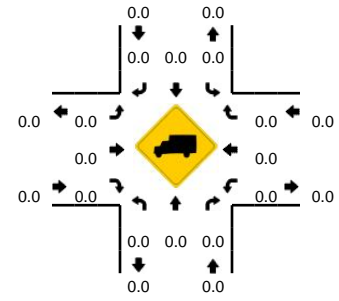

5-Min Count Period Beginning At	Aldersgate Ln (Northbound)				Aldersgate Ln (Southbound)				E Crestview Dr (Eastbound)				E Crestview Dr (Westbound)				Total	Hourly Totals
	Left	Thru	Right	U	Left	Thru	Right	U	Left	Thru	Right	U	Left	Thru	Right	U		
4:00 PM	0	0	0	0	0	0	0	0	0	5	0	0	0	5	0	0	10	
4:05 PM	0	0	0	0	0	0	0	0	0	2	0	0	0	10	0	0	12	
4:10 PM	0	0	0	0	0	0	0	0	0	3	0	0	0	15	0	0	18	
4:15 PM	0	0	0	0	0	0	0	0	0	3	0	0	0	11	0	0	14	
4:20 PM	0	0	0	0	0	0	0	0	0	2	1	0	0	6	0	0	9	
4:25 PM	0	0	0	0	0	0	0	0	0	0	0	0	1	9	0	0	10	
4:30 PM	0	0	0	0	0	0	0	0	0	4	0	0	0	9	0	0	13	
4:35 PM	1	0	0	0	0	0	0	0	0	10	0	0	0	7	0	0	18	
4:40 PM	0	0	0	0	0	0	0	0	0	2	1	0	2	9	0	0	14	
4:45 PM	0	0	1	0	0	0	0	0	0	4	0	0	3	6	0	0	14	
4:50 PM	0	0	0	0	0	0	0	0	0	5	0	0	0	8	0	0	13	
4:55 PM	0	0	0	0	0	0	0	0	0	3	0	0	0	11	0	0	14	159
5:00 PM	0	0	2	0	0	0	0	0	0	7	1	0	0	9	0	0	19	168
5:05 PM	0	0	0	0	0	0	0	0	0	3	0	0	1	4	0	0	8	164
5:10 PM	0	0	0	0	0	0	0	0	0	4	0	0	0	16	0	0	20	166
5:15 PM	0	0	0	0	0	0	0	0	0	6	0	0	0	12	0	0	18	170
5:20 PM	0	0	0	0	0	0	0	0	0	3	0	0	0	13	0	0	16	177
5:25 PM	0	0	0	0	0	0	0	0	0	7	1	0	0	7	0	0	15	182
5:30 PM	0	0	0	0	0	0	0	0	0	4	0	0	1	6	0	0	11	180
5:35 PM	0	0	0	0	0	0	0	0	0	5	0	0	0	10	0	0	15	177
5:40 PM	1	0	0	0	0	0	0	0	0	3	0	0	0	13	0	0	17	180
5:45 PM	1	0	0	0	0	0	0	0	0	5	0	0	0	6	0	0	12	178
5:50 PM	0	0	0	0	0	0	0	0	0	7	2	0	0	6	0	0	15	180
5:55 PM	0	0	0	0	0	0	0	0	0	2	0	0	1	10	0	0	13	179
Peak 15-Min Flowrates	Northbound				Southbound				Eastbound				Westbound				Total	
	Left	Thru	Right	U	Left	Thru	Right	U	Left	Thru	Right	U	Left	Thru	Right	U		
All Vehicles	0	0	0	0	0	0	0	0	0	52	0	0	4	128	0	0	184	
Heavy Trucks	0	0	0	0	0	0	0	0	0	0	0	0	0	0	0	0	0	
Pedestrians	0	0	0	0	0	0	0	0	0	0	0	0	0	0	0	0	0	
Bicycles	0	0	0	0	0	0	0	0	0	0	0	0	0	0	0	0	0	
Railroad																		
Stopped Buses																		

Comments:

Type of peak hour being reported: System Peak

Method for determining peak hour: Total Entering Volume

LOCATION: Aldersgate Ln -- Park Ln
CITY/STATE: Newberg, OR

QC JOB #: 12789208
DATE: Wed, Sep 10 2014

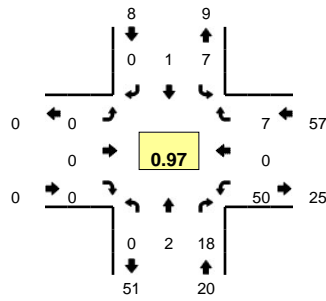

Peak-Hour: 5:00 PM -- 6:00 PM
Peak 15-Min: 5:05 PM -- 5:20 PM

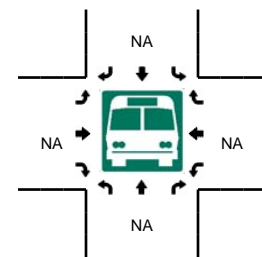
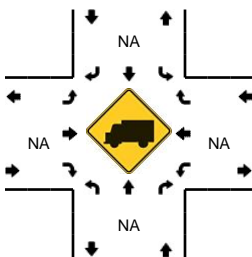
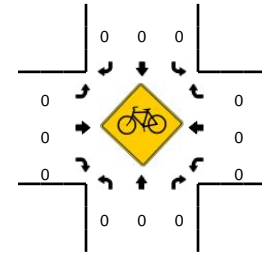
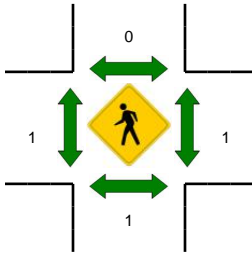
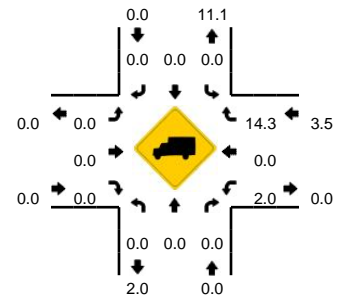

5-Min Count Period Beginning At	Aldersgate Ln (Northbound)				Aldersgate Ln (Southbound)				Park Ln (Eastbound)				Park Ln (Westbound)				Total	Hourly Totals
	Left	Thru	Right	U	Left	Thru	Right	U	Left	Thru	Right	U	Left	Thru	Right	U		
4:00 PM	0	0	1	0	1	0	0	0	0	0	0	0	6	0	0	0	8	
4:05 PM	0	0	1	0	1	0	0	0	0	0	0	0	1	0	1	0	4	
4:10 PM	0	0	1	0	0	0	0	0	0	0	0	0	3	0	0	0	4	
4:15 PM	0	0	1	0	1	0	0	0	0	0	0	0	3	0	2	0	7	
4:20 PM	0	0	2	0	1	0	0	0	0	0	0	0	0	0	0	0	3	
4:25 PM	0	0	2	0	1	0	0	0	0	0	0	0	0	0	0	0	3	
4:30 PM	0	0	1	0	0	0	0	0	0	0	0	0	2	0	0	0	3	
4:35 PM	0	0	0	0	2	0	0	0	0	0	0	0	2	0	1	0	5	
4:40 PM	0	0	4	0	1	1	0	0	0	0	0	0	0	0	2	0	8	
4:45 PM	0	1	4	0	1	3	0	0	0	0	0	0	1	0	0	0	10	
4:50 PM	0	0	2	0	0	0	0	0	0	0	0	0	3	0	1	0	6	
4:55 PM	0	1	4	0	1	0	0	0	0	0	0	0	2	0	1	0	9	70
5:00 PM	0	1	3	0	0	0	0	0	0	0	0	0	1	0	2	0	7	69
5:05 PM	0	0	0	0	0	0	0	0	0	0	0	0	5	0	0	0	5	70
5:10 PM	0	0	2	0	0	0	0	0	0	0	0	0	4	0	1	0	7	73
5:15 PM	0	1	2	0	0	0	0	0	0	0	0	0	6	0	1	0	10	76
5:20 PM	0	0	1	0	0	0	0	0	0	0	0	0	3	0	0	0	4	77
5:25 PM	0	0	2	0	1	0	0	0	0	0	0	0	4	0	0	0	7	81
5:30 PM	0	0	3	0	1	0	0	0	0	0	0	0	3	0	1	0	8	86
5:35 PM	0	0	1	0	1	0	0	0	0	0	0	0	6	0	1	0	9	90
5:40 PM	0	0	2	0	3	0	0	0	0	0	0	0	8	0	0	0	13	95
5:45 PM	0	0	1	0	0	0	0	0	0	0	0	0	1	0	0	0	2	87
5:50 PM	0	0	1	0	1	0	0	0	0	0	0	0	4	0	1	0	7	88
5:55 PM	0	0	0	0	0	1	0	0	0	0	0	0	5	0	0	0	6	85
Peak 15-Min Flowrates	Northbound				Southbound				Eastbound				Westbound				Total	
	Left	Thru	Right	U	Left	Thru	Right	U	Left	Thru	Right	U	Left	Thru	Right	U		
All Vehicles	0	4	16	0	0	0	0	0	0	0	0	0	60	0	8	0	88	
Heavy Trucks	0	0	0	0	0	0	0	0	0	0	0	0	0	0	0	0	0	
Pedestrians	0	0	0	0	0	0	0	0	0	0	0	0	0	0	0	0	0	
Bicycles	0	0	0	0	0	0	0	0	0	0	0	0	0	0	0	0	0	
Railroad																		
Stopped Buses																		

Comments:

Type of peak hour being reported: System Peak

Method for determining peak hour: Total Entering Volume

LOCATION: Villa Rd -- Park Ln
CITY/STATE: Newberg, OR

QC JOB #: 12789206
DATE: Wed, Sep 10 2014

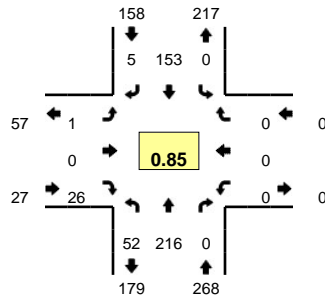

Peak-Hour: 5:00 PM -- 6:00 PM
Peak 15-Min: 5:05 PM -- 5:20 PM

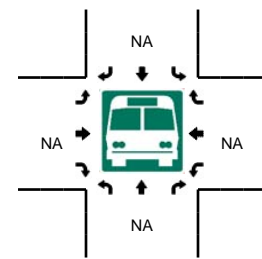
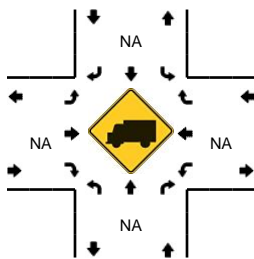
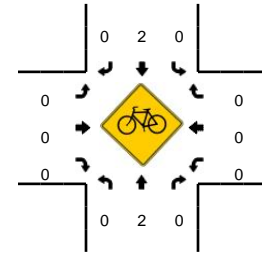
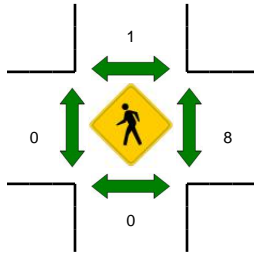
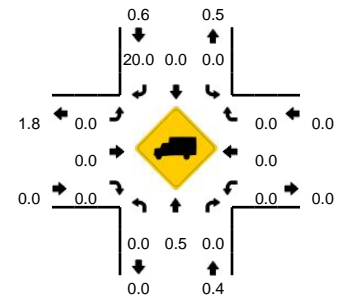

5-Min Count Period Beginning At	Villa Rd (Northbound)				Villa Rd (Southbound)				Park Ln (Eastbound)				Park Ln (Westbound)				Total	Hourly Totals
	Left	Thru	Right	U	Left	Thru	Right	U	Left	Thru	Right	U	Left	Thru	Right	U		
4:00 PM	6	15	0	0	0	9	0	0	1	0	1	0	0	0	0	0	32	
4:05 PM	4	19	0	0	0	9	0	0	0	0	2	0	0	0	0	0	34	
4:10 PM	2	21	0	0	0	10	1	0	0	0	2	0	0	0	0	0	36	
4:15 PM	6	17	0	1	0	7	0	0	0	0	1	0	0	0	0	0	32	
4:20 PM	0	16	0	0	0	9	0	0	0	0	2	0	0	0	0	0	27	
4:25 PM	0	16	0	0	0	6	0	0	1	0	2	0	0	0	0	0	25	
4:30 PM	2	14	0	0	0	13	0	0	0	0	1	0	0	0	0	0	30	
4:35 PM	3	14	0	0	0	19	0	0	0	0	2	0	0	0	0	0	38	
4:40 PM	2	19	0	0	0	19	1	0	0	0	6	0	0	0	0	0	47	
4:45 PM	3	7	0	0	0	12	0	0	1	0	4	0	0	0	0	0	27	
4:50 PM	4	12	0	0	0	8	0	0	0	0	2	0	0	0	0	0	26	
4:55 PM	2	12	0	0	0	4	0	0	1	0	4	0	0	0	0	0	23	377
5:00 PM	4	20	0	0	0	10	0	0	0	0	2	0	0	0	0	0	36	381
5:05 PM	5	18	0	0	0	14	0	0	0	0	2	0	0	0	0	0	39	386
5:10 PM	3	28	0	0	0	17	2	0	0	0	1	0	0	0	0	0	51	401
5:15 PM	9	15	0	0	0	15	1	0	0	0	3	0	0	0	0	0	43	412
5:20 PM	2	22	0	0	0	12	0	0	0	0	2	0	0	0	0	0	38	423
5:25 PM	4	15	0	0	0	17	0	0	0	0	2	0	0	0	0	0	38	436
5:30 PM	3	14	0	0	0	10	1	0	0	0	3	0	0	0	0	0	31	437
5:35 PM	6	18	0	0	0	15	0	0	1	0	1	0	0	0	0	0	41	440
5:40 PM	5	24	0	0	0	6	1	0	0	0	5	0	0	0	0	0	41	434
5:45 PM	2	17	0	0	0	13	0	0	0	0	3	0	0	0	0	0	35	442
5:50 PM	6	10	0	0	0	15	0	0	0	0	2	0	0	0	0	0	33	449
5:55 PM	3	15	0	0	0	9	0	0	0	0	0	0	0	0	0	0	27	453
Peak 15-Min Flowrates	Northbound				Southbound				Eastbound				Westbound				Total	
	Left	Thru	Right	U	Left	Thru	Right	U	Left	Thru	Right	U	Left	Thru	Right	U		
All Vehicles	68	244	0	0	0	184	12	0	0	0	24	0	0	0	0	0	532	
Heavy Trucks	0	0	0	0	0	0	0	0	0	0	0	0	0	0	0	0	0	
Pedestrians		0				0					0			4			4	
Bicycles	0	0	0		0	0	0		0	0	0		0	0	0		0	
Railroad																		
Stopped Buses																		

Comments:

Type of peak hour being reported: System Peak

Method for determining peak hour: Total Entering Volume

LOCATION: Villa Rd -- Fulton St
CITY/STATE: Newberg, OR

QC JOB #: 12789204
DATE: Wed, Sep 10 2014

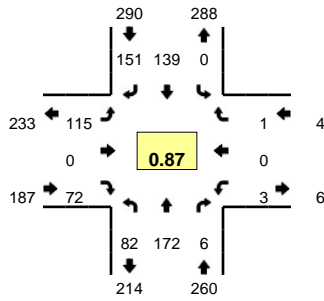

Peak-Hour: 5:00 PM -- 6:00 PM
Peak 15-Min: 5:05 PM -- 5:20 PM

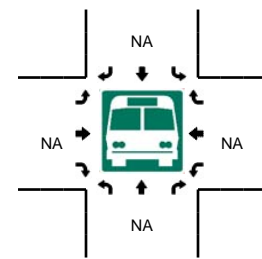
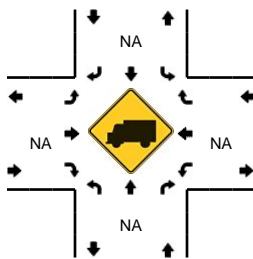
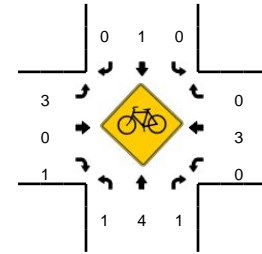
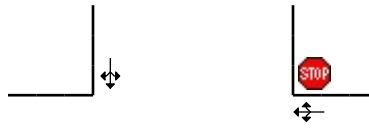
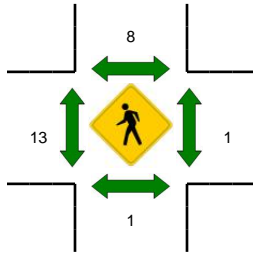
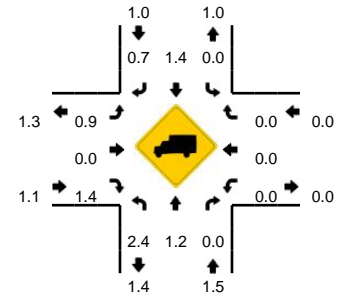

5-Min Count Period Beginning At	Villa Rd (Northbound)				Villa Rd (Southbound)				Fulton St (Eastbound)				Fulton St (Westbound)				Total	Hourly Totals
	Left	Thru	Right	U	Left	Thru	Right	U	Left	Thru	Right	U	Left	Thru	Right	U		
4:00 PM	7	16	0	0	0	11	9	0	4	1	7	0	1	1	1	0	58	
4:05 PM	7	17	0	0	0	11	6	0	8	0	14	0	0	0	0	0	63	
4:10 PM	6	21	0	0	0	8	8	0	5	0	8	0	0	0	0	0	56	
4:15 PM	6	15	0	0	0	10	11	0	9	0	12	0	1	1	0	0	65	
4:20 PM	2	12	1	0	0	8	9	0	7	0	10	0	0	0	0	0	49	
4:25 PM	8	18	2	0	0	5	10	0	8	0	12	0	0	0	1	0	64	
4:30 PM	5	10	1	0	0	15	7	0	6	0	7	0	4	0	0	0	55	
4:35 PM	8	17	0	0	0	16	9	0	6	0	9	0	0	0	0	0	65	
4:40 PM	5	9	1	0	0	10	8	0	11	0	9	0	0	0	0	0	53	
4:45 PM	10	12	2	0	0	14	6	0	6	0	6	0	0	0	0	0	56	
4:50 PM	6	9	0	0	0	15	9	0	9	0	13	0	1	0	0	0	62	
4:55 PM	9	12	0	0	0	11	8	0	12	0	6	0	0	0	1	0	59	705
5:00 PM	8	14	0	0	0	10	9	0	10	0	7	0	0	0	0	0	58	705
5:05 PM	12	18	1	0	0	13	16	0	9	0	7	0	0	0	0	0	76	718
5:10 PM	4	17	1	0	0	12	13	0	10	0	4	0	1	0	1	0	63	725
5:15 PM	2	21	0	0	0	16	11	0	14	0	9	0	1	0	0	0	74	734
5:20 PM	4	13	0	0	0	12	10	0	16	0	10	0	1	0	0	0	66	751
5:25 PM	8	17	0	0	0	11	16	0	11	0	6	0	0	0	0	0	69	756
5:30 PM	5	9	0	0	0	13	15	0	9	0	3	0	0	0	0	0	54	755
5:35 PM	7	11	1	0	0	20	11	0	5	0	3	0	0	0	0	0	58	748
5:40 PM	7	14	0	0	0	7	9	0	13	0	4	0	0	0	0	0	54	749
5:45 PM	6	11	0	0	0	11	12	0	5	0	4	0	0	0	0	0	49	742
5:50 PM	5	12	1	0	0	7	14	0	8	0	7	0	0	0	0	0	54	734
5:55 PM	14	15	2	0	0	7	15	0	5	0	8	0	0	0	0	0	66	741
Peak 15-Min Flowrates	Northbound				Southbound				Eastbound				Westbound				Total	
	Left	Thru	Right	U	Left	Thru	Right	U	Left	Thru	Right	U	Left	Thru	Right	U		
All Vehicles	72	224	8	0	0	164	160	0	132	0	80	0	8	0	4	0	852	
Heavy Trucks	0	0	0	0	0	0	0	0	0	0	0	0	0	0	0	0	0	
Pedestrians		0				8				12				0			20	
Bicycles	0	2	0	0	0	0	0	0	0	0	0	0	0	0	0	0	2	
Railroad																		
Stopped Buses																		

Comments:

Type of peak hour being reported: System Peak

Method for determining peak hour: Total Entering Volume

LOCATION: Villa Rd -- Hwy 99W
CITY/STATE: Newberg, OR

QC JOB #: 12789202
DATE: Wed, Sep 10 2014

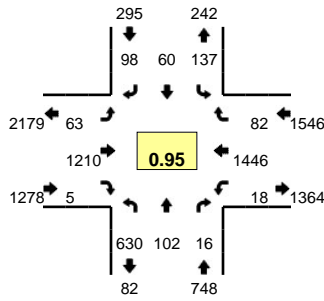

Peak-Hour: 5:00 PM -- 6:00 PM
Peak 15-Min: 5:05 PM -- 5:20 PM

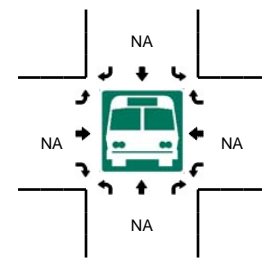
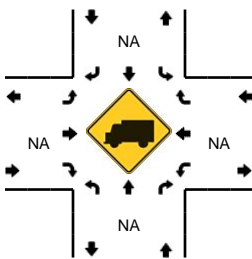
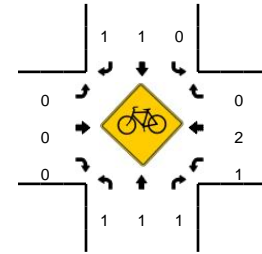
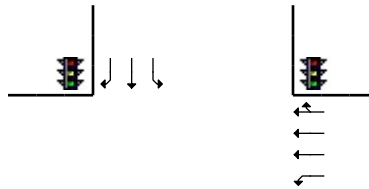
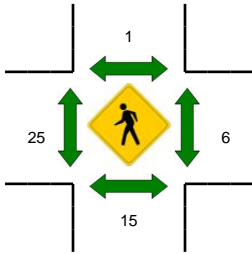
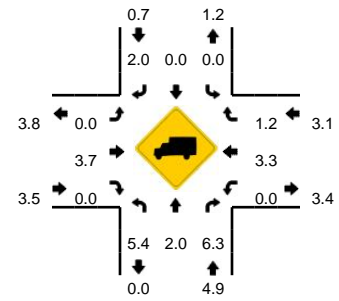

5-Min Count Period Beginning At	Villa Rd (Northbound)				Villa Rd (Southbound)				Hwy 99W (Eastbound)				Hwy 99W (Westbound)				Total	Hourly Totals
	Left	Thru	Right	U	Left	Thru	Right	U	Left	Thru	Right	U	Left	Thru	Right	U		
4:00 PM	46	14	0	0	18	13	17	0	3	83	0	2	1	117	5	0	319	
4:05 PM	54	7	4	0	24	4	8	0	10	99	0	0	1	103	7	0	321	
4:10 PM	47	9	1	0	7	4	8	0	5	100	0	0	2	137	9	0	329	
4:15 PM	46	13	1	0	14	7	8	0	8	96	1	0	0	114	8	0	316	
4:20 PM	39	5	0	0	16	4	3	0	9	83	0	0	1	103	3	0	266	
4:25 PM	54	17	0	0	17	6	3	0	3	112	0	2	2	135	13	0	364	
4:30 PM	32	6	1	0	14	12	9	0	2	90	0	1	1	100	7	0	275	
4:35 PM	67	10	2	0	22	8	13	0	3	73	0	0	1	92	8	0	299	
4:40 PM	32	5	1	0	14	6	2	0	5	111	2	1	1	120	16	0	316	
4:45 PM	57	15	0	0	14	6	10	0	7	85	1	0	2	90	8	1	296	
4:50 PM	59	4	1	0	19	8	12	0	2	90	1	2	3	128	4	0	333	
4:55 PM	46	13	1	0	10	9	5	0	3	83	1	2	2	93	7	0	275	3709
5:00 PM	51	7	1	0	8	4	5	0	6	106	1	0	1	115	4	0	309	3699
5:05 PM	64	10	1	0	14	2	11	0	2	114	1	0	1	150	7	0	377	3755
5:10 PM	44	13	1	0	9	7	9	0	2	87	0	1	2	112	8	1	296	3722
5:15 PM	47	5	2	0	21	5	6	0	5	118	0	0	0	124	8	0	341	3747
5:20 PM	59	5	4	0	13	7	15	0	3	109	1	0	2	137	7	0	362	3843
5:25 PM	59	9	3	0	14	7	11	0	8	86	0	0	3	104	7	0	311	3790
5:30 PM	41	9	1	0	8	3	11	0	3	88	1	1	3	115	4	0	288	3803
5:35 PM	31	13	0	0	12	7	9	0	5	111	0	2	0	122	3	0	315	3819
5:40 PM	80	2	1	0	11	3	9	0	4	91	0	0	2	132	10	0	345	3848
5:45 PM	45	7	1	0	10	6	5	0	5	95	1	1	0	99	4	0	279	3831
5:50 PM	48	8	0	0	10	9	3	0	6	98	0	0	1	120	9	0	312	3810
5:55 PM	61	14	1	0	7	0	4	0	9	107	0	0	2	116	11	0	332	3867
Peak 15-Min Flowrates	Northbound				Southbound				Eastbound				Westbound				Total	
	Left	Thru	Right	U	Left	Thru	Right	U	Left	Thru	Right	U	Left	Thru	Right	U		
All Vehicles	620	112	16	0	176	56	104	0	36	1276	4	4	12	1544	92	4	4056	
Heavy Trucks	40	0	0		0	0	0		0	28	0		0	56	0		124	
Pedestrians		16				0				32				4			52	
Bicycles	1	0	1		0	0	0		0	0	0		0	1	0		3	
Railroad																		
Stopped Buses																		

Comments:

Appendix B
Description of Level-of-Service
Methods and Criteria

APPENDIX B LEVEL-OF-SERVICE CONCEPT

Level of service (LOS) is a concept developed to quantify the degree of comfort (including such elements as travel time, number of stops, total amount of stopped delay, and impediments caused by other vehicles) afforded to drivers as they travel through an intersection or roadway segment. Six grades are used to denote the various level of service from “A” to “F”.¹

SIGNALIZED INTERSECTIONS

The six level-of-service grades are described qualitatively for signalized intersections in Table B1. Additionally, Table B2 identifies the relationship between level of service and average control delay per vehicle. Control delay is defined to include initial deceleration delay, queue move-up time, stopped delay, and final acceleration delay. Using this definition, Level of Service “D” is generally considered to represent the minimum acceptable design standard.

Table B-1 Level-of-Service Definitions (Signalized Intersections)

Level of Service	Average Delay per Vehicle
A	Very low average control delay, less than 10 seconds per vehicle. This occurs when progression is extremely favorable, and most vehicles arrive during the green phase. Most vehicles do not stop at all. Short cycle lengths may also contribute to low delay.
B	Average control delay is greater than 10 seconds per vehicle and less than or equal to 20 seconds per vehicle. This generally occurs with good progression and/or short cycle lengths. More vehicles stop than for a level of service A, causing higher levels of average delay.
C	Average control delay is greater than 20 seconds per vehicle and less than or equal to 35 seconds per vehicle. These higher delays may result from fair progression and/or longer cycle lengths. Individual cycle failures may begin to appear at this level. The number of vehicles stopping is significant at this level, although many still pass through the intersection without stopping.
D	Average control delay is greater than 35 seconds per vehicle and less than or equal to 55 seconds per vehicle. The influence of congestion becomes more noticeable. Longer delays may result from some combination of unfavorable progression, long cycle length, or high volume/capacity ratios. Many vehicles stop, and the proportion of vehicles not stopping declines. Individual cycle failures are noticeable.
E	Average control delay is greater than 55 seconds per vehicle and less than or equal to 80 seconds per vehicle. This is usually considered to be the limit of acceptable delay. These high delay values generally (but not always) indicate poor progression, long cycle lengths, and high volume/capacity ratios. Individual cycle failures are frequent occurrences.
F	Average control delay is in excess of 80 seconds per vehicle. This is considered to be unacceptable to most drivers. This condition often occurs with oversaturation. It may also occur at high volume/capacity ratios below 1.0 with many individual cycle failures. Poor progression and long cycle lengths may also contribute to such high delay values.

¹ Most of the material in this appendix is adapted from the Transportation Research Board, Highway Capacity Manual, (2000).

Table B2 Level-of-Service Criteria for Signalized Intersections

Level of Service	Average Control Delay per Vehicle (Seconds)
A	<10.0
B	>10 and ≤20
C	>20 and ≤35
D	>35 and ≤55
E	>55 and ≤80
F	>80

UNSIGNALIZED INTERSECTIONS

Unsignalized intersections include two-way stop-controlled (TWSC) and all-way stop-controlled (AWSC) intersections. The 2000 Highway Capacity Manual (HCM) provides models for estimating control delay at both TWSC and AWSC intersections. A qualitative description of the various service levels associated with an unsignalized intersection is presented in Table B3. A quantitative definition of level of service for unsignalized intersections is presented in Table B4. Using this definition, Level of Service “E” is generally considered to represent the minimum acceptable design standard.

Table B3 Level-of-Service Criteria for Unsignalized Intersections

Level of Service	Average Delay per Vehicle to Minor Street
A	<ul style="list-style-type: none"> Nearly all drivers find freedom of operation. Very seldom is there more than one vehicle in queue.
B	<ul style="list-style-type: none"> Some drivers begin to consider the delay an inconvenience. Occasionally there is more than one vehicle in queue.
C	<ul style="list-style-type: none"> Many times there is more than one vehicle in queue. Most drivers feel restricted, but not objectionably so.
D	<ul style="list-style-type: none"> Often there is more than one vehicle in queue. Drivers feel quite restricted.
E	<ul style="list-style-type: none"> Represents a condition in which the demand is near or equal to the probable maximum number of vehicles that can be accommodated by the movement. There is almost always more than one vehicle in queue. Drivers find the delays approaching intolerable levels.
F	<ul style="list-style-type: none"> Forced flow. Represents an intersection failure condition that is caused by geometric and/or operational constraints external to the intersection.

Table B4 Level-of-Service Criteria for Unsignalized Intersections

Level of Service	Average Control Delay per Vehicle (Seconds)
A	<10.0
B	>10.0 and ≤ 15.0
C	>15.0 and ≤ 25.0
D	>25.0 and ≤ 35.0
E	>35.0 and ≤ 50.0
F	>50.0

It should be noted that the level-of-service criteria for unsignalized intersections are somewhat different than the criteria used for signalized intersections. The primary reason for this difference is that drivers expect different levels of performance from different kinds of transportation facilities. The expectation is that a signalized intersection is designed to carry higher traffic volumes than an unsignalized intersection. Additionally, there are a number of driver behavior considerations that combine to make delays at signalized intersections less galling than at unsignalized intersections. For example, drivers at signalized intersections are able to relax during the red interval, while drivers on the minor street approaches to TWSC intersections must remain attentive to the task of identifying acceptable gaps and vehicle conflicts. Also, there is often much more variability in the amount of delay experienced by individual drivers at unsignalized intersections than signalized intersections. For these reasons, it is considered that the control delay threshold for any given level of service is less for an unsignalized intersection than for a signalized intersection. While overall intersection level of service is calculated for AWSC intersections, level of service is only calculated for the minor approaches and the major street left turn movements at TWSC intersections. No delay is assumed to the major street through movements. For TWSC intersections, the overall intersection level of service remains undefined: level of service is only calculated for each minor street lane.

In the performance evaluation of TWSC intersections, it is important to consider other measures of effectiveness (MOEs) in addition to delay, such as v/c ratios for individual movements, average queue lengths, and 95th-percentile queue lengths. By focusing on a single MOE for the worst movement only, such as delay for the minor-street left turn, users may make inappropriate traffic control decisions. The potential for making such inappropriate decisions is likely to be particularly pronounced when the HCM level-of-service thresholds are adopted as legal standards, as is the case in many public agencies.

Appendix C Existing Conditions Level-of-
Service Worksheets

Existing AM Peak Hour
 1: Aldersgate Ln & E Crestview Dr

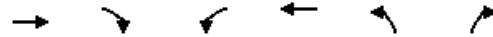

Movement	EBT	EBR	WBL	WBT	NBL	NBR
Lane Configurations	↶			↷	↶	↷
Volume (veh/h)	147	2	2	81	3	4
Sign Control	Free			Free	Stop	
Grade	0%			0%	0%	
Peak Hour Factor	0.63	0.63	0.63	0.63	0.63	0.63
Hourly flow rate (vph)	233	3	3	129	5	6
Pedestrians	4				3	
Lane Width (ft)	12.0				12.0	
Walking Speed (ft/s)	4.0				4.0	
Percent Blockage	0				0	
Right turn flare (veh)						
Median type	None			None		
Median storage (veh)						
Upstream signal (ft)						
pX, platoon unblocked						
vC, conflicting volume			240		377	238
vC1, stage 1 conf vol						
vC2, stage 2 conf vol						
vCu, unblocked vol			240		377	238
tC, single (s)			4.1		6.4	6.2
tC, 2 stage (s)						
tF (s)			2.2		3.5	3.3
p0 queue free %			100		99	99
cM capacity (veh/h)			1336		624	804
Direction, Lane #	EB 1	WB 1	NB 1			
Volume Total	237	132	11			
Volume Left	0	3	5			
Volume Right	3	0	6			
cSH	1700	1336	715			
Volume to Capacity	0.14	0.00	0.02			
Queue Length 95th (ft)	0	0	1			
Control Delay (s)	0.0	0.2	10.1			
Lane LOS		A	B			
Approach Delay (s)	0.0	0.2	10.1			
Approach LOS			B			
Intersection Summary						
Average Delay			0.4			
Intersection Capacity Utilization			18.4%	ICU Level of Service		A
Analysis Period (min)			15			

Existing AM Peak Hour
 2: Aldersgate Ln & Park Ln



Movement	WBL	WBR	NBT	NBR	SBL	SBT
Lane Configurations	Y		T			T
Volume (veh/h)	8	0	4	31	4	2
Sign Control	Stop		Free			Free
Grade	0%		0%			0%
Peak Hour Factor	0.77	0.77	0.77	0.77	0.77	0.77
Hourly flow rate (vph)	10	0	5	40	5	3
Pedestrians	1					
Lane Width (ft)	12.0					
Walking Speed (ft/s)	4.0					
Percent Blockage	0					
Right turn flare (veh)						
Median type			None			None
Median storage (veh)						
Upstream signal (ft)						
pX, platoon unblocked						
vC, conflicting volume	39	26			46	
vC1, stage 1 conf vol						
vC2, stage 2 conf vol						
vCu, unblocked vol	39	26			46	
tC, single (s)	6.4	6.2			4.1	
tC, 2 stage (s)						
tF (s)	3.5	3.3			2.2	
p0 queue free %	99	100			100	
cM capacity (veh/h)	974	1054			1573	

Direction, Lane #	WB 1	NB 1	SB 1
Volume Total	10	45	8
Volume Left	10	0	5
Volume Right	0	40	0
cSH	974	1700	1573
Volume to Capacity	0.01	0.03	0.00
Queue Length 95th (ft)	1	0	0
Control Delay (s)	8.7	0.0	4.9
Lane LOS	A		A
Approach Delay (s)	8.7	0.0	4.9
Approach LOS	A		

















Intersection Summary			
Average Delay		2.0	
Intersection Capacity Utilization		13.7%	ICU Level of Service A
Analysis Period (min)		15	

Existing AM Peak Hour
 4: Villa Rd & Park Ln

























Movement	EBL	EBR	NBL	NBT	SBT	SBR
Lane Configurations						
Volume (veh/h)	1	38	9	138	253	0
Sign Control	Stop			Free	Free	
Grade	0%			0%	0%	
Peak Hour Factor	0.69	0.69	0.69	0.69	0.69	0.69
Hourly flow rate (vph)	1	55	13	200	367	0
Pedestrians				1	2	
Lane Width (ft)				12.0	12.0	
Walking Speed (ft/s)				4.0	4.0	
Percent Blockage				0	0	
Right turn flare (veh)						
Median type				None	None	
Median storage (veh)						
Upstream signal (ft)						
pX, platoon unblocked						
vC, conflicting volume	595	368	367			
vC1, stage 1 conf vol						
vC2, stage 2 conf vol						
vCu, unblocked vol	595	368	367			
tC, single (s)	6.4	6.2	4.1			
tC, 2 stage (s)						
tF (s)	3.5	3.3	2.2			
p0 queue free %	100	92	99			
cM capacity (veh/h)	465	682	1203			
Direction, Lane #	EB 1	NB 1	SB 1			
Volume Total	57	213	367			
Volume Left	1	13	0			
Volume Right	55	0	0			
cSH	674	1203	1700			
Volume to Capacity	0.08	0.01	0.22			
Queue Length 95th (ft)	7	1	0			
Control Delay (s)	10.8	0.6	0.0			
Lane LOS	B	A				
Approach Delay (s)	10.8	0.6	0.0			
Approach LOS	B					
Intersection Summary						
Average Delay			1.2			
Intersection Capacity Utilization		25.0%		ICU Level of Service		A
Analysis Period (min)			15			

Existing AM Peak Hour
 6: Villa Rd & Fulton St

												
Movement	EBL	EBT	EBR	WBL	WBT	WBR	NBL	NBT	NBR	SBL	SBT	SBR
Lane Configurations												
Volume (veh/h)	121	1	57	2	1	1	66	90	4	4	169	70
Sign Control		Stop			Stop			Free			Free	
Grade		0%			0%			0%			0%	
Peak Hour Factor	0.84	0.84	0.84	0.84	0.84	0.84	0.84	0.84	0.84	0.84	0.84	0.84
Hourly flow rate (vph)	144	1	68	2	1	1	79	107	5	5	201	83
Pedestrians		15			3			2			3	
Lane Width (ft)		12.0			12.0			12.0			12.0	
Walking Speed (ft/s)		4.0			4.0			4.0			4.0	
Percent Blockage		1			0			0			0	
Right turn flare (veh)			6									
Median type								None			None	
Median storage (veh)												
Upstream signal (ft)												
pX, platoon unblocked												
vC, conflicting volume	539	539	260	559	579	116	300			115		
vC1, stage 1 conf vol												
vC2, stage 2 conf vol												
vCu, unblocked vol	539	539	260	559	579	116	300			115		
tC, single (s)	7.1	6.5	6.2	7.1	6.5	6.2	4.1			4.1		
tC, 2 stage (s)												
tF (s)	3.5	4.0	3.3	3.5	4.0	3.3	2.2			2.2		
p0 queue free %	66	100	91	99	100	100	94			100		
cM capacity (veh/h)	419	416	768	377	395	938	1257			1483		
Direction, Lane #	EB 1	WB 1	NB 1	SB 1								
Volume Total	213	5	190	289								
Volume Left	144	2	79	5								
Volume Right	68	1	5	83								
cSH	615	449	1257	1483								
Volume to Capacity	0.35	0.01	0.06	0.00								
Queue Length 95th (ft)	39	1	5	0								
Control Delay (s)	15.5	13.1	3.6	0.2								
Lane LOS	C	B	A	A								
Approach Delay (s)	15.5	13.1	3.6	0.2								
Approach LOS	C	B										
Intersection Summary												
Average Delay			5.9									
Intersection Capacity Utilization			44.9%		ICU Level of Service					A		
Analysis Period (min)			15									

Existing AM Peak Hour
 7: Villa Rd & Hwy 99W

												
Movement	EBL	EBT	EBR	WBL	WBT	WBR	NBL	NBT	NBR	SBL	SBT	SBR
Lane Configurations		 			 							
Volume (vph)	88	1219	2	7	844	93	345	62	9	116	59	48
Ideal Flow (vphpl)	1900	1900	1900	1900	1900	1900	1900	1900	1900	1900	1900	1900
Total Lost time (s)	4.5	4.5		4.5	4.5		4.5	5.0		4.5	5.0	5.0
Lane Util. Factor	1.00	0.95		1.00	0.91		0.97	1.00		1.00	1.00	1.00
Frbp, ped/bikes	1.00	1.00		1.00	1.00		1.00	1.00		1.00	1.00	1.00
Flpb, ped/bikes	1.00	1.00		1.00	1.00		1.00	1.00		1.00	1.00	1.00
Frt	1.00	1.00		1.00	0.99		1.00	0.98		1.00	1.00	0.85
Flt Protected	0.95	1.00		0.95	1.00		0.95	1.00		0.95	1.00	1.00
Satd. Flow (prot)	1805	3437		1805	4635		2968	1668		1752	1900	1583
Flt Permitted	0.95	1.00		0.95	1.00		0.95	1.00		0.95	1.00	1.00
Satd. Flow (perm)	1805	3437		1805	4635		2968	1668		1752	1900	1583
Peak-hour factor, PHF	0.90	0.90	0.90	0.90	0.90	0.90	0.90	0.90	0.90	0.90	0.90	0.90
Adj. Flow (vph)	98	1354	2	8	938	103	383	69	10	129	66	53
RTOR Reduction (vph)	0	0	0	0	7	0	0	8	0	0	0	49
Lane Group Flow (vph)	98	1356	0	8	1034	0	383	71	0	129	66	4
Confl. Peds. (#/hr)	1		2	2		1			2	2		
Heavy Vehicles (%)	0%	5%	0%	0%	11%	1%	18%	10%	22%	3%	0%	2%
Turn Type	Prot	NA		Prot	NA		Prot	NA		Prot	NA	Perm
Protected Phases	7	4		3	8		5	2		1	6	
Permitted Phases												6
Actuated Green, G (s)	9.1	59.5		1.3	51.7		13.1	11.5		9.2	7.6	7.6
Effective Green, g (s)	9.1	59.5		1.3	51.7		13.1	11.5		9.2	7.6	7.6
Actuated g/C Ratio	0.09	0.60		0.01	0.52		0.13	0.12		0.09	0.08	0.08
Clearance Time (s)	4.5	4.5		4.5	4.5		4.5	5.0		4.5	5.0	5.0
Vehicle Extension (s)	2.5	2.5		2.5	2.5		2.5	4.2		2.5	4.2	4.2
Lane Grp Cap (vph)	164	2045		23	2396		388	191		161	144	120
v/s Ratio Prot	c0.05	c0.39		0.00	0.22		c0.13	c0.04		0.07	0.03	
v/s Ratio Perm												0.00
v/c Ratio	0.60	0.66		0.35	0.43		0.99	0.37		0.80	0.46	0.03
Uniform Delay, d1	43.7	13.5		48.9	15.0		43.4	40.9		44.5	44.2	42.8
Progression Factor	1.00	1.00		1.00	1.00		1.00	1.00		1.00	1.00	1.00
Incremental Delay, d2	4.8	0.7		6.5	0.1		41.9	5.5		23.5	10.2	0.5
Delay (s)	48.5	14.3		55.5	15.1		85.2	46.4		68.1	54.4	43.3
Level of Service	D	B		E	B		F	D		E	D	D
Approach Delay (s)		16.6			15.4			78.6			59.1	
Approach LOS		B			B			E			E	
Intersection Summary												
HCM 2000 Control Delay			28.4				HCM 2000 Level of Service				C	
HCM 2000 Volume to Capacity ratio			0.70									
Actuated Cycle Length (s)			100.0				Sum of lost time (s)			18.5		
Intersection Capacity Utilization			74.6%				ICU Level of Service			D		
Analysis Period (min)			15									
c Critical Lane Group												

Existing AM Peak Hour
7: Villa Rd & Hwy 99W





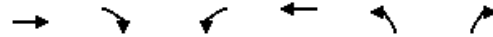



Movement	EBL	EBT	EBR	WBL	WBT	WBR	NBL	NBT	NBR	SBL	SBT	SBR
Lane Configurations												
Volume (veh/h)	88	1219	2	7	844	93	345	62	9	116	59	48
Number	7	4	14	3	8	18	5	2	12	1	6	16
Initial Q (Qb), veh	0	0	0	0	0	0	0	0	0	0	0	0
Ped-Bike Adj(A_pbT)	1.00		1.00	1.00		1.00	1.00		1.00	1.00		1.00
Parking Bus, Adj	1.00	1.00	1.00	1.00	1.00	1.00	1.00	1.00	1.00	1.00	1.00	1.00
Adj Sat Flow, veh/h/ln	1900	1810	1900	1900	1727	1900	1610	1704	1900	1845	1900	1863
Adj Flow Rate, veh/h	98	1354	2	8	938	103	383	69	10	129	66	53
Adj No. of Lanes	1	2	0	1	3	0	2	1	0	1	1	1
Peak Hour Factor	0.90	0.90	0.90	0.90	0.90	0.90	0.90	0.90	0.90	0.90	0.90	0.90
Percent Heavy Veh, %	0	5	5	0	11	11	18	10	10	3	0	2
Cap, veh/h	123	1068	2	21	1064	116	260	682	99	110	843	701
Arrive On Green	0.07	0.30	0.30	0.01	0.25	0.25	0.09	0.47	0.47	0.06	0.44	0.44
Sat Flow, veh/h	1810	3523	5	1810	4313	472	2975	1455	211	1757	1900	1581
Grp Volume(v), veh/h	98	661	695	8	683	358	383	0	79	129	66	53
Grp Sat Flow(s),veh/h/ln	1810	1719	1809	1810	1572	1642	1487	0	1666	1757	1900	1581
Q Serve(g_s), s	6.4	36.4	36.4	0.5	25.1	25.2	10.5	0.0	3.2	7.5	2.4	2.3
Cycle Q Clear(g_c), s	6.4	36.4	36.4	0.5	25.1	25.2	10.5	0.0	3.2	7.5	2.4	2.3
Prop In Lane	1.00		0.00	1.00		0.29	1.00		0.13	1.00		1.00
Lane Grp Cap(c), veh/h	123	521	548	21	775	405	260	0	781	110	843	701
V/C Ratio(X)	0.79	1.27	1.27	0.38	0.88	0.88	1.47	0.00	0.10	1.17	0.08	0.08
Avail Cap(c_a), veh/h	279	521	548	279	891	465	260	0	781	110	843	701
HCM Platoon Ratio	1.00	1.00	1.00	1.00	1.00	1.00	1.00	1.00	1.00	1.00	1.00	1.00
Upstream Filter(I)	1.00	1.00	1.00	1.00	1.00	1.00	1.00	0.00	1.00	1.00	1.00	1.00
Uniform Delay (d), s/veh	55.1	41.8	41.8	58.9	43.5	43.5	54.8	0.0	17.8	56.3	19.3	19.2
Incr Delay (d2), s/veh	8.3	135.1	134.5	8.0	8.9	15.9	231.8	0.0	0.3	140.4	0.2	0.2
Initial Q Delay(d3),s/veh	0.0	0.0	0.0	0.0	0.0	0.0	0.0	0.0	0.0	0.0	0.0	0.0
%ile BackOfQ(50%),veh/ln	3.5	36.8	38.6	0.3	11.9	13.2	12.7	0.0	1.5	7.9	1.3	1.1
LnGrp Delay(d),s/veh	63.4	176.9	176.3	66.9	52.4	59.5	286.6	0.0	18.1	196.7	19.4	19.4
LnGrp LOS	E	F	F	E	D	E	F		B	F	B	B
Approach Vol, veh/h		1454			1049			462			248	
Approach Delay, s/veh		168.9			54.9			240.7			111.6	
Approach LOS		F			D			F			F	
Timer	1	2	3	4	5	6	7	8				
Assigned Phs	1	2	3	4	5	6	7	8				
Phs Duration (G+Y+Rc), s	12.0	61.2	5.9	40.9	15.0	58.2	12.7	34.1				
Change Period (Y+Rc), s	4.5	5.0	4.5	4.5	4.5	5.0	4.5	4.5				
Max Green Setting (Gmax), s	7.5	42.0	18.5	31.0	10.5	39.0	18.5	34.0				
Max Q Clear Time (g_c+I1), s	9.5	5.2	2.5	38.4	12.5	4.4	8.4	27.2				
Green Ext Time (p_c), s	0.0	1.6	0.0	0.0	0.0	1.6	0.1	2.3				
Intersection Summary												
HCM 2010 Ctrl Delay			137.6									
HCM 2010 LOS			F									

Existing PM Peak Hour
 1: Aldersgate Ln & E Crestview Dr



Movement	EBT	EBR	WBL	WBT	NBL	NBR
Lane Configurations	↶			↷	↷	
Volume (veh/h)	56	4	3	112	2	2
Sign Control	Free			Free	Stop	
Grade	0%			0%	0%	
Peak Hour Factor	0.83	0.83	0.83	0.83	0.83	0.83
Hourly flow rate (vph)	67	5	4	135	2	2
Pedestrians	4			1	4	
Lane Width (ft)	12.0			12.0	12.0	
Walking Speed (ft/s)	4.0			4.0	4.0	
Percent Blockage	0			0	0	
Right turn flare (veh)						
Median type	None			None		
Median storage (veh)						
Upstream signal (ft)						
pX, platoon unblocked						
vC, conflicting volume			76		220	75
vC1, stage 1 conf vol						
vC2, stage 2 conf vol						
vCu, unblocked vol			76		220	75
tC, single (s)			4.1		6.4	6.2
tC, 2 stage (s)						
tF (s)			2.2		3.5	3.3
p0 queue free %			100		100	100
cM capacity (veh/h)			1530		766	988
Direction, Lane #	EB 1	WB 1	NB 1			
Volume Total	72	139	5			
Volume Left	0	4	2			
Volume Right	5	0	2			
cSH	1700	1530	863			
Volume to Capacity	0.04	0.00	0.01			
Queue Length 95th (ft)	0	0	0			
Control Delay (s)	0.0	0.2	9.2			
Lane LOS		A	A			
Approach Delay (s)	0.0	0.2	9.2			
Approach LOS			A			
Intersection Summary						
Average Delay			0.3			
Intersection Capacity Utilization			18.6%	ICU Level of Service		A
Analysis Period (min)			15			

Existing PM Peak Hour
 2: Aldersgate Ln & Park Ln

						
Movement	WBL	WBR	NBT	NBR	SBL	SBT
Lane Configurations						
Volume (veh/h)	50	7	2	18	7	1
Sign Control	Stop		Free			Free
Grade	0%		0%			0%
Peak Hour Factor	0.71	0.71	0.71	0.71	0.71	0.71
Hourly flow rate (vph)	70	10	3	25	10	1
Pedestrians	1		1			
Lane Width (ft)	12.0		12.0			
Walking Speed (ft/s)	4.0		4.0			
Percent Blockage	0		0			
Right turn flare (veh)						
Median type			None			None
Median storage (veh)						
Upstream signal (ft)						
pX, platoon unblocked						
vC, conflicting volume	39	16			29	
vC1, stage 1 conf vol						
vC2, stage 2 conf vol						
vCu, unblocked vol	39	16			29	
tC, single (s)	6.4	6.3			4.1	
tC, 2 stage (s)						
tF (s)	3.5	3.4			2.2	
p0 queue free %	93	99			99	
cM capacity (veh/h)	966	1028			1596	
Direction, Lane #	WB 1	NB 1	SB 1			
Volume Total	80	28	11			
Volume Left	70	0	10			
Volume Right	10	25	0			
cSH	973	1700	1596			
Volume to Capacity	0.08	0.02	0.01			
Queue Length 95th (ft)	7	0	0			
Control Delay (s)	9.0	0.0	6.4			
Lane LOS	A		A			
Approach Delay (s)	9.0	0.0	6.4			
Approach LOS	A					
Intersection Summary						
Average Delay			6.7			
Intersection Capacity Utilization			16.0%	ICU Level of Service		A
Analysis Period (min)			15			

Existing PM Peak Hour
 4: Villa Rd & Park Ln

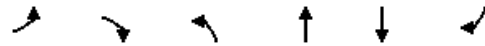

Movement	EBL	EBR	NBL	NBT	SBT	SBR
Lane Configurations						
Volume (veh/h)	1	26	52	216	153	5
Sign Control	Stop			Free	Free	
Grade	0%			0%	0%	
Peak Hour Factor	0.85	0.85	0.85	0.85	0.85	0.85
Hourly flow rate (vph)	1	31	61	254	180	6
Pedestrians					1	
Lane Width (ft)					12.0	
Walking Speed (ft/s)					4.0	
Percent Blockage					0	
Right turn flare (veh)						
Median type				None	None	
Median storage (veh)						
Upstream signal (ft)						
pX, platoon unblocked						
vC, conflicting volume	560	183	186			
vC1, stage 1 conf vol						
vC2, stage 2 conf vol						
vCu, unblocked vol	560	183	186			
tC, single (s)	6.4	6.2	4.1			
tC, 2 stage (s)						
tF (s)	3.5	3.3	2.2			
p0 queue free %	100	96	96			
cM capacity (veh/h)	471	865	1401			
Direction, Lane #	EB 1	NB 1	SB 1			
Volume Total	32	315	186			
Volume Left	1	61	0			
Volume Right	31	0	6			
cSH	839	1401	1700			
Volume to Capacity	0.04	0.04	0.11			
Queue Length 95th (ft)	3	3	0			
Control Delay (s)	9.5	1.8	0.0			
Lane LOS	A	A				
Approach Delay (s)	9.5	1.8	0.0			
Approach LOS	A					
Intersection Summary						
Average Delay			1.6			
Intersection Capacity Utilization			35.9%	ICU Level of Service		A
Analysis Period (min)			15			

Existing PM Peak Hour
6: Villa Rd & Fulton St

Movement	EBL	EBT	EBR	WBL	WBT	WBR	NBL	NBT	NBR	SBL	SBT	SBR	
Lane Configurations													
Volume (veh/h)	115	0	72	3	0	1	82	172	6	0	139	151	
Sign Control		Stop			Stop			Free			Free		
Grade		0%			0%			0%			0%		
Peak Hour Factor	0.87	0.87	0.87	0.87	0.87	0.87	0.87	0.87	0.87	0.87	0.87	0.87	
Hourly flow rate (vph)	132	0	83	3	0	1	94	198	7	0	160	174	
Pedestrians		13			1			1			8		
Lane Width (ft)		12.0			12.0			12.0			12.0		
Walking Speed (ft/s)		4.0			4.0			4.0			4.0		
Percent Blockage		1			0			0			1		
Right turn flare (veh)			6										
Median type								None			None		
Median storage (veh)													
Upstream signal (ft)													
pX, platoon unblocked													
vC, conflicting volume	658	654	261	680	737	210	346			206			
vC1, stage 1 conf vol													
vC2, stage 2 conf vol													
vCu, unblocked vol	658	654	261	680	737	210	346			206			
tC, single (s)	7.1	6.5	6.2	7.1	6.5	6.2	4.1			4.1			
tC, 2 stage (s)													
tF (s)	3.5	4.0	3.3	3.5	4.0	3.3	2.2			2.2			
p0 queue free %	62	100	89	99	100	100	92			100			
cM capacity (veh/h)	346	354	771	305	317	829	1199			1377			
Direction, Lane #	EB 1	WB 1	NB 1	SB 1									
Volume Total	215	5	299	333									
Volume Left	132	3	94	0									
Volume Right	83	1	7	174									
cSH	563	363	1199	1377									
Volume to Capacity	0.38	0.01	0.08	0.00									
Queue Length 95th (ft)	44	1	6	0									
Control Delay (s)	17.3	15.1	3.1	0.0									
Lane LOS	C	C	A										
Approach Delay (s)	17.3	15.1	3.1	0.0									
Approach LOS	C	C											
Intersection Summary													
Average Delay			5.5										
Intersection Capacity Utilization			49.2%		ICU Level of Service					A			
Analysis Period (min)			15										

Existing PM Peak Hour
 7: Villa Rd & Hwy 99W

Movement	EBL	EBT	EBR	WBL	WBT	WBR	NBL	NBT	NBR	SBL	SBT	SBR
Lane Configurations												
Volume (vph)	63	1210	5	18	1446	82	630	102	16	137	60	98
Ideal Flow (vphpl)	1900	1900	1900	1900	1900	1900	1900	1900	1900	1900	1900	1900
Total Lost time (s)	4.5	4.5		4.5	4.5		4.5	5.0		4.5	5.0	5.0
Lane Util. Factor	1.00	0.95		1.00	0.91		0.97	1.00		1.00	1.00	1.00
Frbp, ped/bikes	1.00	1.00		1.00	1.00		1.00	1.00		1.00	1.00	0.96
Flpb, ped/bikes	1.00	1.00		1.00	1.00		1.00	1.00		1.00	1.00	1.00
Frt	1.00	1.00		1.00	0.99		1.00	0.98		1.00	1.00	0.85
Flt Protected	0.95	1.00		0.95	1.00		0.95	1.00		0.95	1.00	1.00
Satd. Flow (prot)	1805	3469		1805	4995		3335	1809		1805	1900	1517
Flt Permitted	0.95	1.00		0.95	1.00		0.95	1.00		0.95	1.00	1.00
Satd. Flow (perm)	1805	3469		1805	4995		3335	1809		1805	1900	1517
Peak-hour factor, PHF	0.95	0.95	0.95	0.95	0.95	0.95	0.95	0.95	0.95	0.95	0.95	0.95
Adj. Flow (vph)	66	1274	5	19	1522	86	663	107	17	144	63	103
RTOR Reduction (vph)	0	0	0	0	3	0	0	8	0	0	0	93
Lane Group Flow (vph)	66	1279	0	19	1605	0	663	116	0	144	63	10
Confl. Peds. (#/hr)	1		15	15		1	25		6	6		25
Confl. Bikes (#/hr)						2			1			1
Heavy Vehicles (%)	0%	4%	0%	0%	3%	1%	5%	2%	6%	0%	0%	2%
Turn Type	Prot	NA		Prot	NA		Prot	NA		Prot	NA	Perm
Protected Phases	7	4		3	8		5	2		1	6	
Permitted Phases												6
Actuated Green, G (s)	8.2	70.5		3.0	65.3		16.2	12.6		15.4	11.8	11.8
Effective Green, g (s)	8.2	70.5		3.0	65.3		16.2	12.6		15.4	11.8	11.8
Actuated g/C Ratio	0.07	0.59		0.02	0.54		0.13	0.10		0.13	0.10	0.10
Clearance Time (s)	4.5	4.5		4.5	4.5		4.5	5.0		4.5	5.0	5.0
Vehicle Extension (s)	2.5	2.5		2.5	2.5		2.5	4.2		2.5	4.2	4.2
Lane Grp Cap (vph)	123	2038		45	2718		450	189		231	186	149
v/s Ratio Prot	c0.04	c0.37		0.01	0.32		c0.20	c0.06		0.08	0.03	
v/s Ratio Perm												0.01
v/c Ratio	0.54	0.63		0.42	0.59		1.47	0.61		0.62	0.34	0.07
Uniform Delay, d1	54.1	16.2		57.6	18.4		51.9	51.4		49.6	50.5	49.1
Progression Factor	1.00	1.00		1.00	1.00		1.00	1.00		1.00	1.00	1.00
Incremental Delay, d2	3.5	0.5		4.6	0.3		224.8	14.0		4.5	4.9	0.9
Delay (s)	57.5	16.7		62.2	18.7		276.7	65.4		54.0	55.3	50.0
Level of Service	E	B		E	B		F	E		D	E	D
Approach Delay (s)		18.7			19.2			243.4			53.0	
Approach LOS		B			B			F			D	

Intersection Summary		
HCM 2000 Control Delay	65.0	HCM 2000 Level of Service E
HCM 2000 Volume to Capacity ratio	0.77	
Actuated Cycle Length (s)	120.0	Sum of lost time (s) 18.5
Intersection Capacity Utilization	86.1%	ICU Level of Service E
Analysis Period (min)	15	

c Critical Lane Group

Existing PM Peak Hour
7: Villa Rd & Hwy 99W

Movement	EBL	EBT	EBR	WBL	WBT	WBR	NBL	NBT	NBR	SBL	SBT	SBR
Lane Configurations												
Volume (veh/h)	63	1210	5	18	1446	82	630	102	16	137	60	98
Number	7	4	14	3	8	18	5	2	12	1	6	16
Initial Q (Qb), veh	0	0	0	0	0	0	0	0	0	0	0	0
Ped-Bike Adj(A_pbT)	1.00		0.97	1.00		0.95	1.00		0.97	1.00		0.97
Parking Bus, Adj	1.00	1.00	1.00	1.00	1.00	1.00	1.00	1.00	1.00	1.00	1.00	1.00
Adj Sat Flow, veh/h/ln	1900	1827	1900	1900	1847	1900	1810	1853	1900	1900	1900	1863
Adj Flow Rate, veh/h	66	1274	5	19	1522	86	663	107	17	144	63	103
Adj No. of Lanes	1	2	0	1	3	0	2	1	0	1	1	1
Peak Hour Factor	0.95	0.95	0.95	0.95	0.95	0.95	0.95	0.95	0.95	0.95	0.95	0.95
Percent Heavy Veh, %	0	4	4	0	3	3	5	2	2	0	0	2
Cap, veh/h	85	937	4	40	1165	66	247	792	126	134	968	785
Arrive On Green	0.05	0.26	0.26	0.02	0.24	0.24	0.07	0.51	0.51	0.07	0.51	0.51
Sat Flow, veh/h	1810	3546	14	1810	4866	275	3343	1554	247	1810	1900	1541
Grp Volume(v), veh/h	66	624	655	19	1051	557	663	0	124	144	63	103
Grp Sat Flow(s),veh/h/ln	1810	1736	1824	1810	1680	1780	1672	0	1801	1810	1900	1541
Q Serve(g_s), s	5.1	37.5	37.5	1.5	34.0	34.0	10.5	0.0	5.2	10.5	2.4	5.0
Cycle Q Clear(g_c), s	5.1	37.5	37.5	1.5	34.0	34.0	10.5	0.0	5.2	10.5	2.4	5.0
Prop In Lane	1.00		0.01	1.00		0.15	1.00		0.14	1.00		1.00
Lane Grp Cap(c), veh/h	85	458	482	40	805	426	247	0	917	134	968	785
V/C Ratio(X)	0.78	1.36	1.36	0.47	1.31	1.31	2.68	0.00	0.14	1.08	0.07	0.13
Avail Cap(c_a), veh/h	299	458	482	299	805	426	247	0	917	134	968	785
HCM Platoon Ratio	1.00	1.00	1.00	1.00	1.00	1.00	1.00	1.00	1.00	1.00	1.00	1.00
Upstream Filter(I)	1.00	1.00	1.00	1.00	1.00	1.00	1.00	0.00	1.00	1.00	1.00	1.00
Uniform Delay (d), s/veh	66.9	52.2	52.2	68.6	54.0	54.0	65.8	0.0	18.4	65.8	17.7	18.3
Incr Delay (d2), s/veh	10.7	175.7	175.2	6.2	146.8	154.2	768.3	0.0	0.3	99.7	0.1	0.3
Initial Q Delay(d3),s/veh	0.0	0.0	0.0	0.0	0.0	0.0	0.0	0.0	0.0	0.0	0.0	0.0
%ile BackOfQ(50%),veh/ln	2.8	40.3	42.3	0.8	32.2	34.9	31.2	0.0	2.6	8.9	1.3	2.2
LnGrp Delay(d),s/veh	77.6	228.0	227.5	74.8	200.8	208.2	834.0	0.0	18.7	165.4	17.8	18.7
LnGrp LOS	E	F	F	E	F	F	F		B	F	B	B
Approach Vol, veh/h		1345			1627			787			310	
Approach Delay, s/veh		220.3			201.8			705.6			86.7	
Approach LOS		F			F			F			F	
Timer	1	2	3	4	5	6	7	8				
Assigned Phs	1	2	3	4	5	6	7	8				
Phs Duration (G+Y+Rc), s	15.0	77.3	7.7	42.0	15.0	77.3	11.2	38.5				
Change Period (Y+Rc), s	4.5	5.0	4.5	4.5	4.5	5.0	4.5	4.5				
Max Green Setting (Gmax), s	10.5	55.0	23.5	31.0	10.5	55.0	23.5	34.0				
Max Q Clear Time (g_c+I1), s	12.5	7.2	3.5	39.5	12.5	7.0	7.1	36.0				
Green Ext Time (p_c), s	0.0	2.4	0.0	0.0	0.0	2.4	0.1	0.0				
Intersection Summary												
HCM 2010 Ctrl Delay			296.6									
HCM 2010 LOS			F									

Appendix D Crash Data

OREGON DEPARTMENT OF TRANSPORTATION - TRANSPORTATION DEVELOPMENT DIVISION
TRANSPORTATION DATA SECTION - CRASH ANALYSIS AND REPORTING UNIT
CRASH SUMMARIES BY YEAR BY COLLISION TYPE

Aldersgate Lane & Park Lane
January 1, 2009 through December 31, 2013

COLLISION TYPE	FATAL CRASHES	NON- FATAL CRASHES	PROPERTY DAMAGE ONLY	TOTAL CRASHES	PEOPLE KILLED	PEOPLE INJURED	TRUCKS	DRY SURF	WET SURF	DAY	DARK	INTER- SECTION	INTER- SECTION RELATED	OFF- ROAD
----------------	------------------	--------------------------	----------------------------	------------------	------------------	-------------------	--------	-------------	-------------	-----	------	-------------------	------------------------------	--------------

YEAR:

TOTAL

FINAL TOTAL

Disclaimer: A higher number of crashes may be reported as of 2011 compared to prior years. This does not reflect an increase in annual crashes. The higher numbers result from a change to an internal departmental process that allows the Crash Analysis and Reporting Unit to add previously unavailable, non-fatal crash reports to the annual data file. Please be aware of this change when comparing pre-2011 crash statistics.

OREGON DEPARTMENT OF TRANSPORTATION - TRANSPORTATION DEVELOPMENT DIVISION
TRANSPORTATION DATA SECTION - CRASH ANALYSIS AND REPORTING UNIT
CRASH SUMMARIES BY YEAR BY COLLISION TYPE

Villa Road & Fulton Street
January 1, 2009 through December 31, 2013

COLLISION TYPE	FATAL CRASHES	NON- FATAL CRASHES	PROPERTY DAMAGE ONLY	TOTAL CRASHES	PEOPLE KILLED	PEOPLE INJURED	TRUCKS	DRY SURF	WET SURF	DAY	DARK	INTER- SECTION	INTER- SECTION RELATED	OFF- ROAD
----------------	------------------	--------------------------	----------------------------	------------------	------------------	-------------------	--------	-------------	-------------	-----	------	-------------------	------------------------------	--------------

YEAR:

TOTAL

FINAL TOTAL

Disclaimer: A higher number of crashes may be reported as of 2011 compared to prior years. This does not reflect an increase in annual crashes. The higher numbers result from a change to an internal departmental process that allows the Crash Analysis and Reporting Unit to add previously unavailable, non-fatal crash reports to the annual data file. Please be aware of this change when comparing pre-2011 crash statistics.

OREGON DEPARTMENT OF TRANSPORTATION - TRANSPORTATION DEVELOPMENT DIVISION
 TRANSPORTATION DATA SECTION - CRASH ANALYSIS AND REPORTING UNIT
 CRASH SUMMARIES BY YEAR BY COLLISION TYPE

Villa Road & OR 99W
 January 1, 2009 through December 31, 2013

COLLISION TYPE	FATAL CRASHES	NON- FATAL CRASHES	PROPERTY DAMAGE ONLY	TOTAL CRASHES	PEOPLE KILLED	PEOPLE INJURED	TRUCKS	DRY SURF	WET SURF	DAY	DARK	INTER- SECTION	INTER- SECTION RELATED	OFF- ROAD
YEAR: 2013														
REAR-END	0	4	2	6	0	8	0	3	2	4	2	6	0	0
TURNING MOVEMENTS	0	0	2	2	0	0	1	2	0	2	0	2	0	0
2013 TOTAL	0	4	4	8	0	8	1	5	2	6	2	8	0	0
YEAR: 2012														
REAR-END	0	1	5	6	0	1	0	6	0	6	0	6	0	0
TURNING MOVEMENTS	0	0	1	1	0	0	0	1	0	0	1	1	0	0
2012 TOTAL	0	1	6	7	0	1	0	7	0	6	1	7	0	0
YEAR: 2011														
REAR-END	0	2	2	4	0	2	0	4	0	4	0	4	0	0
TURNING MOVEMENTS	0	0	1	1	0	0	0	0	1	0	1	1	0	0
2011 TOTAL	0	2	3	5	0	2	0	4	1	4	1	5	0	0
YEAR: 2010														
REAR-END	0	1	4	5	0	1	0	5	0	5	0	5	0	0
2010 TOTAL	0	1	4	5	0	1	0	5	0	5	0	5	0	0
YEAR: 2009														
MISCELLANEOUS	0	0	1	1	0	0	1	1	0	1	0	1	0	0
NON-COLLISION	0	1	0	1	0	1	0	1	0	1	0	1	0	0
REAR-END	0	1	2	3	0	1	0	3	0	3	0	3	0	0
SIDESWIPE - OVERTAKING	0	1	0	1	0	1	0	1	0	1	0	1	0	0
TURNING MOVEMENTS	0	1	1	2	0	1	1	2	0	2	0	2	0	0
2009 TOTAL	0	4	4	8	0	4	2	8	0	8	0	8	0	0
FINAL TOTAL	0	12	21	33	0	16	3	29	3	29	4	33	0	0

Disclaimer: A higher number of crashes may be reported as of 2011 compared to prior years. This does not reflect an increase in annual crashes. The higher numbers result from a change to an internal departmental process that allows the Crash Analysis and Reporting Unit to add previously unavailable, non-fatal crash reports to the annual data file. Please be aware of this change when comparing pre-2011 crash statistics.

CDS380 1/28/2015

OREGON DEPARTMENT OF TRANSPORTATION - TRANSPORTATION DEVELOPMENT DIVISION
 TRANSPORTATION DATA SECTION - CRASH ANALYSIS AND REPORTING UNIT
 CONTINUOUS SYSTEM CRASH LISTING

PAGE: 1

091 PACIFIC HIGHWAY WEST

Villa Road & OR 99W
 January 1, 2009 through December 31, 2013

SER#	S D P R S W E A U C O DATE E L G H R DAY INVEST D C S L K TIME	COUNTY CITY URBAN AREA	RD# FC COMPNT MLG TYP MILEPNT	CONN # FIRST STREET SECOND STREET	RD CHAR DIRECT LOCTN	INT-TYP (MEDIAN) INT-REL TRAF- CNTL	OFFRD WTHR RNDBT SURF COLL TYP	CRASH TYP SVRTY	SPCL USE TRLR QTY MOVE FROM TO	A S G E LICNS PED	PRTC INJ SVRVTY	E X RES LOC ERROR	ACTN EVENT	CAUSE
00184	N N N 02/27/2012	YAMHILL NEWBERG NEWBERG UA	1 14 0 0 22.89	PACIFIC HY 99W VILLA RD	INTER E 06	CROSS N TRF SIGNAL	N CLR N DRY N DAY	S-1STOP REAR PDO	01 NONE 0 STRGHT PRVTE PSNGR CAR	0 E W	01 DRVR NONE	31 F OR-Y OR<25	026 000	07,27 00 07,27
									02 NONE 0 STOP PRVTE PSNGR CAR	0 E W	01 DRVR NONE	41 F OR-Y OR<25	000 000	00 00
00600	N N N N N 08/12/2009	YAMHILL NEWBERG NEWBERG UA	1 14 0 0 22.89	PACIFIC HY 99W VILLA RD	INTER UN 06	CROSS N TRF SIGNAL	N CLR N DRY N DAY	O-1STOP OTH PDO	01 NONE 1 STRGHT PRVTE SEMI TOW	1 N S	01 DRVR NONE	50 M OR-Y OR>25	017 000	025,080 11 11 00
									02 NONE 0 STOP PRVTE PSNGR CAR	0 S N	01 DRVR NONE	25 M OR-Y OR<25	000 000	080 00 00
									03 NONE 0 STOP PRVTE PSNGR CAR	0 S N	01 DRVR NONE	36 M OR-Y OR<25	000 000	080 00 00
00420	N N N 04/17/2010	YAMHILL NEWBERG NEWBERG UA	1 14 0 0 22.89	PACIFIC HY 99W VILLA RD	INTER NE 06	CROSS N TRF SIGNAL	N CLR N DRY N DAY	S-1STOP REAR PDO	01 NONE 0 STRGHT PRVTE PSNGR CAR	0 NE SW	01 DRVR NONE	00 M UNK UNK	026 000	07 00 07
									02 NONE 0 STOP PRVTE PSNGR CAR	0 NE SW	01 DRVR NONE	31 M OR-Y OR<25	000 000	00 00
00852	N N N 10/03/2010	YAMHILL NEWBERG NEWBERG UA	1 14 0 0 22.89	PACIFIC HY 99W VILLA RD	INTER NE 06	CROSS N TRF SIGNAL	N CLR N DRY N DAY	S-1STOP REAR PDO	01 NONE 0 STRGHT PRVTE PSNGR CAR	0 NE SW	01 DRVR NONE	00 F UNK UNK	026 000	07 00 07
									02 NONE 0 STOP PRVTE PSNGR CAR	0 NE SW	01 DRVR NONE	27 F OR-Y OR<25	000 000	00 00
00701	N N N 08/30/2011	YAMHILL NEWBERG NEWBERG UA	1 14 0 0 22.89	PACIFIC HY 99W VILLA RD	INTER NE 06	CROSS N TRF SIGNAL	N CLR N DRY N DAY	S-1STOP REAR INJ	01 NONE 0 STRGHT PRVTE PSNGR CAR	0 NE SW	01 DRVR NONE	20 F OR-Y OR>25	026,045 000	07,13 00 07,13
									02 NONE 0 STOP PRVTE PSNGR CAR	0 NE SW	01 DRVR INJC	25 F OR-Y OR>25	000 000	00 00

OREGON DEPARTMENT OF TRANSPORTATION - TRANSPORTATION DEVELOPMENT DIVISION
 TRANSPORTATION DATA SECTION - CRASH ANALYSIS AND REPORTING UNIT
 CONTINUOUS SYSTEM CRASH LISTING

091 PACIFIC HIGHWAY WEST

Villa Road & OR 99W

January 1, 2009 through December 31, 2013

SER#	INVEST	S D P R S W	E A U C O DATE	COUNTY	RD# FC	COMPNT	CONN #	RD CHAR	INT-TYP	INT-REL	OFFRD WTHR	CRASH TYP	SPCL USE	MOVE	PRTC INJ	A S	LICNS	PED	ACTN	EVENT	CAUSE		
				URBAN AREA	MLG TYP	FIRST STREET	SECOND STREET	DIRECT	(MEDIAN)	LEGS	TRAF-CNTL	RNDBT SURF	COLL TYP	OWNER	FROM	E X	RES	LOC	ERROR				
00001	N N N N N		01/01/2012	YAMHILL	1 14			INTER	CROSS	N	N CLR	S-1STOP	01 NONE	0 STRGHT							32		
CITY			Sun	NEWBERG	0 0	PACIFIC HY 99W		NE		TRF SIGNAL	N DRY	REAR	PRVTE	NE SW					000		00		
			1P	NEWBERG UA	22.89	VILLA RD		06	0		N DAY	INJ	PSNGR CAR		01	DRVR	NONE	38 F	OR-Y	052,026	000	32	
													02 NONE	0 STOP									
													PRVTE	NE SW							011	00	
													PSNGR CAR		01	DRVR	INJC	33 F	OR-Y	000	000	00	
																						00	
00357	N N N		02/16/2012	YAMHILL	1 14			INTER	CROSS	N	N CLR	S-1STOP	01 NONE	0 STRGHT							07		
NONE			Thu	NEWBERG	0 0	HANCOCK ST		NE		TRF SIGNAL	N DRY	REAR	PRVTE	NE SW							000	00	
			UNK	NEWBERG UA	22.89	MERIDIAN ST		06	0		N DAY	PDO	PSNGR CAR		01	DRVR	NONE	18 F	OR-Y	026	000	07	
													02 NONE	0 STOP									
													PRVTE	NE SW								011	00
													PSNGR CAR		01	DRVR	NONE	00 F	UNK	000	000	00	
00468	N N N		05/22/2013	YAMHILL	1 14			INTER	CROSS	N	N UNK	S-1STOP	01 NONE	0 STRGHT							07		
NONE			Wed	NEWBERG	0 0	PACIFIC HY 99W		NE		TRF SIGNAL	N UNK	REAR	PRVTE	NE SW							000	00	
			8P	NEWBERG UA	22.89	VILLA RD		06	0		N DARK	PDO	PSNGR CAR		01	DRVR	NONE	71 F	OR-Y	026	000	07	
													02 NONE	0 STOP									
													PRVTE	NE SW								011	00
													PSNGR CAR		01	DRVR	NONE	46 M	OR-Y	000	000	00	
00436	N N N		05/29/2013	YAMHILL	1 14			INTER	CROSS	N	N CLR	S-1STOP	01 NONE	0 STRGHT							013	07	
NONE			Wed	NEWBERG	0 0	PACIFIC HY 99W		NE		TRF SIGNAL	N DRY	REAR	PRVTE	NE SW							000	00	
			12P	NEWBERG UA	22.89	VILLA RD		06	0		N DAY	INJ	PSNGR CAR		01	DRVR	NONE	00 F	UNK	026	000	07	
													02 NONE	0 STOP									
													PRVTE	NE SW								011	013
													PSNGR CAR		01	DRVR	NONE	00 M	UNK	000	000	00	
													03 NONE	STOP									
													PRVTE	NE SW								011	00
													PSNGR CAR		01	DRVR	INJC	43 F	OR-Y	000	000	00	
00453	N N N		06/02/2013	YAMHILL	1 14			INTER	CROSS	N	N CLR	S-1STOP	01 NONE	0 STRGHT								27,07	
CITY			Sun	NEWBERG	0 0	PACIFIC HY 99W		NE		TRF SIGNAL	N DRY	REAR	PRVTE	NE SW							000	00	
			5P	NEWBERG UA	22.89	VILLA RD		06	0		N DAY	INJ	PSNGR CAR		01	DRVR	NONE	45 F	OR-Y	026	000	27,07	
													02 NONE	0 STOP									
													PRVTE	NE SW								011	00
													PSNGR CAR		01	DRVR	INJC	27 M	OR-Y	000	000	00	

CDS380 1/28/2015

OREGON DEPARTMENT OF TRANSPORTATION - TRANSPORTATION DEVELOPMENT DIVISION
 TRANSPORTATION DATA SECTION - CRASH ANALYSIS AND REPORTING UNIT
 CONTINUOUS SYSTEM CRASH LISTING

PAGE: 3

091 PACIFIC HIGHWAY WEST

Villa Road & OR 99W
 January 1, 2009 through December 31, 2013

SER#	INVEST	S D P R S W E A U C O DATE E L G H R DAY D C S L K TIME	COUNTY CITY URBAN AREA	RD# FC COMPNT MLG TYP MILEPNT	CONN # FIRST STREET SECOND STREET	RD CHAR DIRECT LOCTN	INT-TYP (MEDIAN) LEGS (#LANES)	INT-REL TRAF- CNTL	OFFPRD RNDBT DRVWY	WTHR SURF LIGHT	CRASH TYP COLL TYP SVRTY	SPCL USE TRLR QTY OWNER VEH TYPE	MOVE FROM TO	PRTC TYPE	INJ SVRTY	A S G E X RES	LICNS E X RES	PED LOC ERROR	ACTN EVENT	CAUSE	
90872	N N N	09/26/2013 Thu 8P	YAMHILL NEWBERG NEWBERG UA	1 14 0 0 22.89	PACIFIC HY 99W VILLA RD	INTER NE 06	CROSS 0	N TRF SIGNAL	N N	RAIN WET DARK	S-1STOP REAR INJ	01 NONE PRVTE PSNGR CAR	0 STRGHT SW NE	02 PSNG 03 PSNG 04 PSNG	NO<5 INJC INJC	01 M 27 F 27 F			000 000 000	000 000 000	00 00 00
												02 NONE PRVTE PSNGR CAR	0 STOP SW NE						011 000	00 00	
00958	Y N N	10/28/2013 Mon 5P	YAMHILL NEWBERG NEWBERG UA	1 14 0 0 22.89	PACIFIC HY 99W VILLA RD	INTER NE 06	CROSS 0	N TRF SIGNAL	N N	CLR DRY DAY	S-1STOP REAR INJ	01 NONE PRVTE PSNGR CAR	0 STRGHT NE SW	01 DRVR NONE	NONE	39 F	OR-Y OR<25	038,047	026	27,01 00 27,01	
												02 NONE PRVTE PSNGR CAR	0 STOP NE SW						011 000	00 00	
93741	N N N	10/30/2009 Fri 1P	YAMHILL NEWBERG NEWBERG UA	1 14 0 0 22.89	PACIFIC HY 99W VILLA RD	INTER E 06	CROSS 0	N TRF SIGNAL	N N	CLR DRY DAY	S-1STOP REAR PDO	01 NONE PRVTE PSNGR CAR	0 STRGHT E W	01 DRVR NONE	NONE	32 M	OR-Y OR<25	026	000	07 00 07	
												02 NONE PRVTE PSNGR CAR	0 STOP E W						011 000	00 00	
													02 PSNG NONE	NO<5	02 M			000	000	00	
00414	N N N	06/14/2009 Sun 10A	YAMHILL NEWBERG NEWBERG UA	1 14 0 0 22.89	PACIFIC HY 99W VILLA RD	INTER S 06	CROSS 0	N TRF SIGNAL	N N	CLR DRY DAY	S-1STOP REAR INJ	01 NONE PRVTE PSNGR CAR	0 STRGHT S N	01 DRVR NONE	NONE	31 F	OR-Y OR<25	026	000	07 00 07	
												02 NONE PRVTE PSNGR CAR	0 STOP S N						011 000	00 00	
00587	N N N	07/17/2010 Sat 11A	YAMHILL NEWBERG NEWBERG UA	1 14 0 0 22.89	PACIFIC HY 99W VILLA RD	INTER S 06	CROSS 0	N TRF SIGNAL	N N	CLR DRY DAY	S-1STOP REAR PDO	01 NONE PRVTE PSNGR CAR	0 STRGHT S N	01 DRVR NONE	NONE	68 F	OR-Y OR<25	052,026	000	32 00 32	
												02 NONE PRVTE PSNGR CAR	0 STOP S N						011 000	00 00	

CDS380 1/28/2015

OREGON DEPARTMENT OF TRANSPORTATION - TRANSPORTATION DEVELOPMENT DIVISION
 TRANSPORTATION DATA SECTION - CRASH ANALYSIS AND REPORTING UNIT
 CONTINUOUS SYSTEM CRASH LISTING

PAGE: 4

091 PACIFIC HIGHWAY WEST

Villa Road & OR 99W
 January 1, 2009 through December 31, 2013

SER#	INVEST	S D P R S W E A U C O E L G H R D C S L K	DATE	COUNTY	RD# FC COMPNT MLG TYP MILEPNT	CONN # FIRST STREET SECOND STREET	RD CHAR DIRECT LOCTN	INT-TYP (MEDIAN) LEGS (#LANES)	INT-REL TRAF- CNTL	OFFRD RNDBT DRVWY	WTHR SURF LIGHT	CRASH TYP COLL TYP SVRTY	SPCL USE TRLR QTY OWNER VEH TYPE	MOVE FROM TO	PRTC P#	INJ SVRTY	A S G E E X	LICNS RES	PED LOC	ERROR	ACTN	EVENT	CAUSE	
00146	N N N		02/24/2013	YAMHILL	1 14		INTER	CROSS	N		N CLR	S-OTHER	01 NONE	0	TURN-L								08	
NONE			Sun	NEWBERG	0 0	PACIFIC HY 99W	S				N DRY	TURN	PRVTE	S W									00	
			5P	NEWBERG UA	22.89	VILLA RD	06	0			N DAY	PDO	PSNGR CAR		01	DRVR	NONE	52 M	OR-Y	006	000		08	
																		OR<25						
													02 NONE	0	TURN-L								00	
													PRVTE	S W									00	
													PSNGR CAR		01	DRVR	NONE	47 F	OR-Y	000	000		00	
																		OR<25					00	
00808	N N N N N		09/19/2012	YAMHILL	1 14		INTER	CROSS	N		N CLR	ANGL-OTH	01 NONE	0	TURN-L								32,08,13	
CITY			Wed	NEWBERG	0 0	PACIFIC HY 99W	SW		L-GRN-SIG		N DRY	TURN	PRVTE	S SW									00	
			9P	NEWBERG UA	22.89	VILLA RD	05	0			N DLIT	PDO	PSNGR CAR		01	DRVR	NONE	43 M	OR-Y	007	000		08	
																		OR>25						
													02 NONE	0	TURN-L								00	
													PRVTE	S SW									00	
													PSNGR CAR		01	DRVR	NONE	37 M	OR-Y	052,045	000		32,13	
																		OR>25						
00546	N N N		07/06/2010	YAMHILL	1 14		INTER	CROSS	N		N CLR	S-1STOP	01 NONE	0	STRGHT								07	
NO RPT			Tue	NEWBERG	0 0	PACIFIC HY 99W	SW		TRF SIGNAL		N DRY	REAR	PRVTE	SW NE									00	
			11A	NEWBERG UA	22.89	VILLA RD	06	0			N DAY	INJ	PSNGR CAR		01	DRVR	INJC	51 F	OR-Y	026	000		07	
																		OR<25						
													02 NONE	0	STOP								00	
													PRVTE	SW NE									00	
													PSNGR CAR		01	DRVR	NONE	41 M	OR-Y	000	000		00	
																		OR<25					00	
00863	N N N		10/25/2011	YAMHILL	1 14		INTER	CROSS	N		N CLR	S-1STOP	01 NONE	0	STRGHT								27,07	
NONE			Tue	NEWBERG	0 0	PACIFIC HY 99W	SW		TRF SIGNAL		N DRY	REAR	PRVTE	SW NE									00	
			8A	NEWBERG UA	22.89	VILLA RD	06	0			N DAY	INJ	PSNGR CAR		01	DRVR	NONE	23 M	OR-Y	026	000		07	
																		OR<25						
													02 NONE	0	STOP								00	
													PRVTE	SW NE									00	
													PSNGR CAR		01	DRVR	INJC	68 F	OR-Y	000	000		00	
																		OR<25					00	
00366	N N N		04/23/2012	YAMHILL	1 14		INTER	CROSS	N		N CLR	S-1STOP	01 NONE	0	STRGHT								07	
NO RPT			Mon	NEWBERG	0 0	PACIFIC HY 99W	SW		TRF SIGNAL		N DRY	REAR	PRVTE	SW NE									00	
			4P	NEWBERG UA	22.89	VILLA RD	06	0			N DAY	PDO	PSNGR CAR		01	DRVR	NONE	35 M	OTH-Y	026	000		07	
																		N-RES						
													02 NONE	0	STOP								00	
													PRVTE	SW NE									00	
													PSNGR CAR		01	DRVR	NONE	30 F	OR-Y	000	000		00	
																		OR<25					00	
																		02 PSNG	NO<5	04 M	000	000		00

CDS380 1/28/2015

OREGON DEPARTMENT OF TRANSPORTATION - TRANSPORTATION DEVELOPMENT DIVISION
 TRANSPORTATION DATA SECTION - CRASH ANALYSIS AND REPORTING UNIT
 CONTINUOUS SYSTEM CRASH LISTING

PAGE: 5

091 PACIFIC HIGHWAY WEST

Villa Road & OR 99W
 January 1, 2009 through December 31, 2013

SER#	INVEST	S D P R S W E A U C O E L G H R D C S L K	DATE	COUNTY	RD# FC COMPNT MLG TYP MILEPNT	CONN # FIRST STREET SECOND STREET	RD CHAR DIRECT LOCTN	INT-TYP (MEDIAN) LEGS (#LANES)	INT-REL TRAF- CNTL	OFFRD RNDBT DRVWY	WTHR SURF LIGHT	CRASH TYP COLL TYP SVRTY	SPCL USE TRLR QTY OWNER VEH TYPE	MOVE FROM TO	PRTC P#	INJ TYPE	A S G E X RES	LICNS RES	PED LOC	ERROR	ACTN EVENT	CAUSE	
00419	N N N		05/22/2012	YAMHILL	1 14		INTER	CROSS	N		N CLD	S-1STOP	01 NONE	0 STRGHT								07	
NONE			Tue	NEWBERG	0 0	PACIFIC HY 99W	SW		TRF SIGNAL	N DRY	REAR	PRVTE	SW NE								000	00	
			3P	NEWBERG UA	22.89	VILLA RD	06	0		N DAY	PDO	PSNGR CAR		01	DRVR	NONE	00 F	OR-Y	026	000	07	UNK	
												02 NONE	0 STOP									011	00
												PRVTE	SW NE								000	000	00
												PSNGR CAR		01	DRVR	NONE	41 M	OR-Y	000	000	000	00	OR<25
00468	N N N N N		06/11/2012	YAMHILL	1 14		INTER	CROSS	N		N CLR	S-1STOP	01 NONE	0 STRGHT								27	
CITY			Mon	NEWBERG	0 0	PACIFIC HY 99W	SW		TRF SIGNAL	N DRY	REAR	PRVTE	SW NE								000	00	
			4P	NEWBERG UA	22.89	VILLA RD	06	0		N DAY	PDO	PSNGR CAR		01	DRVR	NONE	18 M	OR-Y	026	000	000	27	
												02 NONE	0 STOP									011	00
												PRVTE	SW NE								000	000	00
												PSNGR CAR		01	DRVR	NONE	40 M	OR-Y	000	000	000	00	OR<25
00832	N N N N N		09/23/2013	YAMHILL	1 14		INTER	CROSS	N		N RAIN	S-1STOP	01 NONE	0 STRGHT								32,27	
CITY			Mon	NEWBERG	0 0	PACIFIC HY 99W	SW		TRF SIGNAL	N WET	REAR	PRVTE	SW NE								000	00	
			7A	NEWBERG UA	22.89	VILLA RD	06	0		N DAY	PDO	PSNGR CAR		01	DRVR	NONE	18 M	OR-Y	052	000	000	32,27	
												02 NONE	0 STOP									011	00
												PRVTE	SW NE								000	000	00
												PSNGR CAR		01	DRVR	NONE	35 F	OR-Y	000	000	000	00	OR<25
00485	N N N		06/30/2009	YAMHILL	1 14		INTER	CROSS	N		N CLR	S-1STOP	01 NONE	0 STRGHT								07	
NONE			Tue	NEWBERG	0 0	PACIFIC HY 99W	W		TRF SIGNAL	N DRY	REAR	PRVTE	SW NE								000	00	
			11A	NEWBERG UA	22.89	VILLA RD	06	0		N DAY	PDO	PSNGR CAR		01	DRVR	NONE	26 F	OR-Y	026	000	000	07	
												02 PSNG	NO<5								000	000	00
												02 NONE	0 STOP									011	00
												PRVTE	SW NE								000	000	00
												PSNGR CAR		01	DRVR	NONE	56 F	OR-Y	000	000	000	00	OR<25
00076	N N N		01/26/2011	YAMHILL	1 14		INTER	CROSS	N		N CLR	S-1STOP	01 NONE	0 STRGHT								07	
NONE			Wed	NEWBERG	0 0	PACIFIC HY 99W	W		TRF SIGNAL	N DRY	REAR	PRVTE	W E								000	00	
			3P	NEWBERG UA	22.89	VILLA RD	06	0		N DAY	PDO	PSNGR CAR		01	DRVR	NONE	00 M	OR-Y	026	000	000	07	
												02 NONE	0 STOP									011	00
												PRVTE	W E								000	000	00
												PSNGR CAR		01	DRVR	NONE	59 M	OR-Y	000	000	000	00	OR<25

OREGON DEPARTMENT OF TRANSPORTATION - TRANSPORTATION DEVELOPMENT DIVISION
 TRANSPORTATION DATA SECTION - CRASH ANALYSIS AND REPORTING UNIT
 CONTINUOUS SYSTEM CRASH LISTING

091 PACIFIC HIGHWAY WEST

Villa Road & OR 99W
 January 1, 2009 through December 31, 2013

SER#	INVEST	S D P R S W E A U C O E L G H R DAY D C S L K TIME	DATE	COUNTY CITY URBAN AREA	RD# FC COMPNT MLG TYP MILEPNT	CONN # FIRST STREET SECOND STREET	RD CHAR DIRECT LOCTN	INT-TYP (MEDIAN) LEGS (#LANES)	INT-REL TRAF- CNTL	OFFRD WTHR RNDBT SURF DRVWY LIGHT	CRASH TYP COLL TYP SVRTY	SPCL USE TRLR QTY OWNER VEH TYPE	MOVE FROM TO	PRTC INJ P# TYPE SVRTY	A S G E LICNS E X RES	PED LOC ERROR	ACTN EVENT	CAUSE
00241	N N N N N		03/31/2011	YAMHILL NEWBERG NEWBERG UA	1 14 0 0 22.89	PACIFIC HY 99W VILLA RD	INTER W 06	CROSS 0	N TRF SIGNAL	N CLR N DRY N DAY	S-1STOP REAR PDO	01 NONE PRVTE PSNGR CAR	0 STRGHT W E	01 DRVR NONE	19 F OR-Y OR<25	026	000 000	07 00 07
												02 NONE PRVTE PSNGR CAR	0 STOP W E	01 DRVR NONE	71 F OR-Y OR<25	000	011 000	00 00
00157	N N N NO RPT		02/26/2009	YAMHILL NEWBERG NEWBERG UA	1 14 0 0 22.89	PACIFIC HY 99W VILLA RD	INTER CN 01	CROSS 0	N TRF SIGNAL	N CLR N DRY N DAY	ANGL-OTH TURN INJ	01 NONE PRVTE PSNGR CAR	0 TURN-L N E	01 DRVR INJC	20 F OR-Y OR<25	028	000 000	02 00 02
												02 NONE PRVTE PSNGR CAR	0 STRGHT E W	01 DRVR NONE	34 M OTH-Y N-RES	000	000 000	00 00
01033	Y N N N N CITY		12/05/2009	YAMHILL NEWBERG NEWBERG UA	1 14 0 0 22.89	PACIFIC HY 99W VILLA RD	INTER CN 01	CROSS 0	N TRF SIGNAL	N CLR N DRY N DAY	OVERTURN NCOL INJ	01 NONE PRVTE PSNGR CAR	0 TURN-L S W	01 DRVR NONE	29 M OR-Y OR<25	080,052	000 000	01,32 00 01,32
														02 PSNG INJB	00 M	000	000	00
01150	N N N N N CITY		12/17/2013	YAMHILL NEWBERG NEWBERG UA	1 14 0 0 22.89	PACIFIC HY 99W VILLA RD	INTER CN 01	CROSS 0	N TRF SIGNAL	N CLR N DRY N DAY	S-OTHER TURN PDO	01 FARM PRVTE SEMI TOW	2 TURN-L SE SW	01 DRVR NONE	51 M OR-Y OR>25	007	000 000	08 00 08
												02 NONE PRVTE PSNGR CAR	0 TURN-L SE SW	01 DRVR NONE	47 F OR-Y OR<25	000	000 000	00 00
00491	N N N NONE		07/16/2009	YAMHILL NEWBERG NEWBERG UA	1 14 0 0 22.89	PACIFIC HY 99W VILLA RD	INTER CN 02	CROSS 0	N UNKNOWN	N CLR N DRY N DAY	S-STRGHT SS-O INJ	01 NONE PRVTE PSNGR CAR	0 STRGHT E W	01 DRVR NONE	26 F OR-Y OR<25	080	000 000	13 00 13
												02 NONE PRVTE PSNGR CAR	0 STRGHT E W	01 DRVR INJC	24 M OTH-Y OR<25	000	000 000	00 00
01023	N N N NO RPT		12/08/2009	YAMHILL NEWBERG NEWBERG UA	1 14 0 0 22.89	PACIFIC HY 99W VILLA RD	INTER CN 04	CROSS 0	N UNKNOWN	N CLR N DRY N DAY	S-OTHER TURN PDO	01 NONE PRVTE PSNGR CAR	0 TURN-R S NE	01 DRVR NONE	51 F OR-Y OR>25	006	000 000	08 00 08

CDS380 1/28/2015

OREGON DEPARTMENT OF TRANSPORTATION - TRANSPORTATION DEVELOPMENT DIVISION
 TRANSPORTATION DATA SECTION - CRASH ANALYSIS AND REPORTING UNIT
 CONTINUOUS SYSTEM CRASH LISTING

PAGE: 7

091 PACIFIC HIGHWAY WEST

Villa Road & OR 99W
 January 1, 2009 through December 31, 2013

SER#	E L G H R DAY	COUNTY	RD# FC	COMPNT	CONN #	RD CHAR	INT-TYP	INT-REL	OFFRD WTHR	CRASH TYP	SPCL USE	MOVE	A S	PED	ACTN	CAUSE
INVEST	D C S L K TIME	URBAN AREA	MILEPNT	FIRST STREET	SECOND STREET	DIRECT	(#LANES)	TRAF- CNTL	RNDBT SURF	COLL TYP	OWNER	FROM	PRTC INJ	G E LICNS	LOC	ERROR
											02 NONE 3 TURN-R					
											PRVTE S NE					000
											SEMI TOW		01 DRVR NONE	40 M OR-Y		000
																OR>25
00878	NNN 10/28/2011	YAMHILL	1 14			INTER	CROSS N		N RAIN S-OTHER		01 NONE 0 TURN-R					
NONE	Fri NEWBERG		0 0	PACIFIC HY 99W		CN	TRF SIGNAL		N WET TURN		PRVTE S E					000
	8P NEWBERG UA		22.89	VILLA RD		04	0		N DARK PDO		PSNGR CAR		01 DRVR NONE	17 F OR-Y		080
																OR<25
											02 NONE 0 TURN-R					
											PRVTE S E					000
											PSNGR CAR		01 DRVR NONE	00 U UNK		000
																UNK

OREGON DEPARTMENT OF TRANSPORTATION - TRANSPORTATION DEVELOPMENT DIVISION
TRANSPORTATION DATA SECTION - CRASH ANALYSIS AND REPORTING UNIT
CRASH SUMMARIES BY YEAR BY COLLISION TYPE

Villa Road & Park Lane
January 1, 2009 through December 31, 2013

COLLISION TYPE	FATAL CRASHES	NON- FATAL CRASHES	PROPERTY DAMAGE ONLY	TOTAL CRASHES	PEOPLE KILLED	PEOPLE INJURED	TRUCKS	DRY SURF	WET SURF	DAY	DARK	INTER- SECTION	INTER- SECTION RELATED	OFF- ROAD
----------------	------------------	--------------------------	----------------------------	------------------	------------------	-------------------	--------	-------------	-------------	-----	------	-------------------	------------------------------	--------------

YEAR:

TOTAL

FINAL TOTAL

Disclaimer: A higher number of crashes may be reported as of 2011 compared to prior years. This does not reflect an increase in annual crashes. The higher numbers result from a change to an internal departmental process that allows the Crash Analysis and Reporting Unit to add previously unavailable, non-fatal crash reports to the annual data file. Please be aware of this change when comparing pre-2011 crash statistics.

OREGON DEPARTMENT OF TRANSPORTATION - TRANSPORTATION DEVELOPMENT DIVISION
TRANSPORTATION DATA SECTION - CRASH ANALYSIS AND REPORTING UNIT
CRASH SUMMARIES BY YEAR BY COLLISION TYPE

Aldersgate Lane from Park Lane to Crestview Drive (excludes ending intersections)
January 1, 2009 through December 31, 2013

COLLISION TYPE	FATAL CRASHES	NON- FATAL CRASHES	PROPERTY DAMAGE ONLY	TOTAL CRASHES	PEOPLE KILLED	PEOPLE INJURED	TRUCKS	DRY SURF	WET SURF	DAY	DARK	INTER- SECTION	INTER- SECTION RELATED	OFF- ROAD
----------------	------------------	--------------------------	----------------------------	------------------	------------------	-------------------	--------	-------------	-------------	-----	------	-------------------	------------------------------	--------------

YEAR:

TOTAL

FINAL TOTAL

Disclaimer: A higher number of crashes may be reported as of 2011 compared to prior years. This does not reflect an increase in annual crashes. The higher numbers result from a change to an internal departmental process that allows the Crash Analysis and Reporting Unit to add previously unavailable, non-fatal crash reports to the annual data file. Please be aware of this change when comparing pre-2011 crash statistics.

OREGON DEPARTMENT OF TRANSPORTATION - TRANSPORTATION DEVELOPMENT DIVISION
 TRANSPORTATION DATA SECTION - CRASH ANALYSIS AND REPORTING UNIT
 CRASH SUMMARIES BY YEAR BY COLLISION TYPE

Villa Road from Park Lane to OR 99W (excludes ending intersections)
 January 1, 2009 through December 31, 2013

COLLISION TYPE	FATAL CRASHES	NON- FATAL CRASHES	PROPERTY DAMAGE ONLY	TOTAL CRASHES	PEOPLE KILLED	PEOPLE INJURED	TRUCKS	DRY SURF	WET SURF	DAY	DARK	INTER- SECTION	INTER- SECTION RELATED	OFF- ROAD
YEAR: 2012														
TURNING MOVEMENTS	0	1	0	1	0	1	0	1	0	1	0	0	0	0
2012 TOTAL	0	1	0	1	0	1	0	1	0	1	0	0	0	0
YEAR: 2011														
TURNING MOVEMENTS	0	1	0	1	0	1	0	1	0	1	0	0	0	0
2011 TOTAL	0	1	0	1	0	1	0	1	0	1	0	0	0	0
YEAR: 2010														
ANGLE	0	0	1	1	0	0	0	1	0	1	0	0	0	1
REAR-END	0	1	0	1	0	1	0	1	0	1	0	0	0	1
2010 TOTAL	0	1	1	2	0	1	0	2	0	2	0	0	0	2
FINAL TOTAL	0	3	1	4	0	3	0	4	0	4	0	0	0	2

Disclaimer: A higher number of crashes may be reported as of 2011 compared to prior years. This does not reflect an increase in annual crashes. The higher numbers result from a change to an internal departmental process that allows the Crash Analysis and Reporting Unit to add previously unavailable, non-fatal crash reports to the annual data file. Please be aware of this change when comparing pre-2011 crash statistics.

Appendix E Year 2016 Background Traffic
Level-of-Service Worksheets

2016 Background Traffic AM Peak Hour
1: Aldersgate Ln & E Crestview Dr



Movement	EBT	EBR	WBL	WBT	NBL	NBR
Lane Configurations	↔			↔	↔	
Volume (veh/h)	166	2	2	92	3	5
Sign Control	Free			Free	Stop	
Grade	0%			0%	0%	
Peak Hour Factor	0.63	0.63	0.63	0.63	0.63	0.63
Hourly flow rate (vph)	263	3	3	146	5	8
Pedestrians	4				3	
Lane Width (ft)	12.0				12.0	
Walking Speed (ft/s)	4.0				4.0	
Percent Blockage	0				0	
Right turn flare (veh)						
Median type	None			None		
Median storage (veh)						
Upstream signal (ft)						
pX, platoon unblocked						
vC, conflicting volume			270		424	268
vC1, stage 1 conf vol						
vC2, stage 2 conf vol						
vCu, unblocked vol			270		424	268
tC, single (s)			4.1		6.4	6.2
tC, 2 stage (s)						
tF (s)			2.2		3.5	3.3
p0 queue free %			100		99	99
cM capacity (veh/h)			1302		585	774
Direction, Lane #	EB 1	WB 1	NB 1			
Volume Total	267	149	13			
Volume Left	0	3	5			
Volume Right	3	0	8			
cSH	1700	1302	690			
Volume to Capacity	0.16	0.00	0.02			
Queue Length 95th (ft)	0	0	1			
Control Delay (s)	0.0	0.2	10.3			
Lane LOS		A	B			
Approach Delay (s)	0.0	0.2	10.3			
Approach LOS			B			
Intersection Summary						
Average Delay			0.4			
Intersection Capacity Utilization			19.3%	ICU Level of Service		A
Analysis Period (min)			15			

2016 Background Traffic AM Peak Hour
2: Aldersgate Ln & Park Ln











Movement	WBL	WBR	NBT	NBR	SBL	SBT
Lane Configurations	Y		B			4
Volume (veh/h)	9	0	5	35	5	2
Sign Control	Stop		Free			Free
Grade	0%		0%			0%
Peak Hour Factor	0.77	0.77	0.77	0.77	0.77	0.77
Hourly flow rate (vph)	12	0	6	45	6	3
Pedestrians	1					
Lane Width (ft)	12.0					
Walking Speed (ft/s)	4.0					
Percent Blockage	0					
Right turn flare (veh)						
Median type			None			None
Median storage (veh)						
Upstream signal (ft)						
pX, platoon unblocked						
vC, conflicting volume	46	30			53	
vC1, stage 1 conf vol						
vC2, stage 2 conf vol						
vCu, unblocked vol	46	30			53	
tC, single (s)	6.4	6.2			4.1	
tC, 2 stage (s)						
tF (s)	3.5	3.3			2.2	
p0 queue free %	99	100			100	
cM capacity (veh/h)	965	1049			1564	

















Direction, Lane #	WB 1	NB 1	SB 1
Volume Total	12	52	9
Volume Left	12	0	6
Volume Right	0	45	0
cSH	965	1700	1564
Volume to Capacity	0.01	0.03	0.00
Queue Length 95th (ft)	1	0	0
Control Delay (s)	8.8	0.0	5.2
Lane LOS	A		A
Approach Delay (s)	8.8	0.0	5.2
Approach LOS	A		

Intersection Summary			
Average Delay		2.1	
Intersection Capacity Utilization		14.5%	ICU Level of Service A
Analysis Period (min)		15	

























2016 Background Traffic AM Peak Hour
4: Villa Rd & Park Ln

						
Movement	EBL	EBR	NBL	NBT	SBT	SBR
Lane Configurations						
Volume (veh/h)	1	43	10	156	287	0
Sign Control	Stop			Free	Free	
Grade	0%			0%	0%	
Peak Hour Factor	0.69	0.69	0.69	0.69	0.69	0.69
Hourly flow rate (vph)	1	62	14	226	416	0
Pedestrians				1	2	
Lane Width (ft)				12.0	12.0	
Walking Speed (ft/s)				4.0	4.0	
Percent Blockage				0	0	
Right turn flare (veh)						
Median type				None	None	
Median storage (veh)						
Upstream signal (ft)						
pX, platoon unblocked						
vC, conflicting volume	673	417	416			
vC1, stage 1 conf vol						
vC2, stage 2 conf vol						
vCu, unblocked vol	673	417	416			
tC, single (s)	6.4	6.2	4.1			
tC, 2 stage (s)						
tF (s)	3.5	3.3	2.2			
p0 queue free %	100	90	99			
cM capacity (veh/h)	418	640	1154			
Direction, Lane #	EB 1	NB 1	SB 1			
Volume Total	64	241	416			
Volume Left	1	14	0			
Volume Right	62	0	0			
cSH	632	1154	1700			
Volume to Capacity	0.10	0.01	0.24			
Queue Length 95th (ft)	8	1	0			
Control Delay (s)	11.3	0.6	0.0			
Lane LOS	B	A				
Approach Delay (s)	11.3	0.6	0.0			
Approach LOS	B					
Intersection Summary						
Average Delay			1.2			
Intersection Capacity Utilization		26.7%		ICU Level of Service		A
Analysis Period (min)			15			

2016 Background Traffic AM Peak Hour
6: Villa Rd & Fulton St

												
Movement	EBL	EBT	EBR	WBL	WBT	WBR	NBL	NBT	NBR	SBL	SBT	SBR
Lane Configurations												
Volume (veh/h)	137	1	65	2	1	1	75	102	5	5	191	79
Sign Control		Stop			Stop			Free			Free	
Grade		0%			0%			0%			0%	
Peak Hour Factor	0.84	0.84	0.84	0.84	0.84	0.84	0.84	0.84	0.84	0.84	0.84	0.84
Hourly flow rate (vph)	163	1	77	2	1	1	89	121	6	6	227	94
Pedestrians		15			3			2			3	
Lane Width (ft)		12.0			12.0			12.0			12.0	
Walking Speed (ft/s)		4.0			4.0			4.0			4.0	
Percent Blockage		1			0			0			0	
Right turn flare (veh)			6									
Median type								None			None	
Median storage (veh)												
Upstream signal (ft)												
pX, platoon unblocked												
vC, conflicting volume	609	610	291	634	654	130	336			130		
vC1, stage 1 conf vol												
vC2, stage 2 conf vol												
vCu, unblocked vol	609	610	291	634	654	130	336			130		
tC, single (s)	7.1	6.5	6.2	7.1	6.5	6.2	4.1			4.1		
tC, 2 stage (s)												
tF (s)	3.5	4.0	3.3	3.5	4.0	3.3	2.2			2.2		
p0 queue free %	56	100	90	99	100	100	93			100		
cM capacity (veh/h)	373	374	737	327	353	920	1219			1464		
Direction, Lane #	EB 1	WB 1	NB 1	SB 1								
Volume Total	242	5	217	327								
Volume Left	163	2	89	6								
Volume Right	77	1	6	94								
cSH	549	398	1219	1464								
Volume to Capacity	0.44	0.01	0.07	0.00								
Queue Length 95th (ft)	56	1	6	0								
Control Delay (s)	18.3	14.1	3.8	0.2								
Lane LOS	C	B	A	A								
Approach Delay (s)	18.3	14.1	3.8	0.2								
Approach LOS	C	B										
Intersection Summary												
Average Delay			6.8									
Intersection Capacity Utilization			49.2%		ICU Level of Service					A		
Analysis Period (min)			15									

2016 Background Traffic AM Peak Hour
7: Villa Rd & Hwy 99W

												
Movement	EBL	EBT	EBR	WBL	WBT	WBR	NBL	NBT	NBR	SBL	SBT	SBR
Lane Configurations		 			 			 			 	
Volume (vph)	100	1381	2	8	956	105	391	70	10	131	67	54
Ideal Flow (vphpl)	1900	1900	1900	1900	1900	1900	1900	1900	1900	1900	1900	1900
Total Lost time (s)	4.5	4.5		4.5	4.5		4.5	5.0		4.5	5.0	5.0
Lane Util. Factor	1.00	0.95		1.00	0.91		0.97	1.00		1.00	1.00	1.00
Frbp, ped/bikes	1.00	1.00		1.00	1.00		1.00	1.00		1.00	1.00	1.00
Flpb, ped/bikes	1.00	1.00		1.00	1.00		1.00	1.00		1.00	1.00	1.00
Frt	1.00	1.00		1.00	0.99		1.00	0.98		1.00	1.00	0.85
Flt Protected	0.95	1.00		0.95	1.00		0.95	1.00		0.95	1.00	1.00
Satd. Flow (prot)	1805	3438		1805	4635		2968	1670		1752	1900	1583
Flt Permitted	0.95	1.00		0.95	1.00		0.95	1.00		0.95	1.00	1.00
Satd. Flow (perm)	1805	3438		1805	4635		2968	1670		1752	1900	1583
Peak-hour factor, PHF	0.90	0.90	0.90	0.90	0.90	0.90	0.90	0.90	0.90	0.90	0.90	0.90
Adj. Flow (vph)	111	1534	2	9	1062	117	434	78	11	146	74	60
RTOR Reduction (vph)	0	0	0	0	7	0	0	8	0	0	0	55
Lane Group Flow (vph)	111	1536	0	9	1172	0	434	81	0	146	74	5
Confl. Peds. (#/hr)	1		2	2		1			2	2		
Heavy Vehicles (%)	0%	5%	0%	0%	11%	1%	18%	10%	22%	3%	0%	2%
Turn Type	Prot	NA		Prot	NA		Prot	NA		Prot	NA	Perm
Protected Phases	7	4		3	8		5	2		1	6	
Permitted Phases												6
Actuated Green, G (s)	11.0	61.7		1.3	52.0		10.9	10.6		7.9	7.6	7.6
Effective Green, g (s)	11.0	61.7		1.3	52.0		10.9	10.6		7.9	7.6	7.6
Actuated g/C Ratio	0.11	0.62		0.01	0.52		0.11	0.11		0.08	0.08	0.08
Clearance Time (s)	4.5	4.5		4.5	4.5		4.5	5.0		4.5	5.0	5.0
Vehicle Extension (s)	2.5	2.5		2.5	2.5		2.5	4.2		2.5	4.2	4.2
Lane Grp Cap (vph)	198	2121		23	2410		323	177		138	144	120
v/s Ratio Prot	c0.06	c0.45		0.00	0.25		c0.15	c0.05		0.08	0.04	
v/s Ratio Perm												0.00
v/c Ratio	0.56	0.72		0.39	0.49		1.34	0.46		1.06	0.51	0.04
Uniform Delay, d1	42.2	13.3		49.0	15.4		44.5	42.0		46.0	44.4	42.8
Progression Factor	1.00	1.00		1.00	1.00		1.00	1.00		1.00	1.00	1.00
Incremental Delay, d2	2.9	1.2		7.8	0.1		174.0	8.3		92.9	12.5	0.6
Delay (s)	45.1	14.4		56.8	15.5		218.6	50.3		139.0	56.9	43.4
Level of Service	D	B		E	B		F	D		F	E	D
Approach Delay (s)		16.5			15.8			189.9			96.8	
Approach LOS		B			B			F			F	
Intersection Summary												
HCM 2000 Control Delay			47.4				HCM 2000 Level of Service				D	
HCM 2000 Volume to Capacity ratio			0.79									
Actuated Cycle Length (s)			100.0				Sum of lost time (s)			18.5		
Intersection Capacity Utilization			79.1%				ICU Level of Service			D		
Analysis Period (min)			15									
c Critical Lane Group												

2016 Background Traffic AM Peak Hour
7: Villa Rd & Hwy 99W

Movement	EBL	EBT	EBR	WBL	WBT	WBR	NBL	NBT	NBR	SBL	SBT	SBR
Lane Configurations												
Volume (veh/h)	100	1381	2	8	956	105	391	70	10	131	67	54
Number	7	4	14	3	8	18	5	2	12	1	6	16
Initial Q (Qb), veh	0	0	0	0	0	0	0	0	0	0	0	0
Ped-Bike Adj(A_pbT)	1.00		1.00	1.00		1.00	1.00		1.00	1.00		1.00
Parking Bus, Adj	1.00	1.00	1.00	1.00	1.00	1.00	1.00	1.00	1.00	1.00	1.00	1.00
Adj Sat Flow, veh/h/ln	1900	1810	1900	1900	1727	1900	1610	1704	1900	1845	1900	1863
Adj Flow Rate, veh/h	111	1534	2	9	1062	117	434	78	11	146	74	60
Adj No. of Lanes	1	2	0	1	3	0	2	1	0	1	1	1
Peak Hour Factor	0.90	0.90	0.90	0.90	0.90	0.90	0.90	0.90	0.90	0.90	0.90	0.90
Percent Heavy Veh, %	0	5	5	0	11	11	18	10	10	3	0	2
Cap, veh/h	138	1162	2	23	1150	127	260	644	91	110	789	657
Arrive On Green	0.08	0.33	0.33	0.01	0.27	0.27	0.09	0.44	0.44	0.06	0.42	0.42
Sat Flow, veh/h	1810	3523	5	1810	4311	474	2975	1461	206	1757	1900	1581
Grp Volume(v), veh/h	111	748	788	9	774	405	434	0	89	146	74	60
Grp Sat Flow(s),veh/h/ln	1810	1719	1809	1810	1572	1641	1487	0	1668	1757	1900	1581
Q Serve(g_s), s	7.2	39.6	39.6	0.6	28.7	28.8	10.5	0.0	3.8	7.5	2.8	2.8
Cycle Q Clear(g_c), s	7.2	39.6	39.6	0.6	28.7	28.8	10.5	0.0	3.8	7.5	2.8	2.8
Prop In Lane	1.00		0.00	1.00		0.29	1.00		0.12	1.00		1.00
Lane Grp Cap(c), veh/h	138	567	597	23	839	438	260	0	735	110	789	657
V/C Ratio(X)	0.81	1.32	1.32	0.38	0.92	0.92	1.67	0.00	0.12	1.33	0.09	0.09
Avail Cap(c_a), veh/h	279	567	597	279	891	465	260	0	735	110	789	657
HCM Platoon Ratio	1.00	1.00	1.00	1.00	1.00	1.00	1.00	1.00	1.00	1.00	1.00	1.00
Upstream Filter(I)	1.00	1.00	1.00	1.00	1.00	1.00	1.00	0.00	1.00	1.00	1.00	1.00
Uniform Delay (d), s/veh	54.6	40.2	40.2	58.7	42.8	42.8	54.8	0.0	19.8	56.3	21.3	21.3
Incr Delay (d2), s/veh	8.0	155.9	155.4	7.5	14.2	23.4	316.6	0.0	0.3	197.9	0.2	0.3
Initial Q Delay(d3),s/veh	0.0	0.0	0.0	0.0	0.0	0.0	0.0	0.0	0.0	0.0	0.0	0.0
%ile BackOfQ(50%),veh/ln	3.9	43.3	45.5	0.3	14.1	15.9	15.8	0.0	1.8	9.7	1.6	1.3
LnGrp Delay(d),s/veh	62.6	196.1	195.6	66.2	57.0	66.2	371.4	0.0	20.2	254.2	21.6	21.6
LnGrp LOS	E	F	F	E	E	E	F		C	F	C	C
Approach Vol, veh/h		1647			1188			523				280
Approach Delay, s/veh		186.9			60.2			311.6				142.9
Approach LOS		F			E			F				F
Timer	1	2	3	4	5	6	7	8				
Assigned Phs	1	2	3	4	5	6	7	8				
Phs Duration (G+Y+Rc), s	12.0	57.9	6.1	44.1	15.0	54.9	13.6	36.5				
Change Period (Y+Rc), s	4.5	5.0	4.5	4.5	4.5	5.0	4.5	4.5				
Max Green Setting (Gmax), s	7.5	42.0	18.5	31.0	10.5	39.0	18.5	34.0				
Max Q Clear Time (g_c+I1), s	9.5	5.8	2.6	41.6	12.5	4.8	9.2	30.8				
Green Ext Time (p_c), s	0.0	1.8	0.0	0.0	0.0	1.8	0.1	1.2				
Intersection Summary												
HCM 2010 Ctrl Delay			160.1									
HCM 2010 LOS			F									

2016 BackgroundTraffic PM Peak Hour
1: Aldersgate Ln & E Crestview Dr



Movement	EBT	EBR	WBL	WBT	NBL	NBR
Lane Configurations	↔			↔	↔	
Volume (veh/h)	63	5	3	127	2	2
Sign Control	Free			Free	Stop	
Grade	0%			0%	0%	
Peak Hour Factor	0.63	0.63	0.63	0.63	0.63	0.63
Hourly flow rate (vph)	100	8	5	202	3	3
Pedestrians	4				3	
Lane Width (ft)	12.0				12.0	
Walking Speed (ft/s)	4.0				4.0	
Percent Blockage	0				0	
Right turn flare (veh)						
Median type	None			None		
Median storage (veh)						
Upstream signal (ft)						
pX, platoon unblocked						
vC, conflicting volume			111		322	107
vC1, stage 1 conf vol						
vC2, stage 2 conf vol						
vCu, unblocked vol			111		322	107
tC, single (s)			4.1		6.4	6.2
tC, 2 stage (s)						
tF (s)			2.2		3.5	3.3
p0 queue free %			100		100	100
cM capacity (veh/h)			1488		670	950
Direction, Lane #	EB 1	WB 1	NB 1			
Volume Total	108	206	6			
Volume Left	0	5	3			
Volume Right	8	0	3			
cSH	1700	1488	786			
Volume to Capacity	0.06	0.00	0.01			
Queue Length 95th (ft)	0	0	1			
Control Delay (s)	0.0	0.2	9.6			
Lane LOS		A	A			
Approach Delay (s)	0.0	0.2	9.6			
Approach LOS			A			
Intersection Summary						
Average Delay			0.3			
Intersection Capacity Utilization			19.1%	ICU Level of Service		A
Analysis Period (min)			15			

2016 BackgroundTraffic PM Peak Hour
2: Aldersgate Ln & Park Ln



Movement	WBL	WBR	NBT	NBR	SBL	SBT
Lane Configurations	Y		T			T
Volume (veh/h)	57	8	2	20	8	1
Sign Control	Stop		Free			Free
Grade	0%		0%			0%
Peak Hour Factor	0.77	0.77	0.77	0.77	0.77	0.77
Hourly flow rate (vph)	74	10	3	26	10	1
Pedestrians	1					
Lane Width (ft)	12.0					
Walking Speed (ft/s)	4.0					
Percent Blockage	0					
Right turn flare (veh)						
Median type			None			None
Median storage (veh)						
Upstream signal (ft)						
pX, platoon unblocked						
vC, conflicting volume	39	17			30	
vC1, stage 1 conf vol						
vC2, stage 2 conf vol						
vCu, unblocked vol	39	17			30	
tC, single (s)	6.4	6.2			4.1	
tC, 2 stage (s)						
tF (s)	3.5	3.3			2.2	
p0 queue free %	92	99			99	
cM capacity (veh/h)	971	1067			1595	

Direction, Lane #	WB 1	NB 1	SB 1
Volume Total	84	29	12
Volume Left	74	0	10
Volume Right	10	26	0
cSH	982	1700	1595
Volume to Capacity	0.09	0.02	0.01
Queue Length 95th (ft)	7	0	0
Control Delay (s)	9.0	0.0	6.5
Lane LOS	A		A
Approach Delay (s)	9.0	0.0	6.5
Approach LOS	A		





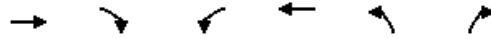



Intersection Summary			
Average Delay		6.7	
Intersection Capacity Utilization		17.2%	ICU Level of Service A
Analysis Period (min)		15	

2016 BackgroundTraffic PM Peak Hour
3: Site Access & Park Ln



Movement	EBT	EBR	WBL	WBT	NBL	NBR
Lane Configurations	↔			↔	↔	
Volume (veh/h)	31	0	0	65	0	0
Sign Control	Free			Free	Stop	
Grade	0%			0%	0%	
Peak Hour Factor	0.85	0.85	0.85	0.85	0.85	0.85
Hourly flow rate (vph)	36	0	0	76	0	0
Pedestrians				8		
Lane Width (ft)				12.0		
Walking Speed (ft/s)				4.0		
Percent Blockage				1		
Right turn flare (veh)						
Median type	None			None		
Median storage (veh)						
Upstream signal (ft)						
pX, platoon unblocked						
vC, conflicting volume			36		113	44
vC1, stage 1 conf vol						
vC2, stage 2 conf vol						
vCu, unblocked vol			36		113	44
tC, single (s)			4.1		6.4	6.2
tC, 2 stage (s)						
tF (s)			2.2		3.5	3.3
p0 queue free %			100		100	100
cM capacity (veh/h)			1587		889	1024
Direction, Lane #	EB 1	WB 1	NB 1			
Volume Total	36	76	0			
Volume Left	0	0	0			
Volume Right	0	0	0			
cSH	1700	1587	1700			
Volume to Capacity	0.02	0.00	0.00			
Queue Length 95th (ft)	0	0	0			
Control Delay (s)	0.0	0.0	0.0			
Lane LOS			A			
Approach Delay (s)	0.0	0.0	0.0			
Approach LOS			A			
Intersection Summary						
Average Delay			0.0			
Intersection Capacity Utilization			15.8%		ICU Level of Service	A
Analysis Period (min)			15			

2016 BackgroundTraffic PM Peak Hour
4: Villa Rd & Park Ln

















						
Movement	EBL	EBR	NBL	NBT	SBT	SBR
Lane Configurations						
Volume (veh/h)	1	29	59	245	173	6
Sign Control	Stop			Free	Free	
Grade	0%			0%	0%	
Peak Hour Factor	0.69	0.69	0.69	0.69	0.69	0.69
Hourly flow rate (vph)	1	42	86	355	251	9
Pedestrians				1	2	
Lane Width (ft)				12.0	12.0	
Walking Speed (ft/s)				4.0	4.0	
Percent Blockage				0	0	
Right turn flare (veh)						
Median type				None	None	
Median storage (veh)						
Upstream signal (ft)						
pX, platoon unblocked						
vC, conflicting volume	783	256	259			
vC1, stage 1 conf vol						
vC2, stage 2 conf vol						
vCu, unblocked vol	783	256	259			
tC, single (s)	6.4	6.2	4.1			
tC, 2 stage (s)						
tF (s)	3.5	3.3	2.2			
p0 queue free %	100	95	94			
cM capacity (veh/h)	341	787	1317			
Direction, Lane #	EB 1	NB 1	SB 1			
Volume Total	43	441	259			
Volume Left	1	86	0			
Volume Right	42	0	9			
cSH	754	1317	1700			
Volume to Capacity	0.06	0.06	0.15			
Queue Length 95th (ft)	5	5	0			
Control Delay (s)	10.1	2.1	0.0			
Lane LOS	B	A				
Approach Delay (s)	10.1	2.1	0.0			
Approach LOS	B					
Intersection Summary						
Average Delay			1.8			
Intersection Capacity Utilization		39.3%		ICU Level of Service		A
Analysis Period (min)			15			

2016 BackgroundTraffic PM Peak Hour
5: SITE Access & Park Ln



























Movement	EBL	EBR	NBL	NBT	SBT	SBR
Lane Configurations						
Volume (veh/h)	0	0	0	304	203	0
Sign Control	Stop			Free	Free	
Grade	0%			0%	0%	
Peak Hour Factor	0.85	0.85	0.85	0.85	0.85	0.85
Hourly flow rate (vph)	0	0	0	358	239	0
Pedestrians				1	2	
Lane Width (ft)				12.0	12.0	
Walking Speed (ft/s)				4.0	4.0	
Percent Blockage				0	0	
Right turn flare (veh)						
Median type				None	None	
Median storage (veh)						
Upstream signal (ft)						
pX, platoon unblocked						
vC, conflicting volume	598	240	239			
vC1, stage 1 conf vol						
vC2, stage 2 conf vol						
vCu, unblocked vol	598	240	239			
tC, single (s)	6.4	6.2	4.1			
tC, 2 stage (s)						
tF (s)	3.5	3.3	2.2			
p0 queue free %	100	100	100			
cM capacity (veh/h)	467	803	1340			
Direction, Lane #	EB 1	NB 1	SB 1			
Volume Total	0	358	239			
Volume Left	0	0	0			
Volume Right	0	0	0			
cSH	1700	1340	1700			
Volume to Capacity	0.00	0.00	0.14			
Queue Length 95th (ft)	0	0	0			
Control Delay (s)	0.0	0.0	0.0			
Lane LOS	A					
Approach Delay (s)	0.0	0.0	0.0			
Approach LOS	A					
Intersection Summary						
Average Delay			0.0			
Intersection Capacity Utilization			26.3%	ICU Level of Service		A
Analysis Period (min)			15			

2016 BackgroundTraffic PM Peak Hour
6: Villa Rd & Fulton St

												
Movement	EBL	EBT	EBR	WBL	WBT	WBR	NBL	NBT	NBR	SBL	SBT	SBR
Lane Configurations												
Volume (veh/h)	130	0	82	3	0	1	93	195	7	0	157	171
Sign Control		Stop			Stop			Free			Free	
Grade		0%			0%			0%			0%	
Peak Hour Factor	0.84	0.84	0.84	0.84	0.84	0.84	0.84	0.84	0.84	0.84	0.84	0.84
Hourly flow rate (vph)	155	0	98	4	0	1	111	232	8	0	187	204
Pedestrians		15			3			2			3	
Lane Width (ft)		12.0			12.0			12.0			12.0	
Walking Speed (ft/s)		4.0			4.0			4.0			4.0	
Percent Blockage		1			0			0			0	
Right turn flare (veh)			6									
Median type								None			None	
Median storage (veh)												
Upstream signal (ft)												
pX, platoon unblocked												
vC, conflicting volume	766	769	306	800	866	242	405			243		
vC1, stage 1 conf vol												
vC2, stage 2 conf vol												
vCu, unblocked vol	766	769	306	800	866	242	405			243		
tC, single (s)	7.1	6.5	6.2	7.1	6.5	6.2	4.1			4.1		
tC, 2 stage (s)												
tF (s)	3.5	4.0	3.3	3.5	4.0	3.3	2.2			2.2		
p0 queue free %	46	100	87	99	100	100	90			100		
cM capacity (veh/h)	289	297	724	241	261	797	1150			1331		
Direction, Lane #	EB 1	WB 1	NB 1	SB 1								
Volume Total	252	5	351	390								
Volume Left	155	4	111	0								
Volume Right	98	1	8	204								
cSH	471	292	1150	1331								
Volume to Capacity	0.54	0.02	0.10	0.00								
Queue Length 95th (ft)	78	1	8	0								
Control Delay (s)	23.1	17.5	3.3	0.0								
Lane LOS	C	C	A									
Approach Delay (s)	23.1	17.5	3.3	0.0								
Approach LOS	C	C										
Intersection Summary												
Average Delay			7.1									
Intersection Capacity Utilization			54.5%		ICU Level of Service					A		
Analysis Period (min)			15									

2016 BackgroundTraffic PM Peak Hour
7: Villa Rd & Hwy 99W

												
Movement	EBL	EBT	EBR	WBL	WBT	WBR	NBL	NBT	NBR	SBL	SBT	SBR
Lane Configurations		 			 		 					
Volume (vph)	71	1370	6	20	1638	93	714	116	18	155	68	111
Ideal Flow (vphpl)	1900	1900	1900	1900	1900	1900	1900	1900	1900	1900	1900	1900
Total Lost time (s)	4.5	4.5		4.5	4.5		4.5	5.0		4.5	5.0	5.0
Lane Util. Factor	1.00	0.95		1.00	0.91		0.97	1.00		1.00	1.00	1.00
Frbp, ped/bikes	1.00	1.00		1.00	1.00		1.00	1.00		1.00	1.00	1.00
Flpb, ped/bikes	1.00	1.00		1.00	1.00		1.00	1.00		1.00	1.00	1.00
Frt	1.00	1.00		1.00	0.99		1.00	0.98		1.00	1.00	0.85
Flt Protected	0.95	1.00		0.95	1.00		0.95	1.00		0.95	1.00	1.00
Satd. Flow (prot)	1805	3469		1805	4995		3335	1812		1805	1900	1583
Flt Permitted	0.95	1.00		0.95	1.00		0.95	1.00		0.95	1.00	1.00
Satd. Flow (perm)	1805	3469		1805	4995		3335	1812		1805	1900	1583
Peak-hour factor, PHF	0.95	0.95	0.95	0.95	0.95	0.95	0.95	0.95	0.95	0.95	0.95	0.95
Adj. Flow (vph)	75	1442	6	21	1724	98	752	122	19	163	72	117
RTOR Reduction (vph)	0	0	0	0	3	0	0	8	0	0	0	105
Lane Group Flow (vph)	75	1448	0	21	1819	0	752	133	0	163	72	12
Confl. Peds. (#/hr)	1		2	2		1			2	2		
Heavy Vehicles (%)	0%	4%	0%	0%	3%	1%	5%	2%	6%	0%	0%	2%
Turn Type	Prot	NA		Prot	NA		Prot	NA		Prot	NA	Perm
Protected Phases	7	4		3	8		5	2		1	6	
Permitted Phases												6
Actuated Green, G (s)	8.7	75.1		3.1	69.5		10.5	12.8		10.5	12.8	12.8
Effective Green, g (s)	8.7	75.1		3.1	69.5		10.5	12.8		10.5	12.8	12.8
Actuated g/C Ratio	0.07	0.63		0.03	0.58		0.09	0.11		0.09	0.11	0.11
Clearance Time (s)	4.5	4.5		4.5	4.5		4.5	5.0		4.5	5.0	5.0
Vehicle Extension (s)	2.5	2.5		2.5	2.5		2.5	4.2		2.5	4.2	4.2
Lane Grp Cap (vph)	130	2171		46	2892		291	193		157	202	168
v/s Ratio Prot	c0.04	c0.42		0.01	0.36		c0.23	c0.07		0.09	0.04	
v/s Ratio Perm												0.01
v/c Ratio	0.58	0.67		0.46	0.63		2.58	0.69		1.04	0.36	0.07
Uniform Delay, d1	53.9	14.4		57.6	16.7		54.8	51.7		54.8	49.8	48.3
Progression Factor	1.00	1.00		1.00	1.00		1.00	1.00		1.00	1.00	1.00
Incremental Delay, d2	5.0	0.7		5.2	0.4		722.8	18.3		82.3	4.9	0.9
Delay (s)	58.9	15.1		62.8	17.1		777.6	69.9		137.0	54.6	49.1
Level of Service	E	B		E	B		F	E		F	D	D
Approach Delay (s)		17.3			17.6			665.9			91.0	
Approach LOS		B			B			F			F	
Intersection Summary												
HCM 2000 Control Delay			148.6			HCM 2000 Level of Service			F			
HCM 2000 Volume to Capacity ratio			0.88									
Actuated Cycle Length (s)			120.0			Sum of lost time (s)		18.5				
Intersection Capacity Utilization			91.2%			ICU Level of Service		F				
Analysis Period (min)			15									
c Critical Lane Group												

2016 BackgroundTraffic PM Peak Hour
7: Villa Rd & Hwy 99W

Movement	EBL	EBT	EBR	WBL	WBT	WBR	NBL	NBT	NBR	SBL	SBT	SBR
Lane Configurations												
Volume (veh/h)	71	1370	6	20	1638	93	714	116	18	155	68	111
Number	7	4	14	3	8	18	5	2	12	1	6	16
Initial Q (Qb), veh	0	0	0	0	0	0	0	0	0	0	0	0
Ped-Bike Adj(A_pbT)	1.00		1.00	1.00		1.00	1.00		1.00	1.00		1.00
Parking Bus, Adj	1.00	1.00	1.00	1.00	1.00	1.00	1.00	1.00	1.00	1.00	1.00	1.00
Adj Sat Flow, veh/h/ln	1900	1827	1900	1900	1847	1900	1810	1853	1900	1900	1900	1863
Adj Flow Rate, veh/h	75	1442	6	21	1724	98	752	122	19	163	72	117
Adj No. of Lanes	1	2	0	1	3	0	2	1	0	1	1	1
Peak Hour Factor	0.95	0.95	0.95	0.95	0.95	0.95	0.95	0.95	0.95	0.95	0.95	0.95
Percent Heavy Veh, %	0	4	4	0	3	3	5	2	2	0	0	2
Cap, veh/h	96	952	4	43	1168	66	247	788	123	134	957	796
Arrive On Green	0.05	0.27	0.27	0.02	0.24	0.24	0.07	0.50	0.50	0.07	0.50	0.50
Sat Flow, veh/h	1810	3546	15	1810	4880	277	3343	1566	244	1810	1900	1581
Grp Volume(v), veh/h	75	706	742	21	1187	635	752	0	141	163	72	117
Grp Sat Flow(s),veh/h/ln	1810	1736	1825	1810	1680	1796	1672	0	1810	1810	1900	1581
Q Serve(g_s), s	5.8	38.1	38.1	1.6	34.0	34.0	10.5	0.0	6.0	10.5	2.8	5.6
Cycle Q Clear(g_c), s	5.8	38.1	38.1	1.6	34.0	34.0	10.5	0.0	6.0	10.5	2.8	5.6
Prop In Lane	1.00		0.01	1.00		0.15	1.00		0.13	1.00		1.00
Lane Grp Cap(c), veh/h	96	466	490	43	805	430	247	0	911	134	957	796
V/C Ratio(X)	0.78	1.51	1.52	0.49	1.47	1.48	3.04	0.00	0.15	1.22	0.08	0.15
Avail Cap(c_a), veh/h	299	466	490	299	805	430	247	0	911	134	957	796
HCM Platoon Ratio	1.00	1.00	1.00	1.00	1.00	1.00	1.00	1.00	1.00	1.00	1.00	1.00
Upstream Filter(l)	1.00	1.00	1.00	1.00	1.00	1.00	1.00	0.00	1.00	1.00	1.00	1.00
Uniform Delay (d), s/veh	66.5	51.9	51.9	68.5	54.0	54.0	65.8	0.0	19.0	65.8	18.2	18.9
Incr Delay (d2), s/veh	10.0	242.5	242.2	6.2	220.3	227.0	929.6	0.0	0.4	148.0	0.2	0.4
Initial Q Delay(d3),s/veh	0.0	0.0	0.0	0.0	0.0	0.0	0.0	0.0	0.0	0.0	0.0	0.0
%ile BackOfQ(50%),veh/ln	3.2	49.6	52.1	0.9	40.4	44.0	36.8	0.0	3.1	10.7	1.5	2.5
LnGrp Delay(d),s/veh	76.4	294.4	294.2	74.7	274.3	281.0	995.3	0.0	19.3	213.8	18.3	19.3
LnGrp LOS	E	F	F	E	F	F	F		B	F	B	B
Approach Vol, veh/h		1523			1843			893				352
Approach Delay, s/veh		283.6			274.4			841.2				109.2
Approach LOS		F			F			F				F
Timer	1	2	3	4	5	6	7	8				
Assigned Phs	1	2	3	4	5	6	7	8				
Phs Duration (G+Y+Rc), s	15.0	76.5	7.9	42.6	15.0	76.5	12.0	38.5				
Change Period (Y+Rc), s	4.5	5.0	4.5	4.5	4.5	5.0	4.5	4.5				
Max Green Setting (Gmax), s	10.5	55.0	23.5	31.0	10.5	55.0	23.5	34.0				
Max Q Clear Time (g_c+I1), s	12.5	8.0	3.6	40.1	12.5	7.6	7.8	36.0				
Green Ext Time (p_c), s	0.0	2.8	0.0	0.0	0.0	2.8	0.1	0.0				
Intersection Summary												
HCM 2010 Ctrl Delay			374.6									
HCM 2010 LOS			F									

Appendix F Year 2016 Total Traffic Level-of-
Service Worksheets

2016 Total Traffic AM Peak Hour
1: Aldersgate Ln & E Crestview Dr











	→	↘	↙	←	↖	↗
Movement	EBT	EBR	WBL	WBT	NBL	NBR
Lane Configurations	↖			↖	↖	
Volume (veh/h)	166	3	2	92	6	5
Sign Control	Free			Free	Stop	
Grade	0%			0%	0%	
Peak Hour Factor	0.63	0.63	0.63	0.63	0.63	0.63
Hourly flow rate (vph)	263	5	3	146	10	8
Pedestrians	4				3	
Lane Width (ft)	12.0				12.0	
Walking Speed (ft/s)	4.0				4.0	
Percent Blockage	0				0	
Right turn flare (veh)						
Median type	None			None		
Median storage (veh)						
Upstream signal (ft)						
pX, platoon unblocked						
vC, conflicting volume			271		425	269
vC1, stage 1 conf vol						
vC2, stage 2 conf vol						
vCu, unblocked vol			271		425	269
tC, single (s)			4.1		6.4	6.2
tC, 2 stage (s)						
tF (s)			2.2		3.5	3.3
p0 queue free %			100		98	99
cM capacity (veh/h)			1301		585	773
Direction, Lane #	EB 1	WB 1	NB 1			
Volume Total	268	149	17			
Volume Left	0	3	10			
Volume Right	5	0	8			
cSH	1700	1301	657			
Volume to Capacity	0.16	0.00	0.03			
Queue Length 95th (ft)	0	0	2			
Control Delay (s)	0.0	0.2	10.6			
Lane LOS		A	B			
Approach Delay (s)	0.0	0.2	10.6			
Approach LOS			B			
Intersection Summary						
Average Delay			0.5			
Intersection Capacity Utilization			19.3%	ICU Level of Service		A
Analysis Period (min)			15			

2016 Total Traffic AM Peak Hour
2: Aldersgate Ln & Park Ln



Movement	WBL	WBR	NBT	NBR	SBL	SBT
Lane Configurations	Y		T			T
Volume (veh/h)	14	3	5	36	6	2
Sign Control	Stop		Free			Free
Grade	0%		0%			0%
Peak Hour Factor	0.77	0.77	0.77	0.77	0.77	0.77
Hourly flow rate (vph)	18	4	6	47	8	3
Pedestrians	1					
Lane Width (ft)	12.0					
Walking Speed (ft/s)	4.0					
Percent Blockage	0					
Right turn flare (veh)						
Median type			None			None
Median storage (veh)						
Upstream signal (ft)						
pX, platoon unblocked						
vC, conflicting volume	49	31			54	
vC1, stage 1 conf vol						
vC2, stage 2 conf vol						
vCu, unblocked vol	49	31			54	
tC, single (s)	6.4	6.2			4.1	
tC, 2 stage (s)						
tF (s)	3.5	3.3			2.2	
p0 queue free %	98	100			100	
cM capacity (veh/h)	960	1048			1563	
Direction, Lane #	WB 1	NB 1	SB 1			
Volume Total	22	53	10			
Volume Left	18	0	8			
Volume Right	4	47	0			
cSH	974	1700	1563			
Volume to Capacity	0.02	0.03	0.00			
Queue Length 95th (ft)	2	0	0			
Control Delay (s)	8.8	0.0	5.5			
Lane LOS	A		A			
Approach Delay (s)	8.8	0.0	5.5			
Approach LOS	A					
Intersection Summary						
Average Delay			2.9			
Intersection Capacity Utilization			15.3%	ICU Level of Service		A
Analysis Period (min)			15			

2016 Total Traffic AM Peak Hour
4: Villa Rd & Park Ln

						
Movement	EBL	EBR	NBL	NBT	SBT	SBR
Lane Configurations						
Volume (veh/h)	4	43	10	158	287	1
Sign Control	Stop			Free	Free	
Grade	0%			0%	0%	
Peak Hour Factor	0.69	0.69	0.69	0.69	0.69	0.69
Hourly flow rate (vph)	6	62	14	229	416	1
Pedestrians				1	2	
Lane Width (ft)				12.0	12.0	
Walking Speed (ft/s)				4.0	4.0	
Percent Blockage				0	0	
Right turn flare (veh)						
Median type				None	None	
Median storage (veh)						
Upstream signal (ft)						
pX, platoon unblocked						
vC, conflicting volume	677	418	417			
vC1, stage 1 conf vol						
vC2, stage 2 conf vol						
vCu, unblocked vol	677	418	417			
tC, single (s)	6.4	6.2	4.1			
tC, 2 stage (s)						
tF (s)	3.5	3.3	2.2			
p0 queue free %	99	90	99			
cM capacity (veh/h)	416	639	1153			
Direction, Lane #	EB 1	EB 2	NB 1	SB 1		
Volume Total	6	62	243	417		
Volume Left	6	0	14	0		
Volume Right	0	62	0	1		
cSH	416	639	1153	1700		
Volume to Capacity	0.01	0.10	0.01	0.25		
Queue Length 95th (ft)	1	8	1	0		
Control Delay (s)	13.8	11.2	0.6	0.0		
Lane LOS	B	B	A			
Approach Delay (s)	11.5		0.6	0.0		
Approach LOS	B					
Intersection Summary						
Average Delay			1.3			
Intersection Capacity Utilization			26.8%	ICU Level of Service		A
Analysis Period (min)			15			

2016 Total Traffic AM Peak Hour
5: Villa Rd & Site Access

Movement	EBL	EBR	NBL	NBT	SBT	SBR
Lane Configurations						
Volume (veh/h)	2	40	10	166	330	0
Sign Control	Stop			Free	Free	
Grade	0%			0%	0%	
Peak Hour Factor	0.69	0.69	0.69	0.69	0.69	0.69
Hourly flow rate (vph)	3	58	14	241	478	0
Pedestrians				1	2	
Lane Width (ft)				12.0	12.0	
Walking Speed (ft/s)				4.0	4.0	
Percent Blockage				0	0	
Right turn flare (veh)						
Median type				None	None	
Median storage (veh)						
Upstream signal (ft)						
pX, platoon unblocked						
vC, conflicting volume	750	479	478			
vC1, stage 1 conf vol						
vC2, stage 2 conf vol						
vCu, unblocked vol	750	479	478			
tC, single (s)	6.4	6.2	4.1			
tC, 2 stage (s)						
tF (s)	3.5	3.3	2.2			
p0 queue free %	99	90	99			
cM capacity (veh/h)	376	590	1095			
Direction, Lane #	EB 1	NB 1	SB 1			
Volume Total	61	255	478			
Volume Left	3	14	0			
Volume Right	58	0	0			
cSH	574	1095	1700			
Volume to Capacity	0.11	0.01	0.28			
Queue Length 95th (ft)	9	1	0			
Control Delay (s)	12.0	0.6	0.0			
Lane LOS	B	A				
Approach Delay (s)	12.0	0.6	0.0			
Approach LOS	B					
Intersection Summary						
Average Delay			1.1			
Intersection Capacity Utilization		27.7%		ICU Level of Service		A
Analysis Period (min)			15			

2016 Total Traffic AM Peak Hour
6: Villa Rd & Fulton St

Movement	EBL	EBT	EBR	WBL	WBT	WBR	NBL	NBT	NBR	SBL	SBT	SBR	
Lane Configurations													
Volume (veh/h)	137	1	65	2	1	1	75	112	5	5	231	79	
Sign Control		Stop			Stop			Free			Free		
Grade		0%			0%			0%			0%		
Peak Hour Factor	0.84	0.84	0.84	0.84	0.84	0.84	0.84	0.84	0.84	0.84	0.84	0.84	
Hourly flow rate (vph)	163	1	77	2	1	1	89	133	6	6	275	94	
Pedestrians		15			3			2			3		
Lane Width (ft)		12.0			12.0			12.0			12.0		
Walking Speed (ft/s)		4.0			4.0			4.0			4.0		
Percent Blockage		1			0			0			0		
Right turn flare (veh)			6										
Median type								None			None		
Median storage (veh)													
Upstream signal (ft)													
pX, platoon unblocked													
vC, conflicting volume	669	670	339	693	714	142	384			142			
vC1, stage 1 conf vol													
vC2, stage 2 conf vol													
vCu, unblocked vol	669	670	339	693	714	142	384			142			
tC, single (s)	7.1	6.5	6.2	7.1	6.5	6.2	4.1			4.1			
tC, 2 stage (s)													
tF (s)	3.5	4.0	3.3	3.5	4.0	3.3	2.2			2.2			
p0 queue free %	52	100	89	99	100	100	92			100			
cM capacity (veh/h)	339	345	693	295	326	906	1171			1449			
Direction, Lane #	EB 1	WB 1	NB 1	SB 1									
Volume Total	242	5	229	375									
Volume Left	163	2	89	6									
Volume Right	77	1	6	94									
cSH	499	365	1171	1449									
Volume to Capacity	0.48	0.01	0.08	0.00									
Queue Length 95th (ft)	65	1	6	0									
Control Delay (s)	20.6	15.0	3.7	0.2									
Lane LOS	C	B	A	A									
Approach Delay (s)	20.6	15.0	3.7	0.2									
Approach LOS	C	B											
Intersection Summary													
Average Delay			7.0										
Intersection Capacity Utilization			51.7%		ICU Level of Service					A			
Analysis Period (min)			15										

2016 Total Traffic AM Peak Hour
7: Villa Rd & Hwy 99W

Movement	EBL	EBT	EBR	WBL	WBT	WBR	NBL	NBT	NBR	SBL	SBT	SBR
Lane Configurations												
Volume (vph)	103	1381	2	8	956	108	391	71	10	142	72	65
Ideal Flow (vphpl)	1900	1900	1900	1900	1900	1900	1900	1900	1900	1900	1900	1900
Total Lost time (s)	4.5	4.5		4.5	4.5		4.5	5.0		4.5	5.0	5.0
Lane Util. Factor	1.00	0.95		1.00	0.91		0.97	1.00		1.00	1.00	1.00
Frbp, ped/bikes	1.00	1.00		1.00	1.00		1.00	1.00		1.00	1.00	1.00
Flpb, ped/bikes	1.00	1.00		1.00	1.00		1.00	1.00		1.00	1.00	1.00
Frt	1.00	1.00		1.00	0.98		1.00	0.98		1.00	1.00	0.85
Flt Protected	0.95	1.00		0.95	1.00		0.95	1.00		0.95	1.00	1.00
Satd. Flow (prot)	1805	3438		1805	4634		2968	1670		1752	1900	1583
Flt Permitted	0.95	1.00		0.95	1.00		0.95	1.00		0.95	1.00	1.00
Satd. Flow (perm)	1805	3438		1805	4634		2968	1670		1752	1900	1583
Peak-hour factor, PHF	0.90	0.90	0.90	0.90	0.90	0.90	0.90	0.90	0.90	0.90	0.90	0.90
Adj. Flow (vph)	114	1534	2	9	1062	120	434	79	11	158	80	72
RTOR Reduction (vph)	0	0	0	0	8	0	0	8	0	0	0	66
Lane Group Flow (vph)	114	1536	0	9	1174	0	434	82	0	158	80	6
Confl. Peds. (#/hr)	1		2	2		1			2	2		
Heavy Vehicles (%)	0%	5%	0%	0%	11%	1%	18%	10%	22%	3%	0%	2%
Turn Type	Prot	NA		Prot	NA		Prot	NA		Prot	NA	Perm
Protected Phases	7	4		3	8		5	2		1	6	
Permitted Phases												6
Actuated Green, G (s)	11.1	61.6		1.3	51.8		10.7	10.9		7.7	7.9	7.9
Effective Green, g (s)	11.1	61.6		1.3	51.8		10.7	10.9		7.7	7.9	7.9
Actuated g/C Ratio	0.11	0.62		0.01	0.52		0.11	0.11		0.08	0.08	0.08
Clearance Time (s)	4.5	4.5		4.5	4.5		4.5	5.0		4.5	5.0	5.0
Vehicle Extension (s)	2.5	2.5		2.5	2.5		2.5	4.2		2.5	4.2	4.2
Lane Grp Cap (vph)	200	2117		23	2400		317	182		134	150	125
v/s Ratio Prot	c0.06	c0.45		0.00	0.25		c0.15	c0.05		0.09	0.04	
v/s Ratio Perm												0.00
v/c Ratio	0.57	0.73		0.39	0.49		1.37	0.45		1.18	0.53	0.05
Uniform Delay, d1	42.2	13.3		49.0	15.6		44.6	41.7		46.1	44.3	42.6
Progression Factor	1.00	1.00		1.00	1.00		1.00	1.00		1.00	1.00	1.00
Incremental Delay, d2	3.0	1.2		7.8	0.1		185.0	7.9		133.8	12.9	0.7
Delay (s)	45.2	14.5		56.8	15.7		229.6	49.6		180.0	57.2	43.3
Level of Service	D	B		E	B		F	D		F	E	D
Approach Delay (s)		16.6			16.0			198.7			116.5	
Approach LOS		B			B			F			F	
Intersection Summary												
HCM 2000 Control Delay			50.8				HCM 2000 Level of Service				D	
HCM 2000 Volume to Capacity ratio			0.79									
Actuated Cycle Length (s)			100.0				Sum of lost time (s)			18.5		
Intersection Capacity Utilization			79.1%				ICU Level of Service			D		
Analysis Period (min)			15									
c Critical Lane Group												

2016 Total Traffic AM Peak Hour
7: Villa Rd & Hwy 99W

Movement	EBL	EBT	EBR	WBL	WBT	WBR	NBL	NBT	NBR	SBL	SBT	SBR
Lane Configurations												
Volume (veh/h)	103	1381	2	8	956	108	391	71	10	142	72	65
Number	7	4	14	3	8	18	5	2	12	1	6	16
Initial Q (Qb), veh	0	0	0	0	0	0	0	0	0	0	0	0
Ped-Bike Adj(A_pbT)	1.00		1.00	1.00		1.00	1.00		1.00	1.00		1.00
Parking Bus, Adj	1.00	1.00	1.00	1.00	1.00	1.00	1.00	1.00	1.00	1.00	1.00	1.00
Adj Sat Flow, veh/h/ln	1900	1810	1900	1900	1728	1900	1610	1705	1900	1845	1900	1863
Adj Flow Rate, veh/h	114	1534	2	9	1062	120	434	79	11	158	80	72
Adj No. of Lanes	1	2	0	1	3	0	2	1	0	1	1	1
Peak Hour Factor	0.90	0.90	0.90	0.90	0.90	0.90	0.90	0.90	0.90	0.90	0.90	0.90
Percent Heavy Veh, %	0	5	5	0	11	11	18	10	10	3	0	2
Cap, veh/h	141	1170	2	23	1149	130	260	642	89	110	785	653
Arrive On Green	0.08	0.33	0.33	0.01	0.27	0.27	0.09	0.44	0.44	0.06	0.41	0.41
Sat Flow, veh/h	1810	3523	5	1810	4299	485	2975	1464	204	1757	1900	1581
Grp Volume(v), veh/h	114	748	788	9	776	406	434	0	90	158	80	72
Grp Sat Flow(s),veh/h/ln	1810	1719	1809	1810	1572	1640	1487	0	1668	1757	1900	1581
Q Serve(g_s), s	7.4	39.9	39.9	0.6	28.8	28.9	10.5	0.0	3.8	7.5	3.1	3.4
Cycle Q Clear(g_c), s	7.4	39.9	39.9	0.6	28.8	28.9	10.5	0.0	3.8	7.5	3.1	3.4
Prop In Lane	1.00		0.00	1.00		0.30	1.00		0.12	1.00		1.00
Lane Grp Cap(c), veh/h	141	571	601	23	840	438	260	0	731	110	785	653
V/C Ratio(X)	0.81	1.31	1.31	0.38	0.92	0.93	1.67	0.00	0.12	1.44	0.10	0.11
Avail Cap(c_a), veh/h	279	571	601	279	891	465	260	0	731	110	785	653
HCM Platoon Ratio	1.00	1.00	1.00	1.00	1.00	1.00	1.00	1.00	1.00	1.00	1.00	1.00
Upstream Filter(I)	1.00	1.00	1.00	1.00	1.00	1.00	1.00	0.00	1.00	1.00	1.00	1.00
Uniform Delay (d), s/veh	54.4	40.1	40.1	58.7	42.8	42.8	54.8	0.0	20.0	56.3	21.6	21.6
Incr Delay (d2), s/veh	7.9	152.0	151.5	7.5	14.4	23.6	316.6	0.0	0.3	241.5	0.3	0.3
Initial Q Delay(d3),s/veh	0.0	0.0	0.0	0.0	0.0	0.0	0.0	0.0	0.0	0.0	0.0	0.0
%ile BackOfQ(50%),veh/ln	4.0	43.0	45.1	0.3	14.2	15.9	15.8	0.0	1.8	11.0	1.7	1.5
LnGrp Delay(d),s/veh	62.4	192.1	191.6	66.2	57.1	66.4	371.4	0.0	20.4	297.7	21.8	22.0
LnGrp LOS	E	F	F	E	E	E	F		C	F	C	C
Approach Vol, veh/h		1650			1191			524				310
Approach Delay, s/veh		182.9			60.4			311.1				162.5
Approach LOS		F			E			F				F
Timer	1	2	3	4	5	6	7	8				
Assigned Phs	1	2	3	4	5	6	7	8				
Phs Duration (G+Y+Rc), s	12.0	57.6	6.1	44.4	15.0	54.6	13.8	36.6				
Change Period (Y+Rc), s	4.5	5.0	4.5	4.5	4.5	5.0	4.5	4.5				
Max Green Setting (Gmax), s	7.5	42.0	18.5	31.0	10.5	39.0	18.5	34.0				
Max Q Clear Time (g_c+I1), s	9.5	5.8	2.6	41.9	12.5	5.4	9.4	30.9				
Green Ext Time (p_c), s	0.0	2.0	0.0	0.0	0.0	1.9	0.1	1.2				
Intersection Summary												
HCM 2010 Ctrl Delay			159.7									
HCM 2010 LOS			F									











2016 Total Traffic PM Peak Hour
1: Aldersgate Ln & E Crestview Dr

	→	↘	↙	←	↖	↗
Movement	EBT	EBR	WBL	WBT	NBL	NBR
Lane Configurations	↖			↖	↖	
Volume (veh/h)	63	8	3	127	4	2
Sign Control	Free			Free	Stop	
Grade	0%			0%	0%	
Peak Hour Factor	0.83	0.83	0.83	0.83	0.83	0.83
Hourly flow rate (vph)	76	10	4	153	5	2
Pedestrians	4			1	4	
Lane Width (ft)	12.0			12.0	12.0	
Walking Speed (ft/s)	4.0			4.0	4.0	
Percent Blockage	0			0	0	
Right turn flare (veh)						
Median type	None			None		
Median storage (veh)						
Upstream signal (ft)						
pX, platoon unblocked						
vC, conflicting volume			90		249	86
vC1, stage 1 conf vol						
vC2, stage 2 conf vol						
vCu, unblocked vol			90		249	86
tC, single (s)			4.1		6.4	6.2
tC, 2 stage (s)						
tF (s)			2.2		3.5	3.3
p0 queue free %			100		99	100
cM capacity (veh/h)			1513		737	975
Direction, Lane #	EB 1	WB 1	NB 1			
Volume Total	86	157	7			
Volume Left	0	4	5			
Volume Right	10	0	2			
cSH	1700	1513	802			
Volume to Capacity	0.05	0.00	0.01			
Queue Length 95th (ft)	0	0	1			
Control Delay (s)	0.0	0.2	9.5			
Lane LOS		A	A			
Approach Delay (s)	0.0	0.2	9.5			
Approach LOS			A			
Intersection Summary						
Average Delay			0.4			
Intersection Capacity Utilization			19.4%	ICU Level of Service		A
Analysis Period (min)			15			









2016 Total Traffic PM Peak Hour
2: Aldersgate Ln & Park Ln

	↙	↘	↑	↗	↘	↓
Movement	WBL	WBR	NBT	NBR	SBL	SBT
Lane Configurations	↙		↗			↘
Volume (veh/h)	60	10	2	26	11	1
Sign Control	Stop		Free			Free
Grade	0%		0%			0%
Peak Hour Factor	0.71	0.71	0.71	0.71	0.71	0.71
Hourly flow rate (vph)	85	14	3	37	15	1
Pedestrians	1		1			
Lane Width (ft)	12.0		12.0			
Walking Speed (ft/s)	4.0		4.0			
Percent Blockage	0		0			
Right turn flare (veh)						
Median type			None			None
Median storage (veh)						
Upstream signal (ft)						
pX, platoon unblocked						
vC, conflicting volume	56	22			40	
vC1, stage 1 conf vol						
vC2, stage 2 conf vol						
vCu, unblocked vol	56	22			40	
tC, single (s)	6.4	6.3			4.1	
tC, 2 stage (s)						
tF (s)	3.5	3.4			2.2	
p0 queue free %	91	99			99	
cM capacity (veh/h)	941	1020			1581	
Direction, Lane #	WB 1	NB 1	SB 1			
Volume Total	99	39	17			
Volume Left	85	0	15			
Volume Right	14	37	0			
cSH	952	1700	1581			
Volume to Capacity	0.10	0.02	0.01			
Queue Length 95th (ft)	9	0	1			
Control Delay (s)	9.2	0.0	6.7			
Lane LOS	A		A			
Approach Delay (s)	9.2	0.0	6.7			
Approach LOS	A					
Intersection Summary						
Average Delay			6.6			
Intersection Capacity Utilization			17.9%	ICU Level of Service		A
Analysis Period (min)			15			

















2016 Total Traffic PM Peak Hour
4: Villa Rd & Park Ln

						
Movement	EBL	EBR	NBL	NBT	SBT	SBR
Lane Configurations						
Volume (veh/h)	3	29	59	246	176	9
Sign Control	Stop			Free	Free	
Grade	0%			0%	0%	
Peak Hour Factor	0.85	0.85	0.85	0.85	0.85	0.85
Hourly flow rate (vph)	4	34	69	289	207	11
Pedestrians					1	
Lane Width (ft)					12.0	
Walking Speed (ft/s)					4.0	
Percent Blockage					0	
Right turn flare (veh)						
Median type				None	None	
Median storage (veh)						
Upstream signal (ft)						
pX, platoon unblocked						
vC, conflicting volume	642	212	218			
vC1, stage 1 conf vol						
vC2, stage 2 conf vol						
vCu, unblocked vol	642	212	218			
tC, single (s)	6.4	6.2	4.1			
tC, 2 stage (s)						
tF (s)	3.5	3.3	2.2			
p0 queue free %	99	96	95			
cM capacity (veh/h)	419	833	1364			
Direction, Lane #	EB 1	EB 2	NB 1	SB 1		
Volume Total	4	34	359	218		
Volume Left	4	0	69	0		
Volume Right	0	34	0	11		
cSH	419	833	1364	1700		
Volume to Capacity	0.01	0.04	0.05	0.13		
Queue Length 95th (ft)	1	3	4	0		
Control Delay (s)	13.7	9.5	1.9	0.0		
Lane LOS	B	A	A			
Approach Delay (s)	9.9		1.9	0.0		
Approach LOS	A					
Intersection Summary						
Average Delay			1.7			
Intersection Capacity Utilization			39.4%	ICU Level of Service		A
Analysis Period (min)			15			





















2016 Total Traffic PM Peak Hour
5: Villa Rd & Haworth

						
Movement	EBL	EBR	NBL	NBT	SBT	SBR
Lane Configurations						
Volume (veh/h)	1	23	43	304	203	3
Sign Control	Stop			Free	Free	
Grade	0%			0%	0%	
Peak Hour Factor	0.69	0.69	0.69	0.69	0.69	0.69
Hourly flow rate (vph)	1	33	62	441	294	4
Pedestrians				1	2	
Lane Width (ft)				12.0	12.0	
Walking Speed (ft/s)				4.0	4.0	
Percent Blockage				0	0	
Right turn flare (veh)						
Median type				None	None	
Median storage (veh)						
Upstream signal (ft)						
pX, platoon unblocked						
vC, conflicting volume	864	297	299			
vC1, stage 1 conf vol						
vC2, stage 2 conf vol						
vCu, unblocked vol	864	297	299			
tC, single (s)	6.4	6.2	4.1			
tC, 2 stage (s)						
tF (s)	3.5	3.3	2.2			
p0 queue free %	100	96	95			
cM capacity (veh/h)	311	746	1274			
Direction, Lane #	EB 1	NB 1	SB 1			
Volume Total	35	503	299			
Volume Left	1	62	0			
Volume Right	33	0	4			
cSH	705	1274	1700			
Volume to Capacity	0.05	0.05	0.18			
Queue Length 95th (ft)	4	4	0			
Control Delay (s)	10.4	1.4	0.0			
Lane LOS	B	A				
Approach Delay (s)	10.4	1.4	0.0			
Approach LOS	B					
Intersection Summary						
Average Delay			1.3			
Intersection Capacity Utilization		42.9%		ICU Level of Service		A
Analysis Period (min)			15			

2016 Total Traffic PM Peak Hour
6: Villa Rd & Fulton St

												
Movement	EBL	EBT	EBR	WBL	WBT	WBR	NBL	NBT	NBR	SBL	SBT	SBR
Lane Configurations												
Volume (veh/h)	130	0	82	3	0	1	93	238	7	0	180	171
Sign Control		Stop			Stop			Free			Free	
Grade		0%			0%			0%			0%	
Peak Hour Factor	0.87	0.87	0.87	0.87	0.87	0.87	0.87	0.87	0.87	0.87	0.87	0.87
Hourly flow rate (vph)	149	0	94	3	0	1	107	274	8	0	207	197
Pedestrians		13			1			1			8	
Lane Width (ft)		12.0			12.0			12.0			12.0	
Walking Speed (ft/s)		4.0			4.0			4.0			4.0	
Percent Blockage		1			0			0			1	
Right turn flare (veh)			6									
Median type								None			None	
Median storage (veh)												
Upstream signal (ft)												
pX, platoon unblocked												
vC, conflicting volume	819	815	319	846	909	287	416			283		
vC1, stage 1 conf vol												
vC2, stage 2 conf vol												
vCu, unblocked vol	819	815	319	846	909	287	416			283		
tC, single (s)	7.1	6.5	6.2	7.1	6.5	6.2	4.1			4.1		
tC, 2 stage (s)												
tF (s)	3.5	4.0	3.3	3.5	4.0	3.3	2.2			2.2		
p0 queue free %	44	100	87	98	100	100	91			100		
cM capacity (veh/h)	267	281	715	227	248	752	1130			1290		
Direction, Lane #	EB 1	WB 1	NB 1	SB 1								
Volume Total	244	5	389	403								
Volume Left	149	3	107	0								
Volume Right	94	1	8	197								
cSH	435	275	1130	1290								
Volume to Capacity	0.56	0.02	0.09	0.00								
Queue Length 95th (ft)	84	1	8	0								
Control Delay (s)	25.3	18.3	3.0	0.0								
Lane LOS	D	C	A									
Approach Delay (s)	25.3	18.3	3.0	0.0								
Approach LOS	D	C										
Intersection Summary												
Average Delay			7.1									
Intersection Capacity Utilization			57.6%		ICU Level of Service					B		
Analysis Period (min)			15									

2016 Total Traffic PM Peak Hour
7: Villa Rd & Hwy 99W

												
Movement	EBL	EBT	EBR	WBL	WBT	WBR	NBL	NBT	NBR	SBL	SBT	SBR
Lane Configurations												
Volume (vph)	82	1370	6	20	1638	105	714	122	18	161	71	117
Ideal Flow (vphpl)	1900	1900	1900	1900	1900	1900	1900	1900	1900	1900	1900	1900
Total Lost time (s)	4.5	4.5		4.5	4.5		4.5	5.0		4.5	5.0	5.0
Lane Util. Factor	1.00	0.95		1.00	0.91		0.97	1.00		1.00	1.00	1.00
Frbp, ped/bikes	1.00	1.00		1.00	1.00		1.00	1.00		1.00	1.00	0.96
Flpb, ped/bikes	1.00	1.00		1.00	1.00		1.00	1.00		1.00	1.00	1.00
Frt	1.00	1.00		1.00	0.99		1.00	0.98		1.00	1.00	0.85
Flt Protected	0.95	1.00		0.95	1.00		0.95	1.00		0.95	1.00	1.00
Satd. Flow (prot)	1805	3469		1805	4989		3335	1812		1805	1900	1518
Flt Permitted	0.95	1.00		0.95	1.00		0.95	1.00		0.95	1.00	1.00
Satd. Flow (perm)	1805	3469		1805	4989		3335	1812		1805	1900	1518
Peak-hour factor, PHF	0.95	0.95	0.95	0.95	0.95	0.95	0.95	0.95	0.95	0.95	0.95	0.95
Adj. Flow (vph)	86	1442	6	21	1724	111	752	128	19	169	75	123
RTOR Reduction (vph)	0	0	0	0	3	0	0	7	0	0	0	109
Lane Group Flow (vph)	86	1448	0	21	1832	0	752	140	0	169	75	14
Confl. Peds. (#/hr)	1		15	15		1	25		6	6		25
Confl. Bikes (#/hr)						2			1			1
Heavy Vehicles (%)	0%	4%	0%	0%	3%	1%	5%	2%	6%	0%	0%	2%
Turn Type	Prot	NA		Prot	NA		Prot	NA		Prot	NA	Perm
Protected Phases	7	4		3	8		5	2		1	6	
Permitted Phases												6
Actuated Green, G (s)	9.3	74.7		3.1	68.5		10.5	13.2		10.5	13.2	13.2
Effective Green, g (s)	9.3	74.7		3.1	68.5		10.5	13.2		10.5	13.2	13.2
Actuated g/C Ratio	0.08	0.62		0.03	0.57		0.09	0.11		0.09	0.11	0.11
Clearance Time (s)	4.5	4.5		4.5	4.5		4.5	5.0		4.5	5.0	5.0
Vehicle Extension (s)	2.5	2.5		2.5	2.5		2.5	4.2		2.5	4.2	4.2
Lane Grp Cap (vph)	139	2159		46	2847		291	199		157	209	166
v/s Ratio Prot	c0.05	c0.42		0.01	0.37		c0.23	c0.08		0.09	0.04	
v/s Ratio Perm												0.01
v/c Ratio	0.62	0.67		0.46	0.64		2.58	0.70		1.08	0.36	0.08
Uniform Delay, d1	53.6	14.7		57.6	17.5		54.8	51.5		54.8	49.5	48.0
Progression Factor	1.00	1.00		1.00	1.00		1.00	1.00		1.00	1.00	1.00
Incremental Delay, d2	6.8	0.8		5.2	0.4		722.8	18.8		93.7	4.7	1.0
Delay (s)	60.5	15.4		62.8	17.9		777.6	70.3		148.4	54.2	48.9
Level of Service	E	B		E	B		F	E		F	D	D
Approach Delay (s)		18.0			18.4			661.9			95.8	
Approach LOS		B			B			F			F	

Intersection Summary

HCM 2000 Control Delay	148.6	HCM 2000 Level of Service	F
HCM 2000 Volume to Capacity ratio	0.88		
Actuated Cycle Length (s)	120.0	Sum of lost time (s)	18.5
Intersection Capacity Utilization	105.5%	ICU Level of Service	G
Analysis Period (min)	15		

c Critical Lane Group

2016 Total Traffic PM Peak Hour
7: Villa Rd & Hwy 99W

Movement	EBL	EBT	EBR	WBL	WBT	WBR	NBL	NBT	NBR	SBL	SBT	SBR
Lane Configurations												
Volume (veh/h)	82	1370	6	20	1638	105	714	122	18	161	71	117
Number	7	4	14	3	8	18	5	2	12	1	6	16
Initial Q (Qb), veh	0	0	0	0	0	0	0	0	0	0	0	0
Ped-Bike Adj(A_pbT)	1.00		0.97	1.00		0.95	1.00		0.97	1.00		0.97
Parking Bus, Adj	1.00	1.00	1.00	1.00	1.00	1.00	1.00	1.00	1.00	1.00	1.00	1.00
Adj Sat Flow, veh/h/ln	1900	1827	1900	1900	1847	1900	1810	1853	1900	1900	1900	1863
Adj Flow Rate, veh/h	86	1442	6	21	1724	111	752	128	19	169	75	123
Adj No. of Lanes	1	2	0	1	3	0	2	1	0	1	1	1
Peak Hour Factor	0.95	0.95	0.95	0.95	0.95	0.95	0.95	0.95	0.95	0.95	0.95	0.95
Percent Heavy Veh, %	0	4	4	0	3	3	5	2	2	0	0	2
Cap, veh/h	108	976	4	43	1155	74	247	780	116	134	944	765
Arrive On Green	0.06	0.28	0.28	0.02	0.24	0.24	0.07	0.50	0.50	0.07	0.50	0.50
Sat Flow, veh/h	1810	3545	15	1810	4823	310	3343	1571	233	1810	1900	1540
Grp Volume(v), veh/h	86	706	742	21	1201	634	752	0	147	169	75	123
Grp Sat Flow(s),veh/h/ln	1810	1736	1824	1810	1681	1771	1672	0	1805	1810	1900	1540
Q Serve(g_s), s	6.7	39.1	39.1	1.6	34.0	34.0	10.5	0.0	6.3	10.5	2.9	6.2
Cycle Q Clear(g_c), s	6.7	39.1	39.1	1.6	34.0	34.0	10.5	0.0	6.3	10.5	2.9	6.2
Prop In Lane	1.00		0.01	1.00		0.17	1.00		0.13	1.00		1.00
Lane Grp Cap(c), veh/h	108	478	502	43	805	424	247	0	896	134	944	765
V/C Ratio(X)	0.80	1.48	1.48	0.49	1.49	1.50	3.04	0.00	0.16	1.26	0.08	0.16
Avail Cap(c_a), veh/h	299	478	502	299	805	424	247	0	896	134	944	765
HCM Platoon Ratio	1.00	1.00	1.00	1.00	1.00	1.00	1.00	1.00	1.00	1.00	1.00	1.00
Upstream Filter(I)	1.00	1.00	1.00	1.00	1.00	1.00	1.00	0.00	1.00	1.00	1.00	1.00
Uniform Delay (d), s/veh	65.9	51.5	51.5	68.5	54.0	54.0	65.8	0.0	19.6	65.8	18.7	19.5
Incr Delay (d2), s/veh	9.5	225.7	225.5	6.2	227.9	235.2	929.6	0.0	0.4	164.8	0.2	0.5
Initial Q Delay(d3),s/veh	0.0	0.0	0.0	0.0	0.0	0.0	0.0	0.0	0.0	0.0	0.0	0.0
%ile BackOfQ(50%),veh/ln	3.6	48.7	51.1	0.9	41.2	44.3	36.8	0.0	3.2	11.4	1.6	2.7
LnGrp Delay(d),s/veh	75.4	277.2	276.9	74.7	281.9	289.2	995.3	0.0	20.0	230.5	18.9	20.0
LnGrp LOS	E	F	F	E	F	F	F		B	F	B	C
Approach Vol, veh/h		1534			1856			899				367
Approach Delay, s/veh		265.8			282.1			835.8				116.7
Approach LOS		F			F			F				F
Timer	1	2	3	4	5	6	7	8				
Assigned Phs	1	2	3	4	5	6	7	8				
Phs Duration (G+Y+Rc), s	15.0	75.5	7.9	43.6	15.0	75.5	13.0	38.5				
Change Period (Y+Rc), s	4.5	5.0	4.5	4.5	4.5	5.0	4.5	4.5				
Max Green Setting (Gmax), s	10.5	55.0	23.5	31.0	10.5	55.0	23.5	34.0				
Max Q Clear Time (g_c+I1), s	12.5	8.3	3.6	41.1	12.5	8.2	8.7	36.0				
Green Ext Time (p_c), s	0.0	2.9	0.0	0.0	0.0	2.9	0.1	0.0				
Intersection Summary												
HCM 2010 Ctrl Delay			370.6									
HCM 2010 LOS			F									

Appendix G Year 2035 Background Traffic
Level-of-Service Worksheets

2035 Background Traffic PM Peak Hour
1: Aldersgate Ln & E Crestview Dr

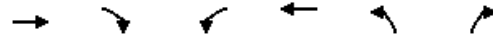

Movement	EBT	EBR	WBL	WBT	NBL	NBR
Lane Configurations	↔			↔	↔	
Volume (veh/h)	88	6	5	175	3	3
Sign Control	Free			Free	Stop	
Grade	0%			0%	0%	
Peak Hour Factor	0.83	0.83	0.83	0.83	0.83	0.83
Hourly flow rate (vph)	106	7	6	211	4	4
Pedestrians	4			1	4	
Lane Width (ft)	12.0			12.0	12.0	
Walking Speed (ft/s)	4.0			4.0	4.0	
Percent Blockage	0			0	0	
Right turn flare (veh)						
Median type	None			None		
Median storage (veh)						
Upstream signal (ft)						
pX, platoon unblocked						
vC, conflicting volume			117		341	115
vC1, stage 1 conf vol						
vC2, stage 2 conf vol						
vCu, unblocked vol			117		341	115
tC, single (s)			4.1		6.4	6.2
tC, 2 stage (s)						
tF (s)			2.2		3.5	3.3
p0 queue free %			100		99	100
cM capacity (veh/h)			1479		652	939
Direction, Lane #	EB 1	WB 1	NB 1			
Volume Total	113	217	7			
Volume Left	0	6	4			
Volume Right	7	0	4			
cSH	1700	1479	770			
Volume to Capacity	0.07	0.00	0.01			
Queue Length 95th (ft)	0	0	1			
Control Delay (s)	0.0	0.2	9.7			
Lane LOS		A	A			
Approach Delay (s)	0.0	0.2	9.7			
Approach LOS			A			
Intersection Summary						
Average Delay			0.4			
Intersection Capacity Utilization			23.6%	ICU Level of Service		A
Analysis Period (min)			15			

2035 Background Traffic PM Peak Hour
2: Aldersgate Ln & Park Ln



Movement	WBL	WBR	NBT	NBR	SBL	SBT
Lane Configurations	W		T			T
Volume (veh/h)	78	11	3	28	11	2
Sign Control	Stop		Free			Free
Grade	0%		0%			0%
Peak Hour Factor	0.71	0.71	0.71	0.71	0.71	0.71
Hourly flow rate (vph)	110	15	4	39	15	3
Pedestrians	1		1			
Lane Width (ft)	12.0		12.0			
Walking Speed (ft/s)	4.0		4.0			
Percent Blockage	0		0			
Right turn flare (veh)						
Median type			None			None
Median storage (veh)						
Upstream signal (ft)						
pX, platoon unblocked						
vC, conflicting volume	60	25			45	
vC1, stage 1 conf vol						
vC2, stage 2 conf vol						
vCu, unblocked vol	60	25			45	
tC, single (s)	6.4	6.3			4.1	
tC, 2 stage (s)						
tF (s)	3.5	3.4			2.2	
p0 queue free %	88	98			99	
cM capacity (veh/h)	936	1017			1575	
Direction, Lane #	WB 1	NB 1	SB 1			
Volume Total	125	44	18			
Volume Left	110	0	15			
Volume Right	15	39	0			
cSH	945	1700	1575			
Volume to Capacity	0.13	0.03	0.01			
Queue Length 95th (ft)	11	0	1			
Control Delay (s)	9.4	0.0	6.2			
Lane LOS	A		A			
Approach Delay (s)	9.4	0.0	6.2			
Approach LOS	A					
Intersection Summary						
Average Delay			6.9			
Intersection Capacity Utilization			19.0%	ICU Level of Service		A
Analysis Period (min)			15			

2035 Background Traffic PM Peak Hour
4: Villa Rd & Fulton St





















Movement	EBL	EBR	NBL	NBT	SBT	SBR
Lane Configurations	Y			↑	↑	
Volume (veh/h)	2	41	81	338	240	8
Sign Control	Stop			Free	Free	
Grade	0%			0%	0%	
Peak Hour Factor	0.85	0.85	0.85	0.85	0.85	0.85
Hourly flow rate (vph)	2	48	95	398	282	9
Pedestrians	13			1	8	
Lane Width (ft)	12.0			12.0	12.0	
Walking Speed (ft/s)	4.0			4.0	4.0	
Percent Blockage	1			0	1	
Right turn flare (veh)						
Median type				None	None	
Median storage (veh)						
Upstream signal (ft)						
pX, platoon unblocked						
vC, conflicting volume	896	301	305			
vC1, stage 1 conf vol						
vC2, stage 2 conf vol						
vCu, unblocked vol	896	301	305			
tC, single (s)	6.4	6.2	4.1			
tC, 2 stage (s)						
tF (s)	3.5	3.3	2.2			
p0 queue free %	99	93	92			
cM capacity (veh/h)	283	732	1242			
Direction, Lane #	EB 1	NB 1	SB 1			
Volume Total	51	493	292			
Volume Left	2	95	0			
Volume Right	48	0	9			
cSH	682	1242	1700			
Volume to Capacity	0.07	0.08	0.17			
Queue Length 95th (ft)	6	6	0			
Control Delay (s)	10.7	2.2	0.0			
Lane LOS	B	A				
Approach Delay (s)	10.7	2.2	0.0			
Approach LOS	B					
Intersection Summary						
Average Delay			2.0			
Intersection Capacity Utilization			49.1%	ICU Level of Service		A
Analysis Period (min)			15			

2035 Background Traffic PM Peak Hour
5: Villa Rd & NEW Access



























Movement	EBL	EBR	NBL	NBT	SBT	SBR
Lane Configurations						
Volume (veh/h)	0	0	0	419	281	0
Sign Control	Stop			Free	Free	
Grade	0%			0%	0%	
Peak Hour Factor	0.69	0.69	0.69	0.69	0.69	0.69
Hourly flow rate (vph)	0	0	0	607	407	0
Pedestrians				1	2	
Lane Width (ft)				12.0	12.0	
Walking Speed (ft/s)				4.0	4.0	
Percent Blockage				0	0	
Right turn flare (veh)						
Median type				None	None	
Median storage (veh)						
Upstream signal (ft)						
pX, platoon unblocked						
vC, conflicting volume	1016	408	407			
vC1, stage 1 conf vol						
vC2, stage 2 conf vol						
vCu, unblocked vol	1016	408	407			
tC, single (s)	6.4	6.2	4.1			
tC, 2 stage (s)						
tF (s)	3.5	3.3	2.2			
p0 queue free %	100	100	100			
cM capacity (veh/h)	265	647	1162			
Direction, Lane #	EB 1	NB 1	SB 1			
Volume Total	0	607	407			
Volume Left	0	0	0			
Volume Right	0	0	0			
cSH	1700	1162	1700			
Volume to Capacity	0.00	0.00	0.24			
Queue Length 95th (ft)	0	0	0			
Control Delay (s)	0.0	0.0	0.0			
Lane LOS	A					
Approach Delay (s)	0.0	0.0	0.0			
Approach LOS	A					
Intersection Summary						
Average Delay			0.0			
Intersection Capacity Utilization			32.4%	ICU Level of Service	A	
Analysis Period (min)			15			

2035 Background Traffic PM Peak Hour
6: Villa Rd & Fulton St

												
Movement	EBL	EBT	EBR	WBL	WBT	WBR	NBL	NBT	NBR	SBL	SBT	SBR
Lane Configurations												
Volume (veh/h)	220	0	165	5	0	2	175	310	0	0	145	230
Sign Control		Stop			Stop			Free			Free	
Grade		0%			0%			0%			0%	
Peak Hour Factor	0.87	0.87	0.87	0.87	0.87	0.87	0.87	0.87	0.87	0.87	0.87	0.87
Hourly flow rate (vph)	253	0	190	6	0	2	201	356	0	0	167	264
Pedestrians		13			1			1			8	
Lane Width (ft)		12.0			12.0			12.0			12.0	
Walking Speed (ft/s)		4.0			4.0			4.0			4.0	
Percent Blockage		1			0			0			1	
Right turn flare (veh)			6									
Median type								None			None	
Median storage (veh)												
Upstream signal (ft)												
pX, platoon unblocked												
vC, conflicting volume	1081	1071	313	1154	1204	365	444			357		
vC1, stage 1 conf vol												
vC2, stage 2 conf vol												
vCu, unblocked vol	1081	1071	313	1154	1204	365	444			357		
tC, single (s)	7.1	6.5	6.2	7.1	6.5	6.2	4.1			4.1		
tC, 2 stage (s)												
tF (s)	3.5	4.0	3.3	3.5	4.0	3.3	2.2			2.2		
p0 queue free %	0	100	74	95	100	100	82			100		
cM capacity (veh/h)	164	180	721	110	150	679	1104			1212		
Direction, Lane #	EB 1	WB 1	NB 1	SB 1								
Volume Total	443	8	557	431								
Volume Left	253	6	201	0								
Volume Right	190	2	0	264								
cSH	255	145	1104	1212								
Volume to Capacity	1.73	0.06	0.18	0.00								
Queue Length 95th (ft)	727	4	17	0								
Control Delay (s)	379.0	31.3	4.6	0.0								
Lane LOS	F	D	A									
Approach Delay (s)	379.0	31.3	4.6	0.0								
Approach LOS	F	D										
Intersection Summary												
Average Delay			118.5									
Intersection Capacity Utilization			74.1%		ICU Level of Service					D		
Analysis Period (min)			15									

2035 Background Traffic PM Peak Hour
7: Villa Rd & Hwy 99W

												
Movement	EBL	EBT	EBR	WBL	WBT	WBR	NBL	NBT	NBR	SBL	SBT	SBR
Lane Configurations		 			 			 			 	
Volume (vph)	85	1295	10	75	1670	175	985	255	65	220	165	90
Ideal Flow (vphpl)	1900	1900	1900	1900	1900	1900	1900	1900	1900	1900	1900	1900
Total Lost time (s)	4.5	4.5		4.5	4.5		4.5	5.0		4.5	5.0	5.0
Lane Util. Factor	1.00	0.95		1.00	0.91		0.97	1.00		1.00	1.00	1.00
Frbp, ped/bikes	1.00	1.00		1.00	1.00		1.00	1.00		1.00	1.00	0.96
Flpb, ped/bikes	1.00	1.00		1.00	1.00		1.00	1.00		1.00	1.00	1.00
Frt	1.00	1.00		1.00	0.99		1.00	0.97		1.00	1.00	0.85
Flt Protected	0.95	1.00		0.95	1.00		0.95	1.00		0.95	1.00	1.00
Satd. Flow (prot)	1805	3467		1805	4962		3335	1785		1805	1900	1519
Flt Permitted	0.95	1.00		0.95	1.00		0.95	1.00		0.95	1.00	1.00
Satd. Flow (perm)	1805	3467		1805	4962		3335	1785		1805	1900	1519
Peak-hour factor, PHF	0.95	0.95	0.95	0.95	0.95	0.95	0.95	0.95	0.95	0.95	0.95	0.95
Adj. Flow (vph)	89	1363	11	79	1758	184	1037	268	68	232	174	95
RTOR Reduction (vph)	0	1	0	0	7	0	0	11	0	0	0	73
Lane Group Flow (vph)	89	1373	0	79	1935	0	1037	325	0	232	174	22
Confl. Peds. (#/hr)	1		15	15		1	25		6	6		25
Confl. Bikes (#/hr)						2			1			1
Heavy Vehicles (%)	0%	4%	0%	0%	3%	1%	5%	2%	6%	0%	0%	2%
Turn Type	Prot	NA		Prot	NA		Prot	NA		Prot	NA	Perm
Protected Phases	7	4		3	8		5	2		1	6	
Permitted Phases												6
Actuated Green, G (s)	10.8	53.9		8.9	52.0		10.5	28.2		10.5	28.2	28.2
Effective Green, g (s)	10.8	53.9		8.9	52.0		10.5	28.2		10.5	28.2	28.2
Actuated g/C Ratio	0.09	0.45		0.07	0.43		0.09	0.23		0.09	0.23	0.23
Clearance Time (s)	4.5	4.5		4.5	4.5		4.5	5.0		4.5	5.0	5.0
Vehicle Extension (s)	2.5	2.5		2.5	2.5		2.5	4.2		2.5	4.2	4.2
Lane Grp Cap (vph)	162	1557		133	2150		291	419		157	446	356
v/s Ratio Prot	c0.05	c0.40		0.04	0.39		c0.31	c0.18		0.13	0.09	
v/s Ratio Perm												0.01
v/c Ratio	0.55	0.88		0.59	0.90		3.56	0.78		1.48	0.39	0.06
Uniform Delay, d1	52.3	30.2		53.8	31.6		54.8	42.9		54.8	38.7	35.6
Progression Factor	1.00	1.00		1.00	1.00		1.00	1.00		1.00	1.00	1.00
Incremental Delay, d2	3.0	6.2		5.8	5.6		1162.1	13.2		246.0	2.6	0.3
Delay (s)	55.3	36.4		59.6	37.2		1216.9	56.1		300.7	41.2	36.0
Level of Service	E	D		E	D		F	E		F	D	D
Approach Delay (s)		37.5			38.1			932.8			160.4	
Approach LOS		D			D			F			F	

Intersection Summary

HCM 2000 Control Delay	278.7	HCM 2000 Level of Service	F
HCM 2000 Volume to Capacity ratio	1.11		
Actuated Cycle Length (s)	120.0	Sum of lost time (s)	18.5
Intersection Capacity Utilization	111.3%	ICU Level of Service	H
Analysis Period (min)	15		

c Critical Lane Group

2035 Background Traffic PM Peak Hour
7: Villa Rd & Hwy 99W

Movement	EBL	EBT	EBR	WBL	WBT	WBR	NBL	NBT	NBR	SBL	SBT	SBR
Lane Configurations												
Volume (veh/h)	85	1295	10	75	1670	175	985	255	65	220	165	90
Number	7	4	14	3	8	18	5	2	12	1	6	16
Initial Q (Qb), veh	0	0	0	0	0	0	0	0	0	0	0	0
Ped-Bike Adj(A_pbT)	1.00		0.97	1.00		0.95	1.00		0.97	1.00		0.97
Parking Bus, Adj	1.00	1.00	1.00	1.00	1.00	1.00	1.00	1.00	1.00	1.00	1.00	1.00
Adj Sat Flow, veh/h/ln	1900	1827	1900	1900	1848	1900	1810	1848	1900	1900	1900	1863
Adj Flow Rate, veh/h	89	1363	11	79	1758	184	1037	268	68	232	174	95
Adj No. of Lanes	1	2	0	1	3	0	2	1	0	1	1	1
Peak Hour Factor	0.95	0.95	0.95	0.95	0.95	0.95	0.95	0.95	0.95	0.95	0.95	0.95
Percent Heavy Veh, %	0	4	4	0	3	3	5	2	2	0	0	2
Cap, veh/h	111	867	7	100	1105	115	247	700	178	134	940	762
Arrive On Green	0.06	0.25	0.25	0.06	0.24	0.24	0.07	0.49	0.49	0.07	0.49	0.49
Sat Flow, veh/h	1810	3529	28	1810	4614	481	3343	1414	359	1810	1900	1540
Grp Volume(v), veh/h	89	670	704	79	1279	663	1037	0	336	232	174	95
Grp Sat Flow(s),veh/h/ln	1810	1736	1821	1810	1682	1731	1672	0	1773	1810	1900	1540
Q Serve(g_s), s	6.9	34.9	34.9	6.1	34.0	34.0	10.5	0.0	16.8	10.5	7.2	4.7
Cycle Q Clear(g_c), s	6.9	34.9	34.9	6.1	34.0	34.0	10.5	0.0	16.8	10.5	7.2	4.7
Prop In Lane	1.00		0.02	1.00		0.28	1.00		0.20	1.00		1.00
Lane Grp Cap(c), veh/h	111	426	447	100	805	415	247	0	877	134	940	762
V/C Ratio(X)	0.80	1.57	1.57	0.79	1.59	1.60	4.19	0.00	0.38	1.73	0.19	0.12
Avail Cap(c_a), veh/h	299	426	447	299	805	415	247	0	877	134	940	762
HCM Platoon Ratio	1.00	1.00	1.00	1.00	1.00	1.00	1.00	1.00	1.00	1.00	1.00	1.00
Upstream Filter(I)	1.00	1.00	1.00	1.00	1.00	1.00	1.00	0.00	1.00	1.00	1.00	1.00
Uniform Delay (d), s/veh	65.8	53.6	53.6	66.3	54.0	54.0	65.8	0.0	22.4	65.8	19.9	19.3
Incr Delay (d2), s/veh	9.4	268.5	268.4	9.8	270.6	280.8	1447.1	0.0	1.3	359.5	0.4	0.3
Initial Q Delay(d3),s/veh	0.0	0.0	0.0	0.0	0.0	0.0	0.0	0.0	0.0	0.0	0.0	0.0
%ile BackOfQ(50%),veh/ln	3.8	48.5	50.9	3.3	46.0	48.6	54.5	0.0	8.5	18.6	3.9	2.1
LnGrp Delay(d),s/veh	75.1	322.0	321.9	76.0	324.6	334.8	1512.9	0.0	23.6	425.2	20.4	19.6
LnGrp LOS	E	F	F	E	F	F	F		C	F	C	B
Approach Vol, veh/h		1463			2021			1373			501	
Approach Delay, s/veh		307.0			318.2			1148.4			207.7	
Approach LOS		F			F			F			F	
Timer	1	2	3	4	5	6	7	8				
Assigned Phs	1	2	3	4	5	6	7	8				
Phs Duration (G+Y+Rc), s	15.0	75.3	12.4	39.4	15.0	75.3	13.2	38.5				
Change Period (Y+Rc), s	4.5	5.0	4.5	4.5	4.5	5.0	4.5	4.5				
Max Green Setting (Gmax), s	10.5	55.0	23.5	31.0	10.5	55.0	23.5	34.0				
Max Q Clear Time (g_c+I1), s	12.5	18.8	8.1	36.9	12.5	9.2	8.9	36.0				
Green Ext Time (p_c), s	0.0	5.9	0.1	0.0	0.0	6.1	0.1	0.0				
Intersection Summary												
HCM 2010 Ctrl Delay			517.6									
HCM 2010 LOS			F									

Appendix H Year 2035 Total Traffic Level-of-
Service Worksheets

2035 Total Traffic PM Peak Hour
1: Aldersgate Ln & E Crestview Dr











	→	↘	↙	←	↖	↗
Movement	EBT	EBR	WBL	WBT	NBL	NBR
Lane Configurations	↗			↖	↗	
Volume (veh/h)	88	8	5	175	4	3
Sign Control	Free			Free	Stop	
Grade	0%			0%	0%	
Peak Hour Factor	0.83	0.83	0.83	0.83	0.83	0.83
Hourly flow rate (vph)	106	10	6	211	5	4
Pedestrians	4			1	4	
Lane Width (ft)	12.0			12.0	12.0	
Walking Speed (ft/s)	4.0			4.0	4.0	
Percent Blockage	0			0	0	
Right turn flare (veh)						
Median type	None			None		
Median storage (veh)						
Upstream signal (ft)						
pX, platoon unblocked						
vC, conflicting volume			120		342	116
vC1, stage 1 conf vol						
vC2, stage 2 conf vol						
vCu, unblocked vol			120		342	116
tC, single (s)			4.1		6.4	6.2
tC, 2 stage (s)						
tF (s)			2.2		3.5	3.3
p0 queue free %			100		99	100
cM capacity (veh/h)			1476		651	938
Direction, Lane #	EB 1	WB 1	NB 1			
Volume Total	116	217	8			
Volume Left	0	6	5			
Volume Right	10	0	4			
cSH	1700	1476	750			
Volume to Capacity	0.07	0.00	0.01			
Queue Length 95th (ft)	0	0	1			
Control Delay (s)	0.0	0.2	9.9			
Lane LOS		A	A			
Approach Delay (s)	0.0	0.2	9.9			
Approach LOS			A			
Intersection Summary						
Average Delay			0.4			
Intersection Capacity Utilization			23.6%	ICU Level of Service		A
Analysis Period (min)			15			

2035 Total Traffic PM Peak Hour
2: Aldersgate Ln & Park Ln



Movement	WBL	WBR	NBT	NBR	SBL	SBT
Lane Configurations	Y		T			T
Volume (veh/h)	81	12	3	33	13	2
Sign Control	Stop		Free			Free
Grade	0%		0%			0%
Peak Hour Factor	0.71	0.71	0.71	0.71	0.71	0.71
Hourly flow rate (vph)	114	17	4	46	18	3
Pedestrians	1		1			
Lane Width (ft)	12.0		12.0			
Walking Speed (ft/s)	4.0		4.0			
Percent Blockage	0		0			
Right turn flare (veh)						
Median type			None			None
Median storage (veh)						
Upstream signal (ft)						
pX, platoon unblocked						
vC, conflicting volume	69	28			52	
vC1, stage 1 conf vol						
vC2, stage 2 conf vol						
vCu, unblocked vol	69	28			52	
tC, single (s)	6.4	6.3			4.1	
tC, 2 stage (s)						
tF (s)	3.5	3.4			2.2	
p0 queue free %	88	98			99	
cM capacity (veh/h)	923	1012			1566	
Direction, Lane #	WB 1	NB 1	SB 1			
Volume Total	131	51	21			
Volume Left	114	0	18			
Volume Right	17	46	0			
cSH	934	1700	1566			
Volume to Capacity	0.14	0.03	0.01			
Queue Length 95th (ft)	12	0	1			
Control Delay (s)	9.5	0.0	6.4			
Lane LOS	A		A			
Approach Delay (s)	9.5	0.0	6.4			
Approach LOS	A					
Intersection Summary						
Average Delay			6.8			
Intersection Capacity Utilization			19.4%	ICU Level of Service		A
Analysis Period (min)			15			

2035 Total Traffic PM Peak Hour
4: Villa Rd & Park Ln

















						
Movement	EBL	EBR	NBL	NBT	SBT	SBR
Lane Configurations						
Volume (veh/h)	4	41	81	339	242	11
Sign Control	Stop			Free	Free	
Grade	0%			0%	0%	
Peak Hour Factor	0.85	0.85	0.85	0.85	0.85	0.85
Hourly flow rate (vph)	5	48	95	399	285	13
Pedestrians					1	
Lane Width (ft)					12.0	
Walking Speed (ft/s)					4.0	
Percent Blockage					0	
Right turn flare (veh)						
Median type				None	None	
Median storage (veh)						
Upstream signal (ft)						
pX, platoon unblocked						
vC, conflicting volume	882	291	298			
vC1, stage 1 conf vol						
vC2, stage 2 conf vol						
vCu, unblocked vol	882	291	298			
tC, single (s)	6.4	6.2	4.1			
tC, 2 stage (s)						
tF (s)	3.5	3.3	2.2			
p0 queue free %	98	94	93			
cM capacity (veh/h)	295	753	1275			
Direction, Lane #	EB 1	EB 2	NB 1	SB 1		
Volume Total	5	48	494	298		
Volume Left	5	0	95	0		
Volume Right	0	48	0	13		
cSH	295	753	1275	1700		
Volume to Capacity	0.02	0.06	0.07	0.18		
Queue Length 95th (ft)	1	5	6	0		
Control Delay (s)	17.4	10.1	2.2	0.0		
Lane LOS	C	B	A			
Approach Delay (s)	10.8		2.2	0.0		
Approach LOS	B					
Intersection Summary						
Average Delay			2.0			
Intersection Capacity Utilization			49.1%	ICU Level of Service		A
Analysis Period (min)			15			

2035 Total Traffic PM Peak Hour
5: Villa Rd & Site Access



Movement	EBL	EBR	NBL	NBT	SBT	SBR
Lane Configurations	Y			↑	↑	
Volume (veh/h)	2	28	54	419	281	3
Sign Control	Stop			Free	Free	
Grade	0%			0%	0%	
Peak Hour Factor	0.69	0.69	0.69	0.69	0.69	0.69
Hourly flow rate (vph)	3	41	78	607	407	4
Pedestrians				1	2	
Lane Width (ft)				12.0	12.0	
Walking Speed (ft/s)				4.0	4.0	
Percent Blockage				0	0	
Right turn flare (veh)						
Median type				None	None	
Median storage (veh)						
Upstream signal (ft)						
pX, platoon unblocked						
vC, conflicting volume	1175	410	412			
vC1, stage 1 conf vol						
vC2, stage 2 conf vol						
vCu, unblocked vol	1175	410	412			
tC, single (s)	6.4	6.2	4.1			
tC, 2 stage (s)						
tF (s)	3.5	3.3	2.2			
p0 queue free %	99	94	93			
cM capacity (veh/h)	199	645	1158			
Direction, Lane #	EB 1	NB 1	SB 1			
Volume Total	43	686	412			
Volume Left	3	78	0			
Volume Right	41	0	4			
cSH	561	1158	1700			
Volume to Capacity	0.08	0.07	0.24			
Queue Length 95th (ft)	6	5	0			
Control Delay (s)	12.0	1.7	0.0			
Lane LOS	B	A				
Approach Delay (s)	12.0	1.7	0.0			
Approach LOS	B					
Intersection Summary						
Average Delay			1.5			
Intersection Capacity Utilization			53.7%	ICU Level of Service	A	
Analysis Period (min)			15			

2035 Total Traffic PM Peak Hour
6: Villa Rd & Fulton St

												
Movement	EBL	EBT	EBR	WBL	WBT	WBR	NBL	NBT	NBR	SBL	SBT	SBR
Lane Configurations												
Volume (veh/h)	220	0	165	5	0	2	175	347	9	0	163	230
Sign Control		Stop			Stop			Free			Free	
Grade		0%			0%			0%			0%	
Peak Hour Factor	0.87	0.87	0.87	0.87	0.87	0.87	0.87	0.87	0.87	0.87	0.87	0.87
Hourly flow rate (vph)	253	0	190	6	0	2	201	399	10	0	187	264
Pedestrians		13			1			1			8	
Lane Width (ft)		12.0			12.0			12.0			12.0	
Walking Speed (ft/s)		4.0			4.0			4.0			4.0	
Percent Blockage		1			0			0			1	
Right turn flare (veh)			6									
Median type								None			None	
Median storage (veh)												
Upstream signal (ft)												
pX, platoon unblocked												
vC, conflicting volume	1149	1145	334	1223	1272	413	465			410		
vC1, stage 1 conf vol												
vC2, stage 2 conf vol												
vCu, unblocked vol	1149	1145	334	1223	1272	413	465			410		
tC, single (s)	7.1	6.5	6.2	7.1	6.5	6.2	4.1			4.1		
tC, 2 stage (s)												
tF (s)	3.5	4.0	3.3	3.5	4.0	3.3	2.2			2.2		
p0 queue free %	0	100	73	94	100	100	81			100		
cM capacity (veh/h)	147	162	702	98	136	639	1085			1159		
Direction, Lane #	EB 1	WB 1	NB 1	SB 1								
Volume Total	443	8	610	452								
Volume Left	253	6	201	0								
Volume Right	190	2	10	264								
cSH	229	129	1085	1159								
Volume to Capacity	1.93	0.06	0.19	0.00								
Queue Length 95th (ft)	798	5	17	0								
Control Delay (s)	471.0	34.8	4.5	0.0								
Lane LOS	F	D	A									
Approach Delay (s)	471.0	34.8	4.5	0.0								
Approach LOS	F	D										
Intersection Summary												
Average Delay			139.8									
Intersection Capacity Utilization			77.5%		ICU Level of Service					D		
Analysis Period (min)			15									

2035 Total Traffic PM Peak Hour
7: Villa Rd & Hwy 99W

Movement	EBL	EBT	EBR	WBL	WBT	WBR	NBL	NBT	NBR	SBL	SBT	SBR
Lane Configurations												
Volume (vph)	95	1295	10	75	1670	185	985	260	65	225	167	95
Ideal Flow (vphpl)	1900	1900	1900	1900	1900	1900	1900	1900	1900	1900	1900	1900
Total Lost time (s)	4.5	4.5		4.5	4.5		4.5	5.0		4.5	5.0	5.0
Lane Util. Factor	1.00	0.95		1.00	0.91		0.97	1.00		1.00	1.00	1.00
Frbp, ped/bikes	1.00	1.00		1.00	1.00		1.00	1.00		1.00	1.00	0.96
Flpb, ped/bikes	1.00	1.00		1.00	1.00		1.00	1.00		1.00	1.00	1.00
Frt	1.00	1.00		1.00	0.99		1.00	0.97		1.00	1.00	0.85
Flt Protected	0.95	1.00		0.95	1.00		0.95	1.00		0.95	1.00	1.00
Satd. Flow (prot)	1805	3467		1805	4958		3335	1786		1805	1900	1519
Flt Permitted	0.95	1.00		0.95	1.00		0.95	1.00		0.95	1.00	1.00
Satd. Flow (perm)	1805	3467		1805	4958		3335	1786		1805	1900	1519
Peak-hour factor, PHF	0.95	0.95	0.95	0.95	0.95	0.95	0.95	0.95	0.95	0.95	0.95	0.95
Adj. Flow (vph)	100	1363	11	79	1758	195	1037	274	68	237	176	100
RTOR Reduction (vph)	0	1	0	0	7	0	0	11	0	0	0	76
Lane Group Flow (vph)	100	1373	0	79	1946	0	1037	331	0	237	176	24
Confl. Peds. (#/hr)	1		15	15		1	25		6	6		25
Confl. Bikes (#/hr)						2			1			1
Heavy Vehicles (%)	0%	4%	0%	0%	3%	1%	5%	2%	6%	0%	0%	2%
Turn Type	Prot	NA		Prot	NA		Prot	NA		Prot	NA	Perm
Protected Phases	7	4		3	8		5	2		1	6	
Permitted Phases												6
Actuated Green, G (s)	11.5	53.5		8.9	50.9		10.5	28.6		10.5	28.6	28.6
Effective Green, g (s)	11.5	53.5		8.9	50.9		10.5	28.6		10.5	28.6	28.6
Actuated g/C Ratio	0.10	0.45		0.07	0.42		0.09	0.24		0.09	0.24	0.24
Clearance Time (s)	4.5	4.5		4.5	4.5		4.5	5.0		4.5	5.0	5.0
Vehicle Extension (s)	2.5	2.5		2.5	2.5		2.5	4.2		2.5	4.2	4.2
Lane Grp Cap (vph)	172	1545		133	2103		291	425		157	452	362
v/s Ratio Prot	c0.06	c0.40		0.04	0.39		c0.31	c0.19		0.13	0.09	
v/s Ratio Perm												0.02
v/c Ratio	0.58	0.89		0.59	0.93		3.56	0.78		1.51	0.39	0.07
Uniform Delay, d1	51.9	30.5		53.8	32.7		54.8	42.8		54.8	38.4	35.4
Progression Factor	1.00	1.00		1.00	1.00		1.00	1.00		1.00	1.00	1.00
Incremental Delay, d2	4.1	6.6		5.8	7.5		1162.1	13.2		259.3	2.5	0.4
Delay (s)	56.0	37.1		59.6	40.3		1216.9	56.0		314.1	40.9	35.7
Level of Service	E	D		E	D		F	E		F	D	D
Approach Delay (s)		38.4			41.0			929.0			166.1	
Approach LOS		D			D			F			F	

Intersection Summary

HCM 2000 Control Delay	279.0	HCM 2000 Level of Service	F
HCM 2000 Volume to Capacity ratio	1.12		
Actuated Cycle Length (s)	120.0	Sum of lost time (s)	18.5
Intersection Capacity Utilization	111.8%	ICU Level of Service	H
Analysis Period (min)	15		

















c Critical Lane Group

2035 Total Traffic PM Peak Hour
7: Villa Rd & Hwy 99W

Movement	EBL	EBT	EBR	WBL	WBT	WBR	NBL	NBT	NBR	SBL	SBT	SBR
Lane Configurations												
Volume (veh/h)	95	1295	10	75	1670	185	985	260	65	225	167	95
Number	7	4	14	3	8	18	5	2	12	1	6	16
Initial Q (Qb), veh	0	0	0	0	0	0	0	0	0	0	0	0
Ped-Bike Adj(A_pbT)	1.00		0.97	1.00		0.95	1.00		0.97	1.00		0.97
Parking Bus, Adj	1.00	1.00	1.00	1.00	1.00	1.00	1.00	1.00	1.00	1.00	1.00	1.00
Adj Sat Flow, veh/h/ln	1900	1827	1900	1900	1848	1900	1810	1848	1900	1900	1900	1863
Adj Flow Rate, veh/h	100	1363	11	79	1758	195	1037	274	68	237	176	100
Adj No. of Lanes	1	2	0	1	3	0	2	1	0	1	1	1
Peak Hour Factor	0.95	0.95	0.95	0.95	0.95	0.95	0.95	0.95	0.95	0.95	0.95	0.95
Percent Heavy Veh, %	0	4	4	0	3	3	5	2	2	0	0	2
Cap, veh/h	123	890	7	100	1097	121	247	694	172	134	928	752
Arrive On Green	0.07	0.25	0.25	0.06	0.24	0.24	0.07	0.49	0.49	0.07	0.49	0.49
Sat Flow, veh/h	1810	3529	28	1810	4584	506	3343	1422	353	1810	1900	1540
Grp Volume(v), veh/h	100	670	704	79	1288	665	1037	0	342	237	176	100
Grp Sat Flow(s),veh/h/ln	1810	1736	1821	1810	1682	1725	1672	0	1774	1810	1900	1540
Q Serve(g_s), s	7.7	35.8	35.8	6.1	34.0	34.0	10.5	0.0	17.4	10.5	7.4	5.0
Cycle Q Clear(g_c), s	7.7	35.8	35.8	6.1	34.0	34.0	10.5	0.0	17.4	10.5	7.4	5.0
Prop In Lane	1.00		0.02	1.00		0.29	1.00		0.20	1.00		1.00
Lane Grp Cap(c), veh/h	123	438	459	100	805	413	247	0	866	134	928	752
V/C Ratio(X)	0.81	1.53	1.53	0.79	1.60	1.61	4.19	0.00	0.39	1.77	0.19	0.13
Avail Cap(c_a), veh/h	299	438	459	299	805	413	247	0	866	134	928	752
HCM Platoon Ratio	1.00	1.00	1.00	1.00	1.00	1.00	1.00	1.00	1.00	1.00	1.00	1.00
Upstream Filter(I)	1.00	1.00	1.00	1.00	1.00	1.00	1.00	0.00	1.00	1.00	1.00	1.00
Uniform Delay (d), s/veh	65.3	53.1	53.1	66.3	54.0	54.0	65.8	0.0	23.0	65.8	20.5	19.9
Incr Delay (d2), s/veh	9.1	250.1	250.0	9.8	275.2	285.9	1447.1	0.0	1.3	375.6	0.5	0.4
Initial Q Delay(d3),s/veh	0.0	0.0	0.0	0.0	0.0	0.0	0.0	0.0	0.0	0.0	0.0	0.0
%ile BackOfQ(50%),veh/ln	4.2	47.6	49.9	3.3	46.6	49.0	54.5	0.0	8.8	19.2	4.0	2.2
LnGrp Delay(d),s/veh	74.3	303.2	303.1	76.0	329.2	339.9	1512.9	0.0	24.4	441.4	21.0	20.3
LnGrp LOS	E	F	F	E	F	F	F		C	F	C	C
Approach Vol, veh/h		1474			2032			1379			513	
Approach Delay, s/veh		287.6			322.9			1143.7			215.0	
Approach LOS		F			F			F			F	
Timer	1	2	3	4	5	6	7	8				
Assigned Phs	1	2	3	4	5	6	7	8				
Phs Duration (G+Y+Rc), s	15.0	74.3	12.4	40.3	15.0	74.3	14.2	38.5				
Change Period (Y+Rc), s	4.5	5.0	4.5	4.5	4.5	5.0	4.5	4.5				
Max Green Setting (Gmax), s	10.5	55.0	23.5	31.0	10.5	55.0	23.5	34.0				
Max Q Clear Time (g_c+I1), s	12.5	19.4	8.1	37.8	12.5	9.4	9.7	36.0				
Green Ext Time (p_c), s	0.0	6.0	0.1	0.0	0.0	6.3	0.1	0.0				
Intersection Summary												
HCM 2010 Ctrl Delay			512.7									
HCM 2010 LOS			F									

Appendix I Year 2035 Total Traffic
Conditions Worksheets-
Mitigated

2035 Mitigated Total Traffic PM Peak Hour
6: Villa Rd & Fulton St

												
Movement	EBL	EBT	EBR	WBL	WBT	WBR	NBL	NBT	NBR	SBL	SBT	SBR
Lane Configurations												
Sign Control		Stop			Stop			Stop			Stop	
Volume (vph)	220	0	165	5	0	2	175	347	9	0	163	230
Peak Hour Factor	0.87	0.87	0.87	0.87	0.87	0.87	0.87	0.87	0.87	0.87	0.87	0.87
Hourly flow rate (vph)	253	0	190	6	0	2	201	399	10	0	187	264
Direction, Lane #	EB 1	EB 2	WB 1	NB 1	SB 1							
Volume Total (vph)	253	190	8	610	452							
Volume Left (vph)	253	0	6	201	0							
Volume Right (vph)	0	190	2	10	264							
Hadj (s)	0.52	-0.68	-0.03	0.08	-0.33							
Departure Headway (s)	7.8	6.6	8.3	6.2	6.0							
Degree Utilization, x	0.55	0.35	0.02	1.00	0.75							
Capacity (veh/h)	451	530	387	610	587							
Control Delay (s)	18.8	12.0	11.5	62.2	25.2							
Approach Delay (s)	15.9		11.5	62.2	25.2							
Approach LOS	C		B	F	D							
Intersection Summary												
Delay			37.3									
Level of Service			E									
Intersection Capacity Utilization			77.5%	ICU Level of Service	D							
Analysis Period (min)			15									



KITTELSON & ASSOCIATES, INC.

TRANSPORTATION ENGINEERING / PLANNING

610 SW Alder Street, Suite 700, Portland, OR 97205 P 503.228.5230 F 503.273.8169

MEMORANDUM

Date: April 2, 2015

To: Steve Olson, City of Newberg Planning Division

From: Brian J. Dunn, P.E., Patrick Marnell E.I.T

Project: Martell Commons

Subject: Supplemental Analysis - Crestview Drive/Villa Road intersection

Project #: 18152



Per the City of Newberg's completeness comments received on March 25, 2015 for the Martell Commons comprehensive plan map/zoning map amendment, a supplemental traffic analysis of the Crestview Drive/Villa Road intersection has been prepared.

Per the direction of City staff, traffic volumes for the year 2035 weekday p.m. peak hour were developed at the Crestview Drive/Villa Road intersection based on the base counts and forecast volumes of adjacent intersections presented in our Martell Commons Traffic Impact Analysis report. Site generated trips were also assigned to the Crestview Drive/Villa Road intersection in a pattern consistent with the distribution presented in the Martell Commons Traffic Impact Analysis report.

Figure 1 summarizes the assumed intersection configuration, forecast background volumes, site generated trip assignments, and forecast total traffic volumes at the Crestview Drive/Villa Road intersection during the 2035 weekday p.m. peak hour. Figure 1 also summarizes the results of the traffic operations analysis at this intersection. As shown, the Crestview Drive/Villa Road intersection is forecast to operate at LOS "B" and well within the City's LOS "D" or better standards for both background and total traffic conditions during the 2035 weekday p.m. peak hour. *Attachment "A" contains the 2035 traffic operations worksheets.*

Additional analysis was also conducted to assess site build-out year (2016) operations for the weekday a.m. peak hour. The Crestview Drive/Villa Road intersection is forecast with operate at LOS "A" and well within the City's LOS "D" or better standard during the 2016 weekday a.m. peak hour. *Attachment "B" contains 2016 the traffic operations worksheet.* The build-out year volumes for the p.m. peak hour were assumed to be less than the 2035 p.m. peak hour and were not analyzed.

The supplemental analysis results presented herein do not alter our original conclusions in the Martell Commons TIA that the transportation system can operate adequately and safely with proposed mitigation measures in place.

H:\profile\18152 - Villa Road Apartments\dwgs\18152_figs-additional.dwg Apr 02, 2015 - 9:48am - pmarnell Layout Tab: S1

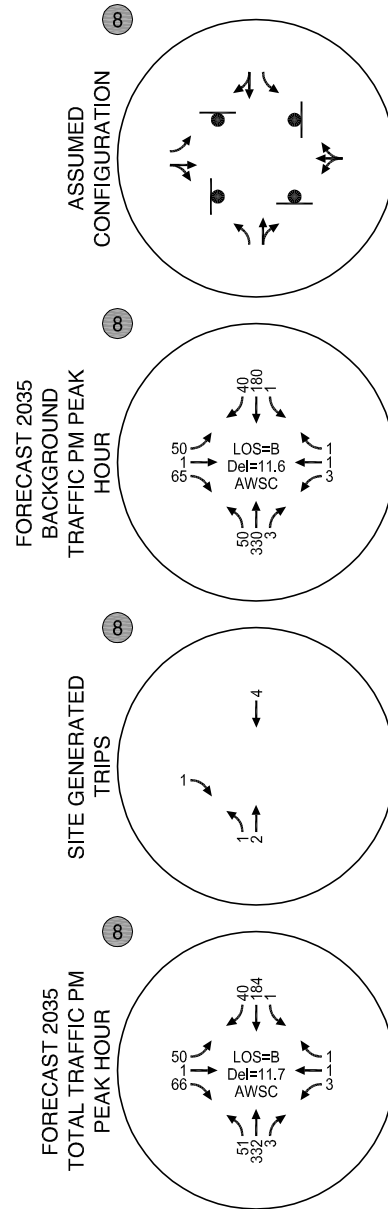

LEGEND

- STOP SIGN

- TRAFFIC SIGNAL

Del = INTERSECTION AVERAGE CONTROL DELAY



















AWSC = ALL-WAY STOP CONTROL

2035 PM PEAK HOUR SUPPLEMENTAL ANALYSIS
CRESTVIEW DRIVE AND VILLA ROAD
NEWBERG, OREGON



















FIGURE
1

Attachment A
2035 PM Peak Hour
Background and Total
Traffic Conditions

2035 Background Traffic PM Peak Hour
8: Villa Rd & E Crestview Dr

															
Movement	EBL	EBT	EBR	WBL	WBT	WBR	NBL	NBT	NBR	SBL	SBT	SBR			
Lane Configurations															
Sign Control	Stop				Stop			Stop			Stop				
Volume (vph)	50	1	65	3	1	1	50	330	3	1	180	40			
Peak Hour Factor	0.85	0.85	0.85	0.85	0.85	0.85	0.85	0.85	0.85	0.85	0.85	0.85			
Hourly flow rate (vph)	59	1	76	4	1	1	59	388	4	1	212	47			
Direction, Lane #	EB 1	EB 2	WB 1	NB 1	NB 2	SB 1	SB 2								
Volume Total (vph)	59	78	6	59	392	1	259								
Volume Left (vph)	59	0	4	59	0	1	0								
Volume Right (vph)	0	76	1	0	4	0	47								
Hadj (s)	0.58	-0.60	0.09	0.58	0.08	0.58	-0.04								
Departure Headway (s)	6.8	5.6	6.5	5.8	5.3	6.0	5.4								
Degree Utilization, x	0.11	0.12	0.01	0.09	0.57	0.00	0.39								
Capacity (veh/h)	486	581	486	603	670	576	652								
Control Delay (s)	9.5	8.2	9.6	8.2	13.9	7.8	10.5								
Approach Delay (s)	8.7		9.6	13.2		10.5									
Approach LOS	A		A	B		B									
Intersection Summary															
Delay			11.6												
Level of Service			B												
Intersection Capacity Utilization			35.0%				ICU Level of Service				A				
Analysis Period (min)			15												

2035 Total Traffic PM Peak Hour
8: Villa Rd & E Crestview Dr

															
Movement	EBL	EBT	EBR	WBL	WBT	WBR	NBL	NBT	NBR	SBL	SBT	SBR			
Lane Configurations															
Sign Control	Stop				Stop			Stop			Stop				
Volume (vph)	50	1	66	3	1	1	51	332	3	1	184	40			
Peak Hour Factor	0.85	0.85	0.85	0.85	0.85	0.85	0.85	0.85	0.85	0.85	0.85	0.85			
Hourly flow rate (vph)	59	1	78	4	1	1	60	391	4	1	216	47			
Direction, Lane #	EB 1	EB 2	WB 1	NB 1	NB 2	SB 1	SB 2								
Volume Total (vph)	59	79	6	60	394	1	264								
Volume Left (vph)	59	0	4	60	0	1	0								
Volume Right (vph)	0	78	1	0	4	0	47								
Hadj (s)	0.58	-0.60	0.09	0.58	0.08	0.58	-0.04								
Departure Headway (s)	6.8	5.6	6.6	5.8	5.3	6.0	5.4								
Degree Utilization, x	0.11	0.12	0.01	0.10	0.58	0.00	0.39								
Capacity (veh/h)	484	579	484	602	668	575	651								
Control Delay (s)	9.5	8.2	9.6	8.2	14.1	7.8	10.6								
Approach Delay (s)	8.8		9.6	13.3		10.6									
Approach LOS	A		A	B		B									
Intersection Summary															
Delay			11.7												
Level of Service			B												
Intersection Capacity Utilization			35.2%				ICU Level of Service				A				
Analysis Period (min)			15												

Attachment B
2016 AM Peak Hour Total
Traffic Conditions

2016 Total Traffic AM Peak Hour
8: Villa Rd & E Crestview Dr



















												
Movement	EBL	EBT	EBR	WBL	WBT	WBR	NBL	NBT	NBR	SBL	SBT	SBR
Lane Configurations												
Sign Control	Stop				Stop			Stop			Stop	
Volume (vph)	80	1	90	3	1	1	36	124	3	1	196	55
Peak Hour Factor	0.85	0.85	0.85	0.85	0.85	0.85	0.85	0.85	0.85	0.85	0.85	0.85
Hourly flow rate (vph)	94	1	106	4	1	1	42	146	4	1	231	65
Direction, Lane #	EB 1	EB 2	WB 1	NB 1	NB 2	SB 1	SB 2					
Volume Total (vph)	94	107	6	42	149	1	295					
Volume Left (vph)	94	0	4	42	0	1	0					
Volume Right (vph)	0	106	1	0	4	0	65					
Hadj (s)	0.58	-0.61	0.09	0.58	0.07	0.58	-0.07					
Departure Headway (s)	6.3	5.1	6.1	6.0	5.5	5.9	5.2					
Degree Utilization, x	0.16	0.15	0.01	0.07	0.23	0.00	0.43					
Capacity (veh/h)	534	651	530	577	633	584	667					
Control Delay (s)	9.4	7.8	9.2	8.2	8.8	7.7	10.9					
Approach Delay (s)	8.5		9.2		8.7		10.9					
Approach LOS	A		A		A		B					
Intersection Summary												
Delay			9.6									
Level of Service			A									
Intersection Capacity Utilization			33.9%		ICU Level of Service		A					
Analysis Period (min)			15									



EXHIBIT G: HOUSING NEEDS ANALYSIS

Draft City of Newberg Housing Needs Analysis February 11, 2015

1. Introduction

Martell Commons, LLC (Applicant) is planning a multi-family development called Martell Commons on the property located at 1317 Villa Road. The property is approximately 5.94 acres in size, located entirely within the City of Newberg and zoned R-1. The proposed development could construct up to 168 multi-family attached dwellings on the property, consistent with R-3 zoning standards. Therefore, the Applicant is proposing a zoning map amendment that would change the subject property from R-1 zoning to R-3 zoning.

Cogan Owens Greene, LLC (COG) has been retained by 3J Consulting on behalf of the Applicant to prepare a buildable lands inventory (BLI) and housing needs analysis (HNA) to assess the subsequent need for residential land in the City of Newberg should the zoning map amendment be approved. This study updates portions of the City of Newberg's Comprehensive Plan Housing Element prepared in 2008-2009, but subsequently remanded by the Land Use Board of Appeals (LUBA) in 2010.

2. Analysis

In order to evaluate the sufficiency of the buildable residential land supply as outlined in the City of Newberg's Comprehensive Plan, COG prepared a land inventory and capacity (supply) assessment, reconciled with housing and land need (demand). The LUBA decision to remand Newberg's 2009 HNA was primarily due to the use of a population forecast that had not been explicitly adopted by Yamhill County. This report addresses that issue by using *Population Forecasts for Yamhill County, its Cities and Unincorporated Area 2011-2035*, prepared by the Portland State University Population Research Center (PRC).

The remand also cites several issues with the methodology used to prepare the land inventory and capacity for the remanded 2009 HNA. Currently, a detailed description of the methodology used in 2009 is unavailable. Therefore, COG prepared a BLI using the method described in the *Planning for Residential Growth* guidebook, published by the Oregon Transportation and Growth Management Program (1996).

2.1 Housing and Land Needs (Demand)

In October 2012, the Yamhill County Planning Commission adopted a new coordinated population forecast through 2035, based on the UGB population of each area within the County from the 2010 Census and population estimates from the PRC. Table 1 shows a 2030 population of 35,408 for Newberg according to the 2012 population forecast as opposed to 42,870 according to the prior population forecast used in the 2009 HNA. The slower growth forecasted by the 2012 projection results in 7,462 fewer Newberg residents in 2030.

Table 1. Newberg UGB Adopted Population Forecasts: Newberg HNA 2009 vs. Yamhill County 2012

Year	Newberg HNA (2009)	Yamhill County Projection (2012)	Difference
2015	28,559	24,663	(3,896)
2020	33,683	28,250	(5,433)
2025	38,352	32,213	(6,139)
2030	42,870	35,408	(7,462)

In addition to the population forecast from Table 1, COG used the following data to determine the projected number of new housing units needed from 2015-2030:

1. Current estimate of housing units
2. Average Household Size
3. Vacancy Rate

For the purpose of this evaluation, COG updated these variables to reflect data from 2010 Census and estimates from Newberg and the PRC, as indicated in Table 2.

Table 2. Comparison of Variables used for Calculation of Projected Number of Household Units Needed

	<i>Variable</i>		<i>Source</i>
Newberg HNA	Current Household Units	8,074 ¹	Newberg HNA
	Household Size	2.76	Newberg HNA
	Vacancy Rate	5.2%	Newberg HNA
Updated HNA	Current Household Units	8,590 ²	PSU Population Research Center; City of Newberg
	Household Size	2.66	2010 Census
	Vacancy Rate	6.4%	2010 Census

COG calculated the projected number of households by dividing the projected population for each year by household size. The total number of units needed by 2030 is calculated by subtracting the projected number of households from a current estimate of household units. A vacancy rate is then applied to this projected number of new housing units. In the case of Newberg's HNA, 49 housing units displaced by the proposed Newberg-Dundee Bypass are added to the projected number of housing units, after the vacancy rate is applied. As shown in Table 3, a total of 4,468 units will be needed to meet the housing demand in 2030.

¹ The 2009 Newberg HNA calculates the total number of housing units as 7,900 units within City boundaries, plus 174 units in the unincorporated area inside the Newberg UGB.

² As of November 2014. The current household units is calculated by adding the total number of housing units up until June 20, 2014 (received from Risa Proehl, PSU Population Research Center), with the total number of building permits issued from July 1, 2014 to November 2014 (received from Jessica Pelz, City of Newberg).

Table 3. Calculation of Projected Number of Housing Units, 2015-2030

Years	Projected Number of Households (2.66 persons per unit)	Additional Gross Number of Housing Units ³ (8,590 current units)	Vacancy Rate (6.4%)	Additional Net Number of Housing Units Needed (8,590 current units) ⁴
2015	9,272	682	(44)	638
2020	10,620	2,030	(130)	1,900
2025	12,110	3,520	(225)	3,295
2030	13,311	4,721	(302)	4,419
2030 (accounting for units lost due to Newberg-Dundee Bypass)			+ 49 units	4,468

Table 4 shows Newberg's future housing needs (number of units) by housing type using proportions assigned in the Newberg Comprehensive Plan Housing Element.

Table 4. Future Housing Needs by Housing Type, 2015 to 2030

Comp Plan Designation	Single Family		Multi-Family		Manufactured		Mixed-Use	Total
	LDR	MDR		HDR	MDR		COM	
Housing Type	Detached	Attached	Med Density	High Density	Parks	Subdivision		
Proportion	50% (40% LDR) (10% MDR)	7%	15%	23%	2%	2%	1%	100%
Units – Updated HNA	2,234	313	670	1,028	89	89	45	4,468

Table 5 shows an estimated 4,468 units needed by comprehensive plan designation through 2030: 1,787 units of Low Density Residential (LDR), 1,608 units of Medium Density Residential (MDR), 1,028 units of High Density Residential (HDR) and 45 units in commercial zones.

Table 5. Total Housing Units Needed by Comprehensive Plan Designation, 2015-2030

Plan Designation	Proportion (%)	Unites Needed
LDR	40	1,787
MDR	36	1,608
HDR	23	1,028
(COM)	1	45
Total	100	4,468

To determine the total amount of residential land needed for housing, COG divided the housing units for each category by the planned residential densities, as outlined from Newberg's Comprehensive Plan and the City's most recent revisions. For single-family residential, LDR, the target residential density is 4.4 units per gross acre.⁵ The target for MDR is 9 units/gross acre and 16.5 units/gross acre

^{3,4} If housing units remain constant at 2014 levels (8,590 units, with a 2015 population estimate of 24,663 as per Yamhill County's 2012 Adopted Population Forecast.

⁵ Minimum lot size in the R-1 zone is 5,000 sf. Target residential densities do not represent 100% development of the lot, but rather reflect the City's desired growth pattern and assume some level of underdevelopment.

for HDR. Table 6 shows the total buildable residential land needs by housing designation based on these densities. Newberg will need a total of 647 acres to accommodate housing needs in 2030, including 406 acres for LDR, 179 acres for MDR and 62 acres for HDR.

Table 6. Buildable Residential Land Needs, 2015-2030

Plan Designation	Target Density (du/gross ac.)	Housing Units Needed	Buildable Acres Needed
LDR	4.4	1,787	406
MDR	9	1,608	179
HDR	16.5	1,028	62
Total		4,423	647

2.2 Land Inventory and Capacity (Supply)

As indicated in the introduction to Section 2, COG conducted a new buildable land inventory according to the methods described in the *Planning for Residential Growth* guidebook. We obtained taxlot data from the City of Newberg in the form of an Excel spreadsheet derived from the City's GIS data. We divided the data into LDR, MDR and HDR designations, based on the "comp1" variable. Table 7 shows the gross residential land supply by zone.

Table 7. Gross Residential Land Supply by Zone

Plan Designation	Acres
LDR	1,130.8
MDR	668.5
HDR	99.6
Total	1,898.9

We subtracted environmentally constrained acreage from each taxlot's gross acreage. We then removed all taxlots with one or more housing units and less than one half acre of buildable vacant land from the inventory to determine buildable land. We summed the total amount of buildable land from the remaining taxlots across each housing designation. The result was a buildable residential land supply of approximately 467 acres; 369 acres of LDR, 92 acres of MDR and 7 acres of HDR as shown in Table 8.

Table 8. Buildable Residential Land Supply

Plan Designation	Acres
LDR	368.7
MDR	91.7
HDR	7.0
Total	467.4

A comparison of residential land needs and the buildable residential land supply shows the City of Newberg has a an overall deficit of 179 buildable residential acres; 37 acres of LDR, 87 acres of MDR and 55 acres of HDR, as shown in Table 9.

Table 9. Buildable Residential Needs vs. Supply, 2015-2030

Plan Designation	Buildable Acres Needed	Buildable Acres in UGB	Surplus (Deficit)
LDR	406	369	(37)
MDR	179	92	(87)
HDR	62	7	(55)
Total	647	468	(179)

Table 10 shows the land allocations that would result if zoning on the 5.94-acre Martell Commons site was changed from R-1 (LDR) to R-3 (HDR). If the zone change were approved, the City would have an overall deficit of 43 acres of LDR and 49 acres of HDR.

Table 10. Buildable Residential Needs vs. Supply After Zone Change, 2015-2030

Plan Designation	Buildable Acres Needed	Buildable Acres Before Zone Change	Buildable Acres After Zone Change	Surplus/(Deficit) Before Zone Change	Surplus/(Deficit) After Zone Change
LDR	406	369	363	(37)	(43)
MDR	179	92	92	(87)	(87)
HDR	62	7	13	(55)	(49)
Total	647	468	468	(179)	(179)

3. Conclusion

Our analysis shows that the City of Newberg's residential land supply is insufficient to meet the City's LDR, MDR or HDR needs over the next 15 years, the proposed 5.94-acre Martell Commons zone change notwithstanding. However, approval of the zone change would help address the most severe deficit as a percentage of overall need, the supply of HDR. Should the zone change be approved, the City's buildable residential land inventory would be able to accommodate approximately 89% of the need for LDR, 51% of the need for MDR and 21% of the need for HDR over the next 15 years.