

PLANNING COMMISSION STAFF REPORT
A RESOLUTION RECOMMENDING AMENDING THE NEWBERG COMPREHENSIVE PLAN, VIII. 2017 WATER MASTER PLAN INCORPORATING THE ADDENDUM WATER SUPPLY PLANNING 2023 INTO THE NEWBERG COMPREHENSIVE PLAN

FILE NO: CPTA22-0001

REQUEST: A Resolution recommending City Council amend the 2017 Water Master Plan incorporating the Addendum Water Supply Planning 2023 into the Newberg Comprehensive Plan

APPLICANT: City of Newberg, initiated by City Council Resolution No. 2022-3845

HEARING DATE: March 9, 2023

ATTACHMENTS:

Resolution No. 2023-384 with:

- Exhibit "A": 2017 Water Master Plan – Addendum Water Supply Planning 2023
- Exhibit "B": Findings including Attachment 1 Newberg Urban Area Growth Management Agreement 1979 (as amended) and Attachment 2 Five Year Multi-Funded & Water Capital Improvement Plan
- Exhibit "C": Comprehensive Plan Text Amendment

1. City Council Resolution No. 2022-3845 Initiating the Comprehensive Plan Text Amendment
2. Staff/Agency Comments
3. Public Comments

A. SUMMARY:

The proposed amendment does the following:

Adds the Addendum Water Supply Planning 2023 into the Newberg Comprehensive Plan as Appendix F.

The Addendum updates two sections of the Water Master Plan

- 4.0 Water Supply Analysis
- 7.0 Recommendations and Capital Improvement Program (CIP)

The Addendum focuses on two activities.

1. Redundant Water Supply – Creating a system to draw water from the Willamette River on the north side will provide the City with a safe and reliable water future.

2. Groundwater Treatment Plant – Building a modern, seismically resilient groundwater treatment plant will cost similar to required upgrades of the existing treatment plant.

This Addendum is not intended to meet all State requirements for a WMP update; it is primarily to document updates to the CIP.

B. BACKGROUND:

Conson are the consultants who worked with city staff on preparing the Water Master Plan addendum.

Oregon Administrative Rule (OAR) Chapter 660, Division 11 (660-011-0000) includes language in the Purpose Statement that a city or county must develop and adopt a public facility plan for areas within an Urban Growth Boundary. It further indicates that a plan is to assure that urban development is guided and supported by types and levels of urban facilities and services appropriate for the needs. OAR 660-011-0005 has a definition of Public Facilities Plan that includes water and its associated subsets of (A) Sources of water; (B) Treatment system; (C) Storage system; (D) Pumping system; and (E) Primary distribution system.

The 2017 Water Master Plan was prepared under a 20-year horizon (2015 – 2035) and is updated approximately every 5-10 years. The Addendum Water Supply Planning 2023 has adjusted the horizon to 2023 - 2043 and captured projects that have been completed and removed them from the CIP list.

The Newberg City Council initiated the Comprehensive Plan Text Amendment on August 15, 2022, by adoption of Resolution No. 2022-3845 (Attachment 1).

Oregon Revised Statutes and Oregon Administrative Rules govern the preparation of and amendments to Public Facilities plans. Specifically, Oregon Statewide Planning Goal 11 Public Facilities and Services, ORS 197.712(2)(e), Oregon Administrative Rules Chapter 660 Division 11 Public Facilities Planning are the applicable Statute, goals and rules.

For water system plans the following are applicable provisions to be included:

OAR 660-011-0005(7) "Public Facility Systems"

(a) Water:

(A) Sources of water;

(B) Treatment system;

(C) Storage system;

(D) Pumping system;

(E) Primary distribution system.

The 2017 Water Master Plan is broken into the following sections:

1. Introductions and Existing Water System
2. Water Requirements
3. Planning and Analysis Criteria
4. Water Supply Analysis
5. Water System Analysis
6. Operations and Maintenance
7. Recommendations and Capital Improvement Program
8. Figures
9. Tables
10. Appendices

The plan is based on a 20-year horizon of 2015 to 2035.

The Addendum Water Supply Planning 2023 is broken into the following sections:

- Introduction and Purpose
- Water Master Plan Background
- Redundant Water Supply Project Background
- Groundwater Treatment Plant Background
- Plan for a Safe & Reliable Water Future
- Capital Improvement Program (CIP) Update

The City conducted an online survey from October 26, 2022 to November 25, 2022. There were 81 visits to the web site.

- Home Page Pageviews: 86
- Home Page Unique Pageviews: 76

C. PROCESS: A comprehensive plan amendment is a Type IV application and follows the procedures in Newberg Municipal Code 15.100.060. The Planning Commission will hold a legislative public hearing on the application. The Commission will make a recommendation to the Newberg City Council. Following the Planning Commission's recommendation, the Newberg City Council will hold a legislative public hearing to consider the matter. Important dates related to this application are as follows:

- 8/15/22: The Newberg City Council adopted Resolution 2022-3845 initiating the Development Code amendment (Attachment 1).
- 2/22/23: Planning staff placed notice on Newberg's website and posted notice in four public buildings. *The Newberg Graphic* published notice of the hearing.
- 3/9/23: The Planning Commission held a public hearing, took public testimony, and deliberated on the proposal.

D. STAFF/AGENCY COMMENTS: As of the writing of this report, the City has received the following comments on the proposal (Attachment 2).

E. PUBLIC COMMENTS: As of the writing of this report, the city has received no written comments on the application. If the city receives written comments by the comment deadline, Planning staff will forward them to the Planning Commission.

F. DISCUSSION:

Executive Summary

The addendum focuses on two aspects:

1. Redundant Water Supply – Creating a system to draw water from the Willamette River on the north side will provide the City with a safe and reliable water future.
2. Groundwater Treatment Plant – Building a modern, seismically resilient groundwater treatment plant will cost similar to required upgrades of the existing treatment plant.

No changes to System Development Charges (SDCs) are proposed at this time. City Council discussion on SDCs will be completed before addressing any potential changes to SDCs.

For the full text of the Comprehensive Plan amendment, see Exhibit “A” Addendum to Resolution No. 2023-384.

This Addendum is not intended to meet all State requirements for a Water Master Plan update, it is primarily to document updates to the CIP. The goal of the Addendum is to assist the City in planning for adequate water infrastructure to comply with Oregon Health Authority (OHA) treatment regulations, incorporate seismic resilience considerations, and build a redundant water supply to meet the City’s long-term needs to provide a resilient water future for the community.

PRELIMINARY STAFF RECOMMENDATION:

The preliminary staff recommendation is made in the absence of public hearing testimony and may be modified subsequent to the close of the public hearing. Staff recommends that the Planning Commission does the following:

- 1. Consider the staff report, public testimony, and the findings.*
- 2. Deliberate.*
- 3. Make a motion to adopt Resolution No. 2023-384, which recommends that City Council adopt the 2017 Water Master Plan – Addendum Water Supply Planning 2023 into the Newberg Comprehensive Plan.*



PLANNING COMMISSION RESOLUTION 2023-384

A RESOLUTION RECOMENDING AMENDING THE NEWBERG COMPREHENISVE PLAN, VIII. 2017 WATER MASTER PLAN INCORPORATING THE ADDENDUM WATER SUPPLY PLANNING 2023 INTO THE NEWBERG COMPREHENSIVE PLAN

RECITALS

1. The Newberg City Council initiated the Comprehensive Plan Amendment by Resolution No. 2022-3845.
2. The City of Newberg adopted its Water Master Plan by Ordinance No. 2017-2816.
3. The City of Newberg last updated its Water Master Plan in May 2021 for the Riverfront Master Plan by Ordinance No. 2021-2876.
4. The 2017 Water Master Plan – Addendum Water Supply Planning 2023 was prepared in accordance with Oregon Statewide Planning Goal 11 - Public Facilities and Services, ORS 197.712(2)(e), and Oregon Administrative Rules Chapter 660 Division 11 Public Facilities Planning.
5. Oregon Administrative Rules Chapter 660 Division 11 Public Facilities Planning requires that a Water Master Plan be a part of a Comprehensive Plan
6. The 2017 Water Master Plan – Addendum Water Supply Planning 2023 conducted an online open house in November and December 2002 to gain public feedback.
7. After proper notice, the Newberg Planning Commission opened the hearing on March 9, 2023, considered public testimony and deliberated. They found that the proposed amendment was in the best interests of the City.

The Newberg Planning Commission resolves as follows:

1. The Planning Commission of the City of Newberg recommends the City Council incorporate the 2017 Water Master Plan – Addendum Water Supply Planning 2023 into the Newberg Comprehensive Plan.
2. This recommendation is based on the staff report, Exhibit “A” 2017 Water Master Plan – Addendum Water Supply Planning 2023, the Findings in Exhibit “B”, and Comprehensive Plan text language in Exhibit ”C”.

3. Exhibits “A”, “B”, and “C” are incorporated by reference.

Adopted by the Newberg Planning Commission this 9th day of March 2023.

ATTEST:

Planning Commission Chair

Planning Commission Secretary

List of Exhibits:

- Exhibit “A”: 2017 Water Master Plan – Addendum Water Supply Planning 2023
- Exhibit “B”: Findings including Attachment 1 Newberg Urban Area Growth Management Agreement 1979 (as amended) and Attachment 2 Five Year Multi-Funded & Water Capital Improvement Plan
- Exhibit “C”: Comprehensive Plan Text Amendment

**Exhibit “A” to Planning Commission Resolution No. 2023-384
Water Master Plan 2017 – Addendum Water Supply Planning 2023
File CPTA22-0001**



Water Master Plan



City of Newberg, Oregon
May 2017



Addendum - Riverfront Master Plan
May 2021

Addendum - Water Supply Planning
April 2022

WATER MASTER PLAN

FOR

CITY OF NEWBERG

MAY 2017



RENEWS 6-30-17



RENEWS 6-30-18

**Addendum - Riverfront Master Plan
May 2021**

**Murraysmith
888 SW 5th Ave, Suite 1170
Portland, OR 97204
503.225.9010**

TABLE OF CONTENTS

1. INTRODUCTION AND EXISTING WATER SYSTEM	Page
Introduction	1-1
Water System Background	1-1
Springs Water System.....	1-2
Water Service Area	1-2
Supply Facilities	1-2
Well Field	1-2
Raw Water Transmission.....	1-3
Water Treatment Plant.....	1-4
Pressure Zones.....	1-4
Storage Reservoirs.....	1-5
North Valley Reservoirs	1-5
Corral Creek Reservoir	1-5
Booster Pump Stations	1-6
Distribution System.....	1-6
Metering.....	1-7
Non-potable Reuse System	1-7
SCADA System.....	1-7
2. WATER REQUIREMENTS	
Planning Period	2-1
Service Area	2-1
Existing	2-1
Future.....	2-1
Historical Population.....	2-1
Historical Water Demand.....	2-2
Water Demand by Pressure Zone	2-3
Water Consumption by Customer Type	2-3
Future Population and Water Demand Forecast.....	2-4
Future Demand by Pressure Zone.....	2-5
3. PLANNING AND ANALYSIS CRITERIA	
Water Supply Capacity.....	3-1
Normal Operating Supply	3-1
Redundant Supply.....	3-2
Distribution System Capacity and Service Pressures.....	3-2
Pressure Zone Configuration	3-2
Normal Service Pressure.....	3-3
Service Pressure in an Emergency.....	3-3
Distribution Main Criteria	3-3
Water Quality	3-3

Source Water.....	3-3
Distribution System	3-4
Storage Volume.....	3-5
Operational Storage	3-5
Fire Storage.....	3-5
Emergency Storage	3-5
Pump Station Capacity	3-6
Pump Station Supplying Pressure Zone with Gravity Storage	3-6
Pump Station Supplying Constant Pressure to Zone	3-6
Standby Power	3-6
Fire Flow Recommendations.....	3-6
Summary	3-8

4. WATER SUPPLY ANALYSIS

Existing Supply Assessment	4-1
Existing Groundwater Wells.....	4-1
Current Source Capacity Estimates	4-3
Water Rights Summary.....	4-4
Transmission.....	4-8
Treatment.....	4-8
Future Supply	4-8
Required Capacity.....	4-9
Groundwater Source Expansion Assessment.....	4-9
Hydrogeology	4-9
Water Rights	4-10
Aquifer Storage and Recovery (ASR)	4-10
Source Expansion Alternatives.....	4-10
Source Conclusion	4-14
Transmission and Treatment for Redundant Supply	4-15
Redundant Supply Estimated Costs	4-15

5. WATER SYSTEM ANALYSIS

Pressure Zone Analysis	5-1
Existing Pressure Zones.....	5-1
Proposed Future Pressure Zones.....	5-2
Storage Capacity Analysis.....	5-3
Existing Storage Capacity Findings.....	5-3
Proposed Bell Road Reservoir	5-3
Pumping Capacity Analysis	5-6
Existing Pumping Capacity Findings	5-8
Proposed Pump Stations	5-8
Back-Up Power.....	5-9
Distribution Capacity and Hydraulic Performance	5-10
Hydraulic Model.....	5-10

Modeled Water Demands	5-10
Model Calibration	5-10
Fire Flow Analysis.....	5-11
Peak Hour Demand Analysis.....	5-12
Distribution System Water Quality	5-12
Total Coliform Rule Compliance	5-12
Lead and Copper Rule Compliance	5-12
Stage 2 Disinfectants and Disinfection Byproducts Rule (D/DBPR) Compliance	5-12
Summary	5-13

6. OPERATIONS AND MAINTENANCE

Existing O&M Structure	6-1
O&M Regulations and Guidelines	6-2
Operator Certification.....	6-3
Current O&M Practices and Procedures	6-4
System Operation.....	6-4
System Preventive Maintenance.....	6-4
Record Keeping	6-5
Customer Complaints	6-5
Conclusions & Recommendations	6-6
Distribution System	6-6
Water Storage Tanks.....	6-7
Staffing.....	6-7

7. RECOMMENDATIONS AND CAPITAL IMPROVEMENT PROGRAM (CIP)

Cost Estimating Data.....	7-1
Water System Capital Improvement Program.....	7-1
CIP Cost Allocation to Growth.....	7-2
Supply	7-2
Redundant Supply.....	7-2
Treatment.....	7-2
Storage Reservoir	7-3
Pump Stations.....	7-3
Distribution Mains.....	7-4
Distribution Main Cost Estimates.....	7-4
Distribution Main Improvements for Fire Flow	7-4
Projects for Future System Expansion.....	7-6
Routine Main Replacement Program.....	7-8
Planning Studies and Facility Assessments.....	7-9
Other.....	7-9
Non-potable Distribution System	7-9
Public Works Maintenance Facility Improvements.....	7-10
CIP Funding	7-10

Water Rates.....	7-10
System Development Charges (SDCs).....	7-11
Summary	7-14

FIGURES

1-1 Water Service Area Map.....	1-8
1-2 Existing Water System Schematic	1-9
2-1 Current Annual Water Consumption by Customer Type	2-4
6-1 Water Utility Public Works Staff FTE	6-2
7-1 Pipe Replacement Program.....	7-16
7-2 Overview of SDC Methodology	7-12

TABLES

1-1 Well Capacity Summary	1-3
1-2 WTP High Service Pump Summary	1-4
1-3 Reservoir Summary	1-5
1-4 Distribution System Pipe Summary.....	1-6
2-1 Historical Water Demand Summary	2-3
2-2 Current Water Demand by Pressure Zone	2-3
2-3 Future Water Demand Summary	2-5
2-4 Future Water Demand by Pressure Zone	2-6
2-5 North Hills URA Future Water Demand	2-7
3-1 Summary of Recommended Fire Flows	3-7
4-1 Source Capacity Estimates.....	4-4
4-2 City of Newberg Water Rights for Use of Groundwater	4-6
4-3 Allocation of Water Right Capacity - Groundwater	4-7
4-4 Redundant Supply Cost Estimate Summary	4-16
5-1 Storage Capacity Analysis	5-5
5-2 Pumping Capacity Analysis.....	5-7
5-3 Calibration Confidence	5-11
6-1 Certification Status of Personnel	6-3
7-1 Unit Cost for Water Main Projects	7-4
7-2 Distribution Main Improvements for Fire Flow	7-5
7-3 Distribution Main Improvements for System Expansion	7-7
7-4 20-Year Distribution Main Replacement Cost Summary	7-8
7-5 Proposed Capital Improvement Program (CIP) Summary	7-15

APPENDICES

- Appendix A: Plates 1 Proposed Water System Map
- Appendix B: Newberg Recycled Water Use Evaluation
- Appendix C: Source Expansion Assessment
- Appendix D: Water SDC Methodology
- Appendix E: Addendum - Riverfront Master Plan

Appendix F: Addendum - Water Supply Planning



SECTION 1

SECTION 1 INTRODUCTION AND EXISTING WATER SYSTEM

Introduction

The purpose of this Water Master Plan (WMP) is to perform an analysis of the City of Newberg's (City's) water system and:

- Document existing water system service area, facilities and operation
- Estimate future water requirements including potential water system expansion areas
- Identify deficiencies and recommend water facility improvements that correct deficiencies and provide for growth
- Update the City's capital improvement program (CIP)
- Evaluate the City's existing operation and maintenance (O&M) program
- Evaluate the City's existing system development charges (SDCs)

In order to identify system deficiencies, existing water infrastructure inventoried in this section will be assessed based on estimated existing and future water needs developed in **Section 2** and water system performance criteria described in **Section 3**. The results of this analysis are presented in **Sections 4 and 5**. **Section 7** identifies improvement projects to mitigate existing and projected future deficiencies and provide for system expansion including a prioritized CIP and a discussion of CIP funding including an updated SDC methodology. **Section 6** presents the O & M evaluation. The planning and analysis efforts presented in this WMP are intended to provide the City with the information needed to inform long-term water infrastructure decisions.

This plan complies with water system master planning requirements established under Oregon Administrative Rules (OAR) for Public Water Systems, Chapter 333, Division 61.

Water System Background

The City owns and operates a public water system that supplies potable water to all residents, businesses and public institutions within the city limits. This section describes the water service area and inventories the City's water system facilities including existing supply sources, pressure zones, finished-water storage reservoirs, pump stations and distribution system piping.

Plate 1 in Appendix A illustrates the City's water system service area limits, water system facilities and distribution system piping. The water system schematic in **Figure 1-2** at the end of this section shows the existing configuration of water system facilities and pressure zones.

Springs Water System

Historically Newberg maintained four natural spring sources north of the city center which were part of the City's original water system at the start of the 20th century. Following the development of the City's well field, the springs were disconnected from the City distribution system and used to supply only the "springs" or "riparian" customers nearby. Almost all of these springs customers are outside of the city limits and urban growth boundary (UGB).

In 2015, the City divested from the Springs Water System. Ownership, operation and maintenance of springs sources, including Snider, Skelton, Atkinson and Oliver Springs as well as treatment, piping, water rights and easements were transferred to the Chehalem Spring's Water Association, established by the property owners who receive water from the springs for the purpose of operating the springs system. The City retains ownership of parcels where the springs are located which are leased to the Chehalem Spring's Water Association. Analysis of springs system sources, facilities and service areas are not included in this Master Plan.

Water Service Area

The City's current water service area includes all properties within the city limits as well as a small number of customers outside the city limits and a number of independent water districts outside the city. Current customers outside the city limits include; residents of Aspen Estates along Highway 240 west of Chehalem Creek, properties along Highway 99W east of Providence Hospital including the Rex Hill Winery. Private water systems supplied by the City of Newberg include; Chehalem Terrace Water Company, Chehalem Valley Water Association, Northwest Newberg Water Association, Sam Whitney Water District, Sunny Acres Water District and West Sheridan Street Water Association. Portions of these private water systems are within the UGB and Urban Reserve Areas (URAs).

The future service area and the study area for this Master Plan includes all areas within the city limits and UGB. All customers of existing small water districts supplied by the City are also included in the Master Plan analysis. Newberg's municipal code prohibits City water service to new customers in private water systems outside the City. The existing and future service area boundaries are illustrated on **Figure 1-1** at the end of this section.

Supply Facilities

Well Field

The City draws its water supply from a well field located in Marion County farmland across the Willamette River from the City's Water Treatment Plant (WTP). The well field includes nine existing wells, five of which are currently active. Due to declining yields Well Nos. 1, 2 and 3 have been taken out of service. A ninth well was recently completed. Due to the close proximity of wells in the City's well field, nominal well capacities may be impacted by the

number and combination of wells in operation at the same time. Wells are operated by City staff in combinations which best meet the anticipated system demands for the day. All active wells, except Well 9, are equipped with variable frequency drives (VFDs) which adjust pump speed and well production based on the water level at the City’s finished water storage reservoirs. Active City well capacities in gallons per minute (gpm) are summarized in **Table 1-1**.

The well field lies within the Willamette River floodplain and was entirely submerged during the 1996 flood. Well 8 was constructed with mooring piles incorporated into the well house design to allow City staff to dock a boat at the well if needed in case of a flood. Well 8 is also the only existing City well with a transfer switch to allow well operation by a portable generator.

**Table 1-1
Well Capacity Summary**

Well	Year Constructed	Nominal Capacity (gpm)	
		Min	Max
4	1970	350	400
5	1980	400	425
6	1980	900	1,600
7	2001	1,000	1,700
8	2007 (pump upsized 2014)	1,700	2,300
9	2016	1,800	1,800
TOTAL	gpm	6,150	8,225
	mgd	8.9	11.8

Raw Water Transmission

Water is supplied from the well field to the WTP on the north side of the Willamette River through two large-diameter raw water transmission mains. The first main is a 1,900 foot long, 24-inch diameter cast iron main suspended from a decommissioned highway bridge. The 24-inch main has an approximate capacity of 10 million gallons per day (mgd) (7,000 gpm). The approaches to the former Highway 219 bridge have been demolished and the bridge is now owned and maintained by the City for the sole purpose of carrying the 24-inch water transmission main from the well field to the WTP. A second 30-inch diameter high density polyethylene (HDPE) transmission main, constructed downstream in 2006, carries water from the well field under the Willamette River to the WTP.

Water Treatment Plant

See Note 2

The City's WTP, constructed in 1953, is located on the north bank of the Willamette River south of downtown Newberg within the fence of the WestRock mill. The WTP was expanded and upgraded in 1961, 1970, 1980, 1997 and 2006. The current WTP is a conventional filtration facility used to treat high levels of dissolved iron in the well source water. The plant has a nominal capacity of 9 mgd. According to City staff, operational capacity at the WTP is limited to approximately 8 mgd due to undersized piping between the raw water transmission mains and the settling basins.

The City's distribution system and finished water storage reservoirs are supplied by four High Service Pumps which draw suction supply from the WTP clearwell. All four line shaft vertical turbine pumps are equipped with VFDs which adjust the pumping rate based on the clearwell water level. The four pumps have a total rated capacity of approximately 14.3 mgd. WTP High Service pumps and capacities are summarized in **Table 1-2**.

Table 1-2
WTP High Service Pump Summary

Pump No.	Install Year	Motor Hp	Manufacturer	Model	Capacity	
					gpm	mgd
1	2005	250	Flowserve	15EHM 3 Stage Vertical Turbine	2,800	4.0
2	2005	250	Flowserve	15EHM 3 Stage Vertical Turbine	2,800	4.0
3	1980	150	Byron Jackson	12MQH 5 Stage Vertical Turbine	1,300	1.9
4	2005	250	Flowserve	15EHM 3 Stage Vertical Turbine	2,800	4.0
TOTAL					9,700	13.9

Pressure Zones

The majority of Newberg's existing water customers are served from Pressure Zone 1 which is supplied by gravity from the City's three finished water storage reservoirs and from the WTP.

Residential customers along Knoll Drive north of Hillsdale Drive which are too high in elevation to receive adequate service pressure from Zone 1 are supplied constant pressure from the Oak Knoll Pump Station at an approximate hydraulic grade line (HGL) of 470 feet. For the purposes of this WMP, this area is referred to as Pressure Zone 2.

Storage Reservoirs

Newberg's water system has three reservoirs with a total combined storage capacity of approximately 12 million gallons (MG). All three reservoirs have an approximate overflow elevation of 403 feet. **Table 1-3** presents a summary of the City's existing storage reservoirs.

North Valley Reservoirs

North Valley Reservoir Nos. 1 and 2 are located outside of the UGB on the north side of North Valley Road west of Highway 219. The reservoirs share a single site which is fully fenced. Reservoir No. 1 is a 4 MG circular, hopper-bottom concrete tank with a domed roof constructed in approximately 1960. Reservoir No. 2 is a 4 MG, circular, prestressed concrete reservoir constructed around 1978.

Reservoir No. 2 is currently being seismically upgraded. Mixing systems are being added to both tanks to mitigate water age issues. Interior coating of both Reservoir No. 1 and 2 was also completed as part of the upgrade project.

Corral Creek Reservoir

The Corral Creek Reservoir is a 4-MG, circular, prestressed concrete reservoir constructed in 2003 on the eastside of the City's water system. This reservoir is equipped with an altitude valve.

Table 1-3
Reservoir Summary

Reservoir Name	Capacity (MG)	Overflow Elevation² (ft)	Floor Elevation² (ft)	Diameter (ft)	Type	Year Built
North Valley No. 1	4.0	402.60	376.71 (369) ¹	144	Concrete	1960
North Valley No. 2	4.0	402.69	372	151	Prestressed Concrete	1977
Corral Creek	4.0	402.5	368.85	138	Prestressed Concrete	2003

Note: 1. North Valley Reservoir No. 1 parentheses indicate floor elevation of hopper bottom.

2. Vertical datum is NGVD 1929.

Booster Pump Stations

The Oak Knoll Pump Station is the only booster pump station in the Newberg distribution system. Oak Knoll was installed in 2000 to provide constant pressure service to around 40 homes along Knoll Drive north of Hillsdale Drive at the northern edge of the existing water service area. Located at 3613 Ivy Drive, the package pump station houses three pumps with a total capacity of 1,260 gpm. The station includes low flow and peak demand pumps with approximate capacities of 10 gpm and 250 gpm respectively and one high capacity pump dedicated to providing fire flow at approximately 1,000 gpm. This station includes backup power generation which allows the station to function during temporary power losses, ensuring that adequate service pressures are maintained.

Distribution System

The City's finished water distribution system is composed of various pipe materials in sizes up to 24 inches in diameter. The total length of City-owned potable piping in the service area is approximately 56.4 miles. The City maintains significant lengths of pipes 2-inches in diameter and smaller. Pipe materials under 4-inch diameter are primarily copper, polyvinyl chloride (PVC) and galvanized steel. Larger diameter pipe materials are a mix of cast iron and ductile iron with approximately 80 feet of steel main where the distribution system crosses Highway 219. **Table 1-4** presents a summary of pipe lengths by diameter from the City's Geographic Information Systems (GIS) water utility mapping.

Table 1-4
Distribution System Pipe Summary

Pipe Diameter	Approximate Length (miles)
4-inch or less	5.3
6-inch	13.2
8-inch	23.3
10-inch	4.3
12-inch	6.0
14-inch	0.2
16-inch	0.5
18-inch	2.7
24-inch	0.9
Total Length	56.4

Metering

All customer water use is currently metered using advanced metering infrastructure (AMI). Meters at individual services transmit consumption readings which are collected monthly using a “drive-by” receiving antenna.

Non-potable Reuse System

In addition to potable water distribution, Newberg also maintains a non-potable “purple pipe” distribution system. Non-potable systems are generally intended for irrigation use or to provide process and cooling water for manufacturing applications where potable water quality is not required.

The Newberg non-potable system can be supplied from either the City’s Otis Springs source or reuse water from the Newberg Wastewater Treatment Plant (WWTP) effluent. Otis Springs is located east of the City on the north side of Highway 99W. It produces approximately 300 gpm which is pumped through a 10-inch diameter non-potable main along Highway 99W southwest to a pond at the Chehalem Glenn Golf Course. Otis Springs’ pumps operate based on the water level at the golf course pond and production is metered at both the springs and golf course.

Installed in 2008, a pressurized membrane filtration system provides approximately 350,000 gallons per day of treated WWTP effluent (reuse water) to the golf course irrigation system. Reuse water is supplied from the south end of the course through 10-inch diameter reuse piping and meter installed along Wilsonville Road.

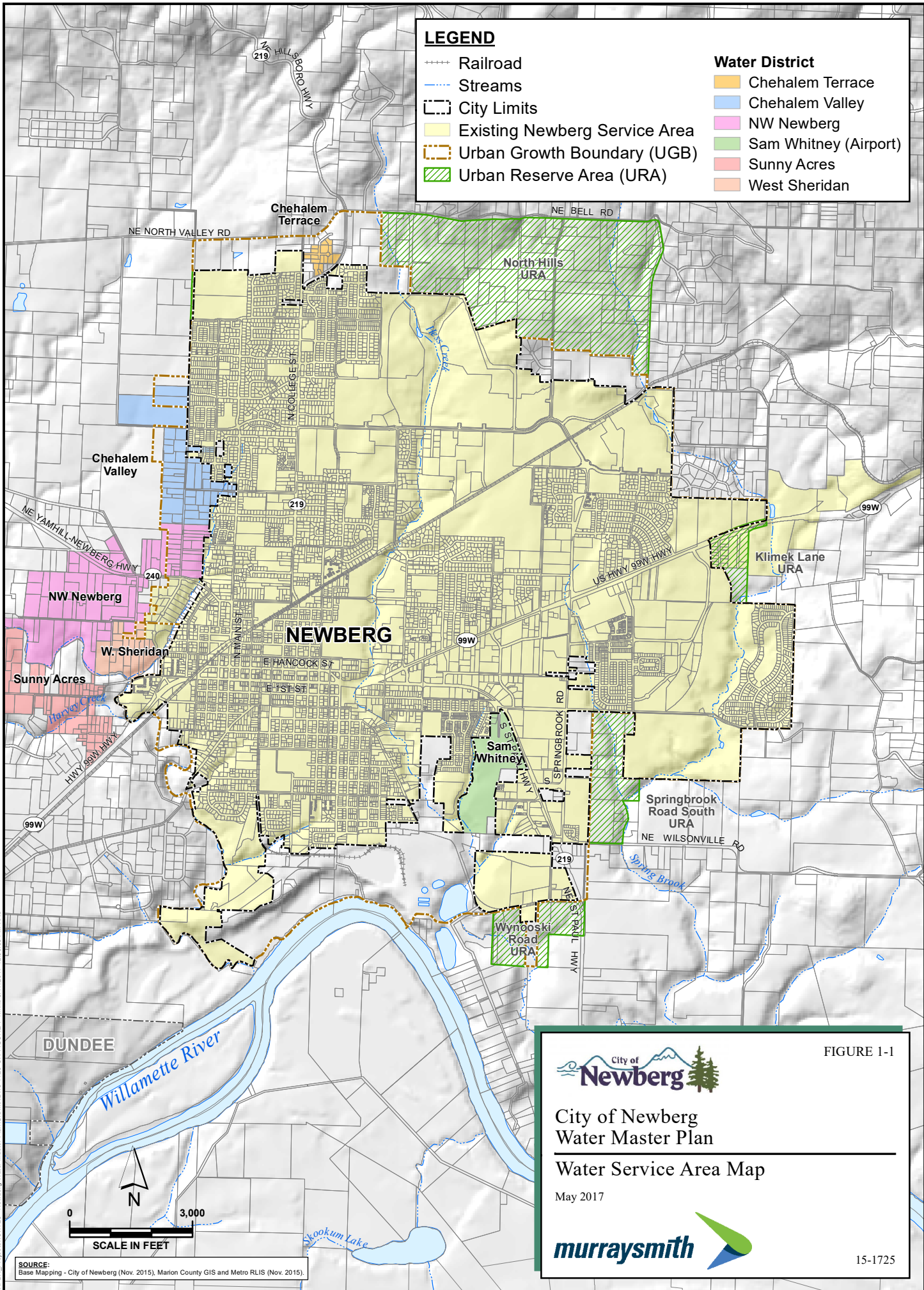
The publicly-owned golf course is the only existing customer of the City’s reuse system. Reuse pipes have been installed in parallel with other infrastructure and road projects at various locations within the Newberg water service area. However, the majority these non-potable mains are isolated pending future opportunities to connect and expand the reuse system. Evaluation of the City’s non-potable reuse system and an analysis of potential customers and future expansion is documented in **Appendix B**.

SCADA System

Newberg’s Supervisory Control and Data Acquisition (SCADA) system is used for remote operation of distribution system components as well as system performance monitoring and recording. Remote telemetry units (RTUs) at the well field, all reservoirs, the Oak Knoll Pump Station and Otis Springs transmit operating information and water levels to the WTP where City staff are able to view the status of the water system and make operational adjustments as required.

LEGEND

++++ Railroad	Water District
--- Streams	Chehalem Terrace
--- City Limits	Chehalem Valley
Existing Newberg Service Area	NW Newberg
Urban Growth Boundary (UGB)	Sam Whitney (Airport)
Urban Reserve Area (URA)	Sunny Acres
	West Sheridan



SOURCE:
Base Mapping - City of Newberg (Nov. 2015), Marion County GIS and Metro RLIS (Nov. 2015)

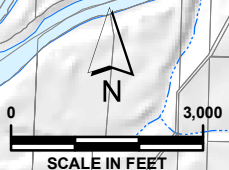




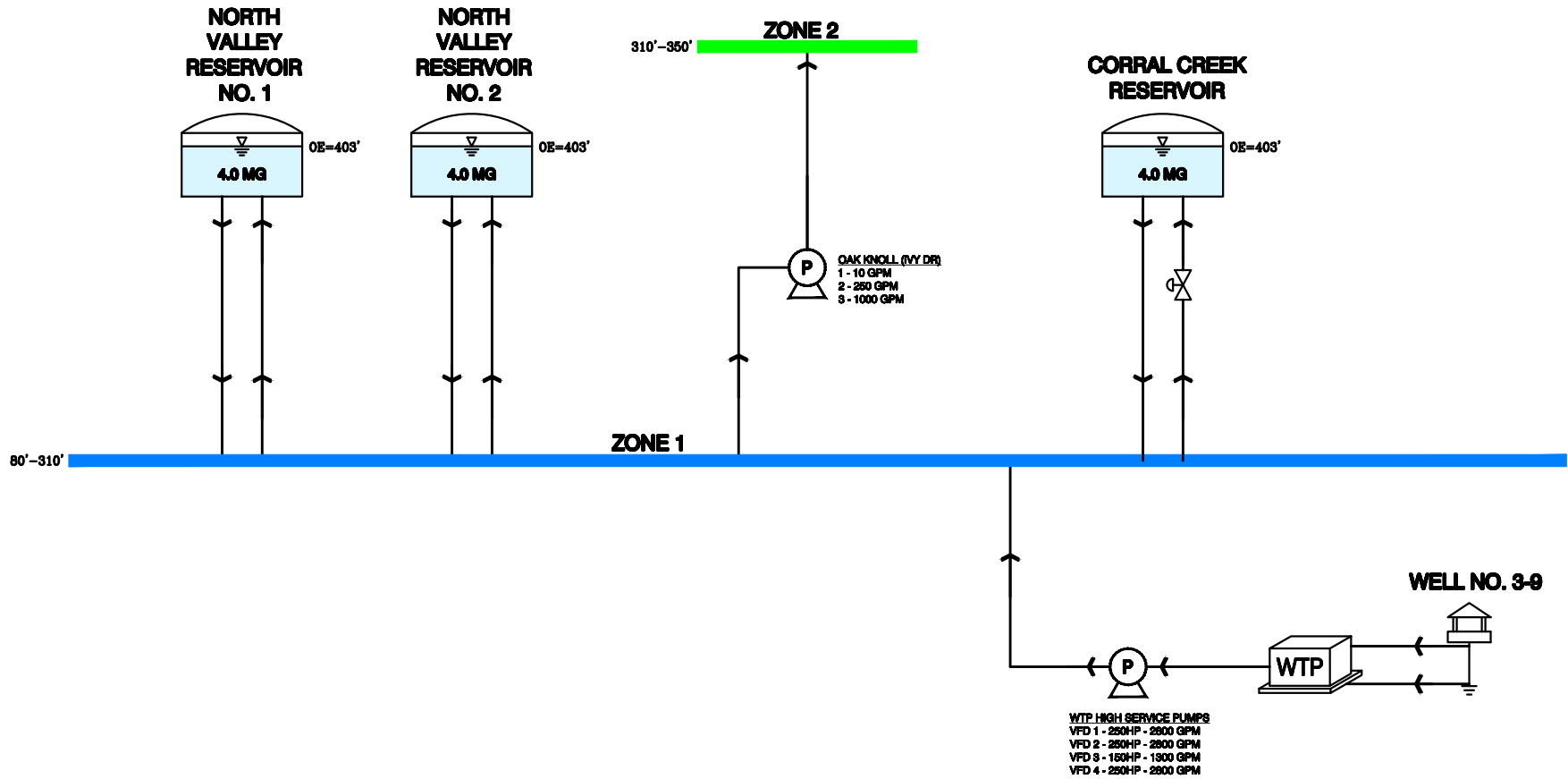
FIGURE 1-1


City of Newberg
 Water Master Plan
 Water Service Area Map
 May 2017



15-1725

G:\PDX_Projects\151725 - Newberg Water Master Plan\GIS\MXD\15-1725-OR-FIGURE 1-1.mxd 5/17/2017 12:59:08 PM HAS



LEGEND

WATER MAIN	
HIGHEST GROUND ELEVATION SERVED BY PRESSURE ZONE OR SUBZONE	
RESERVOIR	
ALTITUDE VALVE	
PUMP STATION	

ABBREVIATIONS

EL	ELEVATION
GPM	GALLONS PER MINUTE
HP	HORSEPOWER
MG	MILLION GALLONS
OE	OVERFLOW ELEVATION
PRV	PRESSURE REDUCING VALVE
PS	PUMP STATION
VFD	VARIABLE FREQUENCY (SPEED) DRIVE



FIGURE 1-2

CITY OF NEWBERG

EXISTING WATER SYSTEM SCHEMATIC

May 2017





SECTION 2

WATER REQUIREMENTS

This section presents existing and projected future water demands for the City of Newberg's (City's) water service area. Demand forecasts are developed from future population projections and historical water consumption and production records.

Planning Period

The planning period for this Water Master Plan (WMP) is 20 years, through the year 2035, consistent with Oregon Administrative Rule (OAR) requirements for Water System Master Plans (OAR 333-061).

Service Area

Existing

As presented in **Section 1 Figure 1-1**, the City's current water service area includes all properties within the city limits, a small number of customers outside the city limits and six independent water districts adjacent to the city limits. Private water systems supplied by the City of Newberg include: Chehalem Terrace Water Company, Chehalem Valley Water Association, Northwest Newberg Water Association, Sam Whitney Water District, Sunny Acres Water District and West Sheridan Street Water Association. Portions of these private water systems are within the City's Urban Growth Boundary (UGB) and Urban Reserve Areas (URAs).

Future

The future service area and the study area for this WMP includes all areas within the city limits and UGB. Analysis does not include all of the City's URAs as these are anticipated to develop outside of the 20-year planning horizon. A high level estimate of ultimate water demand in the City's North Hills URA is included in this section as this area's anticipated future growth impacts the sizing of a proposed storage reservoir. The proposed reservoir is discussed in more detail in **Section 5**.

Customers of existing water districts supplied by the City are also included in the WMP demand analysis. It is assumed that these Districts will continue to operate independent distribution systems. Newberg's municipal code prohibits City water service to new customers in private water systems outside the City thus no growth is anticipated for these Districts.

Historical Population

Newberg currently supplies water to approximately 22,900 residents. Current and historical population estimates for Newberg are taken from the Portland State University Population Research Center's (PSU PRC) *2012 Population Forecasts for Yamhill County, its Cities and*

Unincorporated Area 2011 to 2035. This report was adopted by Yamhill County and can be relied upon by the City for planning purposes per OAR 660-032-0040. Historical population estimates are summarized in **Table 2-1**.

Historical Water Demand

Water demand refers to all potable water required by the system including residential, commercial, industrial and institutional uses. The City of Newberg also maintains a non-potable water reuse system which is described in more detail in **Appendix B**. Potable water demands are described using three water use metrics, average daily demand (ADD), maximum day demand (MDD) and peak hour demand (PHD). Each of these metrics are stated in gallons per unit of time such as million gallons per day (mgd) and in gallons per capita per day (gpcd). ADD is the total annual water volume used system-wide divided by 365 days per year. MDD is the largest 24-hour water volume for a given year. In western Oregon, MDD usually occurs each year between July 1st and September 30th. PHD is estimated as the largest hour of demand on the maximum water use day.

Water demand can be calculated using either water consumption or water production data. Water consumption data is taken from the City's customer billing records and includes all revenue metered uses. Water production is measured as the water supplied to the distribution system from the City's Water Treatment Plant (WTP) plus the water volume supplied from distribution storage. Water production includes unaccounted-for water like water loss through minor leaks and unmetered, non-revenue uses, such as, hydrant flushing.

For the purposes of this WMP, water production data is used to calculate total water demand in order to account for all water uses including those which are not metered by the City. 2015 customer consumption and billing records are used to distribute current water demands throughout the water system hydraulic model, discussed in **Section 5**.

The historical ratios of ADD:MDD and MDD:PHD are used to estimate future maximum day and peak hour demands. Based on historical system-wide demands, the ratio of ADD:MDD is approximately 2.0. The ratio of MDD:PHD is approximately 1.7 consistent with similar regional water providers. **Table 2-1** summarizes the City's current system-wide water demand based on water production data.

Table 2-1
Historical Water Demand Summary
See Note 1

Year	Population	ADD		MDD	
		(mgd)	(gpcd)	(mgd)	(gpcd)
2010	22,110	2.23	101	4.84	219
2011	22,230	2.24	101	4.42	199
2012	22,300	2.27	102	4.76	213
2013	22,580	2.24	99	4.39	194
2014	22,765	2.31	101	4.43	194
2015	22,900	2.38	104	4.75	207

Water Demand by Pressure Zone

As described in Section 1, water systems are divided into pressure zones in order to provide adequate service pressure to customers at different elevations. Each pressure zone is served by specific facilities, such as, reservoirs or pump stations and related piping which supply pressure to customers. In order to assess the adequacy of these facilities, it is necessary to estimate demand in each pressure zone. The majority of Newberg water customers are part of Pressure Zone 1 served by gravity from the City’s WTP and three water storage reservoirs. Approximately 40 residential customers in Pressure Zone 2 are supplied constant pressure service from the Oak Knoll Pump Station. Current water demand is distributed between the City’s two pressure zones based on metered water consumption from 2015 billing records as summarized in **Table 2-2**.

Table 2-2
Current Water Demand by Pressure Zone

Pressure Zone	2015 ADD (mgd)
1	2.36
2	0.02
System-wide Total	2.38

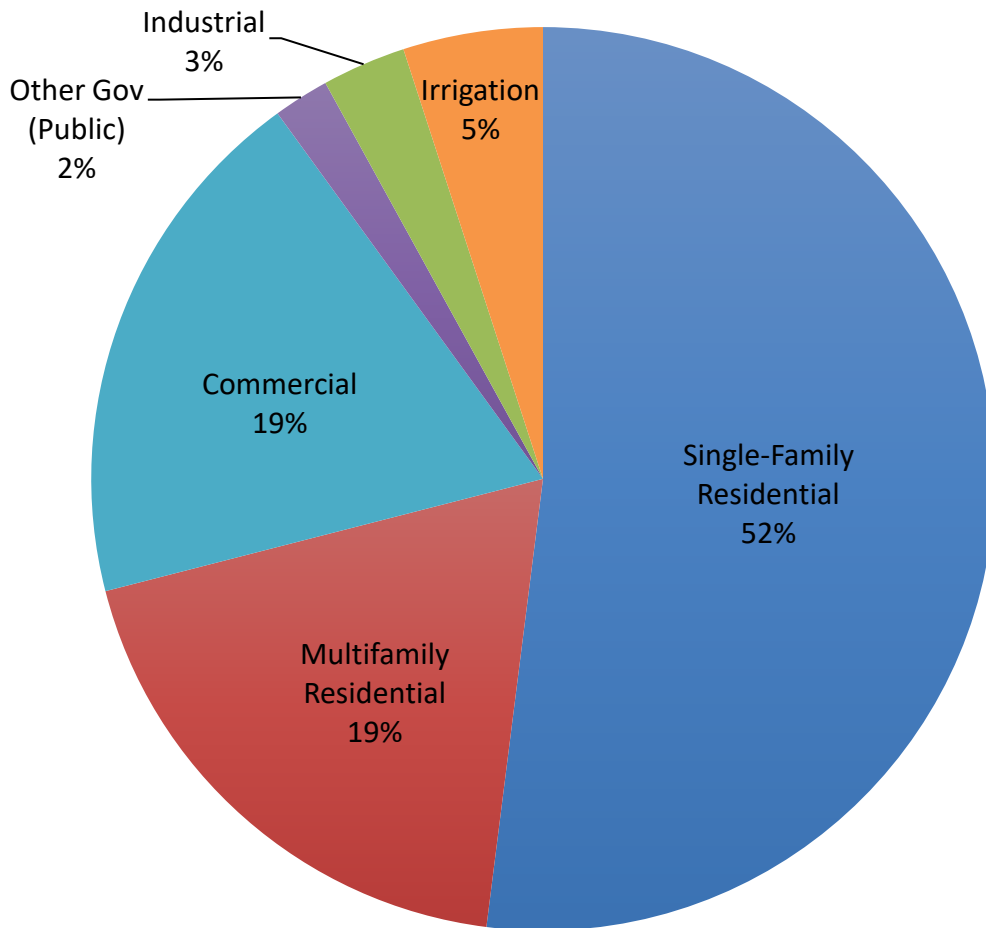
Water Consumption by Customer Type

The City’s water utility billing records maintain six primary customer types; Single-Family, Multifamily, Commercial, Industrial, Other Gov (Public) and Irrigation. The Other Gov customer type includes a wide variety of public facilities including schools, parks and community centers. Irrigation consumption includes irrigation services supplied from the City’s drinking water system and does not include irrigation water provided by the non-potable reuse system which is discussed in **Appendix B**. A seventh customer type, “Outside” includes all services outside the current city limits. Based on their meter size, the water demand of these Outside services are assumed to

correlate with the City’s Single-Family (3/4- and 1-inch meters) and Commercial (2-inch and larger meters) customer types.

Percentages of current water consumption by customer type are calculated based on 2015 City water billing records. As illustrated on **Figure 2-1**, the majority of water consumption in Newberg, approximately 71 percent, is by residential customers.

Figure 2-1
Current Annual Water Consumption by Customer Type



Future Population and Water Demand Forecast

Estimates of future growth and related water demand within the Newberg UGB are developed using the best available information for the City’s service area including adopted population forecasts from the PSU PRC’s *2012 Population Forecasts for Yamhill County, its Cities and Unincorporated Areas 2011 to 2035* report and historical per capita water demands presented in **Table 2-1**. Future system-wide water demands are forecast at 5-, 10- and 20-years.

Historical per capita average daily water demands (ADD) range from 99 to 104 gpcd. An average per capita demand of 101 gpcd is used to forecast ADD based on population projections. Based on 2010 US Census data the average number of persons per household in Newberg is approximately 2.66.

Future MDD is projected from estimated future ADD based on the current average ratio of MDD:ADD, also referred to as a peaking factor. From current water demand data shown in **Table 2-1**, the MDD:ADD peaking factor for the Newberg system is approximately 2.0. Future PHD is similarly projected from future MDD, the PHD:MDD peaking factor is approximately 1.7. Forecasted water demands are summarized in **Table 2-3**.

Table 2-3
Future Water Demand Summary
See Note 1

Year	Forecast Population	ADD (mgd)	MDD (mgd)	PHD (mgd)
2020	28,250	2.86	5.72	9.72
2025	32,213	3.26	6.52	11.08
2035	38,490	3.89	7.78	13.23

Future Demand by Pressure Zone

Forecasted future water demands are allocated to existing and proposed future pressure zones based on an ideal service pressure range of 40 to 80 pounds per square inch (psi) and existing ground elevations in potential water service expansion areas within the UGB and North Hills URA. Existing and proposed pressure zone boundaries for the study area are illustrated on **Plate 1** in **Appendix A**. Estimated future water demands by pressure zone are summarized in **Table 2-4**.

The City’s existing Pressure Zone 1 provides service up to approximately 310 feet elevation. As properties within the UGB and above Zone 1 service elevations begin to develop, a higher-elevation Pressure Zone 3 will be required northeast of the city center. For the purposes of this WMP, it is assumed that the proposed Zone 3 would serve customers between 310 and 440 feet elevation ultimately including most of the North Hills URA. Properties in the North Hills URA above 440 feet are assumed to be served from a future Zone 4 which is not analyzed for the purposes of this Master Plan. The City has purchased property north of Bell Road near the intersection with Zimri Drive as a future storage reservoir site to serve higher-elevation development within the UGB and North Hills URA.

It is assumed that Zone 2 customers will continue to be served by constant pressure through the 20-year planning horizon. Beyond the 20-year planning horizon, Zone 2 customers may ultimately be served by gravity from the proposed Bell Road Reservoir, as development warrants.

Proposed Zone 2 Demand

The City anticipates demands in Zone 2 to expand by approximately 171 gallons per minute (gpm) (0.25 mgd) with the addition of the existing North Valley Friends Church, the proposed Veritas School and a proposed 11-lot single-family subdivision at 4016 N College Street (Rourke Property). Additional Zone 2 demand is taken from analysis presented by AKS Engineering & Forestry (December 2015) in support of the Rourke Property subdivision. Completion of these additional Zone 2 customer connections is assumed to occur within the next 5 years.

Proposed Zone 3 Demand

As shown on **Plate 1** in **Appendix A**, within the 20-year planning horizon, the proposed Zone 3 would supply a small portion of the Springbrook development along Aspen Way within the current city limits and UGB. Ultimately, proposed Zone 3 would serve most future customers in the North Hills URA which is anticipated to develop beyond the 20-year planning horizon. Future customers within the North Hills URA above approximately 440-foot elevation are assumed to be served by a future Zone 4.

Future water demand within the proposed 20-year Zone 3 boundary is estimated based on land use classifications from the Yamhill County Comprehensive Plan, City zoning for similar adjacent properties, the *Springbrook Master Plan* and per capita water demands presented earlier in this section. Timeframes for potential development were estimated in 5-year blocks for each parcel within the UGB based on their proximity to existing development and infrastructure as well as property ownership.

Table 2-4
Future Water Demand by Pressure Zone
See Note 1

Forecast Water Demand (mgd)						
Zone	5-Year		10-Year		20-Year	
	ADD	MDD	ADD	MDD	ADD	MDD
1	2.58	5.16	2.97	5.93	3.59	7.18
2	0.27	0.54	0.27	0.54	0.27	0.54
3	0.01	0.02	0.02	0.05	0.03	0.06
Total	2.86	5.72	3.26	6.52	3.89	7.78

North Hills URA Demand

A high level estimate of ultimate water demand in the City's North Hills URA is included in this section as this area's anticipated future growth impacts the sizing of the proposed Bell Road storage reservoir discussed in more detail in **Section 5**. The North Hills URA is anticipated to develop beyond the 20-year planning horizon. Customers in the North Hills URA below approximately 310 feet elevation will be served by extending existing Zone 1 distribution mains.

Customers above 310 feet and below approximately 440 feet elevation will be served from proposed Zone 3. Customers above approximately 440 feet are assumed to be served by a future Zone 4.

Future water demand in the City’s North Hills URA is estimated at 11 persons per acre based on the City’s 2009 URA analysis presented to the Oregon Land Conservation and Development Commission (LCDC) and current water demand per capita presented earlier in this section. Estimated demand beyond 20 years for the North Hills URA is summarized in **Table 2-5**.

**Table 2-5
North Hills URA Future Water Demand**

Future Pressure Zone	Land Area (acres)	Projected Growth beyond 20-years		
		Population (at 11 persons/acre)	Water Demand (mgd)	
			ADD	MDD
1	27.5	303	0.03	0.06
3	272.2	2,994	0.30	0.60
4	100.7	1,108	0.11	0.22

SECTION 3

PLANNING AND ANALYSIS CRITERIA

This section presents the planning and analysis criteria used to analyze performance of the City of Newberg (City) water system. Criteria are presented for water supply, distribution system piping, service pressures, storage and pumping facilities. Recommended water needs for emergency fire suppression are also presented. These criteria are used in conjunction with the water demand forecasts developed in **Section 2** to complete analysis of the City's water source presented in **Section 4** and distribution system presented in **Section 5**.

The recommendations of this plan are based on the following performance guidelines, which have been developed through a review of State requirements, American Water Works Association (AWWA) acceptable practice guidelines, *Ten States Standards* and the *Washington Water System Design Manual*. These performance criteria are consistent with the City's 2015 *Public Works Design & Construction Standards*.

Water Supply Capacity

As described in **Section 1**, the City draws its supply from a well field across the Willamette River from the Newberg water service area and the Water Treatment Plant (WTP). Water is supplied from the well field to the WTP through two large-diameter raw water transmission mains, one suspended from a decommissioned highway bridge and the other buried beneath the riverbed. At the WTP, raw water is treated through conventional filtration to remove high levels of dissolved iron in the well source water. After treatment, finished water is pumped by the High Service Pumps from the WTP clearwell through the distribution system to storage reservoirs. The City's overall supply capacity is impacted by each of these components; water source, raw water transmission (river crossings), water treatment plant and high service pumps.

Normal Operating Supply

Under normal operating conditions, the City should plan for adequate firm capacity to supply maximum day demand (MDD) from the well field to the WTP and distribution storage. Firm capacity is defined as total capacity with the largest facility out of service. Supply components are evaluated at firm capacity to provide for system redundancy. Redundancy allows components to be taken out of service, as needed, for both unscheduled repairs and regular maintenance. For the City's supply components firm capacity criteria are as follows. The City's total supply capacity is limited by the source, transmission or treatment component with the smallest firm capacity.

- **Source** – MDD available with the largest well out of service
- **Raw water transmission (river crossings)** – minimum of two transmission main river crossings, MDD available with one crossing out of service

- **Water Treatment Plant** – minimum of two parallel treatment trains, MDD available with one train out of service
- **High Service Pumps** – minimum of three pumps, MDD available with the largest pump out of service

Redundant Supply

The well field is the City's only existing source. This source may be vulnerable to flooding or other natural disasters. Existing raw water transmission mains across the Willamette River from the well field to treatment and customers may also be vulnerable to ground movement, seismic activity or other natural disasters. Due to the potential vulnerability of the existing supply system, the City should plan for adequate redundant supply capacity to provide one day of wintertime average water demand. It is assumed that new redundant sources would preferably be located on the north side of the Willamette River.

Distribution System Capacity and Service Pressures

Pressure Zone Configuration

Water distribution systems are separated by ground elevation into pressure zones in order to provide service pressures within an acceptable range to all customers. Typically, water from a reservoir will serve customers by gravity within a specified range of ground elevations so as to maintain acceptable minimum and maximum water pressures at each individual service connection. When it is not feasible or practical to have a separate reservoir for each pressure zone, pump stations or pressure reducing valves (PRVs) are used to serve customers in higher or lower pressure zones respectively from a single reservoir.

Currently, the majority of Newberg water customers are served by a single pressure zone. It is anticipated that future growth at higher elevations in northeast Newberg will require development of additional pressure zones. All existing and future pressure zones should incorporate at least one of the following strategies to promote service reliability and redundancy:

- Gravity storage within the pressure zone.
- Standby pump station power.
- Multiple pump stations supplying the pressure zone.
- A PRV connection to an upper pressure zone configured for emergency and supplemental fire flow supply. These valves should be equipped with pressure sustaining features to prevent under-pressurization of the upper pressure zone.

Normal Service Pressure

The desired service pressure range under average daily demand (ADD) and normal operating conditions is 40 to 80 pounds per square inch (psi) consistent with the City's 2015 *Public Works Design and Construction Standards*. Whenever feasible, it is desirable to achieve the 40 psi lower limit at the highest fixture within a structure. The maximum 80 psi service pressure limit is required by the *Oregon Plumbing Specialty Code (OPSC) 608.2*. Conformance to this pressure range may not always be possible or practical due to topographical relief and existing system configurations. Where mainline pressures exceed 80 psi, service connections should be equipped with individual PRVs.

The distribution system should be capable of supplying the peak hourly demand (PHD) while maintaining service pressures of not less than 75 percent of normal system pressures.

Service Pressure in an Emergency

During a fire flow event or emergency, the minimum service pressure is 20 psi as required by Oregon Health Authority, Drinking Water Services (OHA) and OAR 333-061-0025(7). The system should be capable of providing fire flow capacity while simultaneously delivering MDD and maintaining 20 psi throughout the distribution system. The system should meet this criterion with operational storage in the City's reservoirs depleted.

Distribution Main Criteria

In general, distribution system main flow velocities should not exceed 8 feet per second (fps) under fire flow conditions and 5 fps under normal demand conditions. Per the City's 2015 *Public Works Design and Construction Standards*, Class 52 ductile iron is the City's standard water main pipe material. The minimum pipe size is 8-inch diameter for new permanently dead ended residential water mains and primary feeder mains in residential areas.

Water Quality

In Oregon, drinking water quality standards for 95 primary and 12 secondary contaminants are established under the Oregon Drinking Water Quality Act (OAR 333-061) which includes implementation of national drinking water quality standards. To maintain public health, each contaminant has either an established maximum contaminant level (MCL) or a recommended treatment technique.

Source Water

Potential for pathogens in groundwater sources like the City's wells are regulated by the Groundwater Rule (GWR). The City's existing wells have high levels of dissolved iron in the water. Iron is a secondary contaminant which causes metallic taste, discoloration, sediment and staining but is not a threat to human health. Dissolved iron is removed from the source

water at the City's WTP. Other regulated contaminants are monitored as required by the State's drinking water quality standards.

Distribution System

There are three drinking water quality standards and potential contaminants that may be exasperated or originate in the distribution system. Specifically, microbial contaminants (Total Coliform Rule), lead and copper (Lead and Copper Rule) and disinfection byproducts (Disinfectants and Disinfection Byproducts Rule).

Total Coliform Rule

There are a variety of bacteria, parasites, and viruses which can cause health problems when ingested. Testing water for each of these germs would be difficult and expensive. Instead, total coliform levels are measured. The presence of any coliforms in the drinking water suggests that there may be disease-causing agents in the water also. A positive coliform sample may indicate that the water treatment system isn't working properly or that there is a problem in the distribution system. Although many types of coliform bacteria are harmless, some can cause gastroenteritis including diarrhea, cramps, nausea and vomiting. This is not usually serious for a healthy person, but it can lead to more serious health problems for people with weakened immune systems.

The Total Coliform Rule applies to all public water systems. Total coliforms include both fecal coliforms and *E. coli*. Compliance with the MCL is based initially on the presence or absence of total coliforms in a sample, then a focus on the presence or absence of *E.coli*. For Newberg, the MCL is exceeded if more than five percent of the 30 required monthly samples have total coliforms present. A water system must collect a set of repeat samples for each positive total coliform result and have it analyzed for total coliforms and *E.coli*.

Lead and Copper and Corrosion Control

Lead and copper enter drinking water primarily through corrosion of plumbing materials most commonly caused by a chemical reaction with the water which may be due to dissolved oxygen, low pH or low mineral content. Exposure to lead and copper may cause health problems ranging from gastroenteritis to brain damage. In 1991, the national Lead and Copper Rule (LCR) established action levels for lead and copper concentrations in drinking water. Under the Oregon Drinking Water Quality Act, water utilities are required to implement optimal corrosion control treatment that minimizes the lead and copper concentrations at customers' taps, while ensuring that the treatment efforts do not cause the water system to violate other existing water regulations. It should be noted that an update to the LCR is currently being considered, though implications to the City's water system are anticipated to be minimal.

Utilities are required to conduct monitoring for lead and copper from taps in customers' homes. Samples are currently required to be taken every three years at 30 sampling sites. The

action level for either compound is exceeded when, in a given monitoring period, more than 10 percent of the samples are greater than the action level.

Disinfectants and Disinfection Byproducts (DBP) Rule

DBPs form when disinfectants, like chlorine, used to control pathogens in drinking water react with naturally occurring materials in source water. DBPs have been associated with increased cancer risk. The City is required to sample four locations in the distribution system on a quarterly basis.

Storage Volume

Water storage facilities are typically provided for three purposes: operational storage, fire storage, and emergency storage. A brief discussion of each storage element is provided below. Recommended storage volume is the sum of these three components. Adequate storage capacity must be provided for each pressure zone which is supplied by gravity. Storage volume for pressure zones served through pressure reducing valves (PRVs) or by constant pressure pump stations is provided in the upstream pressure zone supplying the PRV or pump station.

Operational Storage

Operational storage is the volume of water needed to meet water system demands in excess of delivery capacity from the WTP to system reservoirs under PHD conditions. Operational storage capacity is evaluated based on the equalizing storage method from the Washington State Department of Health's *Water System Design Manual* (December 2009). This method defines minimum storage as the volume required to meet PHD for 2.5 hours with all non-emergency pumps serving the zone at full capacity.

Fire Storage

Fire storage should be provided to meet the single most severe fire flow demand within each zone. The fire storage volume is determined by multiplying the recommended fire flow rate by the expected duration of that flow consistent with the 2014 *Oregon Fire Code*. Specific fire flow and duration recommendations are discussed later in this section.

Emergency Storage

Emergency storage is provided to supply water from storage during emergencies such as pipeline failures, equipment failures, power outages or natural disasters. The amount of emergency storage provided can be highly variable depending upon an assessment of risk and the desired degree of system reliability. Provisions for emergency storage in other systems vary from none to a volume that would supply a maximum day demand or higher. Newberg has a single supply source from the City's well field and WTP which may become temporarily unavailable in the event of a major transmission main break or natural disaster.

Due to this potential vulnerability, the City's emergency storage criterion is 100 percent of MDD.

Pump Station Capacity

Pumping capacity requirements vary depending on how much storage is available, the number of pumping facilities serving a particular pressure zone, and the zone's maximum fire flow requirement. Pumping recommendations are based on firm capacity which is defined as a pump station's capacity with the largest pump out of service.

Pump Station supplying Pressure Zone with Gravity Storage

For pump stations supplying pressure zones with gravity storage available the station must have adequate firm capacity to supply MDD for the zone.

Pump Station supplying Constant Pressure to Zone

Although it is desirable to serve water system customers by gravity from storage, constructing and maintaining a reservoir for a small group of customers may be prohibitively expensive and lead to water quality issues associated with slow reservoir turnover during low demand times. Constant pressure pump stations supply a pressure zone without the benefit of storage and are commonly used to serve customers at the highest elevations in a water service area where only an elevated reservoir would be capable of providing the necessary head to achieve adequate service pressures by gravity. Pump stations supplying constant pressure service should have firm pumping capacity to meet PHD while simultaneously supplying the largest fire flow demand in the zone. Constant pressure pump stations are only recommended for areas with a small number of customers and low water demand with limited potential for future looping with adjacent pressure zones.

Standby Power

Standby power facilities are needed for constant pressure stations and for pump stations serving pressure zones with inadequate emergency storage capacity. Standby power is typically provided in the form of an on-site backup generator sized to operate the pump station at firm capacity with automatic transfer switches and on-site fuel storage.

Fire Flow Recommendations

The amount of water recommended for fire suppression purposes is typically associated with the local building type or land use of a specific location within the distribution system. Fire flow recommendations are typically much greater in magnitude than the MDD in any local area. Adequate hydraulic capacity must be provided for these potentially large fire flow demands.

Fire protection within the current water service area is provided by the Newberg Fire Department or Tualatin Valley Fire and Rescue (TVFR). Fire flow requirements for

individual facilities are determined by the Fire Marshal consistent with the 2014 *Oregon Fire Code*. The City's 2015 *Public Works Design and Construction Standards* specify a distribution system design capacity of 4,500 gpm in commercial and industrial areas and 1,000 gpm in residential areas. A summary of fire flow for each land use type and approximate fire hydrant spacing is presented in **Table 3-1**.

**Table 3-1
Summary of Recommended Fire Flows**

Land Use Type (City zoning designations)	Fire Flow (gpm)	Duration (hours)	Average Fire Hydrant Spacing (feet)
Low Density Residential: (AR, R-1, SD/LDR)	1,000 ¹	2	500
Medium Density Residential: (R-2, SD/MRR)	1,500	2	500
High Density, Manufactured Dwelling and Professional Residential: (R-3, R-4, R-P)	2,000	2	450
Neighborhood Commercial: (C-1, SD/NC)	2,000	2	450
Community, Central Business District and Employment Commercial: (C-2, C-3, C-4, SD/E, SD/V)	3,000	3	400
Limited Industrial (M-1)	3,000	3	400
Light, Heavy and Airport Industrial: (M-2, M-3, M-4, AI)	4,500 ²	4	300
Institutional and Hospitality: (I, SD/H)	4,500 ²	4	300

Notes:

1. For homes over 3,600 square feet the 2014 *Oregon Fire Code* requires a minimum 1,500 gpm fire flow.
2. Maximum fire flow per 2015 *Public Works Design and Construction Standards* for commercial or industrial areas.

Summary

See Note 1

The criteria developed in this section are used in **Section 4** and **Section 5** to assess the supply and distribution system's ability to provide adequate water service under existing conditions and to guide improvements needed to provide service for future water needs. Planning criteria for the City's booster pump stations, distribution system, pressure zones, and storage facilities are summarized as follows:

- **Supply:** All supply components; source, transmission, treatment and high service pumps should be capable of providing MDD at firm capacity
- **Redundant Supply:** One day of wintertime average demand should be available preferably from a source on the north side of the Willamette River
- **Service Pressure:**
 - Normal range under ADD conditions: 40 to 80 psi
 - Maximum per *Oregon Plumbing Specialty Code*: 80 psi
 - Minimum under PHD conditions: 75 percent of normal range
 - Minimum under emergency or fire flow conditions per OHA requirements: 20 psi
- **Distribution Mains:**
 - Maximum velocity under normal operating conditions: 5 fps
 - Maximum velocity under emergency or fire flow conditions: 8 fps
- **Storage Volume:** Recommended storage volume capacity is the sum of the operational, fire and emergency storage volume components.
- **Pump Station Capacity:** Pump stations pumping to gravity storage facilities should have adequate firm capacity to provide MDD to the zone. Pump stations supplying constant pressure service without the benefit of storage should have firm pumping capacity to meet PHD while simultaneously supplying the largest fire flow demand in the pressure zone.
- **Fire Flow:** The distribution system should be capable of supplying the recommended fire flows while maintaining minimum residual pressures everywhere in the system of 20 psi.

SECTION 4

WATER SUPPLY ANALYSIS

This section presents an assessment of the City of Newberg's (City's) current water supply system, a summary of existing water rights and analysis of future supply development options. Although the City does not have an immediate need to develop additional source and treatment capacity to meet projected future water demands presented in **Section 2**. The City should consider development of water supply redundancy to address existing supply vulnerability and for long-term water system resiliency.

Existing Supply Assessment

Existing Groundwater Wells

Newberg's current water supply source consists of groundwater production wells located in the City's well field on the south side of the Willamette River, across the river from the City's water treatment plant (WTP). Currently five of the City's nine wells are in operation, and the new production Well 9 will be brought on-line in early 2017. The wells generally produce water that is high in iron, and clogging by iron-reducing bacteria has been observed. To combat clogging and maintain production capacity, the City performs scheduled redevelopment of the operational wells every seven to ten years. General observations of the condition and production capacities of the existing wells are discussed below.

Wells 1 and 2

Well 1 was constructed in 1948, and Well 2 was constructed in 1951. Each well is approximately 90 feet deep and consists of a 12-inch diameter steel casing and approximately 6 feet of perforations for the open interval. Other details of the construction, such as the seal are unknown. The tested capacity of Wells 1 and 2 was 1,500 gallons per minute (gpm) when they were constructed, and the capacity of the original pumping systems was reported to be 750 gpm. The performance history of each well is unknown. Declining yield and lack of improvement following repeated rehabilitation efforts led the City to remove the Wells 1 and 2 from operation in 2013 and 2012, respectively.

Well 3

Well 3 was constructed in 1964, and consists of an 18-inch diameter steel casing installed to a depth of 103 feet. The well has a bentonite sanitary seal from ground surface to a depth of 24 feet. The open interval consists of two sets of perforations totaling 27 feet in gravel and sand formation. The tested capacity of the well when initially constructed was 1,800 gpm with 9 feet of drawdown over a 12-hour period; however, it produced excessive sand when in operation. Because of sand production and declining yield, Well 3 was removed from operation in 1980.

Well 4

Well 4 was constructed in 1970 and consists of a 16-inch diameter production casing to a depth of 80 feet and a 14-inch diameter (nominal) screen assembly to a depth of 96 feet. The well was constructed with a 20-foot cement surface seal. The open interval consists of 10 feet of 250-slot (0.25-inch slot size) stainless steel wire-wrap screen in gravel and sand formation. The original tested capacity of the well was 1,300 gpm with 12 feet of drawdown over a 30-hour period. Despite the use of stainless steel well screen in its construction and lower iron concentrations than those observed at other City wells, Well 4 produces some sand during operation and has declined in capacity over its operational history. The most recent rehabilitation of the well, completed in 2014, resulted in minimal improvement to the Well 4 production capacity. The City continues to operate Well 4 as a supplemental supply well for the well field. Well 4 is equipped with a variable frequency drive (VFD) pump motor and currently produces between 350 and 400 gpm.

Well 5

Well 5 was constructed in 1980 and was originally tested at 1,800 gpm with 13 feet of drawdown over 24 hours. The well consists of a 16-inch diameter production casing to a depth of 64 feet and a 14-inch diameter (nominal) screen assembly from 56 to 88.5 feet. The well is constructed with a cement surface seal to a depth of 34 feet. The open interval consists of stainless steel screen from 64.5 to 82.5 feet and perforated steel casing from 83.5 to 86.5 feet in gravel and sand formation. Historically, Well 5 experienced a great deal of interference from pumping at Wells 1, 2, and 3, and the pumping water level consistently fell to the level of the pump intake during the summer. Under current operations Well 5 sees interference from pumping at Well 6 and, to a lesser extent, at Wells 7 and 8. Well 5 has declined in capacity over its operational history. The most recent rehabilitation of this well, completed in 2014, resulted in minimal improvement. The City continues to operate Well 5 as a supplemental supply well for the well field. Well 5 is equipped with a VFD and currently produces between 400 and 425 gpm.

Well 6

Well 6 was constructed in 1980 and was originally tested at a rate of 2,575 gpm with 16 feet of drawdown after 24 hours. The well consists of 16-inch production casing to a depth of 70.5 feet, and a 14-inch (nominal) screen assembly from 62 feet to 95.5 feet. The well was constructed with a cement surface seal to a depth of 34 feet. The open interval consists of stainless steel wire-wrap screen between 70.5 feet and 90.5 feet in gravel and sand formation. The well has exhibited only minor reduction in capacity over its operational history and is scheduled for rehabilitation in 2016. Due to its central location in the well field, Well 6 sees interference from pumping at all of the operational wells. Well 6 is equipped with a VFD and is currently operated at rates between 900 and 1,600 gpm.

Well 7

Well 7 was constructed in 2000 and was originally tested at a rate of 1,500 gpm with 11 feet of drawdown over a 73 hour period. The well consists of a 16-inch diameter production casing to a depth of 65 feet and a 14-inch diameter (nominal) screen assembly between 56 feet and 89 feet. The well was constructed with a cement surface seal to a depth of 46 feet. The open interval consists of stainless steel wire-wrap screen from 67 to 77 feet and 83 to 89 feet in gravel and sand formation. The well has exhibited very minor reduction in capacity over its operational history, and the most recent well rehabilitation was completed in 2012. Well 7 sees interference from pumping at Wells 6 and 8. Well 7 is equipped with a VFD and is currently operated at rates between 1,000 and 1,700 gpm.

Well 8

Well 8 was constructed in 2006 and was originally tested at a rate of 4,000 gpm with 17 feet of drawdown over a 47 hour period. Based on the testing results and estimated interference, the recommended long-term design operational rate for the well was 2,500 gpm. The well consists of a 20-inch diameter production casing to a depth of 60 feet, and an 18-inch diameter (nominal) screen assembly. The well was constructed with a cement seal from 13 feet to 53 feet and bentonite from 4 feet to 13 feet. The open interval consists of stainless steel wire-wrap screen from 53 to 79 feet and 89 to 95 feet in gravel and sand formation. The well has exhibited very minor reduction in capacity over its operational history, and the most recent well rehabilitation was completed in 2013. Well 8 sees interference from pumping at Wells 6 and 7. Well 8 is equipped with a VFD and is currently operated at rates between 1,700 and 2,300 gpm.

Well 9

Well 9 was completed in 2016 with a design similar to Wells 7 and 8 and production capacity of approximately 1,800 gpm. It is anticipated that Well 9 will experience interference from pumping at the other operational wells, and pumping at Well 9 will likewise cause additional interference at the other operational wells. Well 9 is not equipped with a VFD. The operational pumping rates of the nearby wells are likely to be reduced as a result of the additional well interference and the non-varying production rate at Well 9.

Current Source Capacity Estimates

The total well field capacity is sensitive to changes in groundwater levels because the source aquifer beneath the well field is relatively shallow. In addition to the natural variation of the groundwater level of the aquifer due to changes in the Willamette River level (stage) and seasonal variations in precipitation (higher in the winter and lower in the summer), the groundwater level is also affected by the rate and volume of groundwater withdrawn from the City's well field.

At each production well there is a limited amount of available drawdown. Drawdown is the difference between the water level in the well and the top of the open interval of the well. During pumping, the available drawdown in the well decreases as the water level in the well falls. In addition, each pumping well creates a cone of drawdown that expands laterally away from the well as pumping continues. The decrease in available drawdown at a well caused by the pumping at another well is called interference. Interference is generally greater in wells that are constructed close together. Over longer periods of pumping, the cone of drawdown can expand to the lateral extent of the aquifer or to areas that are less productive, called boundaries, which can affect the rate of drawdown at the wells.

Available operational data indicate that the total well field capacity decreases after several days of continuous pumping due to the cumulative effects of interference and aquifer boundary conditions. For this reason, estimates of maximum source capacity were developed for one day and three days based on typical peak demand operational scenarios. Source capacity estimates include projections for Well 9, assuming a specific capacity similar to Well 7 and a non-varying flow rate of 1,800 gpm which is the capacity of the pump to be installed at Well 9. Firm source capacity estimates assume Well 8 is non-operational. Firm capacity is defined as total source capacity with the largest source, Well 8, out of service. Capacity estimates presented herein use conservative Willamette River stage levels to estimate available drawdown. More or less capacity may be available at any given time, depending on aquifer conditions and well performance. Estimates of maximum and firm source capacities, in million gallons per day (mgd), are presented in **Table 4-1**.

**Table 4-1
Source Capacity Estimates**

Aquifer Conditions	Capacity (mgd)			
	1-Day Max	1-Day Firm	3-Day Max	3-Day Firm
Summer (Low-Water)	11.6	8.5	9.0	8.4
Winter (High-Water)	11.8	8.5	10.6	8.5

Water Rights Summary

The City holds six municipal groundwater rights, including four water right certificates, one permit, and one groundwater registration. All of these water rights authorize use of groundwater from the City’s well field located in the alluvial aquifer adjacent to the Willamette River, and in combination authorize 35.16 cubic feet per second (cfs) or 15,779 gpm of water right appropriation rate. The majority of the City’s water rights are relatively free of water use conditions, and the City is in compliance with the few water use conditions that are attached to its water rights.

Groundwater Registration GR-63, the City's oldest water right, authorizes the use of 1,000 gpm (2.228 cfs) from each of the City's original two water supply wells, Well 1 and Well 2 (2,000 gpm in total). The City does not currently use these wells for supply because of diminished capacity and sand pumping.

Certificates 68620 and 82595 authorize a combined appropriation rate of 1,800 gpm (4.01 cfs) from Well 5. Although the production capacity of Well 5 was once sufficient for appropriating the full rate of these water rights, the capacity of Well 5 has declined over time to a current rate of 425 gpm.

Certificates 48100 and 82600, authorize an appropriation rate of 1,203 gpm (2.68 cfs) from Well 4 and 1,800 gpm (4.01 cfs) from Well 6, respectively. Similar to Well 5, the production capacity of Well 4, and to a lesser degree Well 6, have declined over time and the City can no longer appropriate the full water right rate from these wells.

The City's remaining water right, Permit G-17583 (formerly G-13876), authorizes the appropriation of up to 8,977 gpm (20.0 cfs) from six wells, including one collector well. Three of the six wells, Wells 7, 8, and 9, have been constructed and the City currently appropriates a combined total of up to 5,800 gpm from these wells under this permit (65% of the permit authorized rate). The City has an approved extension of time for this permit that extends the date to complete construction to October 1, 2054 and the date to apply water to full beneficial use to October 1, 2055. The City is authorized to appropriate up to 7,917 gpm (17.64 cfs) of the total permit authorized rate under its currently approved Water Management and Conservation Plan (WMCP). Access to additional rate under the permit, up to the maximum authorized rate, will require an update of the City's WMCP justifying the need for the additional rate. An updated WMCP must be submitted to the Oregon Water Resources Department (OWRD) by July 17, 2019 per a condition of the final order approving the City's current WMCP.

Table 4-2 provides an inventory of the City's water rights. **Table 4-3** provides a summary of the City's current well production capacity and the allocation of the City's water right capacity by well.

Table 4-2
City of Newberg Water Rights for Use of Groundwater

Application	Permit	Certificate or Registration	Aquifer	Associated Wells	Authorized Use	Priority Date	Authorized Rate	
							(cfs)	(gpm)
--	--	GR-63	Alluvial	Well 1 and Well 2	Municipal	9/30/1951 (Well 1) 5/31/1948 (Well 2)	2.228 (Well 1) 2.228 (Well 2)	1000 (Well 1) 1000 (Well 2)
G-5277	G-5277	68620	Alluvial	Well 5	Municipal	8/5/1970	3	1346
G-5254	G-5276	48100	Alluvial	Well 4	Municipal	7/20/1970	2.68	1203
G-9638	G-10067	82595	Alluvial	Well 5	Municipal	3/28/1980	1.01	453
G-9805	G-10068	82600	Alluvial	Well 6	Municipal	6/23/1980	4.01	1800
G-12515	G-17583		Alluvial	Well 7, 8 and 9 (existing) Well 10 and 11 (proposed) Collector Well (proposed)	Municipal	5/3/1991	20	8977

**Table 4-3
Allocation of Water Right Capacity - Groundwater**

Water Right ▶				GR-63	68620 T-4547 48104 Per. G-5277 App. G-5277	48100 Per. G-5276 App. G-5254	82595 Per. G-10067 App. G-9638	82600 Per. G-10068 App. G-9805	Per. G-13876 T-12202 (submitted 11/16/2015) T-9098 (approved) App. G-12515		
Priority date				9/30/1951 (Well 1) 5/31/1948 (Well 2)	8/5/1970	7/20/1970	3/28/1980	6/23/1980	5/3/1991		
Certificate date				n/a	10/10/1995	5/25/1979	11/3/2006	11/3/2006	n/a		
Appropriation Rate Authorized (cfs)				2.228 (Well 1) 2.228 (Well 2)	3.00	2.68	1.01	4.01	20.00		
Appropriation Rate Authorized (gpm)				2,000	1,346	1,203	453	1,800	8,977		
Authorized Type of Use				Municipal	Municipal	Municipal	Municipal	Municipal	Municipal		
Well Name	Well Log	Aquifer	Well Production Capacity ¹ (gpm)	Water Right Use Allocated by Well (gpm)						Well Production Capacity Allocated (gpm)	Well Production Capacity Remaining (gpm)
Well 1	MARI 191/194	Alluvial	0	0	n/a	n/a	n/a	n/a	n/a	0	0
Well 2	MARI 190/192	Alluvial	0	0	n/a	n/a	n/a	n/a	68620 and	0	0
Well 3	MARI 185	Alluvial	0	n/a	n/a	n/a	n/a	n/a	n/a	0	0
Well 4	MARI 188	Alluvial	400	n/a	n/a	400	n/a	n/a	n/a	400	0
Well 5	MARI 182	Alluvial	425	n/a	425	n/a	0	n/a	n/a	425	0
Well 6	MARI 181	Alluvial	1600	n/a	n/a	n/a	n/a	1600	n/a	1600	0
Well 7	YAMH 51996	Alluvial	1700	n/a	n/a	n/a	n/a	n/a	1700	1700	0
Well 8	MARI 59721	Alluvial	2300	n/a	n/a	n/a	n/a	n/a	2300	2300	0
Well 9	Proposed	Alluvial	0	n/a	n/a	n/a	n/a	n/a	0	0	0
Well 10	Proposed	Alluvial	0	n/a	n/a	n/a	n/a	n/a	0	0	0
Well 11	Proposed	Alluvial	0	n/a	n/a	n/a	n/a	n/a	0	0	0
Collector Well	Proposed	Alluvial	0	n/a	n/a	n/a	n/a	n/a	0	0	0
Appropriation Rate Allocated (gpm)				0	425	400	0	1600	4000	6425	0
Appropriation Rate Remaining (gpm)				2000	921	803	453	200	4977	9354	0

Notes:

¹ Based on Well Field Flow Combinations_2015 March.pdf

Transmission

Transmission of raw (untreated) water from the City's groundwater wells across the Willamette River to the WTP is provided by two parallel transmission mains.

The older 24-inch diameter cast iron main is suspended from a decommissioned highway bridge. The approaches to the former Highway 219 bridge have been demolished and the bridge is now owned and maintained by the City for the sole purpose of carrying the water transmission main from the well field to the WTP. The City does not have a formal maintenance or inspection program for the bridge structure. In 2016, a river bank failure occurred next to the bridge's northern end. The City is currently investigating any impact to the transmission main from this event and conducting an assessment of potential slope instability and mitigation strategies at the bridge crossing. The 24-inch bridge transmission main is assumed to be vulnerable to failure during a seismic event due to either potential failure of steel structural members in the existing bridge or slope instability.

A second 30-inch diameter high density polyethylene (HDPE) transmission main, constructed downstream of the bridge crossing in 2006, carries water from the well field under the Willamette River to the WTP. This crossing is considered more resistant to a seismic event due to the flexibility of the pipe material. Flexible joints, which allow slight pipe displacement during a seismic event were not incorporated into the pipeline design at either end of the river crossing. All existing fittings and joints are restrained.

Treatment

See Note 1 & Note 2

The City's existing WTP has a nominal capacity of 9 mgd. Overall plant capacity is currently limited by dual 12-inch diameter piping between the well field transmission mains and WTP settling basins. If the WTP is operated at 9 mgd, water flows from the dual 12-inch diameter mains into the settling basins at high velocity causing it to splash back over the settling basin wall. To mitigate this splash back and ensure proper mixing in the settling basin, the WTP is operated at a maximum capacity of approximately 8 mgd. The existing 8 mgd effective WTP capacity is adequate to meet projected demands of 7.78 mgd through the 20-year planning horizon.

Future Supply

See Note 2

As presented in **Section 3**, the City's current water supply system relies solely upon the well field source water piped across the Willamette River to treatment and customers. Both the well field and at least one transmission main may be vulnerable to flooding, ground movement, seismic activity or other natural disasters. Given these potential vulnerabilities it is recommended that the City assess redundant supply options on the north side of the Willamette River.

Any potential drinking water supply system has three primary components: source, transmission and treatment. Transmission must be provided for both raw water, from the

source to treatment and finished water, from treatment to storage and customers. For a water supply system to be feasible each of these three primary components must be analyzed for their capacity, location and cost. Potential sources are also evaluated for their water quality as this impacts the needed treatment. As illustrated in **Figure 4-1** at the end of this section, a fatal flaw at any one of these evaluation steps may lead to elimination of a proposed source as a feasible option.

Required Capacity

It is recommended that the City evaluate redundant supply sources based on a required capacity of one day of wintertime (non-peak) average daily demand. Based on historical water production records from the WTP, current wintertime average demand is approximately 2 mgd.

Groundwater Source Expansion Assessment

Several alternatives for groundwater source expansion were evaluated on the basis of favorable hydrogeology and the availability of water rights. A detailed discussion of the evaluation is provided in **Appendix C**, and the key outcomes are summarized below.

Hydrogeology

The four major geologic units present in the Newberg area (shown in **Appendix C, Figure 1**) were evaluated for potential to develop a new groundwater source:

1. The marine sediment unit was eliminated from further consideration for a new groundwater source because of poor water quality and low well yields.
2. The nature and distribution of Columbia River Basalt Group (CRBG) aquifers are not well characterized in the Newberg area. The CRBG aquifers outside and in the northern part of the City, where known to be present, are compartmentalized and have low to medium yields and declining water levels. The presence, thickness, and productivity of the CRBG in the southern portion of the City is unknown, and exploration would require a significant investment. The CRBG aquifers were eliminated from further consideration for a new groundwater source.
3. The basin-fill sediment unit was eliminated from further consideration for a new groundwater source because of low well yields.
4. The younger alluvium unit consists of sediments deposited within the floodplain of the Willamette River. The coarser section of the unit comprises the alluvial aquifer, the most productive aquifer in the Newberg area, and is the source of supply for the City's well field. The highest-potential alternative for developing a new, high-capacity groundwater source is to target the coarse material found in the younger alluvium near the Willamette River.

Water Rights

See Note 2

Four different alternatives for obtaining authorization to appropriate water from a new source were evaluated:

1. Obtain a new surface water right, should the City desire to develop a new surface source
2. Acquire an existing surface water right
3. Obtain a new groundwater right
4. Utilize (transfer) the City's existing groundwater rights

All four of the alternatives were found to be feasible, with availability of groundwater rights (new or transferred) limited to the alluvial aquifer present near the Willamette River.

Aquifer Storage and Recovery (ASR)

In addition to the considered alternatives for developing a new groundwater source, ASR also was considered as a strategy for enhancing supply capacity during periods of high demand. ASR is the underground storage of treated drinking water in a suitable aquifer and the subsequent recovery of the water from the same well or wells, generally requiring no re-treatment other than disinfection. The specific alternative evaluated was an ASR system using treated alluvial groundwater from the WTP as the injection source and using the CRBG as the storage aquifer. As discussed above, the presence, structure, and productivity of the CRBG in the Newberg area is highly uncertain. The ASR alternative was not considered further in this evaluation because of the high cost to develop and test an ASR site and the high uncertainty regarding the suitability of the CRBG aquifers in the area for ASR.

Source Expansion Alternatives

See Note 2

The preliminary expansion assessment indicated that the alluvial aquifer provides the best opportunity for developing additional groundwater source capacity. Two overall alternatives for developing additional source capacity in the alluvial aquifer are available to the City:

- **Alternative 1** – expand existing well field capacity
- **Alternative 2** – develop capacity on the north side of the Willamette River

Two targeted options (Option A and B) were identified and evaluated within each of these alternatives.

Alternative 1 - Well field Capacity Expansion

The City has completed several studies since 1980 to evaluate the potential to develop groundwater supplies from the alluvial aquifer within the floodplain on the south side of the Willamette River. The outcome of these studies was continued expansion of the City's Marion County well field, centered on the thickest known section of saturated aquifer. The City has fully developed the pumping capacity of the majority of this channel feature, although the capacities of two wells (4 and 5) have diminished over time. While the aquifer becomes appreciably thinner northwest and south of the existing well field (**Appendix C, Figure 2**), the thickness and nature of the aquifer and potential presence of additional channel features have not been fully explored on the south end of the City's parcel, nor in the northerly portions of the adjacent parcel. The presence of undeveloped alluvial aquifer on the City's parcel and adjacent areas, and the diminished capacity of the City's older wells present a couple of options for developing additional capacity on the south side of the river. These options could be implemented independently or collectively:

- **Option 1A** - Evaluate whether the capacities of Well 4 and Well 5 can be restored and/or whether replacing Well 4 would be beneficial
- **Option 1B** - Fully explore the City's parcel and nearby areas, and drill a new well(s) based on the results of this exploration

Option 1A Improve or Replace Existing Wells in the Well field

This option would involve evaluating whether the performance of older existing Wells 4 and 5 could be restored to improve overall source capacity, and if not, whether the City should consider replacing Well 4. The performance and capacities of Wells 4 and 5 have been significantly diminished since originally installed. Recent advances in well assessment and rehabilitation methods may better inform the City whether to continue to operate these assets as-is or consider implementing a thorough and structured rehabilitation program to restore their capacity. One possible conclusion of the assessment would be that completing a comprehensive rehabilitation program would not be worthwhile. The assessment could also include an evaluation of whether replacing Well 4 would significantly improve overall source capacity given that Well 4 is located at a sufficient distance from the remainder of the wells to be less affected by interference.

Advantages:

- The existing well locations have been well-characterized.
- The City owns the property occupied by the existing wells and has land use approvals to use the parcel for municipal drinking water.
- The City holds undeveloped water right capacity for this aquifer. Changes to the City's water rights to add or move well locations should be relatively simple.
- Much of the access, power and conveyance infrastructure necessary to add capacity is already in place.

Disadvantages:

- Option 1A does not address the objective of developing supply redundancy on the north side of the river.

Option 1B Develop New Wells in the Well field or on Adjacent Parcel

A 1992 study for the City of Newberg by CH2M Hill estimated the capacity of a new well drilled within the thinner (~20 feet) section of the alluvial aquifer to be between 450 and 700 gpm. However, the well capacity potential for certain portions of the City's parcel and the adjacent western parcel is not fully understood because the depth, thickness and nature of the alluvial aquifer has not been fully explored. Option 1B would involve exploration to fill-in information gaps about the thickness of the alluvial aquifer on the City's parcel. The desired capacity increment would then be developed by installing wells in the most advantageous locations. Locations would be identified based on capacity, property, permitting, and infrastructure (power and conveyance) costs.

Advantages:

- The City owns the property occupied by the existing wells and has land use approvals to use the parcel for municipal drinking water.
- The City holds undeveloped water right capacity for this aquifer. Changes to the City's water rights to add or move well locations should be relatively simple.
- Much of the access, power and conveyance infrastructure necessary to add capacity is nearby.

Disadvantages:

- Option 1B does not address the objective of developing supply redundancy on the north side of the river.
- The yield of individual wells may be significantly lower than the City's existing wells, resulting in a higher cost per unit capacity.
- The City does not own the adjacent parcel.

Alternative 2 - North Side Capacity Development

This alternative involves developing source capacity through new wells in the alluvial aquifer on the north side of the Willamette River. Target areas (options) for exploring the presence and nature of the alluvial aquifer include: They are illustrated in **Appendix C, Figures 1 and 3.**

- **Option 2A Gearns Ferry Area** - floodplain in the vicinity adjacent to Highway 219
- **Option 2B Southwest Area** - floodplain between Rogers Landing County Park (County Park) and the City of Dundee

Option 2A Develop New Wells in the Gearn's Ferry Area

The Gearn's Ferry Area was identified during previous groundwater supply studies as having potentially favorable conditions for developing a groundwater supply source from the alluvial aquifer (CH2M Hill, 1997). The Gearn's Ferry Area includes two parcels owned by Chehalem Parks and Recreation District (CPRD) adjacent to the east and west sides of Highway 219. The remainder of the Gearn's Ferry Area is privately-owned. Nearly all of the floodplain is in cultivation and the land is designated exclusive farm use (EFU).

The City completed a limited evaluation of the groundwater supply potential of the eastern portion of the CPRD property in 2006 (GSI, 2006). The evaluation was based on the identification of productive aquifer conditions in two irrigation wells located on the Willamette Farms property to the east of the CPRD parcel and an irrigation/domestic well located to the west (**Appendix C, Figure 4**). The investigation included drilling an exploratory borehole on the east edge of the CPRD property and water quality testing of the Willamette Farms wells. Although the test borehole did not intercept a thick sequence of productive material, the majority of the CPRD property remains unexplored and appears to have potential to host a thicker sequence of productive alluvial aquifer materials. The 2006 investigation did identify the presence of cyanide in a sample from one of the Willamette Farms wells, likely a residue from agricultural chemical use. Consequently, additional investigation of groundwater quality and current agricultural practices at the Willamette Farms and CPRD parcels, as well as water quality testing on the CPRD site, would be necessary to assess the risks to source water quality prior to investing in a supply source at this location.

Advantages:

- Option 2A addresses the City's objective of developing redundant capacity on the north side of the river to improve system resiliency.
- Some property is publicly owned.
- Water rights currently held by the City could be used for wells completed in the alluvial aquifer.
- Wells in the vicinity indicate productive aquifer materials are present nearby.

Disadvantages:

- Potential well yields and water quality are uncertain because the area has not been adequately explored.
- Land use related risks to water quality must be evaluated.
- The area is distant from existing conveyance infrastructure.

Option 2B Develop New Wells in the Southwest Area

The Southwest Area, encompassing the floodplain between County Park and the City of Dundee, is the other proximal area with potentially-favorable hydrogeologic conditions for development of a groundwater source in the alluvial aquifer on the north side of the river

(Appendix C, Figure 5). However, this particular area has several challenges, and thus is less favorable than the Gearns Ferry Area in Option 2A.

Similar to the CPRD property, further investigation is necessary to evaluate the feasibility of developing a groundwater source in the Southwest Area. Two primary data gaps must be addressed: (1) verify the presence and pumping capacity of the aquifer, and estimate well yields; and (2) evaluate groundwater quality, potential landfill impacts, and current and potential future agricultural practices to assess risks to source water quality.

Advantages:

- Option 2B addresses the City’s objective of developing redundant capacity on the north side of the river to improve system resiliency.
- Water rights currently held by the City could be used for wells completed in the alluvial aquifer.

Disadvantages:

- Very little information is available to assess the yield potential in the area.
- The proximity of the closed landfill may have negative implications for water quality, and the risk of contamination must be evaluated thoroughly.
- Privately held agricultural land designated EFU may present access and land use challenges.
- The area is distant from existing conveyance infrastructure.

Source Conclusion

The groundwater source expansion assessment identified two overall alternatives for developing additional source capacity in the alluvial aquifer, and for each of the two alternatives, the two best options were evaluated:

- Alternative 1 – expand existing well field capacity
 - Option 1A – improve or replace existing wells in the well field
 - Option 1B – develop new wells in the well field or on adjacent parcel
- Alternative 2 - develop capacity on the north side of the Willamette River
 - Option 2A – develop new wells in the Gearns Ferry Area
 - Option 2B – develop new wells in the Southwest Area

While Options 1A and 1B hold significant advantages, such as, a well-characterized aquifer, existing land use approvals, simple water right transactions, and proximity to infrastructure, they do not address the City’s high-priority objective of developing supply redundancy on the north side of the Willamette River.

Options 2A and 2B address this important objective, and they share several advantages and disadvantages, such as, similar water rights framework, little information to predict well

yields, and distance to existing infrastructure. Option 2B is considered less favorable than Option 2A because there is less available information to assess potential yield, there is greater uncertainty about water quality, and there is no publicly-owned land in the vicinity.

Based on this analysis, the best source expansion option is Option 2A. This option meets the objective of developing redundant supply on the north side of the Willamette River. The information related to existing wells in this area indicates the alluvial aquifer has productive material here. The City's existing water rights could be used for wells in the alluvial aquifer in the Gearn's Ferry Area, and some property is publicly owned by the CPRD.

In addition to further exploration to identify alluvial aquifer characteristics in the area, impacts to water quality from surface activities such as agriculture must also be evaluated.

Although this appears to be the most feasible option for redundant supply currently, it is anticipated that the City will evaluate other source water options as opportunities arise.

Transmission and Treatment for Redundant Supply

It is anticipated that new wells developed in the alluvial aquifer would require treatment for high levels of iron and manganese consistent with the City's existing wells. Based on a proposed north side well location in the Gearn's Ferry Area (Option 2A), approximately 2 miles of transmission mains would be needed to carry raw water from a proposed well to the existing WTP. Alternatively, water could be treated at the well site using oxidation and a pressure filter system for iron and manganese followed by on-site disinfection. Approximately 1.3 miles of finished water transmission mains along Highway 219 would then carry the treated water to existing distribution at NE Wynooski Road. Treatment at the proposed well site is the recommended option for planning purposes because less transmission piping is required and a separate treatment system makes the proposed well a truly independent redundant supply. Much of the recommended exploration area is within the 100-year flood plain. Depending on the final well site selected, siting treatment facilities on nearby parcels of higher ground out of the flood plain may be an important consideration in developing this redundant supply.

Redundant Supply Estimated Cost

See Note 2

The City should pursue a redundant supply in the Gearn's Ferry area on the north side of the Willamette River near the current Highway 219 bridge. The redundant supply, with an approximate capacity of 2 mgd, would consist of a new groundwater well, on-site treatment for iron and manganese, on-site disinfection and approximately 1.3 miles of 12-inch diameter transmission mains from the new well to existing distribution at Highway 219 and NE Wynooski Road. **Table 4-4** summarizes planning level costs for each of these supply components. As described under *Source Expansion Alternatives* earlier in this section, additional exploration is needed in the Gearn's Ferry area to confirm hydrogeology and water quality prior to selecting a final well site. Costs for this additional exploration are also included in **Table 4-4**.

**Table 4-4
Redundant Supply Cost Estimate Summary**

Supply Component	Development Phase or Facility	Item Description	Assumptions	Total Cost
Source	Feasibility and Exploration	Water Rights Evaluation	Review water rights and permitting alternatives, meet with OWRD to determine next steps for permitting	\$ 2,500
		Geophysical Explorations	Two field days, consultant provides field support for contractor	\$ 27,500
		Subsurface Investigation and Testing	Sonic borings, 6-inch test well with two 2-inch monitoring wells	\$ 128,000
		Water Quality Assessment	Three water quality samples submitted for metals, pesticides and cyanide	\$ 5,000
	Well Development	2 mgd Production Well	One well only	\$ 360,000
		Water Rights Preparation		\$ 5,000
	Well house and well head Improvements			\$ 500,000
Treatment	Iron and Manganese	On-site oxidation and filtration	Sodium hypochlorite injection for oxidation, manganese dioxide media pressure filter for filtration	\$ 450,000
	Disinfection	On-site injection of sodium hypochlorite	Bulk sodium hypochlorite delivered to site, no on-site generation	\$ 150,000
Transmission	Finished Water Transmission Main	12-inch diameter ductile iron		\$ 1,991,000
TOTAL Redundant Supply Development Cost				\$ 3,619,000



SECTION 5

WATER DISTRIBUTION SYSTEM ANALYSIS

This section presents an analysis of the City of Newberg's (City's) water distribution system based on criteria outlined in **Section 3**. The water demand forecasts summarized in **Section 2** are used in conjunction with analysis criteria to assess water system characteristics including service pressures, storage and pumping capacity and emergency fire flow availability. This section provides the basis for the recommended Capital Improvement Program (CIP) presented in **Section 7**.

Pressure Zone Analysis

Pressure zones are defined by ground topography. Their hydraulic grade lines (HGLs) are determined by overflow elevations of water storage reservoirs, discharge pressures of pump stations or outlet settings of pressure reducing facilities serving the zone. The City's two existing pressure zones provide adequate service pressure to all customers. A third pressure zone is recommended within the 20-year planning horizon to supply potential new development at higher elevations northeast of the existing service area. Beyond 20 years it is anticipated that a fourth pressure zone will be needed to serve customers at the highest elevations in the City's North Hills Urban Reserve Area (URA). Proposed Zone 4 is not explicitly addressed in the distribution system analysis as it is outside of the 20-year service area for this Master Plan. Existing and proposed future pressure zones are illustrated on the water system maps in **Appendix A**.

Existing Pressure Zones

The City's existing distribution system is almost entirely served from Zone 1 which is supplied by the Water Treatment Plant (WTP) and the North Valley and Corral Creek Reservoirs at approximate HGL of 403 feet. Zone 1 provides adequate service pressure to customers below approximately 310 feet elevation. Zone 2, serving the Oak Knoll neighborhood at the northern edge of Newberg, is supplied by constant pressure pumping from the Oak Knoll Pump Station. Zone 2, with an approximate HGL of 470 feet, currently provides adequate service pressure to customers between approximately 310 and 350 feet elevation.

Zone 2 North Expansion to Veritas School Site

The City has entered an agreement to expand Zone 2 water service from the Oak Knoll Pump Station north on N College Street to the proposed Veritas School property at the intersection of N College Street and NE Bell Road. An 8-inch diameter main was recently completed from Oak Knoll Pump Station along N College Street to the school property. In addition to the school, other properties north of the Zone 2 boundary including the North Valley Friends Church and a proposed 11-unit residential development at 4016 N College (Rourke Property) are expected to connect to City water service from this 8-inch main. For the purposes of this

analysis, completion of these additional Zone 2 customer connections is assumed to occur within the next 5 years as reflected in the future water demand by pressure zone summarized in **Table 2-4** in **Section 2**.

Required fire flow has yet to be determined by the Newberg Fire Marshal for these proposed Zone 2 future customers as they are currently outside of the city limits. For this analysis it is assumed that the maximum fire flow required in Zone 2 will continue to be 1,000 gpm. However, to be consistent with the City's 2015 *Public Works Design and Construction Standards*, when the properties are annexed into the City of Newberg, it is likely the required fire flow without automatic fire sprinklers for the church and school will be at least 3,000 gpm and up to 4,500 gpm. The existing Oak Knoll Pump Station does not have adequate capacity under any conditions to supply a fire flow requirement larger than 1,260 gpm, which is the current nominal capacity of the station with all pumps operating.

Proposed Future Pressure Zones

As development continues in the Urban Growth Boundary (UGB) and the City's water service area expands to the northeast, a new Zone 3 is proposed to serve new development at higher elevations. The proposed Zone 3 would supply customers between approximately 310 and 440 feet elevation around NE Zimri Drive north of the Allison Inn.

Although initial development in Zone 3 could be independently served by a constant pressure pump station, it is recommended that the City pursue long-term development of a storage reservoir to supply Zone 3 customers by gravity. The proposed reservoir would ultimately serve future customers in the City's largest URA, the North Hills URA, which is anticipated to develop beyond the 20-year planning horizon of this Master Plan.

Customers in the North Hills URA below approximately 440 feet elevation will be served from proposed Zone 3. Customers between approximately 440 and 560 feet are assumed to be served by a future Zone 4. It is assumed that the proposed reservoir will be designed to operate at an HGL to serve future Zone 3 customers by gravity. Future Zone 4 customers would then be served by constant pressure pumping from Zone 3. Zone 4 is anticipated to develop beyond the 20-year planning horizon, thus no further analysis of Zone 4 water service is included in this Plan.

For this analysis, it is assumed that Zone 2 customers will ultimately be served from Zone 3 following construction of the proposed reservoir and necessary transmission piping beyond the 20-year planning horizon.

Storage Capacity Analysis

Storage facilities are provided for three purposes: operational storage, fire storage and emergency storage. As presented in **Section 3**, the total storage required in each pressure zone is the sum of these three elements.

- **Operational Storage** – volume needed to meet peak hour demand (PHD) for 2.5 hours with all non-emergency pumps supplying the zone
- **Fire Storage** – the most severe fire flow requirement in the zone multiplied by the duration of that flow specified in the 2014 *Oregon Fire Code*
- **Emergency Storage** – 100 percent of maximum daily demand (MDD) in the zone

Storage reservoirs must have adequate capacity to meet demands within the pressure zone being supplied by gravity as well as demands in any constant pressure zones pumping out of the gravity zone. In the existing Newberg water system, this means adequate storage must be available in Zone 1 reservoirs to meet storage requirements for Zone 1 customers who are served by gravity and Zone 2 customers who are supplied constant pressure from the Oak Knoll Pump Station. Constant pressure zones, like Zone 2, cannot be adequately supplied fire flow from a lower-elevation reservoir and must have adequate pumping capacity to meet fire flow requirements as presented later in this section. Existing and projected future storage capacity requirements are summarized in **Table 5-1**.

Existing Storage Capacity Findings

Existing Zone 1 storage reservoirs have adequate capacity to meet storage requirements under existing and projected future demand conditions through the 20-year planning horizon.

Proposed Bell Road Reservoir

As discussed earlier in this section, continued development northeast of the City's existing service area will require a new Pressure Zone 3 to serve customers above approximately 310 feet elevation within the UGB and the North Hills URA. The proposed Zone 3 within the UGB would initially be served by constant pressure pumping.

As development warrants beyond the 20-year planning horizon, it is recommended the City construct a new storage reservoir on City-owned property north of Bell Road near the intersection with Zimri Drive. The proposed Bell Road Reservoir will ultimately serve Zone 3 customers within the current UGB, future Zone 3 and 4 customers within the North Hills URA and Zone 2 customers following construction of the proposed reservoir and necessary distribution piping. It is assumed that the proposed Bell Road Reservoir will be designed to operate at an HGL to serve future Zone 3 customers by gravity.

Bell Road Reservoir Capacity

The proposed Bell Road reservoir has an estimated 20-year storage need of approximately 0.24 MG to serve future Zone 3 customers within the UGB. A total storage capacity of 1.69 MG is needed to serve Zone 2 and proposed Zones 3 and 4 beyond the 20-year planning horizon when and if development occurs in the North Hills URA. The total recommended storage capacity for the Bell Road Reservoir is 1.7 MG.

Estimates of proposed Bell Road storage capacity assume a maximum residential fire flow requirement of 1,500 gpm based on potential medium density residential development in future Zones 3 and 4. If the fire flow requirement for the Veritas School in Zone 2 is higher than 1,500 gpm it will impact required storage capacity, adding up to an additional 0.9 MG at a required fire flow of 4,500 gpm which is the maximum requirement from the City's 2015 *Public Works Design and Construction Standards*.

Estimates of proposed Bell Road storage capacity also assume the reservoir will ultimately be supplied by two pump stations, a proposed Bell East Pump Station on Zimri Drive just north of the Allison Inn and a proposed Bell West Pump Station on N College Street near the existing Oak Knoll Pump Station. These proposed pump stations are discussed in more detail in the following paragraphs. It is assumed that the City will re-evaluate the proposed Bell Road Reservoir capacity during reservoir pre-design based on the actual timing and character of development in the UGB and URA.

**Table 5-1
Storage Capacity Analysis**

See Note 1

Pressure Zone	Timeframe	Other Zones Served ¹	Required Storage (MG)				Existing Reservoirs	Existing Storage (MG)	Additional Storage Need (MG)
			Operational	Fire ²	Emergency	Total			
Zone 1	Current	Zone 2	-	1.08	4.79	5.87	North Valley 1 & 2 and Corral Creek	12.00	-
	5-year (2020)		-	1.08	5.70	6.78		12.00	-
	10-year (2025)		-	1.08	6.47	7.55		12.00	-
	20-Year (2035)		-	1.08	7.72	8.80		12.00	-
Zone 3	5-year (2020)	None	-	0.18	0.02	0.20	None	-	0.20
	10-year (2025)		-	0.18	0.05	0.23		-	0.23
	20-Year (2035)		-	0.18	0.06	0.24		-	0.24
	Beyond 20 years	Zone 2 and Zone 4	0.09	0.18	1.42	1.69		-	1.69

Notes:

1. Zone 2 is currently supplied by constant pressure pumping from Zone 1, thus Zone 1 storage must have adequate capacity to serve Zone 2. After construction of the proposed Zone 3 reservoir, assumed to occur beyond the 20-year planning horizon, Zone 2 customers would be served by gravity from the new Zone 3 storage reservoir.
2. Required maximum fire flow for Zone 2 is assumed to be the current 1,000 gpm and proposed Zones 3 and 4 is assumed to be 1,500 gpm. If the fire flow requirement for the Veritas School or other structures in these future zones is determined to be larger than 1,500 gpm it will impact the storage needed up to an additional 0.9 MG with a required flow of 4,500 gpm. This is the maximum requirement from the City's 2015 *Public Works Design and Construction Standards*.

**Table 5-2
Pumping Capacity Analysis**

See Note 1

Pressure Zone	Timeframe	Other Zones Served	Criteria	Req'd Firm Capacity (gpm)	Existing Pumps	Firm Capacity (gpm)	
						Existing	Additional Need
Zone 1	Current	Zone 2	MDD	3,327	WTP High Service	6,900	-
	5-year (2020)	Zone 2 & Zone 3		3,972			-
	10-year (2025)			4,528			-
	20-Year (2035)			5,403			-
Zone 2	Current	-	PHD + Fire Flow ²	1,049	Oak Knoll	260	789
	5-year (2020)			1,639			1,379
	10-year (2025)			1,639			1,379
	20-Year (2035)			1,639			1,379
	Beyond 20 years	MDD	375	None ¹	-	375	
Zone 3	5-year (2020)	-	PHD + Fire Flow	1,521	None	-	1,521
	10-year (2025)			1,562			1,562
	20-Year (2035)			1,569			1,569
	Beyond 20 years	Zone 4	MDD	612			612

Notes:

- Existing Oak Knoll Pump Station is assumed to be abandoned following construction of proposed Bell West Pump Station to serve Zone 2 and ultimately proposed Bell Road Reservoir.
- Required maximum fire flow for Zone 2 is assumed to be the current 1,000 gpm requirement. If the fire flow requirement for the Veritas School or other structures included in the Zone 2 north expansion is determined to be larger than the current 1,000 gpm requirement, it will impact the firm pumping capacity needed within the 20-year timeframe up to an additional 3,500 gpm with a total required flow of 4,500 gpm. This is the maximum requirement from the City's 2015 *Public Works Design and Construction Standards*.

Note 1: See Appendix E, Addendum Riverfront Master Plan (Adopted 5/3/21)

Pumping Capacity Analysis

Pumping capacity requirements are estimated based on available storage, the number and size of pumps serving each pressure zone and the zone's maximum fire flow requirement. Recommendations are based on firm capacity which is defined as a pump station's capacity with the largest pump out of service, measured in gallons per minute (gpm).

In pressure zones supplied by gravity, like Zone 1, operational and fire storage provided by reservoirs make it unnecessary to plan for fire flow or peak hour capacity from pump stations, assuming adequate storage is available. Pump stations supplying gravity zones must have sufficient firm capacity to meet the maximum day demand for all customers in the zone and any higher zones supplied from the primary zone.

Constant pressure pump stations supply a pressure zone without the benefit of storage, like Zone 2. Zones served by constant pressure pumping present a higher level of risk for water providers as a total loss of service pressure could occur with a power outage or main break in the zone. This loss of pressure temporarily leaves customers without water in their homes or for fire suppression and may result in a boil water advisory. However, constant pressure stations may be the only cost-effective way to serve some areas in the distribution system which would otherwise require an elevated reservoir to provide pressure by gravity. Due to these potential risks, these stations are only recommended for areas with few services and low water demand. Pump stations supplying constant pressure service must have firm pumping capacity to meet peak hour demands while simultaneously supplying the largest fire flow demand in the zone. The pumping capacity analysis is summarized in **Table 5-2**.

**Table 5-2
Pumping Capacity Analysis**

Pressure Zone	Timeframe	Other Zones Served	Criteria	Req'd Firm Capacity (gpm)	Existing Pumps	Firm Capacity (gpm)	
						Existing	Additional Need
Zone 1	Current	Zone 2	MDD	3,327	WTP High Service	6,900	-
	5-year (2020)	Zone 2 & Zone 3		3,972			-
	10-year (2025)			4,528			-
	20-Year (2035)			5,403			-
Zone 2	Current	-	PHD + Fire Flow ²	1,049	Oak Knoll	260	789
	5-year (2020)			1,639			1,379
	10-year (2025)			1,639			1,379
	20-Year (2035)			1,639			1,379
	Beyond 20 years	MDD	375	None ¹	-	375	
Zone 3	5-year (2020)	-	PHD + Fire Flow	1,521	None	-	1,521
	10-year (2025)			1,562			1,562
	20-Year (2035)			1,569			1,569
	Beyond 20 years	Zone 4	MDD	612			612

Notes:

- Existing Oak Knoll Pump Station is assumed to be abandoned following construction of proposed Bell West Pump Station to serve Zone 2 and ultimately proposed Bell Road Reservoir.
- Required maximum fire flow for Zone 2 is assumed to be the current 1,000 gpm requirement. If the fire flow requirement for the Veritas School or other structures included in the Zone 2 north expansion is determined to be larger than the current 1,000 gpm requirement, it will impact the firm pumping capacity needed within the 20-year timeframe up to an additional 3,500 gpm with a total required flow of 4,500 gpm. This is the maximum requirement from the City's 2015 *Public Works Design and Construction Standards*.

Existing Pumping Capacity Findings

The existing Water Treatment Plant (WTP) High Service Pumps have adequate capacity to supply projected system-wide demands through the 20-year planning horizon. The Oak Knoll Pump Station, serving Zone 2, is not currently equipped with a redundant high capacity pump to meet fire flow demands. The station's existing high capacity pump is sized for a flow of 1,000 gpm.

Proposed Pump Stations

To supply future customers at higher elevations north of the City's existing service area additional high elevation pressure zones are needed. Development in these areas is anticipated to be incremental with many new customers connecting to the City water system beyond the 20-year planning horizon from new development in the North Hills URA. Thus, a phased approach to pumping and storage facilities is needed to provide water service while distributing capital improvement costs and maintaining adequate water circulation for water quality throughout the system. It is recommended that high elevation service areas initially be served by constant pressure pump stations, transitioning to gravity service following construction of the proposed Bell Road Reservoir beyond the 20-year planning horizon.

Bell East Pump Station

For the purposes of this Master Plan it is assumed that Zone 3 development within the UGB will be served by constant pressure pumping from the proposed Bell East Pump Station through the 20-year planning horizon.

Concurrent with construction of the Bell Road Reservoir, Bell East Pump Station will be modified to supply the reservoir which will then serve customers by gravity. The proposed pump station, located on Zimri Drive just north of the Allison Inn will draw suction supply from existing 24-inch diameter Zone 1 distribution mains on Zimri Drive.

Bell East Capacity

As shown in **Table 5-2**, Bell East has a proposed firm capacity of approximately 1,600 gpm through the 20-year planning horizon to provide PHD and residential fire flow to future Zone 3 customers within the UGB.

Following construction of the Bell Road Reservoir beyond 20 years, Bell East Pump Station would need a firm capacity of approximately 700 gpm to fill the reservoir at a rate approximately equal to the MDD for future Zone 3 and 4 customers within the UGB and North Hills URA.

Bell West Pump Station

The proposed Bell West Pump Station will serve existing Zone 2 customers and the Zone 2 expansion to the Veritas School by constant pressure pumping through the 20-year planning horizon. It is anticipated the existing Oak Knoll Pump Station will be abandoned following construction of Bell West.

Following construction of the Bell Road Reservoir and approximately 6,000 linear feet (1.1 miles) of transmission main along Bell Road between Zimri Drive and N College Street, Bell West Pump Station will be modified to supply the reservoir which will then serve former Zone 2 customers by gravity. The proposed pump station, located on N College Street near the Madison Drive alignment will draw suction supply from 18-inch diameter Zone 1 mains supplying the North Valley Reservoirs at N College Street and N Terrace Drive.

Bell West Capacity

As shown in **Table 5-2**, Bell West has a proposed firm capacity of approximately 1,400 gpm through the 20-year planning horizon to provide PHD and a residential 1,000 gpm fire flow to Zone 2 including expansion to the Veritas School. If the fire flow requirement for the Veritas School in Zone 2 is higher than 1,000 gpm it will impact required pumping capacity, adding up to an additional 3,500 gpm.

Following construction of the Bell Road Reservoir beyond 20 years, Bell West Pump Station will need a firm capacity of approximately 400 gpm to fill the reservoir at a rate approximately equal to the projected MDD for Zone 2.

Back-Up Power

At least two independent power sources are recommended for the City's pump stations. It is recommended that pump stations supplying gravity storage reservoirs include, at a minimum, manual transfer switches and connections for a portable back-up generator. The emergency storage volume in each reservoir will provide short term water service reliability in case of a power outage at the pump station. Back-up power is particularly critical for stations which provide constant pressure service. On-site standby power generators with automatic transfer switches are recommended for constant pressure pump stations serving zones without the benefit of gravity storage.

An on-site back-up power generator is installed at the existing WTP which is capable of operating the high level pumps to fill Zone 1 reservoirs. The existing Oak Knoll Pump Station also has a back-up power generator.

It is recommended that proposed Bell East and Bell West Pump Stations have back-up power generators incorporated into their design.

Distribution Capacity and Hydraulic Performance

Hydraulic Model

A steady-state hydraulic network analysis model was used to evaluate the performance of the City's existing distribution system and identify proposed piping improvements based on hydraulic performance criteria, such as system pressure and flow velocity, described in **Section 3**. The purpose of the model is to determine pressure and flow relationships throughout the distribution system for average and peak water demands under existing and projected future conditions. Modeled pipes are shown as "links" between "nodes" which represent pipeline junctions or pipe size changes. Diameter, length and head loss coefficients are specified for each pipe and an approximate ground elevation is specified for each node.

The hydraulic model was developed for this Master Plan using the InfoWater modeling software platform with geographic information system (GIS) base mapping and operations data provided by the City. The model was calibrated using fire hydrant flow test data and analysis scenarios were created to evaluate existing and projected 20-year demands.

For distribution system modeling, the City's WTP High Service Pumps are assumed to be off. Zone 1 storage reservoirs are modeled approximately two-thirds full under peak demand conditions based on input from City staff regarding summertime operating levels.

Modeled Water Demands

Existing and projected future demands are summarized in **Section 2, Tables 2-2 and 2-4**. Within the existing water service area, demands are assigned to the model based on current customer billing address and billed water consumption. Future demands in water service expansion areas are assigned uniformly over each proposed pressure zone area illustrated on the water system maps in **Appendix A**.

Model Calibration

Model calibration typically involves adjusting the model parameters such that pressure and flow results from the model more closely reflect those measured at the City's fire hydrants. This calibration process tests the accuracy of model pipeline friction factors, demand distribution, valve status, network configuration, and facility parameters such as tank elevations and pump curves. The required level of model accuracy can vary according to the intended use of the model, the type and size of water system, the available data, and the way the system is controlled and operated. Pressure and flow measurements are recorded for the City's fire hydrants through a process called fire flow testing.

Fire Flow Testing

Fire flow testing consists of recording static pressure at a fire hydrant and then "stressing" the system by flowing an adjacent hydrant. While the adjacent hydrant is flowing, residual

pressure is measured at the first hydrant to determine the pressure drop that occurs when the system is “stressed”. Boundary condition data, such as reservoir levels and pump on/off status, must also be known to accurately model the system conditions during the time of the flow test. For this Master Plan, hydrant flow tests were conducted on April 6, 2016. The recorded time of each fire hydrant flow test was used to collect boundary condition information from the City’s supervisory control and data acquisition (SCADA) system.

Steady-State Calibration Results

For any water system, a portion of the data describing the distribution system will be missing or inaccurate and assumptions will be required. This does not necessarily mean the accuracy of the hydraulic model will be compromised. Depending on the accuracy and completeness of the available information, some pressure zones may achieve a higher degree of calibration than others. Models that do not meet the highest degree of calibration can still be useful for planning purposes.

Pump discharge flow and pump curves were not available for the Oak Knoll Pump Station, serving the City’s Pressure Zone 2 through constant pressure pumping. The absence of accurate flow data for constant pressure zones makes it difficult to accurately model the Oak Knoll Pump Station. Flows were approximated based on the assigned demands in the model, City-provided pump nominal capacities and discharge pressure measured at the station.

The model calibration’s confidence level was evaluated based on the difference between modeled and field-measured pressure drops during fire hydrant flow testing, in pounds per square inch (psi), as summarized in **Table 5-3**. Overall system calibration confidence is considered high.

**Table 5-3
Calibration Confidence**

Confidence Level	Field-Measured vs. Modeled Pressure Drop Difference
High	+5 psi
Medium	+5-10 psi
Low	>10 psi

Fire Flow Analysis

Fire flow scenarios test the distribution system’s ability to provide required fire flows at a given location while simultaneously supplying MDD and maintaining a minimum residual service pressure of 20 psi at all services. Required fire flows are assigned based on the zoning surrounding each hydrant as summarized in **Section 3, Table 3-1**.

The City's existing distribution mains are well looped with adequate fire flows available in most areas and relatively few piping improvements recommended for fire flow. Piping improvements are primarily needed in older parts of the water system including smaller diameter water mains adjacent to George Fox University and undersized 1- and 2-inch mains with few interconnections serving E Hancock Street (Highway 99W) between N Grant and N Edwards Streets downtown.

Peak Hour Demand Analysis

Distribution system pressures were evaluated under peak hour demand conditions to confirm identified piping improvements. Peak hour demands were estimated as 1.7 times the maximum day demand. No additional pressure deficiencies were identified under these conditions.

Distribution System Water Quality

The City of Newberg meets all current drinking water quality regulations. This analysis focuses on microbial contaminants (Total Coliform Rule), lead and copper (Lead and Copper Rule) and disinfection by-products (Stage 2 Disinfectants and Disinfection Byproducts Rule) which may be exacerbated or originate in the distribution system.

Total Coliform Rule Compliance

The City is currently meeting all applicable requirements for the Total Coliform Rule. It is important to maintain active circulation of water throughout the distribution system, in both pipes and reservoirs in order to retain a chlorine residual. The absence of chlorine residual and accumulation of sediments contribute to bacterial growth, which in turn can result in failure to comply with this rule.

Lead and Copper Rule Compliance

The City uses caustic soda to raise the pH of treated water leaving the WTP. Newberg has been in compliance with the Lead and Copper Rule since 1997 when this pH adjustment system was installed. There appear to be no concerns with future compliance with the Lead and Copper Rule.

Stage 2 Disinfectants and Disinfection Byproducts Rule (D/DBPR) Compliance

Currently, the City conducts quarterly sampling for DBP at the following four sample sites, all of which are currently in compliance:

- North Valley Reservoirs (25600 North Valley Road)
- Corral Creek Reservoir (31451 Corral Creek Road)
- 3743 Dahlia Street
- 210 The Greens

Summary

This section presented an analysis of the City of Newberg's water distribution system based on projected future water demands presented in **Section 2** and performance criteria outlined in **Section 3**. This water system assessment includes service pressures and zone boundaries, storage and pumping capacity and emergency fire flow availability. This section provides the basis for recommended distribution system improvements presented in **Section 7** Capital Improvement Program.



SECTION 6 OPERATIONS AND MAINTENANCE

This section assesses the City of Newberg's (City's) Operations and Maintenance (O&M) program for its water system. The assessment is based on information from City staff compared with American Water Works Association (AWWA) standards, the O&M practices of similarly sized utilities, and pertinent regulatory requirements. Recommendations for improvements to the City's O&M program, described at the end of this section, are based on the results of this assessment.

Existing O&M Structure

The City's Public Works Department staff are responsible for the maintenance and operation of the water distribution and treatment systems. Newberg Public Works is structured into three major divisions; Operations, Maintenance, and Engineering. This section focuses on the work of the Operations and Maintenance divisions. Within these divisions staff are charged with O&M for a variety of public facilities including both water and wastewater utilities, fleet maintenance, street repair and grounds maintenance. This generalized structure allows staff to support multiple facilities and for administrative functions to be shared across utilities. Water utility responsibilities for each division are as follows:

Operations Division

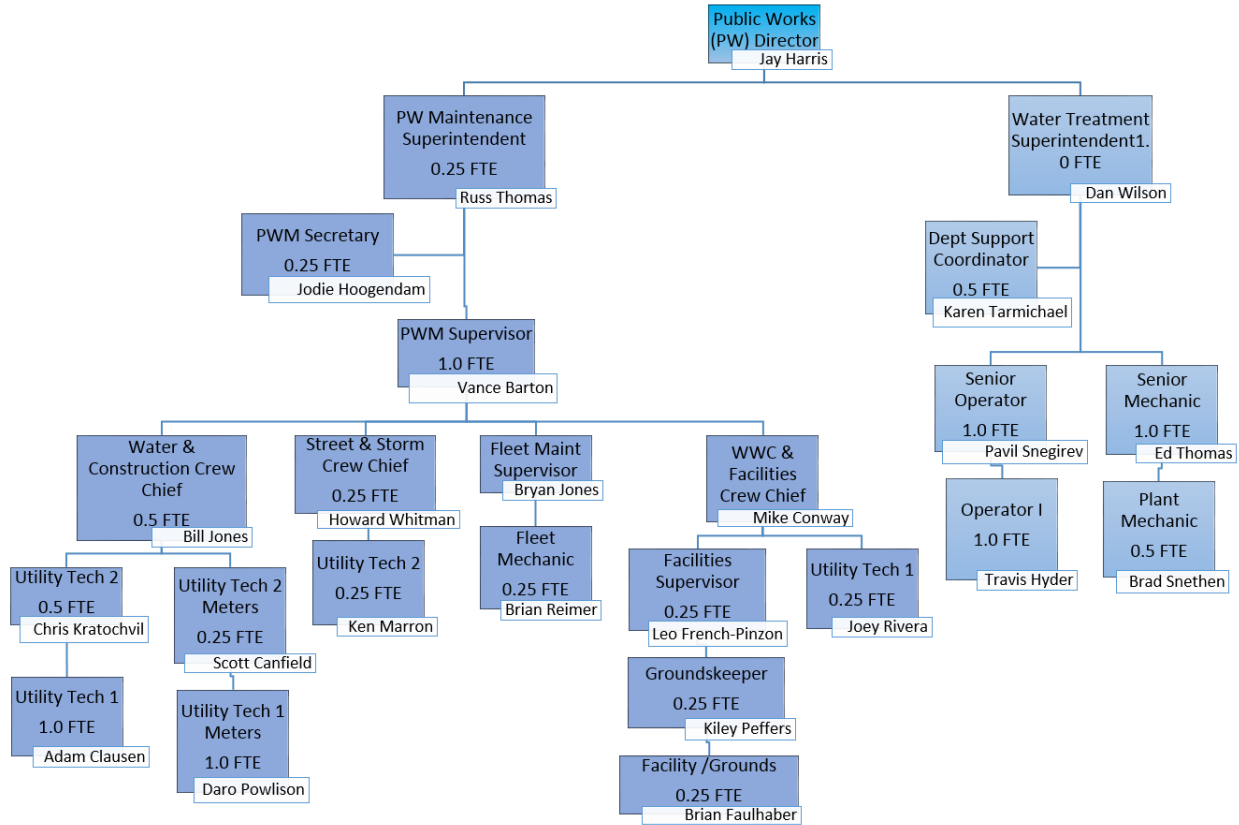
- Water Treatment Plant
- Well field
- Storage reservoirs
- Pump stations

Maintenance Division

- Distribution main flushing & repair
- Valves & hydrants
- Meter reading
- Investigate & address customer complaints

The water utility has budgeted staff time of 5 full-time equivalent employees (FTEs) from the Operations Division and 6.5 FTEs from the Maintenance Division. **Figure 6-1** shows the organizational structure for O&M staff whose time is allocated to the water system. The City is currently evaluating the Maintenance Division organizational structure. Anticipated changes include a move towards more defined crews for each utility rather than, for instance, a general public works construction crew.

Figure 6-1 Water Utility Public Works Staff FTE



O&M Regulations and Guidelines

Oregon Administrative Rules (OAR) 333-061-0065 govern O&M of public water systems with the primary directive that they be “operated and maintained in a manner that assures continuous production and distribution of potable water”. These rules establish general requirements for leak repair, proper and functioning equipment, emergency planning, and current documentation.

The AWWA G200 Distribution Systems Operation and Management standard provides recommendations for routine maintenance programs, handling customer complaints, and record keeping which address the O&M goals and requirements of the OAR.

The City has also established ordinances regarding connection to the water system, cross-connection, backflow prevention, and water conservation and curtailment as described in Newberg Municipal Code Chapter 13.15.

Operator Certification

OAR 333-061-0200 defines requirements for water system operator certification. Personnel in charge of operations for all community water systems, like Newberg’s water system, are required to be certified through the Oregon Water System Operator’s Certification Program. Water distribution and water treatment operators must receive certification in accordance with the classification of the system they operate. The City’s classifications are:

- **Water Treatment 2** – based on the complexity of water treatment required
- **Water Distribution 3** - based on a service area population between 15,000 and 50,000 people, Newberg’s service population is approximately 22,900

State guidelines also require water suppliers to identify an operator with these levels of certification as being in “direct responsible charge” (DRC) of the treatment and distribution systems. In Newberg, these roles are filled by the Water Treatment Superintendent and the Maintenance Superintendent respectively. **Table 6-1** summarizes current Oregon water operator certification levels held by Newberg public works staff.

**Table 6-1
Certification Status of Personnel**

Certification Number	Name	Job Title	Certification
D-5076, T-5076	Dan Wilson	Water Treatment Superintendent / Cross Connection Specialist – DRC treatment	WD-2, WT-3
D-08243, T-08150	Pavil Snegirev	Senior Water Treatment Operator	WD-3, WT-3
D-1533	Russ Thomas	Maintenance Superintendent – DRC distribution	WD-3
D-6191	Vance Barton	Maintenance Supervisor	WD-3
D-6283	Michael Conway	Facilities & Field Ops Lead/Crew Chief	WD-2
D-6021	Scott Canfield	Maint Tech 2 – Cartograph / Meter Service	WD-2
D-08442	Chris Kratochvil	Maint Tech 1	WD-2

Current O&M Practices and Procedures

Both the Operations and Maintenance divisions implement procedures to ensure that the water system facilities function efficiently and meet level-of-service requirements (e.g., water quality and adequate service pressure). Routine procedures include visual inspection of system facilities, monitoring flow- and reservoir-level recording, and responding to customer inquiries and complaints. City staff handle the majority of O&M duties; however, tasks such as major water main repairs, well rehabilitation and reservoir painting are sourced to outside contractors.

System Operation

The City maintains and operates all facilities and appurtenances within the system, including customer meters. The customer is responsible for maintaining the water service line beyond the meter, typically located at the curb or near the property line. Meter reading is performed using a mobile Automatic Meter Reading (AMR) system and requires approximately 16 staff hours monthly to complete.

Each facility is typically inspected one to two times weekly to ensure security, proper operation and site maintenance. Chlorine residual and water pH in each finished water storage reservoir are checked twice a week. Well water levels are hand measured bi-monthly to verify well level indicators are reading accurately.

Field personnel monitor the water system's performance every day. Supervisory Control and Data Acquisition (SCADA) equipment at the City's the Water Treatment Plant (WTP) records the water pressure and metered flow at all wells, pressure at the Oak Knoll booster pump station, and water levels in the City's finished water storage reservoirs and WTP clearwell. Flow out of the WTP to distribution mains and storage reservoirs is recorded at the High Service Pumps. The volume of water produced at the WTP is totaled and recorded. Water personnel can use this data to detect any major abnormalities in the water system.

Water quality monitoring, as described in **Section 5**, is also performed by operations staff.

System Preventive Maintenance

The City's current preventive maintenance program consists of regularly servicing pumps and flushing water mains.

The City's water system includes well pumps, finished-water High Service Pumps at the WTP, raw water pumps at Otis Springs and booster pumps at the Oak Knoll Pump Station. Annual pump maintenance activities at one or more pump stations include:

- Clean variable frequency drives (VFDs)
- Test well pump output

- Test flow meters
- Change pump motor oil
- Inspect and, if needed, replace impellers
- Clean pump screens
- Fire pump testing (monthly)

Flushing is currently performed annually during the low demand winter season for a portion of the distribution system. With this annual flushing, the entire system is flushed on an approximately 4- to 5-year rotation. Dead ends are flushed every one to two years. Local flushing is also performed, as needed, in response to customer complaints.

The City does not currently have a formal valve exercising or hydrant maintenance program. Valves and hydrants are checked during flushing. Hydrants are repainted every 5 to 8 years using seasonal labor.

Other maintenance activities regularly performed by City staff include:

- Maintain grounds around City facilities
- Address customer complaints
- Exercising valves at system reservoirs, wells and pump stations
- Sodium hypochlorite generation cell service at WTP (semi-annually)
- Polymer pump maintenance
- Checking for leaks in bridge-mounted raw water transmission main

Record Keeping

Current water system mapping is maintained by the Engineering Division using Geographic Information Systems (GIS). Public Works Maintenance staff have access to view current mapping electronically. All mapping changes are processed by the Engineering Division's GIS Analyst based on paper mark-ups or as-builts provided by Maintenance.

The City manages water system assets using Cartegraph software. Cartegraph is used to record customer complaints and generate work orders for repair and maintenance activities. The current software will no longer be updated in 2017, and support will end in 2018. City staff are investigating options to update or convert to another asset management system.

Customer Complaints

Customers may call or email to file a complaint with any member of City staff. The initial contact forwards the complaint to the correct department and, depending on the nature of the complaint, it is investigated immediately to several days later. Complaints are addressed in the order of their severity and major issues are recorded in the City's current asset management software.

Conclusions and Recommendations

An effective O&M program addresses issues with customer interaction, water quality and infrastructure operations and maintenance. The City's current O&M program does not include some common best management practices of water utilities in the region. The City is currently evaluating water maintenance programs and assessing the need for additional routine maintenance.

Distribution System

Water distribution system O&M programs typically include the following maintenance programs:

- Dead-end main and hydrant flushing.
- Valve exercising.
- Leak detection.

It is difficult for water providers to address each item listed above. Consequently, it is important to prioritize maintenance of the critical infrastructures necessary to maintain effective service during an emergency. To accomplish this, the City should ensure adequate resources. Currently the City is completing dead-end main and hydrant flushing on a routine basis, and based on the limited number of water quality complaints and observed performance of hydrants during flow testing for this Master Plan, changes to the City's hydrant flushing program are not recommended.

To maintain a high level of service, the City should assess and identify critical components of the distribution system. To improve water distribution system O&M, it is recommended that the City develop the following programs:

1. A pipe replacement program based on a 100-year cycle as presented in **Section 5**.
2. A valve exercising program that operates all distribution valves on a 5-year basis to maintain the reliability of their service. If properly operated, most valves require less maintenance and will last a long time. Focus should be on critical isolation valves within the distribution system.
3. A leak-detection program may provide value to the City. At this point, the City is unable to perform an accurate comparison of water production and consumption to quantify water losses, thus, the value of a leak detection program is unclear. The City should invest in resolving this data discrepancy to determine if investment in leak detection is warranted. Typically, a leak detection program will provide value for systems with water loss rates in excess of 10 percent of annual water production.

Water Storage Tanks

To ensure a long tank life and good water quality, water storage tanks must be periodically inspected and maintained at least every five years, depending on the structure. Routine inspections aid in assessing the coating system and potential required repairs.

The following recommendations will allow the City to expand its water system maintenance program and improve its water storage tank operations and maintenance program:

4. Implement a water storage tank inspection and cleaning program to assess every storage tank within the system every 5 years. The City could consider contracting with an independent certified inspection company.

Staffing

The implementation of any of the recommendations presented above will result in a need for evaluation of staffing levels within the Maintenance department. In particular, staff availability to increase time dedicated to the water utility relative to other utility requirements will need to be considered.

SECTION 7

RECOMMENDATIONS AND CAPITAL IMPROVEMENT PROGRAM (CIP)

This section presents recommended improvements and capital maintenance for the City of Newberg's (City's) water system based on the analysis and findings presented in **Sections 4 and 5**. These improvements include supply, storage reservoir, pump station and water main projects. The capital improvement program (CIP) presented in **Table 7-5** later in this section summarizes recommended improvements and provides an approximate timeframe for each project. Proposed supply and distribution system improvements are illustrated on **Plate 1** in **Appendix A**.

Cost Estimating Data

An estimated project cost has been developed for each improvement project recommended in this section. Cost estimates represent opinions of cost only, acknowledging that final costs of individual projects will vary depending on actual labor and material costs, market conditions for construction, regulatory factors, final project scope, project schedule and other factors. The Association for the Advancement of Cost Engineering International (AACE) classifies cost estimates depending on project definition, end usage and other factors. The cost estimates presented here are considered Class 4 with an end use being a study or feasibility evaluation and an expected accuracy range of -30 percent to +50 percent. As the project is better defined, the accuracy level of the estimates can be narrowed.

Estimated project costs are based upon recent experience with construction costs for similar work in Oregon and southwest Washington and assume improvements will be accomplished by private contractors. Estimated project costs include approximate construction costs and an aggregate 44 percent allowance for administrative, engineering and other project related costs. Estimates do not include the cost of property acquisition. Since construction costs change periodically, an indexing method to adjust present estimates in the future is useful. The Engineering News-Record (ENR) Construction Cost Index (CCI) is a commonly used index for this purpose. For purposes of future cost estimate updating; the current ENR CCI for Seattle, Washington is 10623 (October 2016).

Water System Capital Improvement Program

See Note 2

A summary of all recommended improvement projects and estimated project costs is presented in **Table 7-5**. This CIP table provides for project sequencing by showing prioritized projects for the 5-year, 10-year and 20-year timeframes defined as follows:

- 5-year timeframe - recommended completion before 2022
- 10-year timeframe - recommended completion between 2022 and 2027
- 20-year timeframe - recommended completion between 2027 and 2037.

CIP Cost Allocation to Growth

See Note 2

Water system improvement projects are recommended to mitigate existing system deficiencies and to provide capacity to accommodate growth and service area expansion. Projects that benefit future water system customers by providing capacity for growth may be funded through system development charges (SDCs). To facilitate this SDC evaluation a preliminary percentage of the cost of each project which benefits future water system growth is allocated in the CIP table. The basis for percentages allocated to growth are described later in this section for each recommended facility and summarized in the CIP **Table 7-5**.

Projects such as water supply improvements are considered water system performance improvements which benefit all existing and future customers. The estimated costs of these improvements are allocated 44 percent to future growth based on the ratio of current to projected future system-wide maximum day demands (MDD) beyond 20 years including the City's Urban Growth Boundary (UGB) and North Hills Urban Reserve Area (URA).

Supply

See Note 2

Redundant Supply

As presented in **Section 4**, it is recommended that the City pursue development of a redundant water supply to address existing supply vulnerability and for long-term water system resiliency. The proposed redundant source is a new alluvial-aquifer well in the Gearn's Ferry area on the north side of the Willamette River near the current Highway 219 bridge crossing.

The redundant supply, with an approximate capacity of 2 million gallons per day (mgd), would consist of a new groundwater well, on-site treatment for iron and manganese, on-site disinfection and approximately 1.3 miles of 12-inch diameter transmission mains from the new well to existing distribution at Highway 219 and NE Wyooski Road. Estimated project costs for supply development also include water rights permitting as well as geophysical and water quality exploration of the area to identify feasible well sites. It is assumed that exploration and supply development will take place over the next 10 years.

Although a new well in the Gearn's Ferry area appears to be the most feasible option for redundant supply currently, it is anticipated that the City will evaluate other source water options as opportunities arise.

Treatment

The City currently uses sodium hypochlorite for disinfection at the Water Treatment Plant (WTP). The existing hypochlorite generator is showing signs of deterioration, such as, warped cell plates. City staff previously identified the need to replace the existing hypochlorite generator with new equipment. This improvement is expected to occur in the next two years.

Storage Reservoir

Based on projected future storage capacity deficiency presented in **Section 5, Table 5-1**, a new finished-water storage reservoir is recommended to serve future Zone 3 customers within the UGB. The proposed Bell Road Reservoir (CIP No. R-1) will ultimately serve Zone 2 and proposed Zones 3 and 4 beyond the 20-year planning horizon when and if development occurs in the North Hills URA. The proposed 1.7 million gallon (MG) reservoir is recommended for construction beyond 20-years. It is anticipated that the City will begin reservoir design within the 20-year timeframe. A portion of the estimated project cost is allocated to the 20-year timeframe in CIP **Table 7-5** based on the ratio of storage capacity needed to meet 20-year projected demands (0.24 MG) and the ultimate 1.7 MG recommended capacity.

Pump Stations

Based on the pumping capacity analysis presented in **Section 5, Table 5-2**, two new pump stations, Bell East (CIP No. P-1) and Bell West (CIP No. P2) are recommended to supply future Zone 3 and Zone 2 customers respectively. In the short term, both pump stations would supply constant pressure service to a small number of customers too high in elevation to be supplied by existing Zone 1. Following completion of the proposed Bell Road Reservoir (CIP No. R-1) and related transmission mains beyond the 20-year planning horizon, both stations would be converted to supply the reservoir.

The Bell West Pump Station is recommended for construction within the 5-year timeframe and Bell East within the 10-year timeframe. The Bell West Pump Station is needed to supply adequate fire flow to the Zone 2 expansion to Veritas School if the fire flow requirement at the school is determined to be greater than the existing 1,000 gallons per minute (gpm) available from the Oak Knoll Pump Station. The Bell East Pump Station will be needed as development occurs within the UGB along Zimri Drive north of the Allison Inn.

Distribution Mains

Table 7-2 and **7-3** present recommended water main projects for fire flow capacity and system expansion respectively. All recommended water main projects are illustrated on **Plate 1** in **Appendix A**.

Distribution Main Cost Estimates

Water main project costs are estimated based on unit costs by diameter shown in **Table 7-1**.

Table 7-1
Unit Cost for Water Main Projects

Pipe Diameter	Cost per Linear Foot (\$/LF)
8-inch	\$245
12-inch	\$290
18-inch	\$360

Assumptions:

1. Includes approximately 45 percent allowance for administrative, engineering and other project related costs
2. Ductile iron pipe with an allowance for fittings, valves and services
3. Surface restoration is assumed to be asphalt paving
4. No rock excavation
5. No dewatering
6. No property or easement acquisitions
7. No specialty construction included

Distribution Main Improvements for Fire Flow (M-1 to M-8, M-18)

As presented in **Section 5**, analysis using the City's water system hydraulic model revealed few piping improvements are needed to provide sufficient fire flow capacity and adequate service pressure within the existing water service area under existing and projected future demand conditions. Water main projects M-1 to M-8 and M-18 are recommended to address fire flow deficiencies under existing conditions. Project M-1 is recommended to replace several non-looped sections of 1- and 2-inch diameter mains along Hancock Street/Highway 99W through downtown Newberg. Several fire flow deficiencies and inadequate fire hydrant spacing and coverage were identified in this area. Water main improvements for fire flow are recommended for completion within the 5-year timeframe.

Estimated costs for these Zone 1 water main projects are allocated 34 percent to future growth based on the ratio of current to projected future Zone 1 MDD beyond 20 years including the City's UGB and North Hills URA.

**Table 7-2
Distribution Main Improvements for Fire Flow**

Project No.	Location	Diameter (inches)	Length (LF)	Estimated Project Cost
M-1	Downtown - Hancock St/Highway 99W from N Grant to Edwards St interconnect with existing side street mains, abandon existing 1-inch and 2-inch mains	8	2,250	\$552,000
M-2	NE Dayton Ave from W Johanna Ct south to existing hydrant – upsize 4-inch	8	410	\$101,000
M-3	Mission Dr from N College St west to existing hydrant at Mission Ct - upsize 6-in	8	940	\$231,000
M-4	Vittoria Square Apartments - Vittoria Way to Aquarius Blvd - upsize 4-inch	8	600	\$147,000
M-5	141 N Elliott Rd - upsize 6-inch fire line and loop with Highway 219	8	640	\$157,000
M-6	E North and Sherman Streets west of Villa Rd surrounding George Fox University Roberts Center and residence halls - upsize 4- and 6-inch mains	8	1,410	\$346,000
	East of Roberts Hall between E North and Sherman Streets - new 8-inch main loop			
M-7	South of Mountainview Dr between N Alice Way and Esther - upsize 6-inch	12	590	\$ 172,000
M-8	Wynooski Rd to Wastewater Treatment Plant hydrant	12	330	\$ 96,000
M-18	W Illinois St/Highwy 240, existing dead end near N Morton St to NE Chehalem Dr	8	832	\$ 400,000
Total Main Improvements for Fire Flow				\$ 2,202,000

Projects for Future System Expansion (M-9, M-14 to M-17, M-19)

Existing distribution main extensions and large diameter loops will be needed to serve new development areas within the City's UGB and North Hills URA including:

- Proposed Zone 3 water service within the UGB along NE Zimri Dr north of the Allison Inn (CIP No. M-9)
- Suction and discharge piping for proposed Bell West Pump Station (CIP No. P-2) to supply Zone 2 expansion north to Veritas School (CIP No. M-14 and M-15)
- Supply to proposed Bell Road Reservoir (CIP No. R-1) from Bell East and Bell West Pump Stations (CIP Nos. M-16 and M-17)
- Chehalem Drive water system extension (CIP No. M-19). This water main project was previously identified by the City to extend City water service from W Illinois/Hwy 240 north on NE Chehalem Drive to Columbia Drive.

Although many of these piping improvements will be constructed only as development warrants it is prudent for the City to have a long-term plan which sizes proposed facilities for the ultimate anticipated capacity need.

**Table 7-3
Distribution Main Improvements for System Expansion**

Project No.	Location	Diameter (inches)	Length (LF)	Estimated Project Cost	Timeframe
M-9	NE Zimri Drive from proposed Bell East PS (P-1) north to UGB	18	960	\$ 346,000	5-year
M-14	N College St from N Terrace Ct to proposed Bell West Pump Station (P-2)	12	830	\$ 241,000	5-year
M-15	N College St from proposed Bell West PS (P-2) to Veritas School	12	660	\$ 192,000	5-year
M-16	Bell East PS (P-1) to Bell Road Reservoir (R-1)	18	5,130	\$1,847,000	20-year and beyond
M-17	Bell West PS (P-2) to Bell Road Reservoir (R-1)	12	5,950	\$1,726,000	20-year and beyond
M-19	Chehalem Drive water system extension to Columbia Drive	8		\$600,000	5-year
Total Main Improvements for System Expansion				\$4,952,000	

Routine Main Replacement Program

In addition to distribution main projects to address capacity deficiencies and growth, the City should plan for routine replacement of pipes less than 6-inch diameter and aging pipes based on a 100-year life cycle. The goal of a routine pipe replacement program is to maintain reliable operation, without significant unexpected main breaks and leaks. Dead-end water mains under 6-inch diameter and less than 300 feet long with no fire hydrants are not recommended for replacement solely based on their diameter. **Figure 7-1** at the end of this section illustrates existing mains recommended for replacement within the 20-year planning horizon. Mains are assigned a first, second or third replacement priority based on the following:

- **Priority 1 Small and old** - mains both under 6-inch dia. and installed prior to 1936
- **Priority 2 Small** - mains under 6-inch diameter
- **Priority 3 Old** - mains installed prior to 1936

Table 7-4 summarizes the 20-year recommended pipe replacement program including total length of pipe for each diameter (size), the replacement diameter and estimated cost to replace. While costs will vary for each individual main depending on the piping location, surface conditions, and other constructability issues, this analysis provides a preliminary estimate of the required capital budget to execute an effective and proactive water main replacement program.

The average annual cost for the first 20 years of a 100-year replacement program is approximately \$736,000 annually. While it is understood that funding at this level for pipeline replacement may not be feasible today, it should be recognized that an adequately funded main replacement program is necessary to minimize the risk of failure for critical water system components that will result in significantly greater costs to repair and replace in the future. The routine main replacement cost included in the proposed CIP **Table 7-5** is the level of funding City staff determined to be available annually for this program.

**Table 7-4
20-Year Distribution Main Replacement Cost Summary**

Diameter (in)	Approx. Length (feet)	Replacement Diameter (in)	Estimated Replacement Cost
Less than 2	3,200	8	\$ 11,137,000
2	7,100		
4	13,900		
6	15,400		
8	5,800		
10	9,200	12	\$ 3,560,000
12	3,100		
18	60	18	\$ 21,000
Total Length	57,760	Total Cost	\$ 14,718,000

Planning Studies and Facility Assessments

Based on recent ground movement around the City’s water transmission bridge crossing at the WestRock property and subsequent slope evaluation by Northwest Geotech, Inc. the City has identified the need for further evaluation of slope stability on the north bank of the Willamette River from the transmission main bridge crossing at the WestRock Property east to the WTP. This WTP and Bridge Transmission Main Slope Stability Study is recommended in the next year.

A water system Seismic Resilience Study for the City is recommended in the next one to five years. The study is intended to analyze specific seismic hazards in the area based on local geology and topography, identify critical water system facilities and their vulnerabilities to these hazards, and map out a plan to strengthen existing facilities to withstand seismic hazards and/or develop redundant water facilities. The City’s seismic resilience study should be guided by the seismic response and recovery goals for water utilities presented in the Oregon Resilience Plan.

To comply with Oregon Water Resources Department (OWRD) requirements for water permit holders Newberg is required to complete an update of their Water Management and Conservation Plan (WMCP) every 10 years.

It is recommended that the City update this Water Master Plan (WMP) within the next 10 to 20 years. An update may be needed sooner if there are significant changes to the City’s water service area, supply or distribution system which are not currently anticipated.

Future water system planning projects are considered water system performance improvements which benefit all customers. Their estimated costs are allocated 44 percent to future growth based on the ratio of current to projected future system-wide MDD beyond 20 years including the City’s UGB and North Hills URA.

Other

Non-potable Distribution System

As briefly discussed in **Section 1**, Newberg maintains a non-potable “purple pipe” distribution system for irrigation. The system can be supplied from either the City’s Otis Springs source or reuse water from the Newberg Wastewater Treatment Plant (WWTP) effluent. Both non-potable sources are delivered to the Chehalem Glenn Golf Course pond and irrigation system. The publicly-owned golf course is the only existing customer of the City’s reuse system. Reuse pipes have been installed in parallel with other infrastructure and road projects at various locations within the Newberg water service area. However, the majority these non-potable mains are isolated pending future opportunities to connect and expand the reuse system.

As documented in **Appendix B**, expansion of the existing reuse system was evaluated considering both potential new customers with high irrigation use and most efficient interconnection of existing non-potable mains. It was determined that installation of new non-potable water piping from the Otis Springs supply line to serve existing and new development on the north end of the City would be a feasible extension of the existing non-potable system.

Construction of the proposed north non-potable water line could be completed in segments, the first of which would allow Otis Springs supply to serve the proposed Springbrook development. Once piping is complete through the Springbrook development, it may be connected to non-potable mains previously installed by the City in the immediate area. Installation for the first segment of approximately 4,500 linear feet (LF) of 8-inch diameter PVC piping is anticipated within the next 10 years.

Non-potable pumping improvements at Otis Springs are recommended to replace and upgrade aging infrastructure and allow for a constant pressure pumping configuration to serve the expanded non-potable service area.

Public Works Maintenance Facility Improvements

Prior to this Master Plan, the City had identified improvements to Public Works maintenance facilities needed to perform necessary operations and maintenance functions for Newberg's streets, wastewater, storm and water utilities. Costs and timelines for these phased improvements are described in the *Public Works Maintenance Facility Master Plan*. Work on these improvements is anticipated to begin next year and be completed by 2022.

Planned maintenance facility improvements are considered water system performance improvements which benefit all customers. Their estimated costs are allocated 44 percent to future growth based on the ratio of current to projected future system-wide maximum day demands beyond 20 years including the City's UGB and North Hills URA.

CIP Funding

The City may fund the water system CIP from a variety of sources including; governmental grant and loan programs, publicly issued debt and cash resources and revenue. The City's cash resources and revenue available for water system capital projects include water rate funding, cash reserves, and SDCs.

Water Rates

Currently, the City's Rate Review Committee evaluates water rates every two years based on the proposed 5-year CIP. An evaluation of water rates in support of the water system CIP will be completed as follow-on work to this WMP in concert with the next Rate Review Committee evaluation.

System Development Charges (SDCs)

An evaluation of SDCs in support of the proposed water system CIP was conducted as part of this WMP. A description of SDCs, their role in funding capital projects and a summary of the SDC evaluation is presented in the following paragraphs. The full text of the revised SDC Methodology is presented in **Appendix D**.

What is an SDC?

SDCs are sources of funding generated through development and system growth and are typically used by utilities to support capital funding needs. The charge is intended to recover a fair share of the costs of existing and planned facilities that provide capacity to serve new growth.

Oregon Revised Statutes (ORS) 223.297 – 223.314 defines SDCs for the State of Oregon and provides guidelines on the calculation and modification of SDCs, accounting requirements to track SDC revenues, and the adoption of administrative review procedures.

SDCs can be structured to include one or both of the following two components:

1. *Reimbursement Fee* – Intended to recover an equitable share of the cost of facilities already constructed or under construction.
2. *Improvement Fee* – Intended to recover a fair share of future, planned, capital improvements needed to increase the capacity of the system.

The reimbursement fee methodology must consider such things as the cost of existing facilities and the value of unused capacity in those facilities. The calculation must also ensure that future system users contribute no more than their fair share of existing facilities costs. Reimbursement fee proceeds may be spent on any capital improvements or debt service repayment related to the system for which the SDC is applied. For example, water reimbursement SDCs must be spent on water improvements or water debt service.

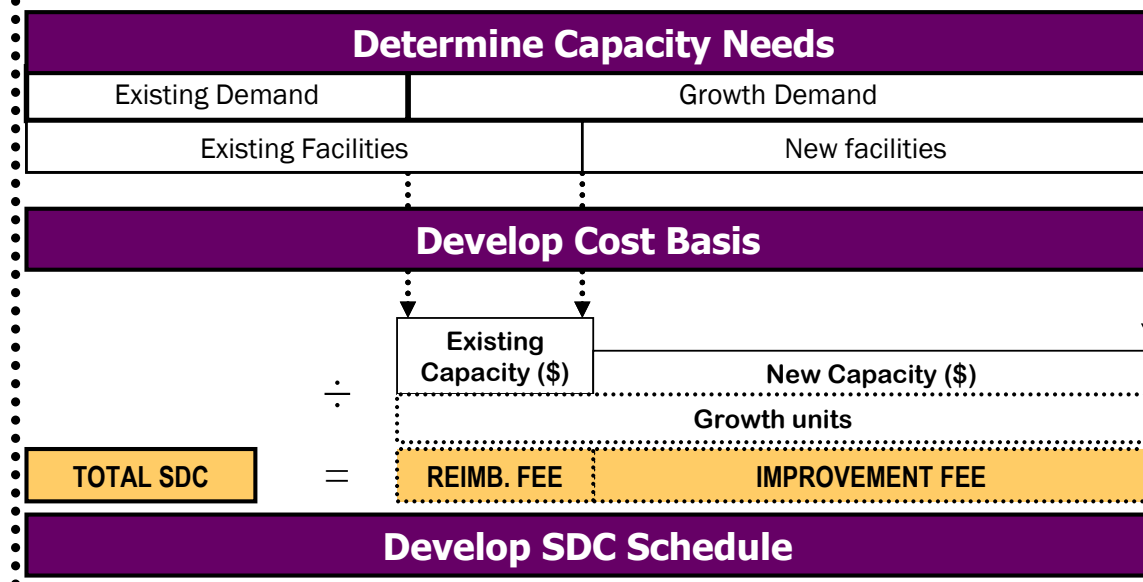
The improvement fee methodology must include only the projected cost of capital improvements needed to increase system capacity as identified in an adopted plan or list, like the water system CIP in this WMP. In other words, the cost of planned projects that correct existing deficiencies, or do not otherwise increase capacity, may not be included in the improvement fee calculation. Improvement fee proceeds may be spent only on capital improvements or related debt service that increase the capacity of the system for which they were applied.

The methodology for establishing or modifying improvement or reimbursement fees shall be available for public inspection 60 days prior to a public hearing.

Revised SDC Methodology Overview

The general methodology used to calculate water SDCs in Newberg is illustrated in **Figure 7-2**. It begins with an analysis of system planning and design criteria to determine growth’s capacity needs, and how they will be met through existing system available capacity and capacity expansion. Then, the capacity to serve growth is valued to determine the “cost basis” for the SDCs, which is then spread over the total growth capacity units to determine the system wide unit costs of capacity. The final step is to determine the SDC schedule, which identifies how different developments will be charged, based on their estimated capacity requirements.

Figure 7-2 Overview of SDC Methodology



Growth Capacity Needs

Capacity requirements are generally evaluated based on the following system design criteria:

- **Maximum Day Demand (MDD)** – The highest daily recorded rate of water production in a year. Used for allocating source, pumping and delivery facilities.
- **Storage Requirements** – Storage facilities provide three functions: operational storage, emergency storage and fire protection storage. Used for allocating storage facility costs.

System MDD is currently about 4.9 mgd, including both potable and non-potable use. Growth in MDD is projected to be about 3.9 mgd over the study period. For supply and delivery purposes, the potable and non-potable systems are evaluated on a combined basis, as collectively the systems will be used to meet future MDD.

Storage requirements are about 5.6 MG currently, and are limited to the potable system. Future storage requirements are expected to be 8.8 MG in Zone 1, and 1.7 MG in Zone 2. Pumping and storage requirements are evaluated separately for each zone.

Develop Cost Basis

The capacity needed to serve new development will be met through a combination of existing available system capacity (reimbursement fee) and additional capacity from planned system improvements (improvement fee). The value of capacity needed to serve growth in aggregate within the planning period is referred to as the “cost basis”.

Reimbursement Fee

The City’s historical investment in water system facilities totals about \$39 million (excluding vehicles and minor equipment costs). The growth share for each asset type is based on capacity needs described in the SDC methodology report in **Appendix D**. The reimbursement fee cost basis excludes any assets (like the sodium hypochlorite equipment) that will be replaced by planned capital improvements. The reimbursement fee cost basis totals \$16.3 million.

Improvement Fee

As with the existing facility costs, the costs of most planned improvements are allocated in proportion to future demands. The total improvement fee cost basis is about \$15 million.

Develop Unit Costs

The system-wide unit costs of capacity are determined by dividing the respective cost bases by the system-wide growth-related capacity requirements. The system-wide unit costs are then multiplied by the capacity requirements per equivalent dwelling unit (EDU) to yield the fees per EDU. In this case an EDU represents the base size meter (3/4-inch) in the City’s water system with an estimated capacity requirement of 605 gallons per day/EDU. This is the standard meter size for a single-family residential service.

Revised SDC

Based on the methodology described above, separate SDCs were established for potable and non-potable customers. The potable SDCs include the full unit cost per EDU, while the non-potable SDCs exclude the costs of storage, upper elevation pumping and other improvements which do not benefit potable system customers.

The total SDC per EDU (3/4-inch meter) for potable and non-potable are \$4,896 and \$3,216, respectively. The SDCs for larger meter sizes are scaled up based on the hydraulic capacity factors as summarized in **Table 5 in Appendix D**.

Summary

See Note 1 & Note 2

This section presented recommendations for improvement and expansion projects in the City's water distribution system. As presented in **Table 7-5**, the total estimated cost of these projects is approximately \$21.9 million through the 20-year planning horizon.

Approximately \$16.9 million of the total estimated cost is for projects needed within the 10-year timeframe and \$11.2 million of these improvements are required in the next 5 years.

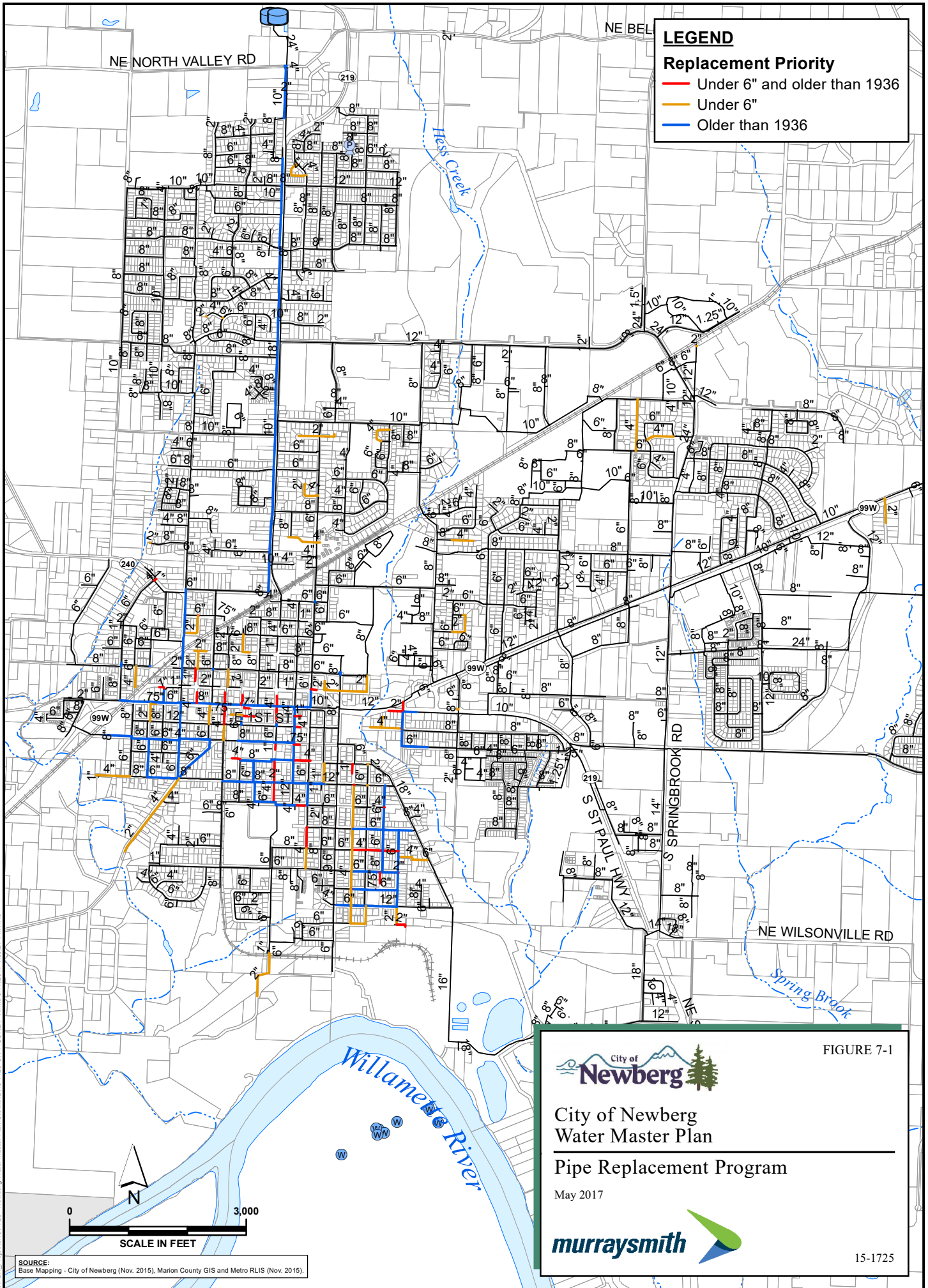
Note 1: See Appendix E, Addendum Riverfront Master Plan (Adopted 5/3/21)

Table 7-5
Proposed Capital Improvement Program (CIP) Summary *See Note 1 & Note 2*

Improvement Category	CIP No.	Project Description	CIP Schedule and Project Cost Summary					Preliminary Cost % to Growth
			5-year	10-year	20-year	Beyond 20 years	Estimated Project Cost	
			2017-2022	2022-2027	2027-2037			
Supply		2 mgd redundant supply development (source, treatment and transmission)	\$ 2,537,150	\$ 1,081,850			\$ 3,619,000	44%
		Hypochlorite generator	\$ 500,000				\$ 500,000	44%
		<i>Subtotal</i>	\$ 3,037,150	\$ 1,081,850	\$ -	\$ -	\$ 4,119,000	\$ 1,812,360
Pump Stations	P-1	Bell East Pump Station - Zone 3 constant pressure	\$ 725,000	\$ 725,000			\$ 1,450,000	97%
	P-2	Bell West Pump Station - Zone 2 constant pressure	\$ 1,450,000				\$ 1,450,000	97%
		<i>Subtotal</i>	\$ 2,175,000	\$ 725,000	\$ -	\$ -	\$ 2,900,000	\$ 2,813,000
Distribution Mains	M-1 thru M-8, M-18	Upsize existing mains and construct new distribution loops to improve fire flow capacity	\$ 2,202,000				\$ 2,202,000	34%
	M-9	NE Zimri Drive Zone 3 distribution backbone within UGB		\$ 346,000			\$ 346,000	97%
	M-14 and M-15	N College Street - N Terrace Street - proposed Bell West P.S. (P-2) - Veritas School	\$ 433,000				\$ 433,000	97%
	M-19	Chehalem Drive water system extension north to Columbia Drive	\$ 600,000				\$ 600,000	100%
		Routine Main Replacement Program ¹	\$ 1,702,000	\$ 1,500,000	\$ 3,000,000	\$ 133,798,000	\$ 140,000,000	0%
		<i>Subtotal</i>	\$ 4,937,000	\$ 1,846,000	\$ 3,000,000	\$ 133,798,000	\$ 143,581,000	\$ 2,104,310
Future High Elevation Water Infrastructure	R-1	1.7 MG Bell Road Reservoir - Zone 3			\$ 339,000	\$ 2,061,000	\$ 2,400,000	88%
	M-16	Zimri Drive East transmission main to Bell Road Reservoir			\$ 815,000	\$ 1,032,000	\$ 1,847,000	97%
	M-17	Bell Road west transmission main - N College Street to Zimri Drive			\$ 761,000	\$ 965,000	\$ 1,726,000	97%
		<i>Subtotal</i>	\$ -	\$ -	\$ 1,915,000	\$ 4,058,000	\$ 5,973,000	\$ 5,577,810
Planning		WTP and Bridge Transmission Main Slope Stability Study	\$ 150,000				\$ 150,000	44%
		Seismic Resilience Study	\$ 150,000				\$ 150,000	44%
		Water Management & Conservation Plan update	\$ 50,000		\$ 50,000		\$ 100,000	44%
		Water Master Plan update		\$ 250,000			\$ 250,000	44%
		<i>Subtotal</i>	\$ 350,000	\$ 250,000	\$ 50,000	\$ -	\$ 650,000	\$ 286,000
Other		North non-potable water line and Otis Springs pumping improvements		\$ 1,750,000			\$ 1,750,000	100%
		Public Works Maintenance Facility Master Plan	\$ 737,500				\$ 737,500	44%
		<i>Subtotal</i>	\$ 737,500	\$ 1,750,000	\$ -	\$ -	\$ 2,487,500	\$ 2,074,500
Capital Improvement Program (CIP) Total			\$ 11,236,650	\$ 5,652,850	\$ 4,965,000	\$ 137,856,000	\$ 159,710,500	\$ 14,667,980
			Annual Average CIP Cost					
			\$2,247,330	\$1,688,950	\$1,092,725			
			5-year	10-year	20-year			

1. Proposed CIP budget for Routine Main Replacement Program in the 20-year planning horizon are less than the identified cost of all recommended main replacements over that timeframe. This deficit is expected to be addressed in future CIP planning beyond the 20-year planning horizon.

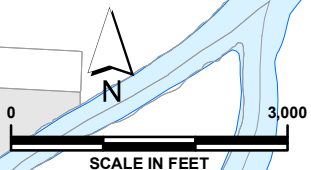
Note 1: See Appendix E, Addendum Riverfront Master Plan (Adopted 5/3/21), Appendix F (Adopted 4/3/23)



LEGEND

Replacement Priority

- Under 6" and older than 1936
- Under 6"
- Older than 1936



SOURCE:
Base Mapping - City of Newberg (Nov. 2015), Marion County GIS and Metro RLIS (Nov. 2015).

FIGURE 7-1

City of Newberg
 Water Master Plan
 Pipe Replacement Program
 May 2017

15-1725

G:\PDX_Projects\151725 - Newberg Water Master Plan\GIS\MXD\15-1725-OR-FIGURE 7-1.mxd 5/17/2017 1:00:27 PM HAS



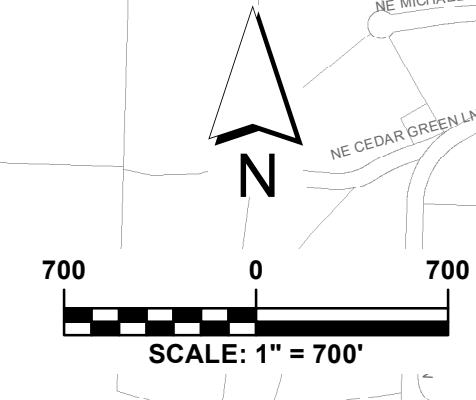
APPENDIX A

City of Newberg
 Water Master Plan
 Proposed Water System Map

May 2017



15-1725

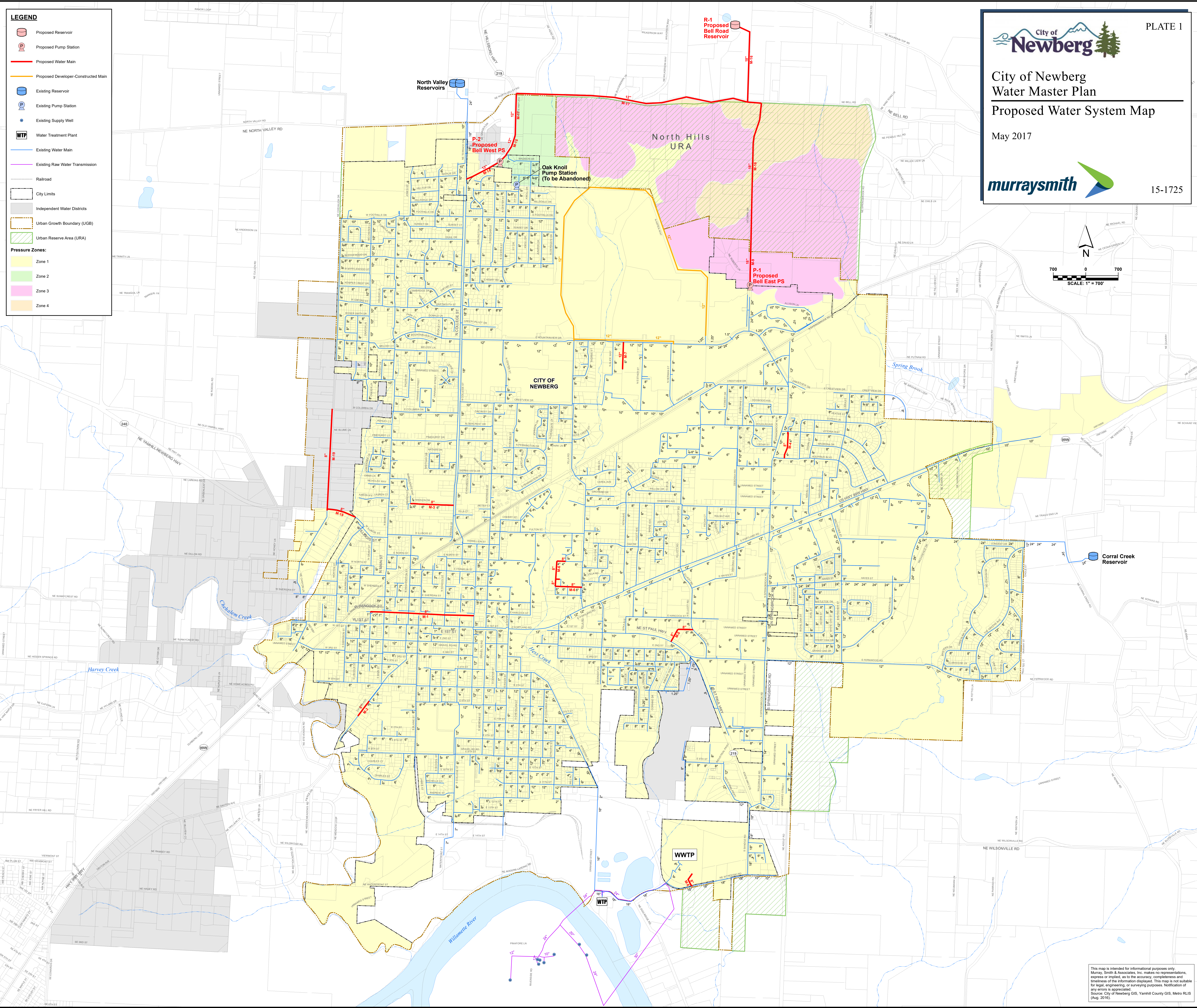


LEGEND

- Proposed Reservoir
- Proposed Pump Station
- Proposed Water Main
- Proposed Developer-Constructed Main
- Existing Reservoir
- Existing Pump Station
- Existing Supply Well
- Water Treatment Plant
- Existing Water Main
- Existing Raw Water Transmission
- Railroad
- City Limits
- Independent Water Districts
- Urban Growth Boundary (UGB)
- Urban Reserve Area (URA)

Pressure Zones:

- Zone 1
- Zone 2
- Zone 3
- Zone 4



This map is intended for informational purposes only. Murray, Smith & Associates, Inc. makes no representations, express or implied, as to the accuracy, completeness and timeliness of the information displayed. This map is not suitable for legal, engineering, or surveying purposes. Notification of any errors is appreciated. Source: City of Newberg GIS, Yamhill County GIS, Metro RLIS (Aug. 2016).



APPENDIX B
RECYCLED WATER USE EVALUATION
FOR
CITY OF NEWBERG

MAY 2017



Murraysmith
888 SW 5th Ave, Suite 1170
Portland, OR 97204
503.225.9010

SECTION B1 INTRODUCTION AND RECYLCED WATER SYSTEM

Purpose

The City of Newberg (City) has requested Murraysmith prepare this report to document the City's existing recycled water (reuse) treatment and distribution facilities, as well as to review and summarize current regulations dictating allowable uses for non-potable water generated from its wastewater treatment plant (WWTP). This report documents an evaluation of possible expansion of the existing recycled water facilities, including a conceptual level plan of the piping network required to supply recycled water to potential future customers. Conceptual level project cost estimates for development of the build-out recycled water system are also included for planning purposes.






Background

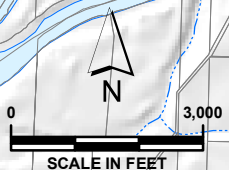
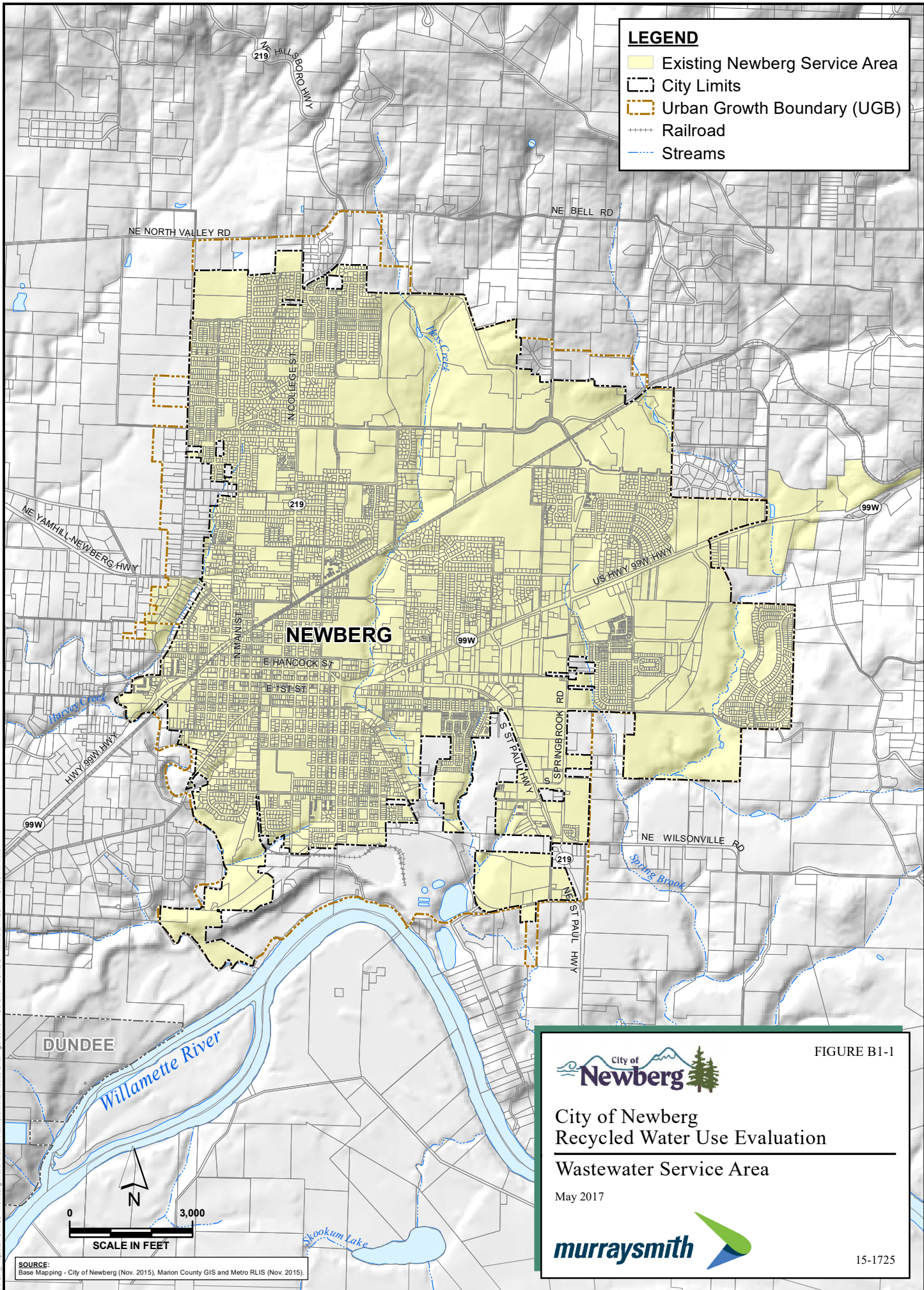
The City owns and operates a secondary wastewater treatment plant (WWTP) located at 2301 Wynooski Road in Newberg, Oregon. The WWTP has been in service since 1987. The facility provides wastewater collection and treatment services for residential, commercial, and industrial customers located with the city limits. A small number of residences located outside of the city limits are also served by the WWTP. A map of the City's service area limits is presented in **Figure B1-1**.

The WWTP is a Class IV oxidation-ditch type facility. The secondary treatment facility produces Class A compost product from its biological activated sludge plant, which the City sells under the name NEWGROW to the public throughout the year. Treated water discharged from the WWTP is either directed to the Willamette River or routed for additional treatment onsite to produce tertiary treated, recycled water. The tertiary membrane filtration reuse facility at the WWTP produces Class A effluent waters suitable for irrigating golf courses, school yards, and residential landscaping with minimal regulatory restrictions. Beneficial reuse of effluent is seasonal, because irrigation demands typically run from May through the first half of September.

Currently, the Chehalem Glenn Golf Course, located approximately one and a half miles northeast of the WWTP, is the sole recipient of the City's recycled water. Treated effluent is pumped from the WWTP through a dedicated 10-inch diameter recycled water main directly to a meter and associated private line to storage facilities on the golf course. Dedicated mains for recycled water are constructed of purple polyvinyl chloride (PVC) piping, termed in the industry as purple pipe; these purple pipes are not cross-connected with existing potable water mains. The City has been constructing limited segments of new purple pipe in association with all new underground utility installation projects.

LEGEND

-  Existing Newberg Service Area
-  City Limits
-  Urban Growth Boundary (UGB)
-  Railroad
-  Streams



SOURCE:
Base Mapping - City of Newberg (Nov. 2015), Marion County GIS and Metro RLIS (Nov. 2015).



FIGURE B1-1

City of Newberg
Recycled Water Use Evaluation

Wastewater Service Area

May 2017



© IPDX, Project#151725 - Newberg Water Master Plan/GIS/MXD/Reuse Eval Figures/15-1725-OR-FIGURE B1-1.mxd, 5/17/2017, 1:07:03 PM HAS

Wastewater Treatment Facilities

The City's secondary treatment facilities at the WWTP consist of a raw influent pump station, headworks, activated sludge oxidation ditches, secondary clarifiers, chlorine disinfection, dechlorination, effluent outfall, and biosolids composting. Disinfection of the effluent is performed with chlorine gas. Treated and disinfected effluent is dechlorinated with sodium bisulfite prior to flow measurement and discharge. Treatment plant effluent is discharged to the Willamette River or routed to an onsite tertiary membrane filtration facility for beneficial reuse.

The City constructed a tertiary membrane filtration reuse facility, called the Reuse Building, at the WWTP in 2008. The facility is designed to produce Class A recycled water meeting the standards defined in Oregon Administrative Rule (OAR) 340-55. The current capacity for the facility is 1 million gallons per day (mgd).

Existing Tertiary Water Treatment Facilities

The existing recycled water treatment system is comprised of a retrofitted chlorine contact basin at the end of the WWTP's secondary treatment chain; membrane raw water supply pumps; membrane filtration package system skids; membrane filter backwash systems; a single recycled water storage tank; and recycled water effluent pumps. The entire recycled water treatment system has been integrated into the City's Supervisory Control and Data Acquisition (SCADA) system to allow for optimizing controls. Individual components of the recycled water treatment system are discussed in further detail as follows. A schematic overview of the recycled water system is provided in **Figure B1-2**.

Chlorine Contact Basin

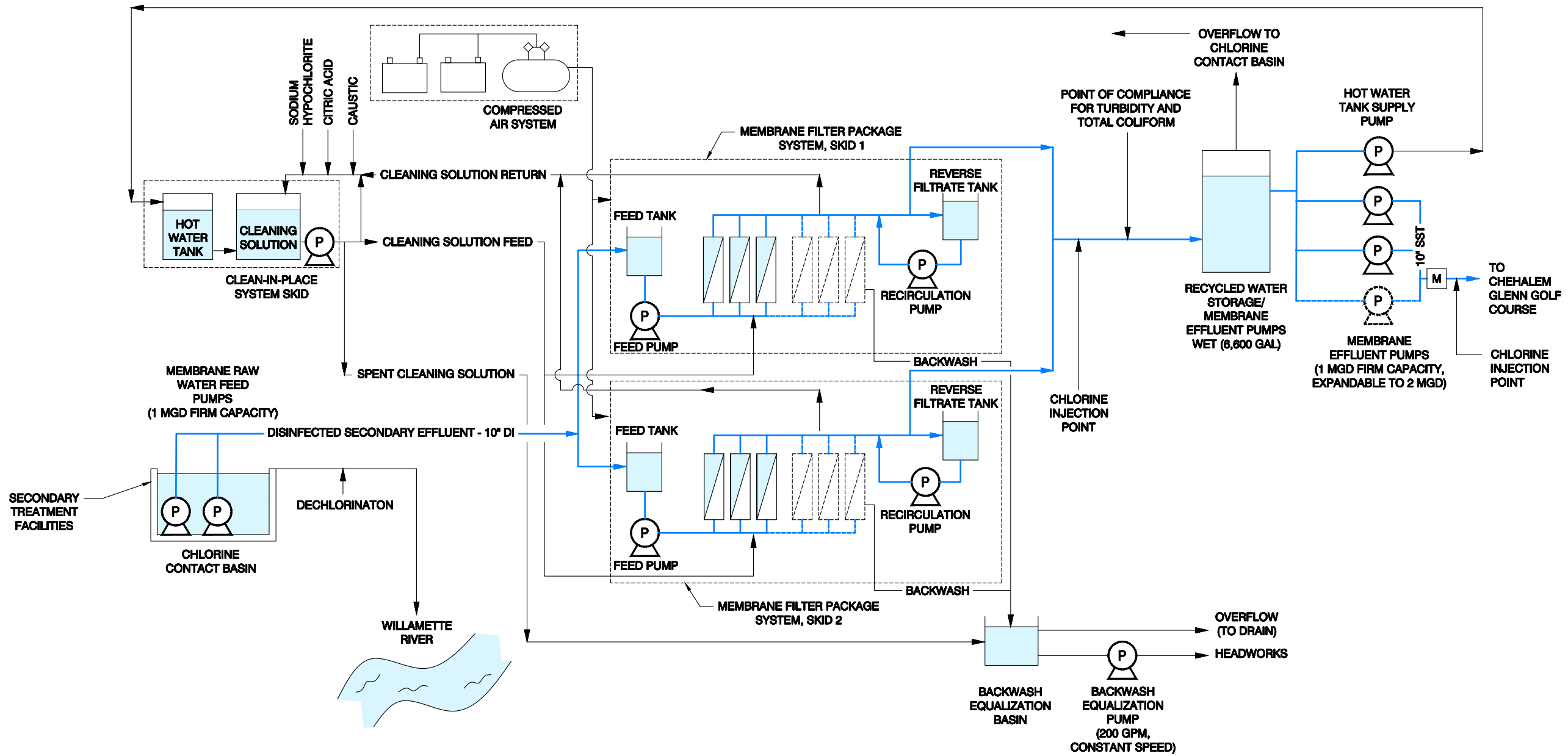
Following secondary clarification at the WWTP, plant flows are directed to a chlorine contact basin (CCB). Flows travel the length of the CCB at a rate designed to allow for sufficient chlorine contact time prior to discharging effluent to the downstream system. An overflow weir at the far end of the CCB directs flows through a dechlorination metering system prior to effluent discharge to the Willamette River. Membrane raw water feed pumps located within an existing pump wet well at the far end of the CCB provide supply to the WWTP's tertiary treatment facilities.

An operator-selected LOW setpoint at the CCB outfall weir and a HIGH setpoint below the top of CCB wall maintain desired water elevations within the CCB. An additional hard-coded LOW-LOW level setpoint has been provided to maintain an acceptable water surface level above the membrane raw water feed pumps to minimize the potential for pump damage.

Membrane Raw Water Supply Pumps

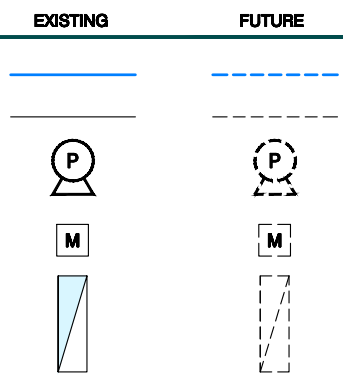
Two constant speed vertical turbine pumps installed within the CCB act as the membrane raw water feed pumps. The pumps provide a firm capacity of approximately 700 gallons per

C:\P\Projects\151725 - Newberg Water Master Plan\1.1 Non-Potable Water Re-Use Evaluation\Figures\2016-06-15\15-1725-41-08-F108E B1-2.dwg PROCESS Flow DIAGRAM 5/16/2017 7:24 PM DWG 2.0a (LMS Tech)



LEGEND

- MAIN PROCESS FLOW
- SUPPORTING PROCESS FLOW
- PUMP
- ELECTROMAGNETIC FLOW METER
- MEMBRANE FILTER



ABBREVIATIONS

- | | |
|-----|-------------------------|
| DI | DUCTILE IRON |
| GAL | GALLONS |
| GPM | GALLONS PER MINUTE |
| MGD | MILLION GALLONS PER DAY |
| SST | STAINLESS STEEL |

FIGURE B1-2

CITY OF NEWBERG

TERTIARY TREATMENT
PROCESS FLOW DIAGRAM
May 2017

15-1725

minute (gpm) (1 mgd). The pumps discharge flows to two membrane filtration package system skids, located in the neighboring Reuse Building, via a 10-inch diameter ductile iron (DI) header pipe for further treatment.

Raw water pumping rates are determined by reuse water production rates input into the SCADA system by the operator. The pumps will stop once SCADA no longer receives the raw water production request or the hard-coded LOW-LOW alarm in the CCB is reached. If the pumps are stopped from a programmed shutoff, they will remain off until the water level within the CCB rises to a hard-coded setpoint above the pumps.

Membrane Filtration Package System Skids

Chlorinated secondary effluent pumped from the CCB to the Reuse Building is delivered to two membrane filtration package system skids installed in parallel off of the 10-inch diameter DI header supply line. The two expandable membrane filter trains share a single control panel to manage all filtration and cleaning processes. The system is currently programmed to produce 200 to 800 gpm (0.3 to 1.15 mgd) of recycled water.

The first component for each of the package systems is an open-air membrane filter feed tank. From this tank, a feed pump provides pressurized flow to the membrane filtration systems. Each membrane module contains thousands of hollow tubes, which are the filtration membranes. Once passed through the filtration membranes, the treated water is delivered to an open-air reverse filtrate tank at the end of each package skid or to the recycled water storage tank. The filtrate tank supplies a recirculation pump, which provides pressurized water for backwashing the filtration membranes, as needed.

Each membrane module is backwashed at regular intervals throughout the day to dislodge and remove residual material left on the outside of the membrane. Compressed air is run from the inside of the filtration membrane installation during backwash to aid in the cleaning. Similar, though more intense, cleaning cycles are performed several times a day, and an even stronger clean-in-place (CIP) chemical cleaning of the membranes is conducted on a monthly basis. The CIP process is supplemented by hot water (90 to 100 degrees F) provided via a system consisting of a hot water storage tank with an internal electrical heating system provided by the membrane filter supplier. Backwash and cleaning cycles for filtration membranes are initiated by pressure loss across the membranes and controlled by the membrane filter system package control panels. Filter backwash flows are directed to a backwash equalization basin, where flows are pumped back to the WWTP headworks via a 200 gpm constant speed submersible pump.

Recycled Water Storage Tank

Tertiary treated effluent from both membrane filtration package treatment skids is combined into a single pipe for delivery to the recycled water storage tank. This combined effluent pipe is the regulatory point of compliance for recycled water quality produced by the facility. The effluent pipe is equipped with a turbidity meter and a grab sample valve for monitoring total coliforms. In the event of high turbidity in the recycled water, the downstream

membrane effluent pumps will shut down. Chlorine solution may be injected into this line to provide a chlorine residual in the effluent water, as well as to control water quality within the recycled water storage tank.

The recycled water storage tank is approximately 6,600 gallons in volume. The tank is located outside and adjacent to the Reuse Building. The tank functions as the wet well for the membrane effluent pumps.

Water failing to meet regulatory standards and overflows from the recycled water tank are routed back to the inlet structure of the CCB. Water level in the tank is monitored by a pressure differential transmitter and relayed by SCADA, which will alarm at operator-selected HIGH and LOW setpoints. Float level switches provide redundant monitoring of water level in the tank.

Membrane Effluent Pumps

Two dry pit centrifugal horizontal end suction pumps are installed adjacent to the recycled water storage tank for distributing membrane filter effluent. The pumps provide a firm capacity of up to approximately 700 gpm (1 mgd). The pumps are adjustable speed and can be set by operators to maintain a constant level in the recycled water storage tank. The pumps discharge to a 10-inch diameter stainless steel header before combining in a single 10-inch diameter recycled water pipeline to provide irrigation water to Chehalem Glenn Golf Course.

If the pumps fail or are turned off, flows will back up into the recycled water storage tank. Tank overflows are routed back to the inlet structure for the CCB. Flows from the membrane filter effluent pumps are measured by an electromagnetic flow meter as prior to leaving the WWTP site. Chlorine solution may be added to the membrane filter effluent pump discharge/recycled water pipeline to provide a chlorine residual in the recycled water supplied to the Chehalem Glenn Golf Course.

Standby Power Generator

The Reuse Building is connected to an onsite 2 megawatt (MW) standby power generator, allowing the facility to remain completely functional in the event of power outage. The generator has been provided to meet with DEQ requirements for emergency power generation for recycled water treatment facilities. In the event the power generation facilities should fail, the recycled facility will not be operational. Recycled water will not be provided to customers, nor will it leave the facility unwanted, as the tertiary treated effluent must be discharged through the membrane effluent pumps to reach its customers.

Improvements for Expansion

The WWTP's tertiary treatment facilities were designed to allow for future expandability, upgrading capacity from the current 1 mgd to a future 2 mgd. For the City to reach this future

maximum capacity for providing reused water, the various improvements to the existing facilities which follow will be necessary.

Membrane Raw Water Supply Pumps

The two existing 1 mgd membrane raw water supply pumps will need to be removed and replaced with two new pumps sized with an individual capacity of 2 mgd. It is understood the existing pumping pit within the CCB is not of sufficient size to allow for a third pump installation to boost the current capacity. Replacement of the existing pumps will provide the City with 2 mgd of firm raw water pumping capacity.

Membrane Filtration Package System Skids

The existing membrane filtration package system skids have expandable membrane filter trains. As the two package systems combine to currently produce a maximum of 800 gpm (1.15 mgd) of recycled water, the amount of membrane filtration will need to nearly double. As the system build-out capacity of 2 mgd was noted in design of the system skids, there should be adequate capacity in the skids to accommodate this capacity upgrade.

Membrane Effluent Pumps

An additional pump with a capacity of approximately 700 gpm (1 mgd) will need to be installed adjacent to the two existing membrane effluent pumps to provide a firm recycled water pumping capacity of 2 mgd. Accommodations will need to be made at the existing 10-inch diameter stainless steel discharge header to allow for the third pump.

The existing 10-inch diameter reuse water pipeline which provides irrigation water to Chehalem Glenn Golf Course has been previously sized to accommodate the future 2 mgd membrane effluent pumps discharge. Maximum flows may be anticipated to be approximately 6 feet per second in this line.

Summary

This section provided documentation of the City's existing wastewater treatment facilities, including a schematic overview and detailed discussion on the various components of the recycled water system. Existing tertiary treatment facilities are expandable from 1 mgd to 2 mgd should future demands require.

SECTION B2

REGULATORY JURISDICTION

The design, construction, and operation of the City of Newberg's (City's) wastewater treatment plant (WWTP) and effluent reuse system fall under the jurisdiction of the State of Oregon's Department of Environmental Quality (DEQ). The DEQ regulates the City's WWTP under an existing National Pollution Discharge Elimination System (NPDES) waste discharge permit issued in 2004. The permit was modified in 2008 to include reuse of treated effluent for golf course irrigation at the Chehalem Glenn Golf Course and impose thermal loading limits for discharge to the Willamette River. The City's existing NPDES permit expired May 31, 2009 and is currently on administrative extension, as no additional modifications to the prior permit have been requested by the City.

The WWTP's tertiary treatment facility is designed to produce Class A recycled water meeting the standards defined in Oregon Administrative Rule (OAR) 340-55 and summarized as follows.

Treatment

Class A recycled water must be oxidized, filtered, and disinfected prior to distribution. The recycled water must meet the quantitative criteria following treatment as follows.

Turbidity

Prior to disinfection, the wastewater must be treated with a filtration process. Turbidity of the water must not exceed an average of 2.0 nephelometric turbidity units (NTU) within a 24-hour period, 5 NTU for more than five percent of the time within a 24-hour period, and 10 NTU at any time.

Monitoring for turbidity must occur, at a minimum, on an hourly basis during recycled water production.

Total Coliforms

Following disinfection, Class A recycled water must not exceed a median of 2.2 total coliform organisms per 100 milliliters (mL), based upon results of the previous seven days in which analysis has been completed. No single sample shall have more than 23 total coliform organisms per 100 mL.

Monitoring for total coliform organisms must occur, at a minimum, on a once per day basis during recycled water production.

Additional Monitoring Requirements

The DEQ has requested the City monitor the following water quality parameters daily during the production of recycled water:

- Flow volume
- Chlorine residual
- pH
- Nutrient content

Beneficial Purposes

It is the policy of the DEQ to encourage the use of recycled water for domestic, agricultural, industrial, recreational, and other beneficial purposes in a manner which protects public health and the environment of the state. The term beneficial purpose is defined by the DEQ as a purpose where recycled water is utilized for a resource value, such as nutrient content or moisture, to increase productivity or to conserve other sources of water.

Class A recycled water is the highest quality of recycled water which may be produced, acceptable for use in all beneficial purposes which lower quality Class B, C, and D recycled water are allowable. Class A recycled water may be used for the following beneficial purposes where all other rules of OAR 340-55 are met:

- Irrigation of any agricultural or horticultural use, including the following:
 - Processed food crops
 - Orchards or vineyards, if an irrigation method is used to apply recycled water directly to the soil
 - Firewood, ornamental nursery stock, Christmas trees, sod, or pasture for animals
 - Growing fodder, fiber, seed crops, or commercial timber
- Landscape irrigation of parks, playgrounds, school yards, residential landscapes, golf courses, cemeteries, highway medians, industrial or business campuses, or other landscapes accessible to the public
- Commercial car washing or fountains when the water is not intended for human consumption
- Water supply source for restricted and non-restricted recreational impoundments
- Artificial groundwater recharge by surface infiltration methods or by subsurface injection in accordance with OAR Chapter 340, division 44
- Stand-alone fire suppression systems in commercial and residential buildings, non-residential toilet or urinal flushing, or floor drain trap priming
- Industrial, commercial, or construction uses limited to: industrial cooling, rock crushing, aggregate washing, mixing concrete, dust control, non-structural firefighting using aircraft, street sweeping, or sanitary sewer flushing

It should be noted where sprinkler irrigation is to use Class A recycled water, recycled water must not be sprayed onto an area where food is being prepared or served, or onto a drinking fountain. Additionally, when recycled water is to be used for agricultural, horticultural or landscape purposes where spray irrigation may be used, or for an industrial, commercial, or construction purposes, the public and personnel at the use area must be notified and signage must be posted noting recycled water is being used and that is not safe for drinking.

Operational Requirements

The operations of a recycled water facility must meet certain requirements set forth by the DEQ, which are summarized as follows.

Recycled Water Use Plan

All use of recycled water must conform to a recycled water use plan approved by DEQ. A recycled water use plan details how the wastewater treatment system owner will comply with the requirements of OAR 340-055. Existing treatment systems and methods must be detailed in the plan. Monitoring and sampling procedures must be documented, operational contingency plans are to be detailed, and estimates for recycled water production are to be documented in the plan.

The City is currently operating under the DEQ-approved *Recycled Water Use Plan for the Chehalem Glenn Golf Course* (CH2M Hill, August 2008). Should the City wish to modify existing systems and/or methods for treatment of its recycled water, or should the City want to add new customers or distribution systems to its existing recycled water system, an updated recycled water plan would be required for review and approval by DEQ.

Facility Requirements

Facilities treating and distributing recycled water must have the following systems in place for DEQ approval.

- *Alarm devices.* In the event of power loss or failure of process equipment essential to the proper operation of the treatment system, alarm devices are required to provide warning.
- *Standby power.* A recycled water treatment system must have sufficient standby power to fully operate all essential treatment processes, unless otherwise approved in writing by DEQ.
- *Redundancy.* A sufficient level of redundant systems and monitoring equipment must be in place to prevent inadequately treated water from being used or discharged from the facility.
- *Cross-connection control.* Connection between a potable water supply system and a recycled water distribution system is not authorized, unless the connection is provided through a DEQ-approved air gap separation. Additionally, all piping and appurtenances associated with a recycled water use system which is outside the

treatment building must be constructed and marked in a manner which prevents cross-connection to a potable water system.

Blending Recycled Water

The DEQ may approve on a case-by-case basis blending recycled water with other water for distribution to non-potable water systems. Before blending recycled water, the wastewater treatment system owner must obtain written authorization from DEQ. In obtaining authorization, the wastewater treatment system owner must submit the following information for review and approval:

- An operations plan
- A description of any additional treatment process
- A description of blending volumes detailed by source
- A range of final recycled water quality at the compliance point identified in the NPDES permit

Waters of the State

No discharge of recycled water is allowed to waters of the state. All recycled waters are to be stored and/or distributed for beneficial purposes. Waters of the state are defined by DEQ as lakes, bays, ponds, impounding reservoirs, springs, wells, rivers, streams, creeks, estuaries, marshes, inlets, canals, the Pacific Ocean within the territorial limits of the State of Oregon, and all other bodies of surface or underground waters, natural or artificial, inland or coastal, fresh or salt, public or private (except those private waters which do not combine or effect a junction with natural surface or underground waters) that are located wholly or partially within or bordering the state or within its jurisdiction.

Summary

The WWTP's tertiary treatment facility is designed to produce Class A recycled water, as defined in OAR 340-55. Class A recycled water is the highest quality of treated water which may be produced, acceptable for many beneficial uses. The operational requirements and beneficial purposes for recycled water production have been provided in this section.

SECTION B3

EXISTING AND FUTURE DEMANDS FOR NON-POTABLE WATER

This section presents existing and projected future non-potable water demands for the City of Newberg's (City's) service area. Demand forecasts are developed from review of historic water use records, as well as from discussions with City staff, to determine likely future non-potable water customers. Potential future demands focus on supplying water for irrigation of residential, industrial and commercial customers.

Service Area

Existing

The sole customer for the City's non-potable water is the Chehalem Glenn Golf Course. The course's 18 holes and driving range total approximately 188 acres, with about 120 acres of the facility being irrigated turf. The golf course's irrigation system has been installed such that it may receive water from any combination of three available sources: recycled water from the City's wastewater treatment plant (WWTP), non-potable water from Otis Springs, and City potable water.

Future

The study area for potential future non-potable water uses include all areas within the city limits and the urban growth boundary (UGB). Areas located outside of the UGB were not investigated, as the City has no reasonable timetable for bringing these properties into the service area.

Non-Potable Water Resources

Wastewater Treatment Plant

Current production capacity at the City's WWTP for recycled, or tertiary treated, water is approximately 1 million gallons per day (mgd). The facility was designed and constructed to allow for expansion of capacity up to 2 mgd.

Otis Springs

Otis Springs is located northeast of Newberg's city limits, directly north of Highway 99E at the foot of Rex Hill. The spring was once used as a supply source for the City's potable water system; however, the Department of Environmental Quality (DEQ) determined Otis Springs to be surface water influenced, and it is no longer connected to the City's potable water system. Pumps at Otis Springs are run based on water level of the irrigation water storage ponds at the Chehalem Glenn Golf Course, and production is metered at both the spring and the golf course. The City reports a production capacity for Otis Springs of up to 0.5 mgd, though maximum flows seen in historical records approach only 0.3 mgd.

Historical Non-Potable Water Demand

The only purchaser to date for the City's non-potable water is the Chehalem Glenn Golf Course. The golf course's non-potable water demand is solely for irrigation of turf. The facility's irrigation demand is met by a combination of the WWTP's recycled water and flows from Otis Springs.

Production records from the City's two non-potable water sources were evaluated to determine historical non-potable water system demands. Daily recycled water production figures from the WWTP were available from the City's Supervisory Control and Data Acquisition (SCADA) system. In the absence of daily production records for Otis Springs, daily production rates were calculated for individual months by averaging total monthly supply over the number of days in each month. Records indicate non-potable water irrigation demands typically begin on or around the start of June and continue through the middle of September, making for an average duration of approximately 16 weeks, or 112 days, for the irrigation season. **Figure B3-1** provides a graphical representation of the daily non-potable water demands for the golf course over full irrigation seasons for the years 2013-2015, with total demand also being separated by individual sources.

The graphs in **Figure B3-1** demonstrate the highly variable nature of non-potable water demand over an irrigation season. The data shows a typical seasonal peak day of approximately 0.6 mgd, with most of these flows being provided as WWTP recycled water. Large spikes in demand seen in July may be accounted for in the golf course banking irrigation water at its onsite storage ponds in preparation of ceasing flows from Otis Springs in the following month of August. A minor modification in the golf course's operations would allow them to begin banking non-potable water for irrigation earlier in the season, likely resulting in a more even distribution of peak demands over the season. Average irrigation season demands total approximately 42 million gallons (MG), with an average daily demand of 0.4 mgd.

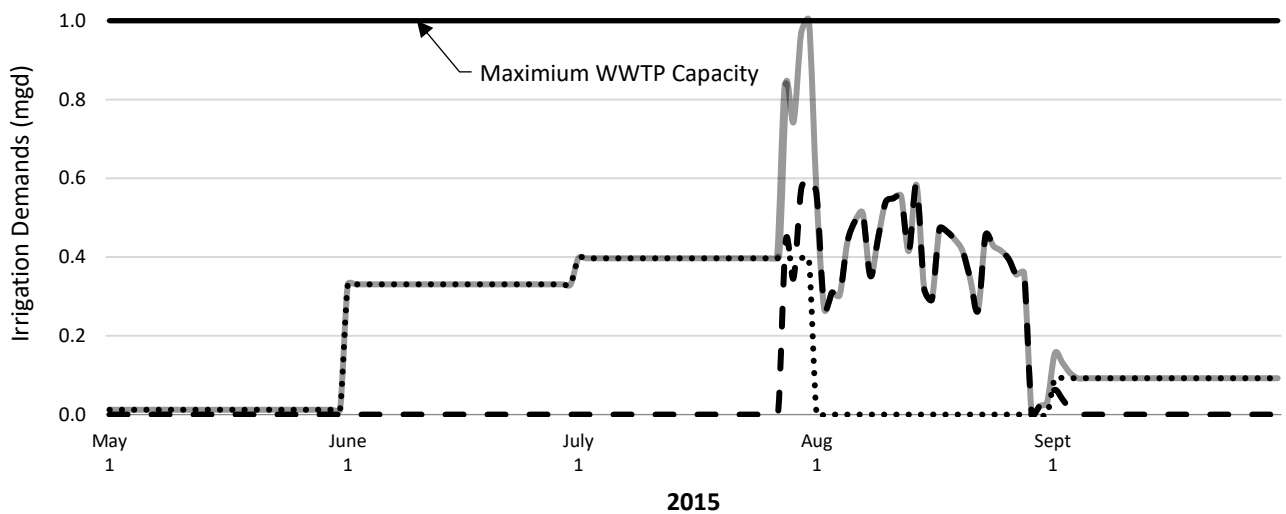
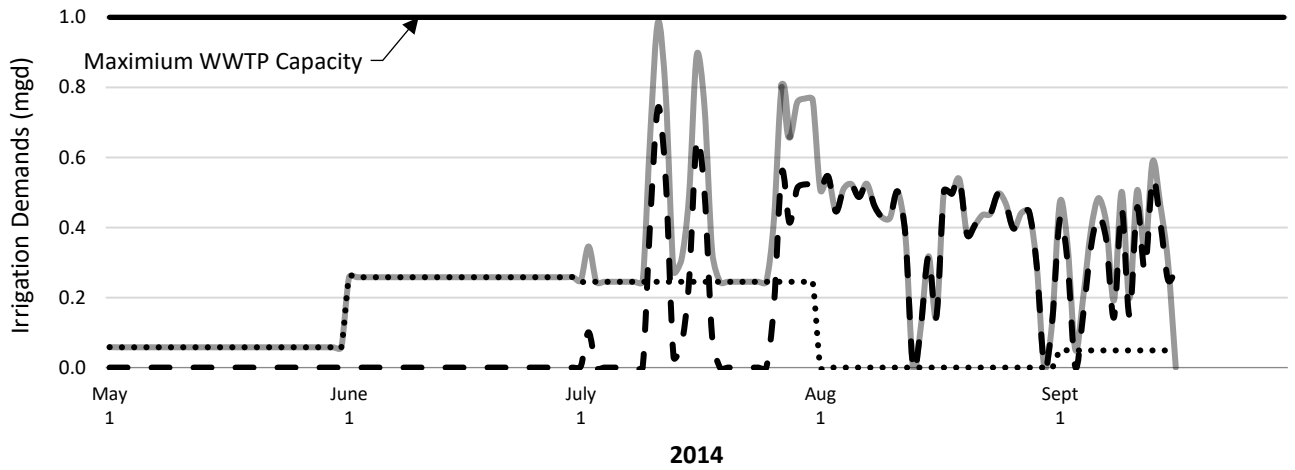
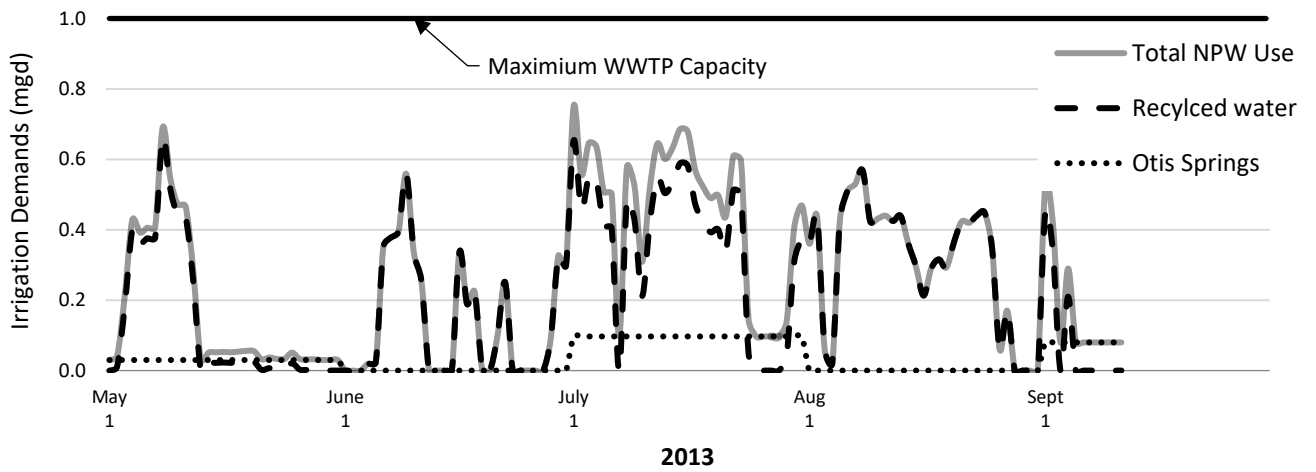


Figure B3-1: Irrigation demands, 2013 - 2015

Future Non-Potable Water Customers and Demand Forecast

Demand forecasts for the City's non-potable water have been developed from a review of historic irrigation water service meter records to determine likely future non-potable water distribution system customers. Those potable water service customers which have existing water meters classified by the City solely for irrigation purposes were examined to determine an overall irrigation demand which may be satisfied using non-potable water. Discussions with City staff were then used to determine the likelihood of an existing irrigation water meter owner to take part in any future expanded non-potable water distribution system. Additionally, a property's vicinity to existing non-potable water distribution infrastructure was used as part of this evaluation.

In reviewing irrigation water service meter records for the individual 2013, 2014, and 2015 seasons, it was determined overall irrigation demands remain consistent on a year-to-year basis. For the purpose of this evaluation and determining potential future irrigation water demands, it has been assumed future irrigation demands for individual properties will remain similar to those currently being recorded. Subsequently, for this evaluation, overall demands for the City's non-potable water will only increase with the addition of new irrigation customers along any new distribution system.

The City has approximately 100 water meters classified for irrigation use. This evaluation looked at those irrigation water services with annual metered use of approximately 450,000 gallons (average daily demand of 3,250 gallons per day) or greater. Irrigators using a minimum of 450,000 gallons annually are within the top 40 percent of the City's irrigation water users, with flows of a high enough volume to warrant interest in any expansion of the City's non-potable water program. In instances where one owner had multiple irrigation water service meters distributed over a single location, individual meter flows were summed into one total demand figure. For instance, George Fox University has 8 irrigation meters across a single large campus, and this customer's use is reported as a single irrigation demand.

Irrigation water demands for the City's top users are summarized in **Table B3-1** for the 2013, 2014, and 2015 seasons. Information on the City's top irrigators provided in **Table B3-1** includes a ranked listing of users from high to low annual consumption, City water meter account number, property owner, physical location of water meter, and total consumption of water in gallons per year. The City's top irrigators, including the Chehalem Glenn Golf Course, account for approximately 89 MG (0.80 mgd) in current irrigation water and potential non-potable water demand. With the addition of the proposed Springbrook Development within the north end of the city limits, which has the potential to become the City's second largest non-potable water consumer, total irrigation season demands increase to nearly 100 MG (0.89 mgd).

**Table B3-1
Irrigation Water Demand Summary**

User Ranking	City Account No.	Owner	Physical Address	2013 Consumption (gallons)	2014 Consumption (gallons)	Consumption (cf) (sum for 2015)	2015 Consumption (gallons)	Average Annual Consumption (gallons)
1	018486-000	CHEHALEM GLENN GOLF COURSE, RECYCLED WATER SOURCE	4501 E FERNWOOD RD	31,463,872	24,093,828	1,944,600	14,545,608	23,367,769
	014711-000	CHEHALEM GLENN GOLF COURSE, OTIS SPRINGS SOURCE	4501 E FERNWOOD RD	5,473,385	18,878,383	4,218,558	31,554,814	18,635,527
2	--	SPRINGBROOK DEVELOPMENT	--	--	--		--	10,860,000
3	Multiple	BPM HOA MANAGEMENT	SPRINGBOOK OAKS	6,654,208	6,534,528	716,400	5,358,672	6,182,469
4	Multiple	GEORGE FOX UNIVERSITY	414 N MERIDIAN ST	5,434,220	4,123,724	526,500	3,938,220	4,498,721
5	Multiple	NEWBERG S.D. / NEWBERG HIGH SCHOOL	2400 DOUGLAS AVE, ATHLETIC FIELD	3,837,988	3,880,624	350,500	2,621,740	3,446,784
6	000265-001	CHEHALEM PARK & REC / DARNELL WRIGHT SOFTBALL COMPLEX.	303 W FOOTHILLS DR	2,487,100	3,547,016	399,400	2,987,512	3,007,209
7	009758-000	FRIENDSVIEW MANOR	1301 E FULTON ST UNIT C	2,597,056	2,871,572	436,600	3,265,768	2,911,465
8	001936-000	HAZELDEN BETTY FORD FOUNDATION	1901 ESTHER ST	2,951,608	1,327,700	329,300	2,463,164	2,247,491
9	019966-000	EMERITUS LIVING	3802 HAYES ST	2,700,280	1,322,464	336,700	2,518,516	2,180,420
10	019222-000	ARBOR OAKS MEMORY CARE	317 WERTH BLVD	1,605,208	2,462,416	172,900	1,293,292	1,786,972
11	010588-000	NEWBERG S.D. / JOAN AUSTIN ELEMENTARY	2200 N CENTER ST	2,561,900	2,062,984	96,000	718,080	1,780,988
12	000090-000	NEWBERG S.D. / CHEHALEM VALLEY MIDDLE SCH	403 W FOOTHILLS DR	3,286,712	946,968	107,900	807,092	1,680,257
13	002096-001	NEWBERG S.D. / MT VIEW MID SCHOOL	2015 EMERY DR	2,143,020	1,673,276	120,500	901,340	1,572,545
14	018955-000	ALLISON INN AND SPA	2525 ALLISON LANE-ZIMRI DR-2" METER	362,032	3,186,480	61,100	457,028	1,335,180
15	001201-003	CHEHALEM PARK & REC / J JAQUITH FIELDS	1215 N COLLEGE ST	880,396	1,403,248	180,800	1,352,384	1,212,009
16	004804-000	FRED MEYER	3300 PORTLAND RD	1,095,820	1,306,008	146,200	1,093,576	1,165,135
17	004974-000	PGE	1101 WILSONVILLE RD	783,156	828,036	230,200	1,721,896	1,111,029
18	014221-000	OAK MEADOWS @ NEWBERG	3897 OAK MEADOWS LP	1,013,540	1,075,624	121,900	911,812	1,000,325
19	023433-001	NO OWNER ON RECORD	NO ADDRESS ON RECORD		759,220	132,800	993,344	584,188
20	Multiple	VITTORIA SQUARE	3300 VITTORIA WAY	607,376	759,968	167,100	1,249,908	872,417
21	004467-000	NEWBERG S.D. / EDWARDS ELEMENTARY	715 E 8TH ST	1,293,292	479,468	101,900	762,212	844,991
22	015302-000	WERTH FAMILY, LLC	TRACT A, WERTH BLVD	638,792	797,368	124,200	929,016	788,392
23	014252-000	OAK MEADOWS @ NEWBERG	DETENTION POND @ OAK MEADOWS	698,632	769,692	82,300	615,604	694,643
24	011226-001	THE GREENS @ FERNWOOD RD, NW CORNER @ WTR FOUNTAIN	GREENS AVE	708,356	667,216	88,600	662,728	679,433
25	004935-000	CANYON RIDGE APT	401 S EVEREST RD	790,636	444,312	101,500	759,220	664,723
26	004948-000	PARR LUMBER	200 N ELLIOTT RD	590,172	583,440	104,200	779,416	651,009
27	010431-002	NO OWNER ON RECORD	NO ADDRESS ON RECORD	297,704	575,212	117,500	878,900	583,939
28	014761-002	NO OWNER ON RECORD	NO ADDRESS ON RECORD	392,700	742,764	76,200	569,976	568,480
29	001745-000	SPRINGBROOK APARTMENTS	1401 SPRINGBROOK RD	579,700	563,992	61,000	456,280	533,324
30	003896-002	CHEHALEM PARK AND REC / REC CENTER	502 E 2ND ST	256,564	430,848	111,700	835,516	507,643
31	015301-001	WERTH FAMILY, LLC	TRACT C, PROVIDENCE DR	488,444	386,716	67,000	501,160	458,773
32	001753-000	A-DEC	2601 CRESTVIEW DR - BLDG	296,208	491,436	75,600	565,488	451,044
Total Annual Consumption(gallons):				84,970,077	89,976,531	11,907,658	89,069,282	98,865,297
Total Annual Consumption(mgd):				0.76	0.80	0.11	0.80	0.88

Springbrook Development

Potential non-potable demand projections include the proposed Springbrook Development, to be sited within the north end of the city limits. The new development will be approximately 50 acres in size. Current plans for development provide for multiple community parks and individual residential lawns. Based upon discussions with the City, it has been estimated 50% of the development will require consistent irrigation.

To estimate irrigation demands within the Springbrook Development, the City's historical irrigation season of approximately 16 weeks is used. Using historical weekly watering data for the Newberg area as obtained from the Regional Water Providers Consortium, an average application rate of approximately 1 inch per week will be required to sufficiently irrigate turf and ornamental plants during this season. Maintaining an application rate of 1 inch per week for a full 16-week irrigation season will be equivalent to applying 1.33 feet of water over the planned irrigated areas.

Total irrigation water demands for the development may be calculated as follows:

$$\begin{aligned}\text{Annual volume of water} &= 50\% (50 \text{ acres} \times 43,560 \text{ SF/acre}) \times 16''/12 \text{ of water applied} \\ &= 50\% (2,178,000 \text{ SF}) \times 1.33 \text{ feet of water applied} \\ &= 1.45 \text{ million cubic feet} (\sim 11 \text{ MG})\end{aligned}$$

Averaged over the irrigation season, this equates to a daily demand of nearly 0.1 mgd.

Summary

This section presents existing and projected future non-potable water demands for the City's service area. Demand forecasts are developed from review of historic water use records, as well as from discussions with City staff, to determine likely future non-potable water customers. The focus of determining future demands is to estimate the potential to supply non-potable water for irrigation of residential, industrial and commercial customers.

SECTION B4 NON-POTABLE WATER DISTRIBUTION SYSTEM

This section presents alternatives for an expanded non-potable water distribution system within the City of Newberg's (City's) service area.

Existing Non-Potable Water Distribution System

The sole customer for the City's non-potable water is the Chehalem Glenn Golf Course, owned and operated by the Chehalem Park & Recreation District (CPRD). The golf course receives non-potable water from both Otis Springs and the City's waste water treatment plant (WWTP). Otis Springs water is delivered to the north end of the golf course through approximately 4,750 linear feet (LF) of 8-inch diameter pipe. Recycled water from the WWTP is routed to the southern end of the golf course through approximately 7,500 LF of City-owned 10-inch diameter pipe and 1,500 LF of privately-owned CPRD 8-inch diameter main.

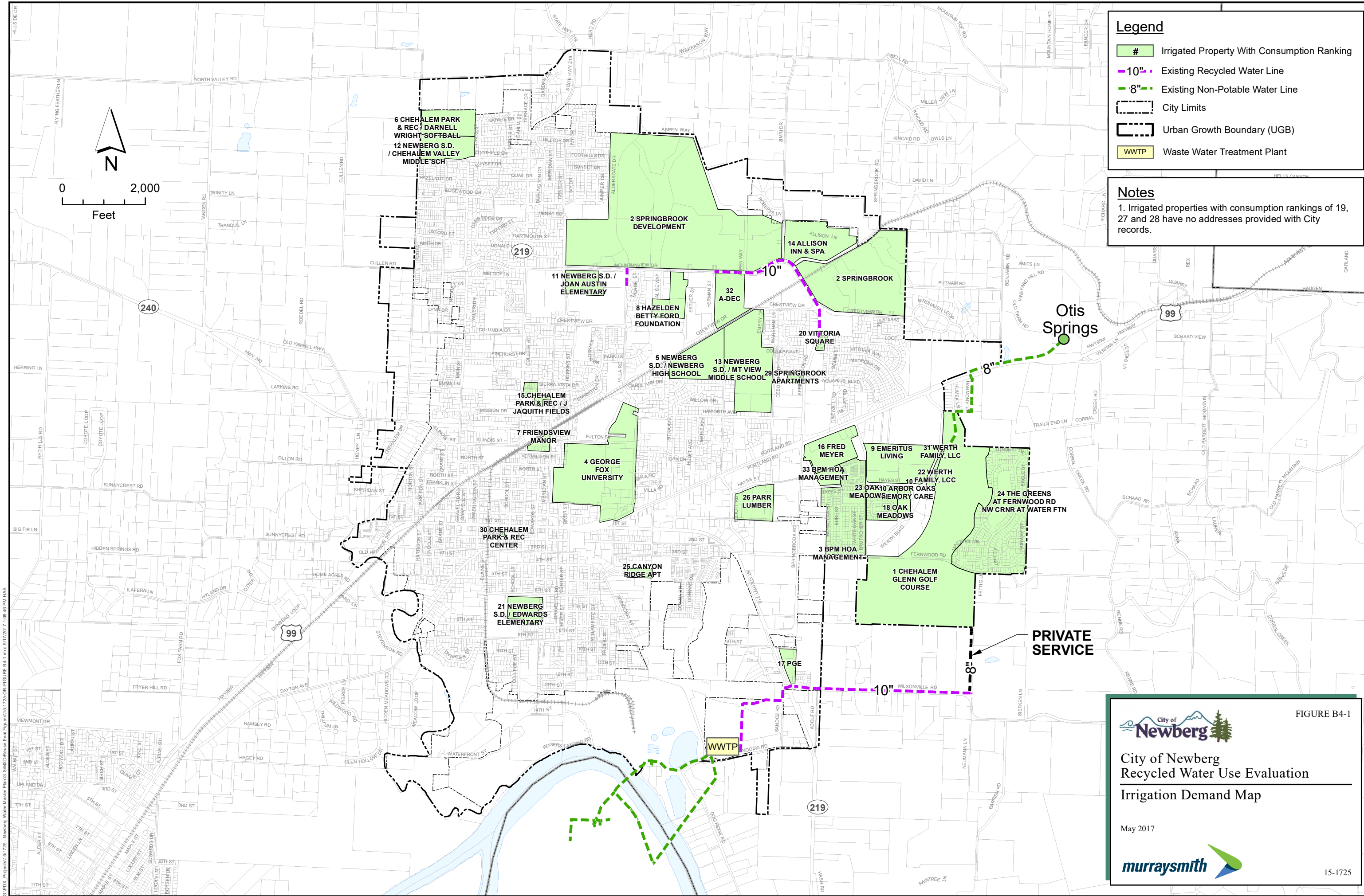
The City has also constructed numerous sections of America Water Works Association (AWWA) C900 PVC pressure pipe, colored purple to denote non-potable water use, within the northern end of the city. These sections of purple pipe have been installed over the course of several years as part of other utility improvement work completed by the City. The intention in constructing this piping has been to integrate it into a larger non-potable water distribution network in the future.

Expansion of Non-Potable Water Distribution System

The City is interested in opportunities to connect existing metered irrigation customers supplied with potable water to an expanded non-potable water system.

The locations for the City's top irrigators, including the proposed Springbrook Development, and existing non-potable water infrastructure are shown in **Figure B4-1**. Each of these properties, apart from the Chehalem Glenn Golf Course, receive irrigation water from connections to the City's potable water distribution system. Most of the properties are in the east and north sections of the city, in relatively close proximity to the City's existing non-potable water distribution system infrastructure. Expansion of the existing non-potable water distribution system should look to maximize development near existing infrastructure.

It should be noted, following any potential expansion of the City's non-potable water distribution system, there is no requirement in the City's development code for property owners to connect to this system. Since non-potable water cannot be mixed with potable water, connecting existing metered irrigation customers to an expanded non-potable water system would require improvements between meters and new and existing distribution mains. Construction costs estimated in this Section include only work associated with main line improvements and do not include improvements at meters or from new main to customer meters.



Legend

- # Irrigated Property With Consumption Ranking
- 10" Existing Recycled Water Line
- 8" Existing Non-Potable Water Line
- City Limits
- Urban Growth Boundary (UGB)
- WWTP Waste Water Treatment Plant

Notes

1. Irrigated properties with consumption rankings of 19, 27 and 28 have no addresses provided with City records.

FIGURE B4-1

City of Newberg
 Recycled Water Use Evaluation
 Irrigation Demand Map

May 2017

15-1725

Expansion Options

An evaluation was completed for the proposed expansion of the City's non-potable water distribution system. Four options for the expansion of the system were investigated. A preferred final option is provided that minimizes construction complexities, installation costs, and future operation and maintenance costs.

Option A: Do Nothing

Under this option, the City would continue to serve the Chehalem Glenn Golf Course using recycled water generated at the WWTP in combination with non-potable water from Otis Springs. No new infrastructure would be constructed, and existing capacity for recycled water production at the WWTP would not be improved. Future users near the existing non-potable water piping and supply sources may be connected to the system over time based upon their interests and willingness to pay for improvements.

There are no additional capital costs incurred by the City under this option.

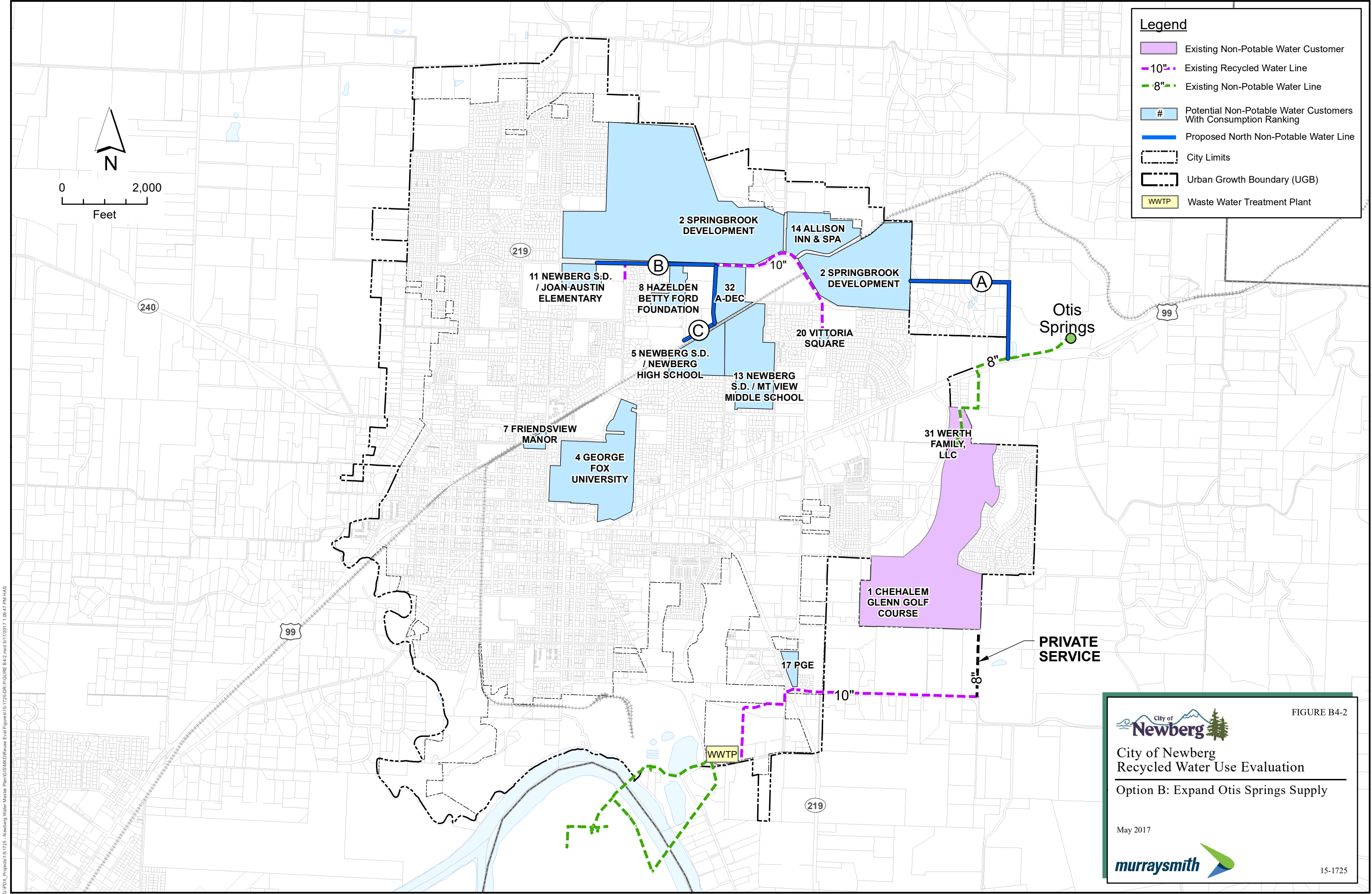
Option B: Expand Supply from Otis Springs

This option includes installation of additional piping from the Otis Springs supply line to serve existing and new development on the north end of the City, as shown in **Figure B4-2**. Average annual consumption for these properties totals approximately 22.5 million gallons (MG) or 0.2 million gallons per day (mgd). Recycled water from the WWTP would be the sole source to supply irrigation water to the Chehalem Glenn Golf Course.

Construction of the non-potable piping improvements could be completed in segments, labeled as A through C in **Figure B4-2**. Proposed piping improvements are shown within existing public right-of-way. Construction of Segment A would allow for Otis Springs supply to the proposed Springbrook Development. It is understood from discussions with City staff that conditions for development of this community would require the installation of non-potable water distribution piping to serve its various parks and residential lawns. Once the piping is installed through Springbrook Development, it may be connected to purple pipe previously installed by the City in the immediate area. Construction of Segments B and C may occur at later dates, as may be desired.

Pumping improvements at Otis Springs are recommended to replace and upgrade aged infrastructure and allow for a constant pressure pumping configuration. As the anticipated demand is well under the springs' production capacity of 0.5 mgd, there appears to be no need to construct storage onsite.


Estimated costs associated with expanding supply from Otis Springs are provided in **Table B4-2**. Full build out of this option is estimated to cost approximately \$3.6 million.




Legend

- Existing Non-Potable Water Customer
- 10" Existing Recycled Water Line
- 8" Existing Non-Potable Water Line
- # Potential Non-Potable Water Customers With Consumption Ranking
- Proposed North Non-Potable Water Line
- City Limits
- Urban Growth Boundary (UGB)
- WWTP Waste Water Treatment Plant

FIGURE B4-2


 City of Newberg
 Recycled Water Use Evaluation
 Option B: Expand Otis Springs Supply

May 2017



15-1725

G:\PDX_Projects\15-1725 - Newberg Water Master Plan\GIS\Map\Reuse Eval\Figure B4-2.mxd, 5/17/2017 1:08:47 PM HAS

**Table B4-2
Costs for Expansion Option B**

Improvements	Segment A	Segment B	Segment C	Totals
Piping ¹	\$1,350,000 (approx. 4,500 LF)	\$1,050,000 (approx. 3,500 LF)	\$750,000 (approx. 2,500 LF)	\$3,150,000
Pumping	\$400,000	--	--	\$400,000
Storage	--	--	--	--
Subtotal	\$1,750,000	\$1,050,000	\$750,000	\$3,550,000

Notes:

1: Cost estimates assume installation of 8-inch diameter AWWA C900 DR18 purple PVC piping, including appurtenances, trench backfill and surface restoration, at \$300/LF.

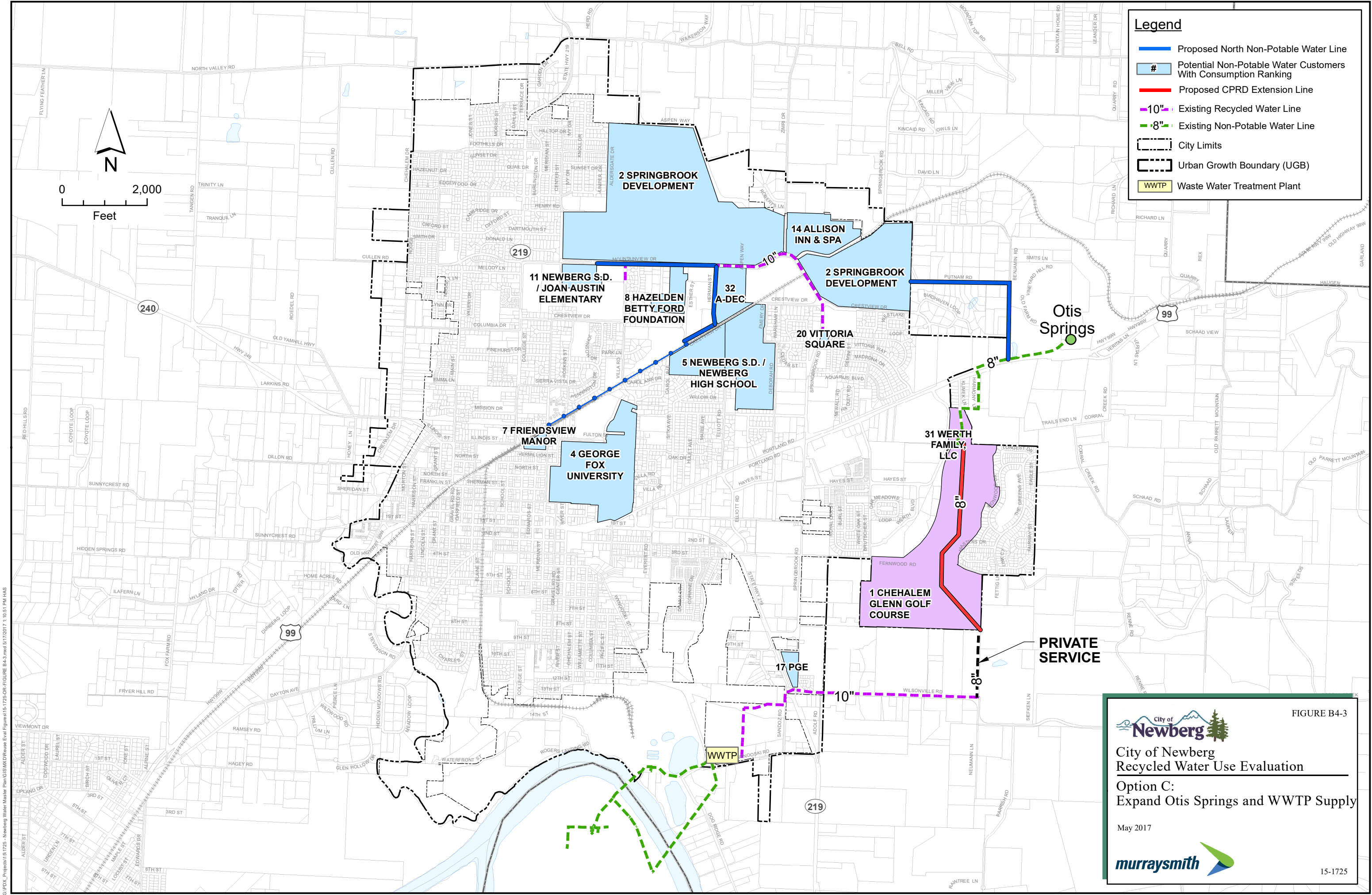
Option C: Expand Supply from Otis Springs and WWTP

This option includes installation of piping from the Otis Springs supply line to serve existing and new development on the north end of the City, as discussed with non-potable water expansion Option B. This option also includes extending CPRD’s existing private line to the Chehalem Glenn Golf Course to connect with the existing Otis Springs supply at the north end of the golf course. Piping improvements proposed with this option are shown in **Figure B4-3**. Average annual consumption for these properties, including the golf course, totals approximately 78 MG (0.7 mgd). Recycled water from the WWTP would be used in combination with Otis Springs to meet non-potable water irrigation demands for both the Chehalem Glenn Golf Course and existing residential, industrial and commercial customers.

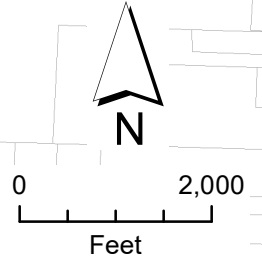
The proposed North Non-Potable Water Line could be constructed in segments, as discussed in detail for Option B. Additional piping to reach potential customers at the far west terminus of the line may require an agreement to place the line within railroad property or a re-routing of the alignment from that currently shown. Additional non-potable water irrigation customers could be added to the system following an extension of the CPRD line through the golf course.

Pumping improvements at Otis Springs are recommended to replace and upgrade aged infrastructure and allow for a constant pressure pumping configuration. Additionally, at such a time as CPRD line is extended through the golf course, modifications to existing recycled water effluent pumps may be considered. As the anticipated demand for the system is well under the combined WWTP and springs’ production capacity of 1.5 mgd, there appears to be no need to construct storage at either location.

Estimated costs associated with expanding supply from Otis Springs and the CPRD supply line are provided in **Table B4-3**. Full build out of this option is estimated to cost approximately \$6.7 million. Estimates do not incorporate costs to connect existing irrigation customers to the non-potable water main improvements. Extensive service piping to individual meters may be required to serve potential customers adjacent to the golf course.



- Legend**
- Proposed North Non-Potable Water Line
 - # Potential Non-Potable Water Customers With Consumption Ranking
 - Proposed CPRD Extension Line
 - 10" Existing Recycled Water Line
 - 8" Existing Non-Potable Water Line
 - City Limits
 - Urban Growth Boundary (UGB)
 - WWTTP



G:\PDX_Projects\15-1725 - Newberg Water Mainline Plan\GIS\Map\Output\Map\15-1725-OR-FIGURE B4-3.mxd, 5/17/2017, 1:10:51 PM HAS

FIGURE B4-3

City of Newberg
 Recycled Water Use Evaluation
 Option C:
 Expand Otis Springs and WWTTP Supply
 May 2017

15-1725

**Table B4-3
Costs for Expansion Option C**

Improvements	North Line (Segments A - C)	North Line Extension	CPRD Line Extension	Totals
Piping ¹	\$3,150,000	\$1,200,000 (approx. 4,000 LF)	\$1,500,000 (approx. 5,000 LF)	\$5,850,000
Pumping	\$400,000	--	\$400,000	\$800,000
Storage	--	--	--	--
Subtotal	\$3,550,000	\$1,200,000	\$1,900,000	\$6,650,000

Notes:

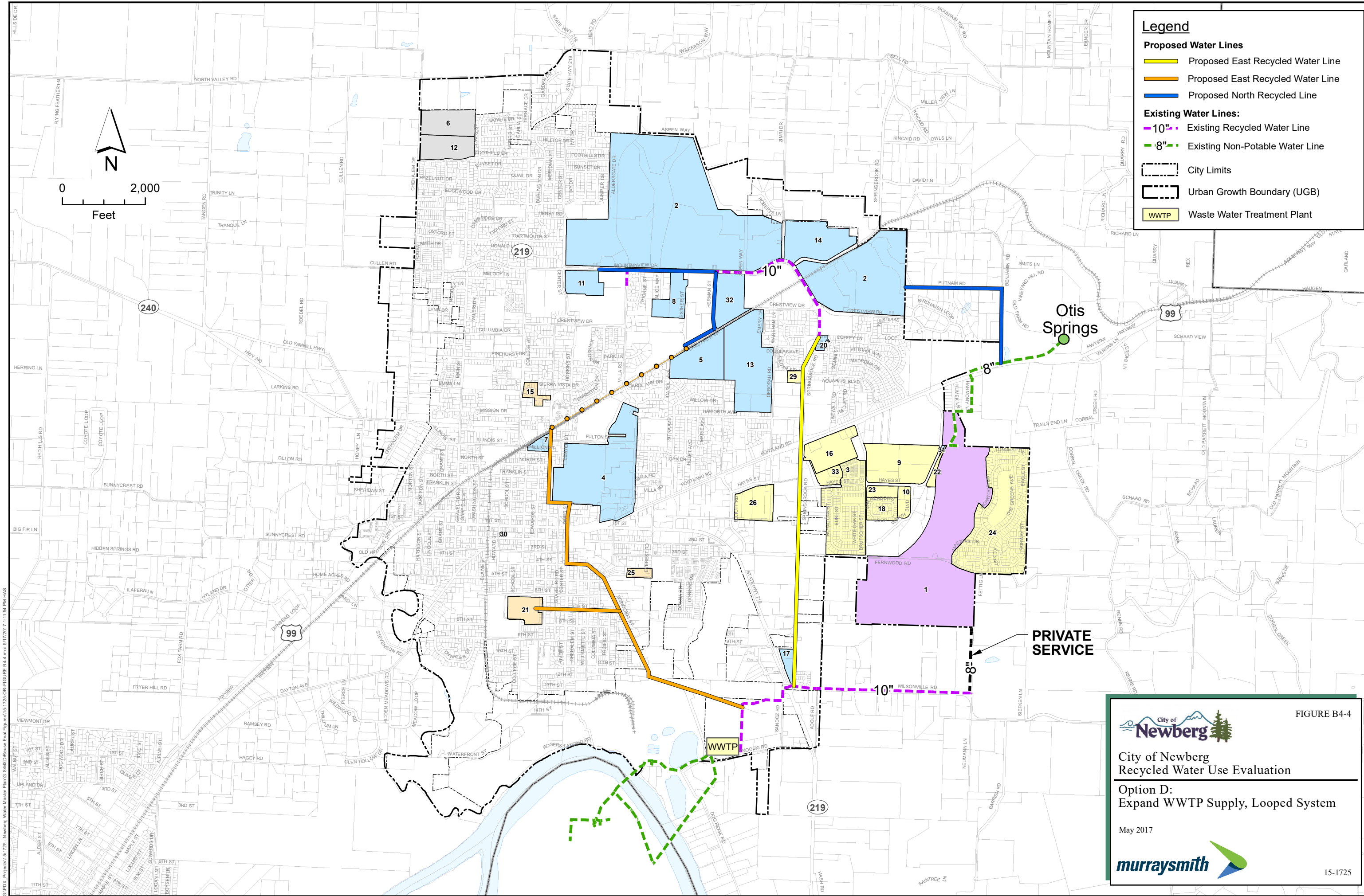
1: Cost estimates assume installation of 8-inch diameter AWWA C900 DR18 purple PVC piping, including appurtenances, trench backfill and surface restoration, at \$300/LF.

Option D: Expand WWTP Supply, Looped System

This option for expansion of the City’s non-potable water system includes development of a looped distribution network to, eventually, service all the City’s top irrigators, as shown in **Figure B4-4**. Average annual consumption of this distribution network, excluding the golf course, totals approximately 50 MG (0.45 mgd); with the golf course included, average annual consumption for the build-out non-potable water distribution system is approximately 92 MG (0.8 mgd). Under this option, Otis Springs would only provide service to the golf course.

Construction of the non-potable piping improvements will be completed in segments. Proposed piping improvements are shown within existing public right-of-way, except the western portion of the North (Blue) Recycled Water Line. In the current alignment shown for the North Recycled Water Line, an agreement to place the line within railroad property or a re-routing of the alignment will be required. The largest annual irrigation demands are found along the proposed North Recycled Water Line at approximately 23 MG (0.2 mgd). To supply the North Recycled Water Line, though, either the proposed West or East Recycled Water Line would first need to be constructed. The East (Yellow) Recycled Water Line has average annual irrigation demands of approximately 18 MG (0.15 mgd), almost twice the volume of the West (Orange) Recycled Water Line’s demands of approximately 9.5 MG (0.1 mgd). Additionally, constructing the East Recycled Water Line to supply the North Recycled Water Line distributes the greatest amount of non-potable water to customers at the lowest costs and delays the need for finding a means to connect the West Recycled Water Line to the North Recycled Water Line.

Demands for the build-out of this scenario, with or without the inclusion of supply to the golf course, do not surpass the existing 1.0 mgd capacity of the WWTP’s recycled water production facility. Upgrades to the WWTP’s recycled water production capacity, then, are not readily required under this option. However, existing recycled water effluent pumps would likely need to be reconfigured or replaced to serve the larger distribution system. If the City desires to provide a reliable source for non-potable water to irrigators under this option, it is recommended two days’ worth of storage for the system be provided at approximately



Legend

Proposed Water Lines

- Proposed East Recycled Water Line
- Proposed East Recycled Water Line
- Proposed North Recycled Line

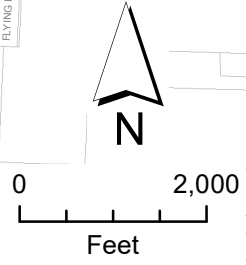
Existing Water Lines:

- 10" Existing Recycled Water Line
- 8" Existing Non-Potable Water Line

City Limits

Urban Growth Boundary (UGB)

WWTP Waste Water Treatment Plant



PRIVATE SERVICE

City of Newberg

City of Newberg
Recycled Water Use Evaluation

Option D:
Expand WWTP Supply, Looped System

May 2017

murraysmith

FIGURE B4-4

15-1725

1.6 MG. Capital costs associated with pumping and storage improvements may be phased with construction of new non-potable water distribution piping.

Estimated costs associated with expanding non-potable water supply from the WWTP are provided in **Table B4-4**. Full build out of this option is estimated to cost approximately \$11.7 million.

Table B4-4
Costs for Expansion Option D

Improvements	East (Yellow) Line	North (Blue) Line	West (Orange) Line	Totals
Piping ¹	\$2,550,000 (approx. 8,500 LF)	\$1,800,000 (approx. 6,000 LF)	\$4,500,000 (approx. 15,000 LF)	\$8,850,000
Pumping	\$400,000	\$400,000	--	\$800,000
Storage	\$1,000,000	\$1,000,000	--	\$2,000,000
Subtotal	\$3,950,000	\$3,200,000	\$4,500,000	\$11,650,000

Notes:

1: Cost estimates assume installation of 8-inch diameter AWWA C900 DR18 purple PVC piping, including appurtenances, trench backfill and surface restoration, at \$300/LF.

2: Storage estimates assume a ground-level welded steel tank.

Preferred Expansion Option

Based on the evaluation of four options for expansion of the City’s non-potable water distribution system, it appears Option B provides the City with minimal construction complexities, installation costs, and future operation and maintenance costs in comparison to other alternatives. Option B also allows the City to reconsider Option D or other expansions of the system if future opportunities for non-potable water use arise.

Summary

This section of the report presented alternatives for an expanded non-potable water distribution system within the City’s service area. A preferred expansion option for the City’s non-potable water distribution system was selected.





Water Solutions, Inc.

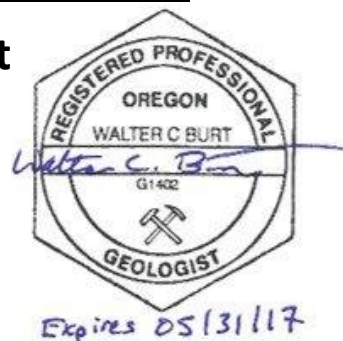
TECHNICAL MEMORANDUM

City of Newberg Supply Source Expansion Assessment

PREPARED FOR: Heidi Springer, PE – Murraysmith
Brian Ginter, PE – Murraysmith

PREPARED BY: Walt Burt, RG – GSI Water Solutions, Inc.
DeEtta Fosbury, RG – GSI Water Solutions, Inc.

DATE: January 9, 2017



Introduction

This technical memorandum (TM) summarizes GSI Water Solutions, Inc.'s (GSI) assessment of alternatives for future expansion of the City of Newberg's (City) supply source capacity. This assessment was prepared under subcontract to Murraysmith as an element of the City's 2016 water system master plan update.

The purpose of this assessment is to identify and initially evaluate potential future long-term source capacity expansion alternatives. The City's sole source of supply is its Marion County wellfield, which is located on the south side of the Willamette River, across from the City's water treatment plant (WTP) and service area. The City relies on two pipelines to convey water from the wellfield: one is suspended on an aging and now unused road bridge, and one crosses under the river. The City's highest priority objective for future source expansion is to improve its supply resiliency by developing 2 million gallons per day (mgd) of redundant capacity, ideally located on the north side (City-side) of the river. The City's preference is that at least some source capacity could be located in the northern portion of the City's service area.

This assessment focuses on the evaluation of groundwater source alternatives, although a summary of initial water rights considerations related to the feasibility of developing a surface water source of supply from the Willamette River also is included.

Background

The City has evaluated a variety of locations and technologies for supplying additional groundwater supply capacity, including evaluating the feasibility of (1) constructing a horizontal collector well (Ranney, 1993; CH2M Hill, 2000), (2) using ASR as a water management tool (CH2M Hill, 2000), and (3) expanding groundwater capacity within (Sweet, Edwards & Associates, Inc., 1983, CH2M Hill, 1992) and in the vicinity of the existing well field location (Ranney, 1980; CH2M Hill, 1997; 2000; GSI, 2006). Significant findings of these studies are summarized as follows:

- The general focus of these studies was the coarse-grained, recent alluvial sediments bordering the south and north sides of the Willamette River, although one study did evaluate the potential to develop a groundwater source within the Chehalem Valley (CH2M Hill, 1997). The study concluded that the potential for developing a groundwater source in the valley that met certain minimum capacity criteria was low.
- Locations identified as having a higher possibility for developing additional supply capacity on the basis of the potential presence of productive alluvial aquifer materials included:
 - the existing Marion County well field,
 - Ash Island,
 - areas north and east of Dundee on the north side of the river,
 - the floodplain areas adjacent to the north side of the Highway 219 bridge (Gearns Ferry),
 - Willamette Greenway State Park, located several miles east of the City.

While the alluvial aquifer is hydraulically connected to the river, the connection in the vicinity of the existing well field is limited, as evidenced by microscopic-particulate analysis (MPA) testing demonstrating that groundwater produced by the City's wells located near the river is not under the direct influence of surface water, and by high iron and manganese concentrations present in raw groundwater produced by the City's wells even after extended pumping durations. The implication of this finding is that a collector well is not a preferred alternative for capacity expansion within the City's well field.

2016 Source Expansion Evaluation

This evaluation expands on the findings of the prior studies to address the City's stated goal of 2 mgd of additional source capacity with preference for locating the capacity on the north side of the river. This evaluation considers to varying degrees three general alternatives for expanding the City's supply capacity:

1. Additional groundwater supply capacity
2. Surface water supply from the Willamette River
3. Storage using aquifer storage and recovery (ASR)

The primary factors that determine which potential groundwater source expansion and storage alternatives may be feasible include aquifer yield and water rights permitting. The feasibility of developing a surface water source involves several factors, the chief of which is the availability of water rights. This evaluation provides an initial assessment of considerations regarding water rights for a surface water source on the Willamette River, and evaluation of other factors related to a surface water source are beyond the scope of this evaluation.

While prior studies have focused primarily on the shallow alluvial aquifer, the City's source expansion priorities dictate expanding the focus of this evaluation to include consideration of other aquifers on the north side of the river. The assessment of developing additional groundwater source capacity involved two general steps: (1) identifying where the hydrogeology may be favorable for groundwater supply and/or ASR system development and where a water right can be obtained for a 2 mgd source of supply, and (2) developing potentially feasible alternatives, evaluating each relative to relevant criteria to identify benefits, risks and key uncertainties.

The remainder of this report includes the following elements:

- Description of the hydrogeology of the Newberg area to provide the basis for evaluation of the groundwater source alternatives
- Evaluation of feasibility of obtaining water rights for groundwater and Willamette River surface water sources
- Identification and evaluation of alternatives
- Summary of results

Hydrogeologic Setting

This section summarizes key aspects of the hydrogeology of the Newberg area, including the Chehalem Valley and bordering uplands (Chehalem Mountain and Parrett Mountain) to provide background and context for identifying favorable conditions for developing a 2 mgd supply and/or ASR system. The City of Newberg is bounded by the Red Hills of Dundee to the west and Parrett Mountain to the east. The Willamette River bounds the City to the south, and Chehalem Mountain is located just north of the City. The Newberg area is underlain by four major geologic units, which include (from oldest to youngest): Eocene to Miocene-age marine sediments, middle to late Miocene-age basalt flows of the Columbia River Basalt Group (CRBG), late Tertiary to early Quaternary semi-consolidated to unconsolidated (basin-fill) sediments, and Quaternary alluvial sediments near the river. The general characteristics of these units that are relevant to the potential to develop a groundwater supply source are summarized below. Figure 1 shows the general distribution of these units and mapped structures in the study area.

Marine Sediments

Marine sediments, consisting of tuffaceous and basaltic sandstone, siltstone, shale, and claystone, are exposed north and west of the City. Wells completed in this unit typically yield less than 10 gallons per minute (gpm), although locally some wells completed in fractured shale or sandstone may produce up to 200 gpm (Frank and Collins, 1978). The groundwater from this unit is generally of poor quality, containing elevated levels of total dissolved solids (TDS). This unit is not considered further as a target for source development because of poor quality water and low well yields.

CRBG

CRBG aquifers are an important source of municipal and agricultural groundwater supply in the Willamette Valley, and host several municipal ASR systems in the Tualatin Basin and City of Salem. Consequently, this evaluation took a close look at the potential feasibility of developing a groundwater source of supply or ASR system in the CRBG.

The CRBG consists of a series of laterally extensive tabular sheet basalt lava flows that originated from eruptive fissures in western Idaho and eastern Oregon and Washington, covering large areas of the Columbia River Plateau, Columbia Gorge and Willamette Valley. CRBG basalt flows typically exhibit a three-part intraflow structure: flow top, flow interior and flow bottom. The flow top and flow bottom are commonly vesicular and brecciated, which together may form relatively permeable zones that comprise the primary aquifers in the CRBG.

The CRBG in northwest Oregon consists of several individual lava flows; eleven separate flows were identified in the Parrett Mountain area by Miller et. al. (1994). The individual basalt flows range from a few feet to a few hundred feet thick, and are on average approximately 100 feet thick. The CRBG is estimated to be approximately 1,000 feet thick in the vicinity of Chehalem Mountains and Parrett Mountain. The Dundee Hills, located southwest of Newberg, also are comprised of CRBG flows, although

the section is significantly thinner than that of Chehalem and Parrett Mountains. The presence and nature of the CRBG underneath the City has not been documented.

The Chehalem Valley and south side of Chehalem Mountain define the Gales Creek/Mt Angel fault zone, a regional northwest-trending fault zone, which displaces older marine sediments against CRBG in the Chehalem Valley. Where larger faults offset water-bearing interflow zones in the CRBG, the aquifers are commonly bounded or compartmentalized. Compartmentalization limits the amount of water that can be stored in an aquifer and magnifies drawdowns in production wells. These effects limit the productivity and longer-term sustainable capacity of wells. The CRBG may be absent under portions of the City as a result of displacement by the fault. Surrounding basalt highlands are segmented by parallel northwest-trending and cross-cutting faults (Miller, et al, 1994; and Frank and Collins, 1978). As a consequence, CRBG aquifers are expected to be highly-compartmentalized, particularly under Parrett Mountain and the Dundee Hills. Declining water levels and boundary effects identified during aquifer testing in these areas are consistent with a compartmentalized aquifer system.

A review of water well logs for the general vicinity of the City indicates that well yields for the CRBG range between 5 and 450 gpm, but are generally less than 150 gpm for domestic or community supply wells. Further, the basalt aquifers in the highlands around Newberg have experienced declining water levels in response to pumping. A study completed by Miller et. al. (1994) found that groundwater levels in the CRBG in the Parrett Mountain area had declined on average 1 foot per year over the previous 14 years. The water level declines have prompted the Oregon Water Resources Department (OWRD) to designate the CRBG aquifers under Chehalem Mountain and Parrett Mountain as Groundwater Limited Areas (GWLAs; Figure 1). Limited well yields and groundwater level declines in these areas are consistent with compartmentalization of the CRBG aquifers, which has unfavorable implications both for developing a sustainable source and for implementing ASR in the CRBG.

The few basalt wells within the City limits are located mostly in the northern portion of the City, and generally yield less than 80 gpm. United States Geological Survey (USGS) regional-scale mapping suggests the possible presence of a relatively thick section of CRBG beneath the older basin-fill sediments near the Willamette River; however, the presence of basalt under the southern portion of the City is unverified, and older mapping interprets that the basalt section has been removed by faulting and erosion under a portion of the City. Additional investigation, including drilling exploratory borings near the periphery of the south and west edges of the City limits would be necessary to confirm the presence of the CRBG and to assess the viability of the CRBG aquifer(s) in this area.

In summary, well yields and the nature and distribution of the CRBG, where known to be present outside the GWLAs, suggest that the potential for drilling a supply well with a high capacity (>500 gpm) within the CRBG is low. The potential for developing a groundwater source in the CRBG in areas that have not been explored (and the CRBG potentially is absent) is highly uncertain.

Basin-Fill Sediments

This geologic unit consists of alluvial sediments deposited in the Chehalem Valley and south into the Willamette Valley, and includes the Willamette Silt and the Lower Sedimentary Unit (LSU) of Conlon, et al (2015). Within the Willamette and Chehalem valleys, this unit consists of fine-grained sediments and is typically described on well logs as blue clay with minor amounts of sand and gravel present (Conlon et. al., 2015). In the vicinity of the City, the LSU is primarily silt and clay, with occasional beds of fine sand and some gravel. The thickness of this unit varies from a few feet up to approximately 480 feet (Frank and Collins, 1978). The LSU overlies the CRBG, and where the CRBG is not present, the LSU overlies the Marine Sediments. The Willamette Silt overlies the LSU, and is generally less than 50 feet thick. Wells

completed in the basin-fill sediments typically have production rates of less than 200 gpm. On the basis of low existing well yields, the potential for developing a high yield production well within the basin-fill sediments is low.

Younger Alluvium

This unit consists of younger alluvial sediments deposited within the floodplain of the Willamette River. In the general vicinity of the City, the lower portion of this unit commonly consists of channel-derived sand and gravel, which is interlayered with and overlain by backwater/overbank-derived silt and clay. The coarser section of the unit comprises the alluvial aquifer, the most productive aquifer in the Newberg area, and is the City's source of supply for its Marion County wellfield.

The Willamette River is entrenched into older sediments in the Newberg area. The implication of this environment is that the floodplain areas where younger alluvial sediments are present are limited in extent on the outside (north) of the bend in the river as it flows past Newberg. Areas where the alluvial aquifer is confirmed or more likely to be present include: (1) within the broad floodplain that defines the inside of the riverbend on the south side of the river, and (2) in two areas on the north side of the river: including between the City and Dundee, and the area adjacent to the Highway 219 bridge, southeast of the City (Figure 1).

In most areas, the coarser-grained sediments forming the alluvial aquifer are 10 to 30 feet thick, although several investigations focused on the area surrounding the City's production wells have identified a paleochannel with up to 95 feet of coarser-grained sediments (CH2M Hill, 2000). The City's wellfield is located within and around this paleochannel (Figure 2). A thicker sequence of coarse-grained sediments also has been observed in two irrigation wells located within the area east of Highway 219 on the north side of the river. Wells completed in the alluvial aquifer typically produce water with high concentrations of iron and manganese.

Summary

Wells completed in the Marine Sediments are likely to produce low quantities of poor-quality water. Likewise, the LSU is not a productive aquifer in this area. The CRBG aquifers outside and in the northern part of the City, where known to be present, are compartmentalized, have low to medium yields, and declining water level trends. The presence, thickness, and productivity of the CRBG in the southern portion of the City is unknown. Wells completed in younger alluvium present under the Willamette River floodplain and in hydraulic connection with the river are known to produce 1,000 to 3,000 gpm, depending on seasonal variations in water levels, well construction, and the thickness and nature of the alluvium in which the well is completed. Consequently, the highest-potential alternative for developing a 2 mgd groundwater source on the north side of the river is to target the coarse material found in the younger alluvium near the Willamette River.

Water Rights Considerations

Surface Water Rights

At the request of the City, we completed a preliminary evaluation of the feasibility of obtaining a water right to develop a Willamette River surface water supply source, including obtaining a new water right and acquiring an existing right. This evaluation did not include consideration of other feasibility factors for development of a surface water source.

Obtaining a New Surface Water Permit

The following discussion evaluates the City of Newberg's ability to obtain a new surface water right authorizing the use of up to 2 mgd of surface water from the Willamette River for municipal purposes. Prior to issuing a permit, OWRD will review a surface water application to determine whether:

- 1) Water is available for the proposed use;
- 2) The proposed use is allowed in the applicable basin program administrative rules;
- 3) The use would not cause injury to other water rights; and
- 4) The use is consistent with other rules of the Water Resources Commission.

If OWRD finds that each of the criteria is met, the agency can presume that the proposed use would be in the public interest and issue a water use permit. (It is worth noting that third parties can challenge this determination as part of the permit application process.)

Based on our review of each of these criteria, as described below, GSI anticipates that OWRD would find that the proposed use of water from the Willamette River would be in the public interest, and could issue a permit for that use. As discussed below, the permit would, however, be expected to have conditions that could limit the use of water during periods of low flow.

Water Availability: To determine water availability for new surface water permits, OWRD considers its water availability analysis at 80 percent exceedance, which indicates whether the requested water would be expected to be available 8 years out of 10. Water is available in the Willamette River above the Molalla River at 80 percent exceedance each month of the year. Therefore, OWRD would find water to be available for the proposed use.

Basin Program Administrative Rules: OWRD's Willamette River basin program administrative rules identify the "classified" (allowable) uses of the water in the basin's waterways. The classified uses of water from the mainstem Willamette River below the Calapooia River (near Albany) include the use of water for municipal purposes. As a result, OWRD would find the proposed use of surface to be consistent with the Basin Program.

Injury: A new permit issued for the proposed use would be "junior in priority" to all existing water rights. Under the prior appropriation system, if insufficient water was available to meet the needs of all water users, the most junior would be regulated off until the needs of the senior water right holders were met. Based on this system, OWRD would conclude that issuance of a new permit would not cause injury to existing water rights.

Other Rules of the Commission: As part of this final assessment, OWRD will consider whether the proposed use of water is consistent with its "Division 33 rules," which are used to determine whether the use will impair or be detrimental to the public interest with regard to fish species listed under the state or federal endangered species acts. As part of this process, OWRD will request input from the Oregon Department of Fish and Wildlife (ODFW) and the Oregon Department of Environmental Quality (DEQ) about impacts of the proposed water use on listed fish and fish habitat. Based on our experience with other Willamette River permit applications, we would anticipate ODFW (and potentially DEQ) to raise some concerns about the proposed use of water and to recommend approval of the application with conditions. The most significant condition we would expect the agencies to recommend would be a condition to protect certain levels of streamflow in the Willamette River. (These target flows were identified as part of the Willamette Basin Project Biological Opinion.) The condition would only allow the diversion of water if the stream gage at Salem showed that the following target flows were met:

Time Period	Streamflow in cubic feet per second
October	5,630
November through March	6,000
April 1 to April 15	15,000
April 16 to April 30	17,000
May	15,000
June 1 to June 15	12,600
June 16 to June 30	8,500
July through September	5,630

The streamflows in the Willamette River are controlled primarily by the U.S. Army Corps of Engineers (USACE) releases of water from the Willamette Basin Project federal reservoirs. The USACE typically operates the reservoirs in a manner that causes these target flows to be met. During deficit water years, however, these target flows may not be met. In such cases, the condition recommended by ODFW would preclude the diversion of water under a new permit. In 2015, the flow targets were not met for a total of 142 days.

GSI anticipates that OWRD would issue the City a permit for the proposed use of surface water from the Willamette River. The City may, however, be unable to obtain water under the permit during periods of low flow due to conditions that are expected to be included in the permit. These conditions are being applied to new permits in order to maintain adequate stream flows during summer months. Use can be curtailed during times when the Willamette River does not meet target stream flows (as determined by the Oregon Department of Fish and Wildlife and the Oregon Department of Environmental Quality). For example, target flows were not met during the summer of 2015 for a total of 142 days.

The City should also be aware that in the Willamette Basin Program administrative rules, there are “minimum perennial streamflows” (MPSFs) for the use of stored water. At some point in the future, the MPSFs may be changed into instream water rights that would protect water released from the federal reservoirs as it flows down the Willamette River, which could possibly affect holders of Willamette River water rights. The City may want to investigate this issue further if it is seriously considering obtaining a Willamette River water right.

Obtaining an Existing Surface Water Right

An alternative to obtaining a new surface water permit would be to purchase an existing surface water right, ideally one that does not have the same conditions to which a new permit would be attached. To be acquired, the water right would need to be perfected, as evidenced by a water right certificate, and “transferred” (changed) to allow the City to use the water for municipal purposes. OWRD would evaluate a transfer application to determine whether the requested change would cause “injury” to existing water rights (prevent them from receiving water to which they are entitled) or “enlargement” (increase the amount of water that could be used under the water right). Additionally, a transfer cannot change the source of water, so water flowing past the original point of diversion must also be able to flow past the new point of diversion. A detailed analysis of a transfer would require identification and review of a water right to be transferred. Typically transferring water downstream will not be determined to cause injury or enlargement. Also, on the Willamette River it may also be possible to transfer an existing water right to a new location upstream under certain circumstances.

Groundwater Rights

Obtaining a New Groundwater Right

No new groundwater permits will be issued for municipal supply in the CRBG in the Parrett Mountain or Chehalem Mountain GWLAs, and it is unlikely that OWRD would issue a permit for a new CRBG source in the Dundee Hills. Consequently, the areas where OWRD potentially would issue a water right for the CRBG are limited. Figure 1 shows locations outside the GWLAs where CRBG has been mapped. As mentioned earlier, the presence and nature of CRBG is unknown across a broad area within and west of the City.

For the remainder of this analysis, we have assumed that the well(s) would likely be completed in the alluvial aquifer and located within one-quarter mile of, and hydraulically connected to, the Willamette River. Prior to issuing a groundwater permit, OWRD would review a permit application according to the same four criteria described above for a new surface water permit application:

- 1) Water is available for the proposed use;
- 2) The proposed use is allowed in the applicable basin program administrative rules;
- 3) The use would not cause injury to other water rights; and
- 4) The use is consistent with other rules of the Water Resources Commission.

We have evaluated each of these review criteria to determine the expected outcome of OWRD's review of a permit application requesting the use of 2 mgd of groundwater for municipal use.

Water availability: First, OWRD will evaluate whether groundwater is available for the proposed use. In performing this evaluation, OWRD will consider the water bearing unit (or aquifer) from which groundwater will be withdrawn for the proposed use, the proposed rate of water use, and any existing information OWRD has regarding the aquifer's water level (e.g., whether the aquifer water level is stable, increasing, or declining). A declining aquifer level suggests that existing groundwater withdrawals are exceeding recharge to the aquifer, which may result in OWRD making an unfavorable finding regarding groundwater availability.

In addition, OWRD will determine if the proposed use would have the potential for substantial interference (PSI) with surface water. If OWRD found PSI with surface water, it would subject the groundwater use to regulatory limitations on the adjacent surface water source, such as surface water availability. In making this determination, OWRD will first determine whether a well is developing water from a confined or unconfined aquifer. Next, OWRD will determine whether the aquifer is hydraulically connected to surface water. In making this determination, OWRD will assume that a well less than one-quarter mile from a surface water source that produces water from an unconfined aquifer is hydraulically connected to the surface water. Finally, if the well is determined to produce water from an aquifer that is hydraulically connected to surface water, OWRD will determine whether it has the potential to cause substantial interference with surface water. OWRD will assume that a use of hydraulically-connected groundwater will have PSI if it meets any of the following criteria:

1. The well is less than one-quarter mile from the surface water;
2. The well is less than one mile from the surface water, and groundwater would be appropriated at a rate greater than five cubic feet per second (cfs) ;
3. The well is less than one mile from the surface water, and groundwater would be appropriated at a rate greater than one percent of the pertinent minimum perennial streamflow, senior instream water right, or the natural streamflow that is expected 80 percent of the time; or

4. The well is less than one mile from the surface water, and groundwater appropriation for a period of 30 days would cause stream depletion greater than 25 percent of the rate of appropriation.

For a permit application to use groundwater from the alluvial aquifer, we anticipate that OWRD would find that groundwater is available. Because the alluvial aquifer is expected to have hydraulic connection with surface water, OWRD will next determine if the proposed use of groundwater would have PSI with the surface waters. Since the new well is expected to be located within one-quarter mile from the Willamette River, it is expected to have PSI with the River. As a result, limitations on the use of surface water would be applied to the new groundwater right. As previously described, however, water is available in the Willamette River above the Molalla River at 80 percent exceedance each month of the year. So surface water availability does not impose any limitations on the use of groundwater.

Basin Program Administrative Rules: OWRD's Willamette River basin program administrative rules "classify" groundwater for municipal use. In addition, because the proposed well will likely be within one-quarter mile of the Willamette River, the basin program rule classifications for surface water would also apply. As described above, the classified uses of water from the mainstem Willamette River below the Calapooia River (near Albany) include the use of water for municipal purposes. As a result, OWRD should find the use of groundwater for the proposed use to be consistent with the Basin Program rules.

Injury: Except for two irrigation wells located at the east side of the area on the north side of the river next to the Highway 219 bridge, no other wells are located in the areas of interest for an alluvial aquifer source. While the likelihood that OWRD would find the new use would cause injury if a new well(s) was installed on the west side of the floodplain area is low, this issue should be evaluated in the event the City determines to further evaluate whether to install a well(s) in this area.

Other Rules of the Water Resources Commission: Finally, OWRD will evaluate whether the proposed use of water is consistent with other OWRD administrative rules. In this case, the rules that OWRD would consider would be those related to current well construction standards and Division 33 rules (related to listed fish species).

As part of its review OWRD will evaluate whether the construction of the well proposed for use in the permit application meets current water well construction standards (as provided in the agency's administrative rules in OAR 690-210). If OWRD identifies a construction issue, OWRD will require that the construction of the well be modified to meet standards before a water use permit is issued.

As described above, OWRD will also request input from ODFW and DEQ about impacts of the proposed water use on listed fish and fish habitat. However, ODFW and DEQ typically have not recommended any additional permit conditions for groundwater applications.

The process for acquiring a new groundwater permit (assuming the application meets all of the requirements) is expected to take approximately one year. The City should secure a water right, whether through a transfer or obtaining a new permit, prior to beginning construction of a supply source. There is a high likelihood of obtaining a water right, but the City should be aware of the intrinsic risk whenever a water right transaction occurs. OWRD may impose restrictions, curtailments, or other limitations on a new water right.

Transferring an Existing Groundwater Right

The City may potentially move one or more of its existing groundwater rights to appropriate water from a well(s) on the north side of the Willamette River. To change the authorized point of appropriation (well) for an existing water right certificate, a water right transfer application must be filed with OWRD.

The agency will evaluate a transfer application to determine whether the requested change would cause “injury” to existing water rights or “enlargement.” Additionally, since a transfer cannot change the source of water appropriated, the new well would need to appropriate water from the same aquifer from which the current well appropriates water. Although the new well(s) would be located across the river from the current wells operated under the permit, OWRD is likely to conclude that the well(s) would draw from the same aquifer because the flood plain alluvial sediments are both in connection with the river.

The proposed change would not be expected to cause enlargement because use at the new well would be limited to the amount that could be used at the original well. Finally, the change would not be expected to cause injury to existing water rights. However, the City should complete additional analysis in consultation with OWRD to verify this assumption given the presence of two irrigation wells and a surface water right on Spring Brook within the same floodplain area as the CPRD properties.

Subsurface Storage Alternative: Aquifer Storage and Recovery

ASR is the underground storage of treated drinking water in a suitable aquifer and the subsequent recovery of the water from the same well or wells, generally requiring no re-treatment other than disinfection. A suitable aquifer is capable of storing sufficient volumes and supports recovery rates that meet the City’s needs. Based on the City’s goal of developing 2 mgd (1,388 gpm) of redundant capacity, and assuming a recovery period of up to 90 days, 190 million gallons of storage is needed. (OWRD typically allows recovery of up to 95 percent of the annual storage volume.) The ideal geologic setting for ASR is a confined and relatively productive aquifer of sufficient extent to accommodate the target storage volume. In the Newberg area, the basin-fill sediments and alluvial sediments are ill-suited for ASR, whereas, the CRBG hosts several operational ASR systems in Oregon.

The two most important criteria for determining whether ASR is feasible are the availability of excess treated source water for storage and the presence of a suitable aquifer. Potential challenges with other feasibility factors, such as infrastructure needs, land ownership/use and geochemical compatibility between the storage aquifer, native groundwater and ASR source water, generally can be addressed with engineered and administrative solutions.

Based on our review of the regional hydrogeology and other factors, developing an ASR system capable of delivering 2 mgd to the City for an extended period would face significant challenges. While several successful ASR systems target the CRBG in the Tualatin Basin and northern Willamette Valley, the CRBG in the highland areas surrounding the City of Newberg appears to be a faulted and highly bounded system. Compartmentalization of the CRBG aquifers have significant potential to limit achievable recovery rates and storage volumes. The compartmentalized nature of the CRBG also presents a higher risk of excessive interference with existing water users. Recently-applied OWRD conditions that commonly limit new wells completed in the CRBG to one interflow zone also may limit recovery and injection rates, thus requiring additional wells to meet capacity goals.

An order-of-magnitude estimate of the number of ASR wells needed to achieve a cumulative recovery rate of 2 mgd in the Parrett Mountain and Chehalem Mountain areas is 6 to 10, based on an initial survey of the average pumping capacities of existing higher-yielding wells (150 – 250 gpm). However, the feasibility of any particular location is highly uncertain, potentially requiring testing of many more sites to identify suitable locations. We do not recommend further evaluation of this alternative at this time because of (1) the high number of locations that would need to be tested and developed, (2) the

high cost to develop each site, including the well, ASR pump station, piping and disinfection and (3) high uncertainty regarding the suitability of the CRBG aquifers in the area for ASR.

Groundwater Supply Alternatives

This evaluation of alternatives for developing additional groundwater source capacity focuses on groundwater withdrawal from the alluvial flood plain sediments (alluvial aquifer). Consistent with findings of previous studies, the alluvial aquifer provides the City with the best opportunity for developing an additional 2 mgd of source capacity, based on current knowledge. Developing source capacity from other aquifers, including the CRBG, basin-fill sediments and marine sediments were eliminated from further consideration for the following reasons:

- The presence and suitability of the CRBG as a long-term supply source within the City is unknown and would require a significant investment to explore, and the potential for the CRBG to provide a sufficient source of supply where known to be present outside the GWLAs is low.
- Neither the basin-fill sediments nor the marine sediments appear to be able to support wells of sufficient capacity to supply the rates and quantities needed by the City.

Two basic alternatives for developing source capacity in the alluvial aquifer are available to the City. One alternative is to develop additional capacity in or near the City's Marion County wellfield on the south side of the river. This is the alternative with the highest certainty and has some other advantages. However, it does not address the City's primary objective with regards to this next increment of source capacity: to develop redundancy on the north side of the river. The second alternative is to evaluate the feasibility of developing capacity in locations where the alluvial aquifer is present on the north side of the river. This alternative accomplishes the City's objective of developing source redundancy on the north side of the river but has higher associated uncertainty.

These general alternatives were evaluated relative to two key feasibility criteria: water rights permitting and favorable hydrogeology. The more favorable alternatives identified were further evaluated for advantages and disadvantages relative to other feasibility criteria listed below:

Property Ownership and Land Use: The availability of land and land use authorization for development of a well(s). Preference is for publicly-owned parcels zoned for land uses compatible with siting a municipal water source.

Water Quality: Potential water quality and types of treatment needed. The City currently treats its groundwater supply to remove iron. The City does not currently have capabilities to treat surface water or groundwater under the direct influence of surface water.

Infrastructure: The proximity of the site(s) to treatment and distribution piping capable of conveying 1 to 2 mgd of additional supply capacity.

Source vulnerability: Proximity of known contamination or land uses with a potential to adversely affect source water quality. The former Yamhill County landfill and known Department of Environmental Quality (DEQ) cleanup sites are examples (Figure 3).

The following sections summarize the feasibility of developing a groundwater source in the alluvial aquifer and the benefits, risks and an approach to further evaluating each alternative.

Marion County Wellfield Capacity Expansion Alternative

The City completed several studies since 1980 to evaluate the potential to develop groundwater supplies from the alluvial aquifer within the floodplain on the south side of the river. The outcome of these studies was continued expansion of the City's Marion County wellfield, centered on the thickest known section of saturated aquifer. The City has fully developed the pumping capacity of the majority of this channel feature, although the capacities of two wells (4 and 5) are diminished, potentially because of biofouling. While the aquifer becomes appreciably thinner northwest and south of the wellfield (Figure 2), the thickness and nature of the aquifer and potential presence of additional channel features have not been fully explored on the south end of the City's parcel, nor in the northerly portions of the adjacent parcel. The presence of undeveloped alluvial aquifer on the City's parcel and adjacent areas, and the diminished capacity of the City's older wells (particularly Well 4) present a couple of potential opportunities for developing additional capacity on the south side of the river, which could be implemented independently or collectively:

- 1) Evaluate whether the capacities of Well 4 and Well 5 can be restored and/or whether replacing Well 4 would be beneficial
- 2) Fully explore the City's parcel and nearby areas, and drill a new well(s) based on the results of this assessment

While additional source capacity within or near the City's Marion County wellfield does not address the City's primary objective of developing 2 mgd of redundancy on the north side of the river to improve system resiliency, the alternative has a few inherent advantages:

- The City owns the parcel occupied by the wellfield and has existing land use approvals to utilize the parcel, which is designated for exclusive farm use (EFU), for municipal drinking water source.
- Much of the access, power and conveyance infrastructure necessary to add capacity is already in place.
- The City holds undeveloped water right capacity for this aquifer, and changes to the City's water rights to add or move well locations should be relatively simple.

The primary disadvantage of this alternative is that this redundant capacity also would rely on the conveyance across the river and not provide the level of resiliency the City seeks by locating redundant capacity on the north side of the river. Another disadvantage is that the yield of individual wells may be lower than the City's existing wells, resulting in a higher cost per unit capacity. The approach and general steps for developing additional source capacity in or near the Marion County wellfield are summarized below:

Improve/Replace Existing Wells

This option would involve evaluating whether the performance of older existing wells 4 and 5 could be restored to improve overall source capacity, and if not, whether the City should consider replacing Well 4. The performance and capacities of wells 4 and 5 have been significantly diminished since originally installed. Recent advances in well assessment and rehabilitation methods may better inform the City whether to continue to operate these assets as-is or consider implementing a thorough and structured rehabilitation program to restore their capacity. One possible conclusion of the assessment would be that completing a comprehensive rehabilitation program would not be worthwhile. The evaluation could also include an assessment of whether replacing Well 4 would significantly improve overall source

capacity given that Well 4 is located at a sufficient distance from the remainder of the wells such that it would be less affected by interference from other wells.

Implementation of this option would include the following steps:

- 1) Complete a comprehensive assessment of Well 4 and potentially Well 5 to develop a full understanding of the causes of well fouling and diminished well performance. The assessment would initially involve review of information from prior assessment and rehabilitation efforts, including well videos, performance testing, water quality data and rehabilitation methodologies used. The information review would be followed by targeted water quality and bacteriological testing, and possibly a well video survey
- 2) Develop a structured rehabilitation program to target the mechanisms of fouling and evaluate potential effectiveness
- 3) Evaluate potential capacity gains to be achieved by replacing Well 4
- 4) Complete a cost/benefit analysis
- 5) Implement a structured rehabilitation program, depending on results of cost/benefit analysis

Drill New Wells on City or Adjacent Parcel

CH2M Hill (1992) estimated that the capacity of a new well drilled within the thinner (~20 feet) section of the alluvial aquifer would be between 450 and 700 gpm. However, the well capacity potential for certain portions of the City's parcel and the adjacent western parcel is not well understood because the depth, thickness and nature of the alluvial aquifer has not been fully explored. This option would involve filling in gaps in knowledge of the thickness of the alluvial aquifer on the City's parcel and developing the desired capacity increment by installing wells in the most advantageous locations on the basis of well capacity, property, permitting and infrastructure (power and conveyance) costs. The initial phase of this option would explore the extent and thickness of the aquifer on the adjacent parcel to fully understand the resource capacity of the parcels:

- 1) Negotiate an agreement with the owner of the parcel adjacent to the City's property.
- 2) Conduct a surface geophysical survey using time-domain electromagnetic (TDEM) methods, which has been proven effective at identifying and quantifying the thickness of the alluvial aquifer in environment of the Marion County wellfield.
- 3) Identify the most promising locations for installing a well(s) based on aquifer thickness and well interference.
- 4) Install a test boring to confirm the select location(s) is favorable for a production well
- 5) Develop a cost/benefit analysis based on projected well capacity and costs for permitting, installing a production well, installing the pumping system and controls, and connecting the well to the conveyance system.
- 6) Amend the City's groundwater permit to move or add the prospective well locations.
- 7) Install, test, and connect one or more production wells, as needed

North Side Capacity Expansion Alternative

This alternative involves developing source capacity in the alluvial aquifer on the north side of the river. Target areas for exploring the presence and nature of the alluvial aquifer include: (1) the floodplain on either side of Highway 219, termed the Gearns Ferry Area, and (2) the floodplain between Rogers Landing County Park (Rogers Landing) and the City of Dundee, referred to below as the Southwestern Area. The general locations of these areas are shown in figures 1 and 3.

Prior studies also identified Willamette Greenway State Park as an additional alternative for developing a source on the north side of the river. However, the park is located approximately 4 miles east of the City, and because of the high cost to install conveyance to the water treatment plant is not considered further in this evaluation.

Developing source capacity at one of these two locations addresses the City's primary objective of developing 2 mgd of redundancy on the north side of the river to improve system resiliency. Other advantages include the availability of publicly-owned property, and water rights currently held by the City could be utilized for wells completed in the alluvial aquifer. Also, wells completed in the vicinity of the Gearns Ferry Area indicate productive aquifer materials are present at least in some areas. However, potential well yields and water quality at the possible target are uncertain because neither location has been adequately explored. Past and present land uses at both locations require further evaluation to understand whether they pose a potential risk to source water quality. Both areas would require installing up to a mile of piping to convey raw water from the areas to the City's water treatment plant. A summary of the issues and general steps associated with evaluating and developing additional source capacity in the target areas on the north side of the river are summarized below.

Gearns Ferry Area

The Gearns Ferry Area was identified during previous groundwater supply studies as potentially having favorable conditions for developing a groundwater supply source from the alluvial aquifer (CH2M Hill, 1997). The Gearns Ferry Area includes two parcels owned by Chehalem Parks and Recreation District (CPRD) adjacent to the east and west sides of Highway 219 (Figure 4). The remainder of the Gearns Ferry Area is privately-owned. Nearly all of the floodplain is in cultivation, and the land is designated EFU.

The City completed a limited evaluation of the groundwater supply potential of the eastern portion of the CPRD property in 2006 (GSI, 2006), based on the identification of productive aquifer conditions in two irrigation wells located on the Willamette Farms property to the east of the CPRD parcel and an irrigation/domestic well located to the west (Figure 4). The investigation included drilling an exploratory borehole on the east edge of the CPRD property and water quality testing of the Willamette Farms wells. Although the test borehole did not intercept a thick sequence of productive material, the majority of the CPRD property remains unexplored and appears to have potential to host a thicker sequence of productive alluvial aquifer materials. The 2006 investigation did identify the presence of cyanide in a sample from one of the Willamette Farms wells, most likely a residue from agricultural chemical use. Consequently, additional investigation of groundwater quality and current agricultural practices at the Willamette Farms and CPRD parcels, as well as water quality testing on the CPRD site, would be necessary to assess the risks to source water quality prior to investing in a supply source at this location.

As indicated above, further investigation is necessary to evaluate the feasibility of developing a groundwater source at the CPRD property to address the two primary data gaps: (1) verify the presence and pumping capacity of the aquifer, and estimate well yields; and (2) evaluate groundwater quality and current and potential future agricultural practices to assess risks to source water quality. We recommend the following approach for the feasibility evaluation:

1. Meet with OWRD hydrogeologists and permit specialists to review any potential concerns or constraints to be addressed in applying for a transfer to add a new well(s) at this location to the City's existing water rights.
2. Complete a surface geophysical survey (TDEM) of the CPRD property to identify the distribution, depth and thickness of coarse-grained alluvial aquifer materials.
3. Sample the Willamette Farms and any other identified wells completed in alluvial aquifer, and analyze for a complete suite of inorganic and synthetic organic compounds, including pesticides, fungicides and herbicides.
4. Conduct outreach to the adjacent landowners to gage support for a wellfield project on EFU land
5. Interview owners/managers of adjacent properties and lessees of the CPRD property to review current and planned future farm practices.
6. Drill two to three test borings using roto sonic techniques to verify the results of the geophysical survey, collect water quality samples and identify a location(s) for advancing a test well. The test borings will target locations where geophysics indicates a substantial thickness of alluvial aquifer is present at least 200 feet from the river to avoid the presumption that groundwater is under the direct influence of surface water, and therefore requires treatment.
7. Complete a test well and complete a long-term aquifer test and water quality sampling.
8. Should the results of the investigations demonstrate that the desired capacity of acceptable quality can be developed, prepare a conceptual design and costs for a well(s), pump and controls, conveyance and treatment plant upgrades to bring the new source online.
9. Submit a transfer application to add a new well(s) to one of the City's existing alluvial aquifer water rights.

Southwest Area

The Southwest Area encompassing the floodplain between Rogers Landing and the City of Dundee is the other proximal area with potentially-favorable hydrogeologic conditions for development of a groundwater source of supply in the alluvial aquifer on the north side of the river (Figure 5). However, this particular area has several challenges and thus is less preferable than the Gearn's Ferry area. First, little information is available from which to assess the yield potential in this area. Also, the only publicly-owned property potentially suitable for development of a groundwater source is the Rogers Landing, located at the north end of the floodplain. A closed landfill is located between Rogers Landing and Dundee, approximately ¼-mile from the western edge of the park. The potential for contamination related to the landfill to affect a groundwater source installed in this area requires scrutiny. The land located between the landfill and the City of Dundee is privately-held agricultural land designated EFU, which may present some access and land use challenges.

Similar to the CPRD property, further investigation is necessary to evaluate the feasibility of developing a groundwater source in the Southwestern Area to address two primary data gaps: (1) verify the presence and pumping capacity of the aquifer, and estimate well yields; and (2) evaluate groundwater quality, potential landfill impacts, and current and potential future agricultural practices to assess risks to source water quality. We recommend the following approach to evaluate the feasibility of developing a groundwater source in the Southwest Area:

1. Complete a surface geophysical survey (TDEM) of the select location to identify the distribution, depth and thickness of coarse-grained alluvial aquifer materials.
2. Conduct outreach to the adjacent landowners to gage support for a wellfield project on EFU land.
3. Interview owners/managers of adjacent agricultural properties to review current and planned future farm practices.
4. Drill two to three test borings to verify the results of the geophysical survey, collect water quality samples and identify a location(s) for advancing a test well. The test borings will target locations where geophysics indicates a substantial thickness of alluvial aquifer is present at least 200 feet from the river to avoid the presumption that groundwater is under the direct influence of surface water, and therefore requires treatment.
5. Complete a test well and complete a long-term aquifer test and water quality sampling.
6. Should the results of the investigations demonstrate that the desired capacity of acceptable quality can be developed, prepare a conceptual design and costs for a well(s), pump and controls, conveyance and treatment plant upgrades to bring the new source online.
7. Submit an application to add a new well(s) to one of the City's existing alluvial aquifer water rights.

Summary

The City desires to develop 2 mgd of new source capacity to provide redundancy and service future growth. Ideally, the new source capacity would be located on the north side of the river to improve system resiliency by reducing dependence on the City's sole source of supply, the Marion County wellfield, which is located across the Willamette River. While this evaluation is focused primarily on groundwater source alternatives, three general alternatives for developing additional source capacity were assessed varying degrees. The general alternatives and scope of this evaluation for each are as follows

1. New Willamette River surface water supply: evaluation of water rights considerations only
2. Subsurface storage using ASR: initial desktop assessment of the potential to develop an ASR system with 2 mgd of recovery capacity based on hydrogeological conditions
3. Additional groundwater source capacity: identification and evaluation of alternatives for expanding the capacity for the City's existing Marion County wellfield and developing a new groundwater source on the north side of the river, including water rights considerations and roadmaps for implementation

Willamette River Surface Water Source

The assessment of the potential to develop a surface water source from the Willamette River was limited to a review of water rights considerations. At present GSI anticipates that OWRD would issue the City a new permit for the proposed use of surface water from the Willamette River. The City may, however, be unable to obtain water under the permit during periods of low flow due to conditions that are expected to be included in the permit. Use can be curtailed during times when the Willamette River does not meet target stream flows (as determined by the Oregon Department of Fish and Wildlife and

the Oregon Department of Environmental Quality). For example, target flows were not met during the summer of 2015 for a total of 142 days.

An alternative to obtaining a new surface water permit would be to purchase an existing surface water right, ideally one that does not have the same conditions to which a new permit would be attached. A detailed analysis of a transfer would require identification and review of a water right to be transferred. Typically transferring water downstream will not be determined to cause injury or enlargement. Also, on the Willamette River it may also be possible to transfer an existing water right to a new location upstream under certain circumstances. In the absence of viable subsurface storage options, the City's most reliable alternative for developing a surface supply would be to identify and transfer an existing, certificated water right.

Subsurface Storage using ASR

Based on our review of the regional hydrogeology and other factors, developing an ASR system capable of delivering 2 mgd to the City for an extended period would face significant challenges. An order-of-magnitude estimate of the number of ASR wells needed to achieve a cumulative recovery rate of 2 mgd in the Parrett Mountain and Chehalem Mountain areas is 6 to 10, based on an initial survey of the average pumping capacities of existing higher-yielding wells (150 – 250 gpm). However, the feasibility of any particular location is highly uncertain, potentially requiring testing of many more sites to identify suitable locations. Implementation of this alternative would entail acquiring a sufficient number of suitable sites, testing each site and developing suitable sites. Assuming feasible based on site availability and hydrogeological conditions, the cost of each increment of capacity would likely be prohibitive. , For these reasons, we do not recommend further evaluation of this alternative at this time.

Groundwater Supply Development

Of the four primary aquifer systems in the Newberg area, only the alluvial aquifer, present within the Willamette River floodplain, appears to have the potential to develop a 2 mgd supply. Two potential alternatives for development of the desired capacity from the Alluvial Aquifer are available to the City:

1. Enhance and expand the capacity of the existing Marion County wellfield by rehabilitating or replacing existing underperforming wells and/or developing new wells on undeveloped portions of the City's or adjacent properties.
2. Develop a new source of supply on the north side of the river at one of two locations where the Alluvial Aquifer appears to be present: the Southwestern and the Gearn's Ferry areas.

Enhance or Expand Capacity of Marion County Wellfield

This alternative includes several intrinsic advantages, including the presence of existing conveyance, property ownership and somewhat less uncertainty about the hydrogeological conditions. However, the City's resiliency objective is not addressed by developing additional capacity on the south side of the river. This general alternative includes two options, (1) rehabilitate and/or replace existing wells to increase capacity, or (2) drill new wells in undeveloped portions of the City's parcel or the adjacent parcel located to the west. Both options could be implemented with only minor modifications to the City's existing water rights.

Rehabilitate and/or replace existing wells: This option would involve evaluating whether the performance of older existing wells 4 and 5 could be restored to improve overall source capacity, and if not, whether the City should consider replacing Well 4. An advantage of this option is that it could maximize the utility of existing wells and distribution infrastructure.

Drill new wells on City or adjacent parcel: This option would involve filling in gaps in knowledge of the thickness and permeability of the alluvial aquifer for certain portions of the City's parcel and the adjacent western parcel, and developing the desired capacity increment by installing wells in the most advantageous locations on the basis of well capacity, property, permitting and infrastructure (power and conveyance) costs.

North Side Capacity Expansion Alternative

This alternative involves developing source capacity in the alluvial aquifer on the north side of the river in either the Gearns Ferry Area, or the Southwestern Area (figures 1 and 3). Developing source capacity at one of these two locations addresses the City's primary objective of developing 2 mgd of redundancy on the north side of the river to improve system resiliency. Other advantages include the availability of publicly-owned property, and water rights currently held by the City could be utilized for wells completed in the alluvial aquifer. Also, wells completed in the vicinity of the Gearns Ferry Area indicate productive aquifer materials are present at least in some areas. However, potential well yields and water quality at the possible target are uncertain because neither location has been adequately explored. Past and present land uses at both locations require further evaluation to understand whether they pose a potential risk to source water quality. Both areas would require installing up to a mile of piping to convey raw water from the areas to the City's water treatment plant.

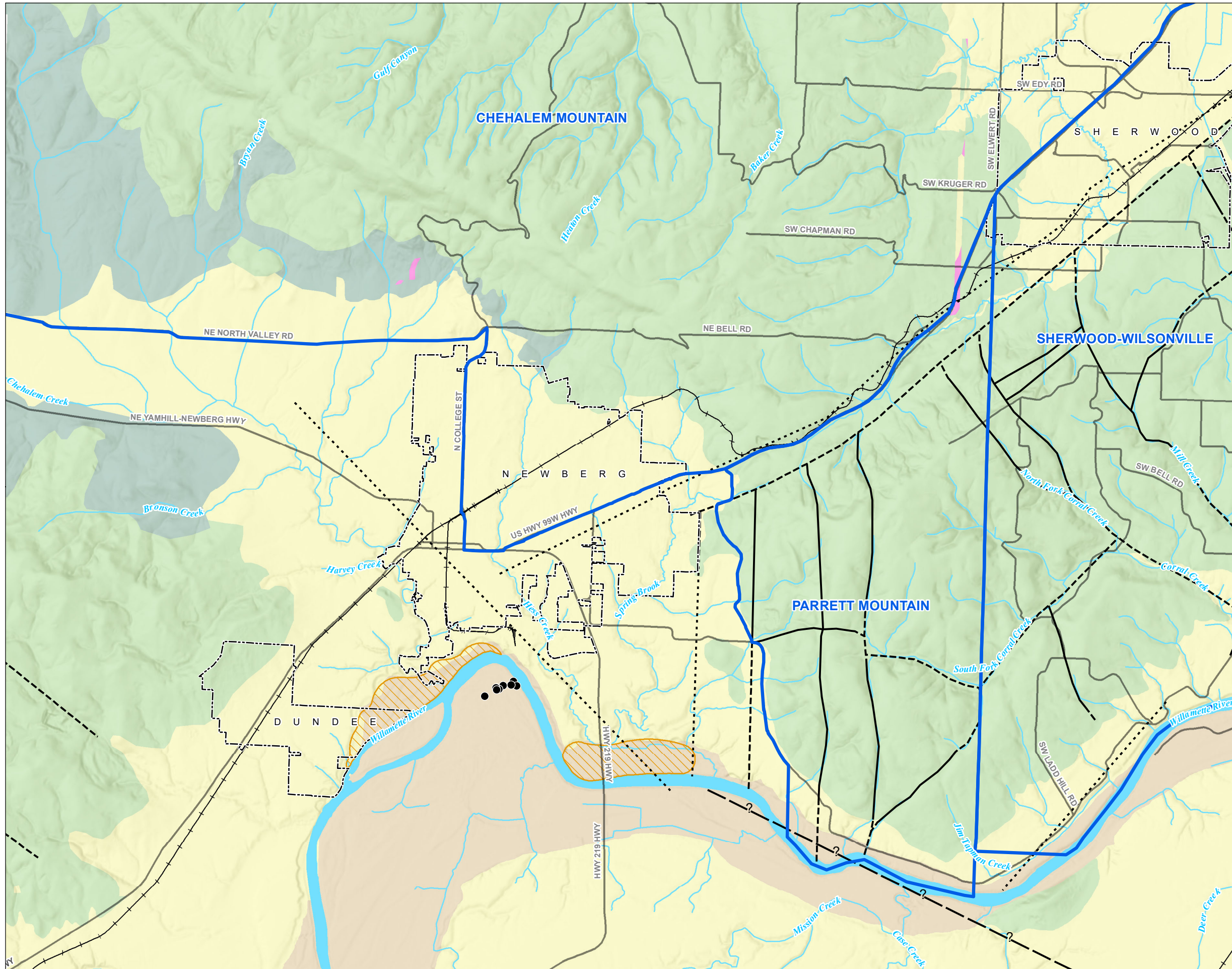
References

- CH2M Hill, 1992. City of Newberg, well field evaluation study. Report dated October 1, 1992.
- CH2M Hill, 1993. City of Newberg Ranney collector feasibility study. Report dated December 22, 1993.
- CH2M Hill, 1997. City of Newberg preliminary groundwater availability study. Technical memorandum dated July 17, 1997.
- CH2M Hill, 2000. Newberg wellfield exploration, test well installation, pump test, and well interference analysis. Report dated March 9, 2000.
- Conlon, T.D., Wozniak, K.C., Woodcock, D., Herrera, N.B., Fisher, B.J., Morgan, D.S., Lee, K.L., and Hinkle, S.R. Ground-water hydrology of the Willamette Basin, Oregon. U.S. Geological Survey Scientific Investigations Report 2005-5168, 83 p.
- Frank, F.J. and C.A. Collins, 1978. Groundwater in the Newberg Area, Northern Willamette Valley, Oregon. U.S. Geological Survey and State of Oregon Water Resources Department, Groundwater Report No. 27.
- GSI, 2006. Gearns Ferry property investigation. Memorandum from Jeff Barry to Dan Danicic, City of Newberg.
- Miller, D.W., Gates, S.M., Brodersen, B.T., and Zwart, M.J., 1994. Groundwater conditions of basalt aquifers, Parrett Mountain, Northwestern Willamette Valley, Oregon: Oregon Water Resources Department, Groundwater Report 40, 144 p.
- Ranney Method Western Corporation, 1980. Tigard Water District hydrogeological survey – Ranney collector feasibility report. Consultant report to Tigard Water District.
- Sweet, Edwards & Associates, Inc., 1983. Newberg well field hydrogeologic study. Consultant report submitted to Kramer, Chin & Mayo, Inc.

Figures

This page intentionally left blank.

FIGURE 1
Geologic Setting
 Expansion Assessment
 Newberg, Oregon



LEGEND

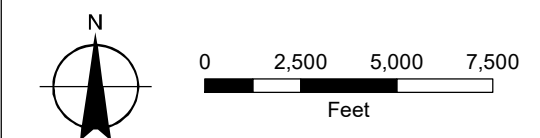
Surficial Geology

- Floodplain Deposits of the Willamette River and Major Tributaries (Younger Alluvium)
- Quarternary Alluvium (Basin-Fill)
- Tertiary Sedimentary Rocks (Basin-Fill Sediments)
- Columbia River Basalt Group (CRBG)
- Marine Sediments
- Normal Fault
- Approximate Fault
- Concealed Fault
- Uncertain Fault

All Other Features

- City Production Well
- Potential Alluvial Aquifer Source Location
- OWRD Groundwater Limited Area
- Cities
- Major Road
- Railroad
- Watercourse
- Waterbody

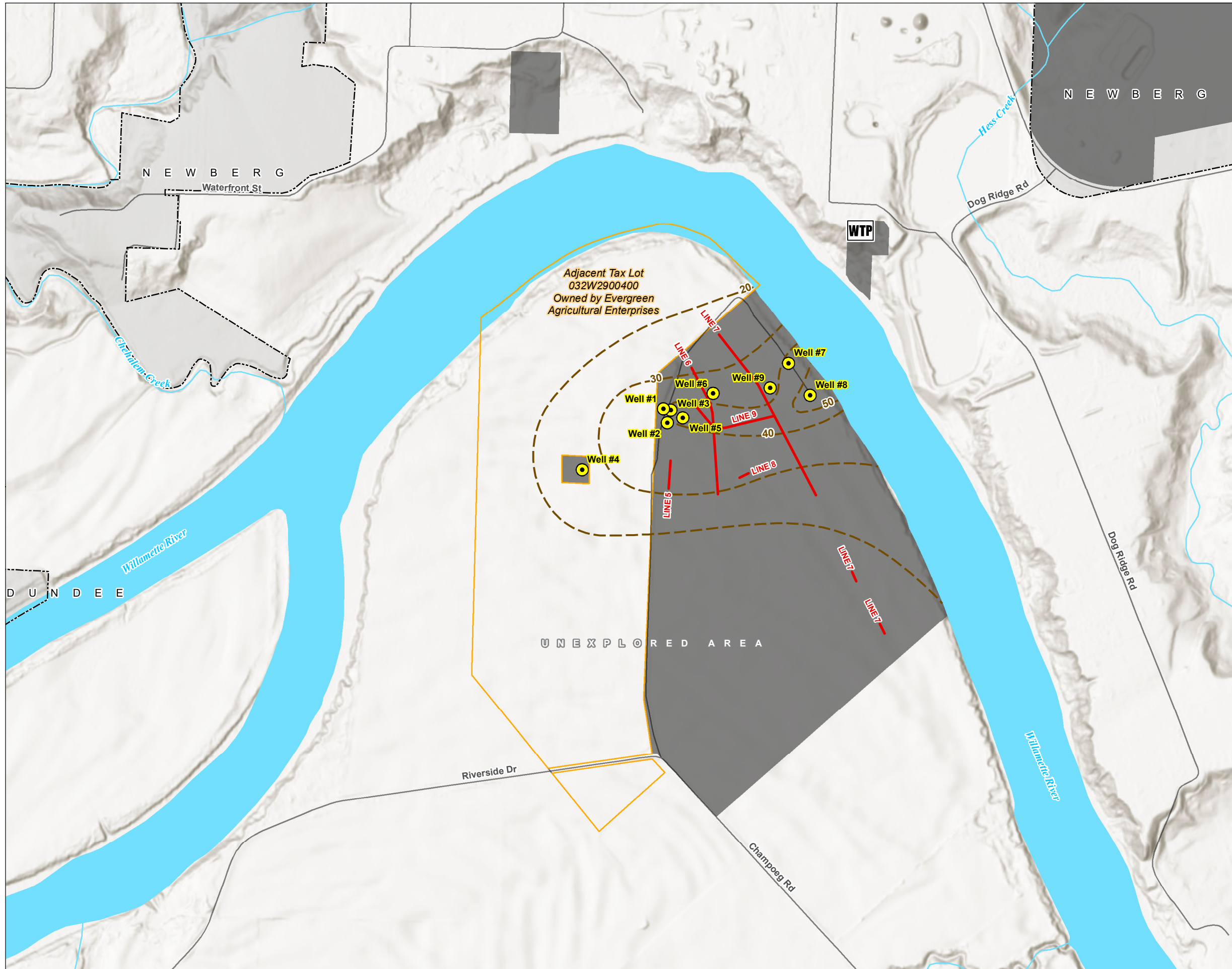
NOTE:
 Fault lines digitized from USGS PP-1424-A and OWRD Groundwater Report No. 40 (Miller, D.W., et al., 1994, Groundwater Conditions of Basalt Aquifers, Parrett Mountain, Northern Willamette Valley, Oregon).



MAP NOTES:
 Date: May 27, 2016
 Data Sources: Newberg, OWRD, DOGAMI, METRO, RLIS

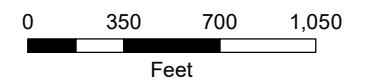


FIGURE 2
Geophysical Investigations
 Expansion Assessment
 Newberg, Oregon



LEGEND

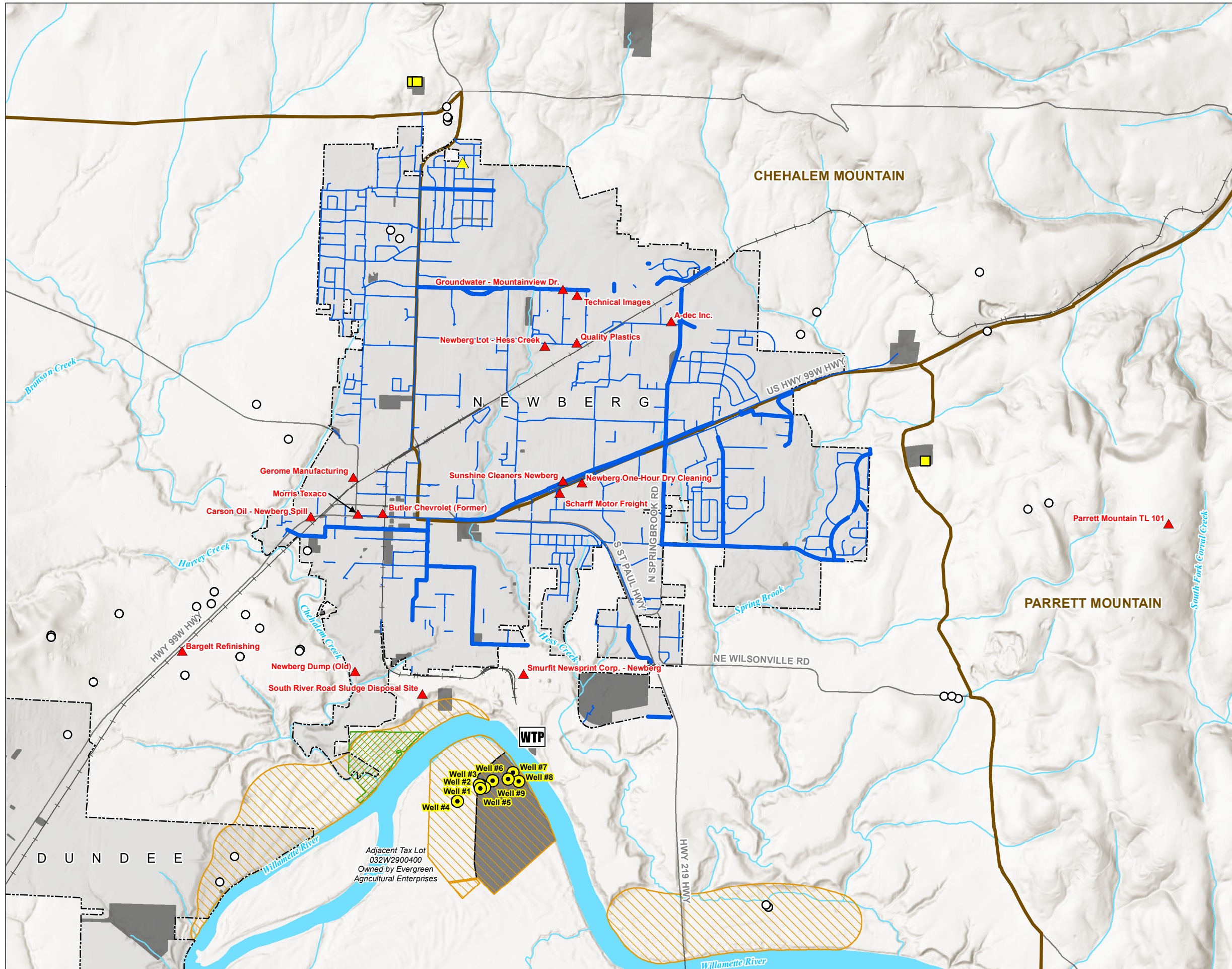
- Production Well
- Geophysical Investigation Location
- Estimated Thickness (feet) of Coarse-Grained Deposits (CH2M, 1992)
- Newberg Water Treatment Plant
- Cities
- City-Owned Tax Lot
- Adjacent Tax Lot
- Major Road
- Watercourse
- Waterbody



MAP NOTES:
 Date: May 27, 2016
 Data Sources: Newberg, Yamhill Co GIS, Marion Co GIS, METRO RLIS, CH2MHILL Well Field Study (1992)



FIGURE 3
Potential Source Expansion Areas
 Expansion Assessment
 Newberg, Oregon



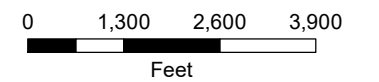
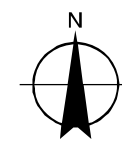
LEGEND

Distribution System

- Production Well
- Pump Station
- Enclosed Storage Facility
- Newberg Water Treatment Plant
- 8, 9, and 10 inch diameter water main (capable of distributing 700 gpm [1 MGD])
- 10 inch diameter water main (capable of distributing more than 800 gpm)

All Other Features

- DEQ ECSI Site
- Potential Alluvial Aquifer Source Location
- Groundwater Right Point of Appropriation (POA)
- Approximate Former Yamhill County Landfill
- OWRD Groundwater Limited Areas
- Cities
- City-Owned Tax Lot
- Adjacent Tax Lot to Wellfield
- Major Road
- Railroad
- Watercourse
- Waterbody

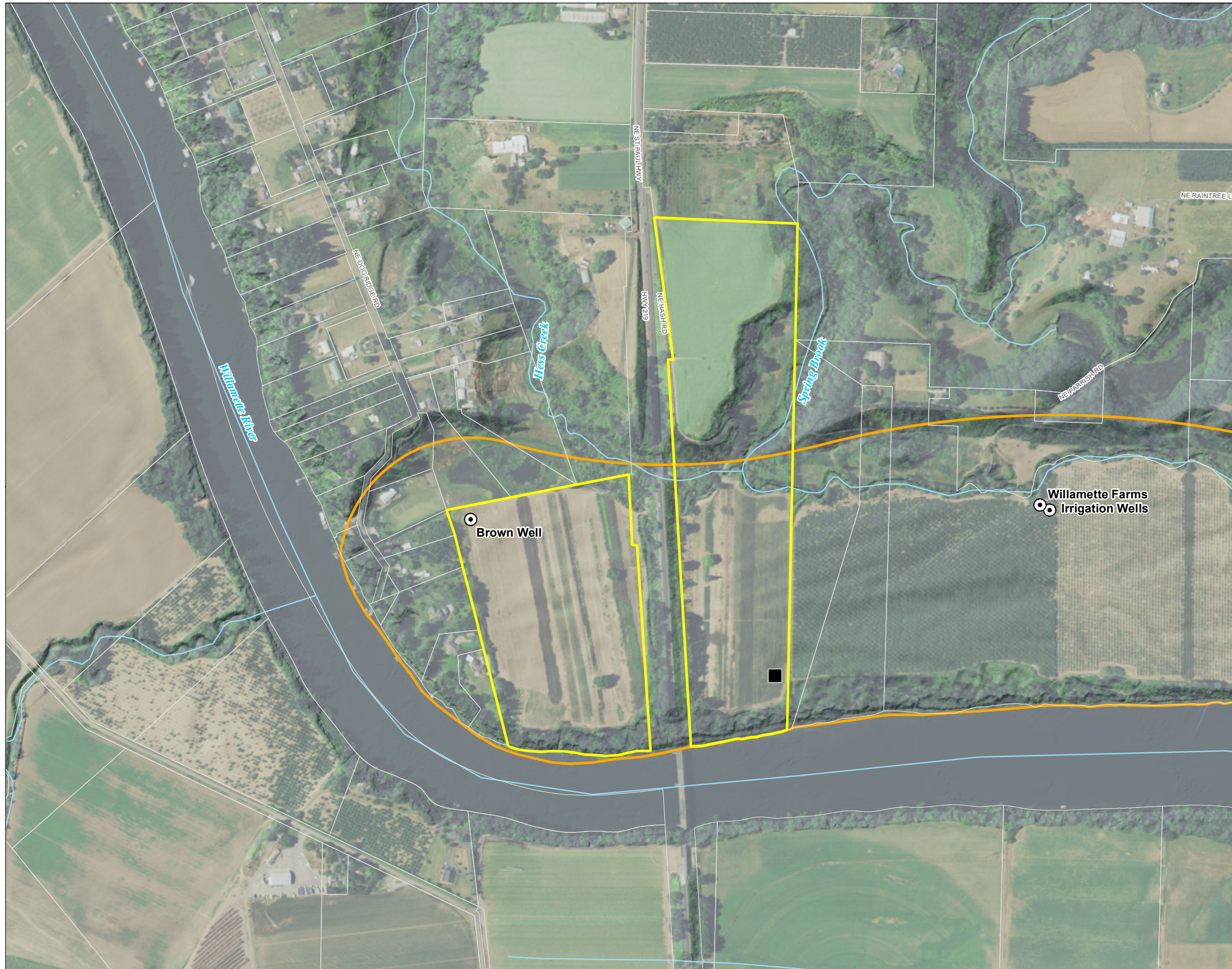


MAP NOTES:

Date: May 31, 2016
 Data Sources: Newberg, OWRD, OR DEQ, Yamhill Co GIS, Marion Co GIS, METRO RLIS

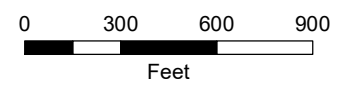
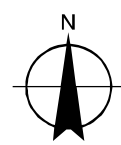


FIGURE 4
Gearns Ferry Site
 Expansion Assessment
 Newberg, Oregon



LEGEND

- Location of GSI Gearns Ferry Investigation (2006)
- Existing Well
- ▭ Tax Lot Owned by Chehalem Valley Parks and Recreation District
- ▭ All Other Tax Lots
- ▭ Potential Alluvial Aquifer Source Location
- ~ Watercourse

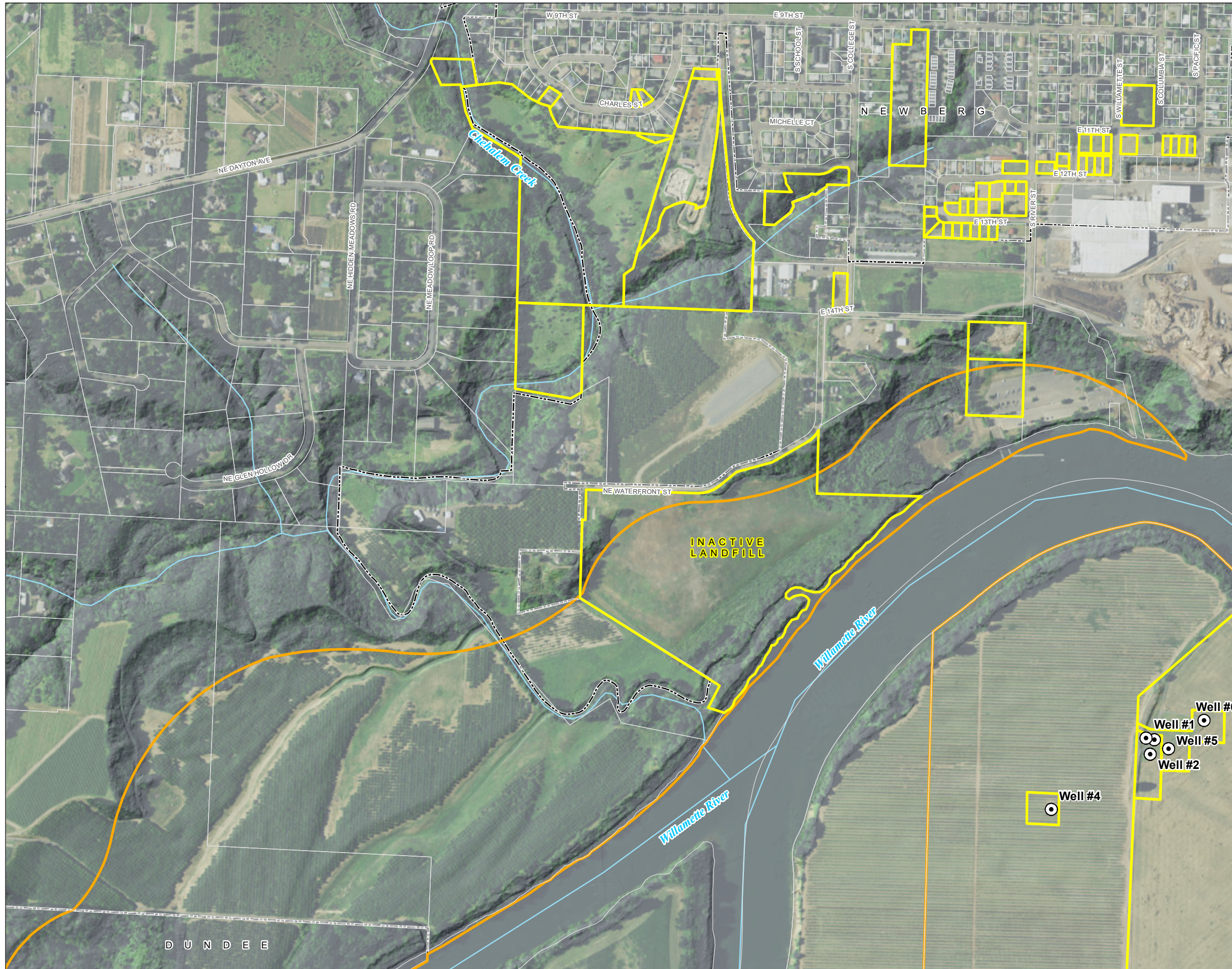


MAP NOTES:

Date: May 31, 2016
 Data Sources: Newberg, Yamhill Co GIS, Marion Co GIS, METRO RLIS, Air photo taken on June 30, 2014 by the USDA

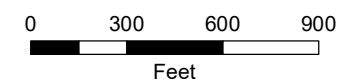


FIGURE 5
Southwest Area
 Expansion Assessment
 Newberg, Oregon



LEGEND

- ⊙ Existing Well
- ▭ Tax Lot Publicly Owned
- ▭ All Other Tax Lots
- ▭ Potential Alluvial Aquifer Source Location
- - - City Limit
- ~ Watercourse



MAP NOTES:

Date: May 31, 2016
 Data Sources: Newberg, Yamhill Co GIS, Marion Co GIS, METRO RLIS, Air photo taken on June 30, 2014 by the USDA





Methodology Report

Water System Development Charges

Prepared For
City of Newberg

February 22, 2017



Introduction

Oregon legislation establishes guidelines for the calculation of system development charges (SDCs). Within these guidelines, local governments have latitude in selecting technical approaches and establishing policies related to the development and administration of SDCs. A discussion of this legislation follows, along with the methodology for calculating updated water SDCs for the City of Newberg (the City) based on the recently completed Water System Master Plan (Murraysmith).

SDC Legislation in Oregon

In the 1989 Oregon state legislative session, a bill was passed that created a uniform framework for the imposition of SDCs statewide. This legislation (Oregon Revised Statute [ORS] 223.297-223.314), which became effective on July 1, 1991, (with subsequent amendments), authorizes local governments to assess SDCs for the following types of capital improvements:

- Drainage and flood control
- Water supply, treatment, and distribution
- Wastewater collection, transmission, treatment, and disposal
- Transportation
- Parks and recreation

The legislation provides guidelines on the calculation and modification of SDCs, accounting requirements to track SDC revenues, and the adoption of administrative review procedures.

SDC Structure

SDCs can be developed around two concepts: (1) a reimbursement fee, and (2) an improvement fee, or a combination of the two. The **reimbursement fee** is based on the costs of capital improvements *already constructed or under construction*. The legislation requires the reimbursement fee to be established or modified by an ordinance or resolution setting forth the methodology used to calculate the charge. This methodology must consider the cost of existing facilities, prior contributions by existing users, gifts or grants from federal or state government or private persons, the value of unused capacity available for future system users, rate-making principles employed to finance the capital improvements, and other relevant factors. The objective of the methodology must be that future system users contribute no more than an equitable share of the capital costs of *existing* facilities. Reimbursement fee revenues are restricted only to capital expenditures for the specific system with which they are assessed, including debt service.

The methodology for establishing or modifying an **improvement fee** must be specified in an ordinance or resolution that demonstrates consideration of the *projected costs of capital improvements identified in an adopted plan and list*, that are needed to increase capacity in the system to meet the demands of new development. Revenues generated through improvement fees are dedicated to capacity-increasing capital improvements or the repayment of

debt on such improvements. An increase in capacity is established if an improvement increases the level of service provided by existing facilities or provides new facilities.

In many systems, growth needs will be met through a combination of existing available capacity and future capacity-enhancing improvements. Therefore, the law provides for a **combined fee** (reimbursement plus improvement component). However, when such a fee is developed, the methodology must demonstrate that the charge is not based on providing the same system capacity.

Credits

The legislation requires that a credit be provided against the improvement fee for the construction of “qualified public improvements.” Qualified public improvements are improvements that are required as a condition of development approval, identified in the system’s capital improvement program, and either (1) not located on or contiguous to the property being developed, or (2) located in whole or in part, on or contiguous to, property that is the subject of development approval and required to be built larger or with greater capacity than is necessary for the particular development project to which the improvement fee is related.

Update and Review

The methodology for establishing or modifying improvement or reimbursement fees shall be available for public inspection. The local government must maintain a list of persons who have made a written request for notification prior to the adoption or amendment of such fees. The legislation includes provisions regarding notification of hearings and filing for reviews. The notification requirements for changes to the fees that represent a modification to the methodology are 90-day written notice prior to first public hearing, with the SDC methodology available for review 60 days prior to public hearing.

Other Provisions

Other provisions of the legislation require:

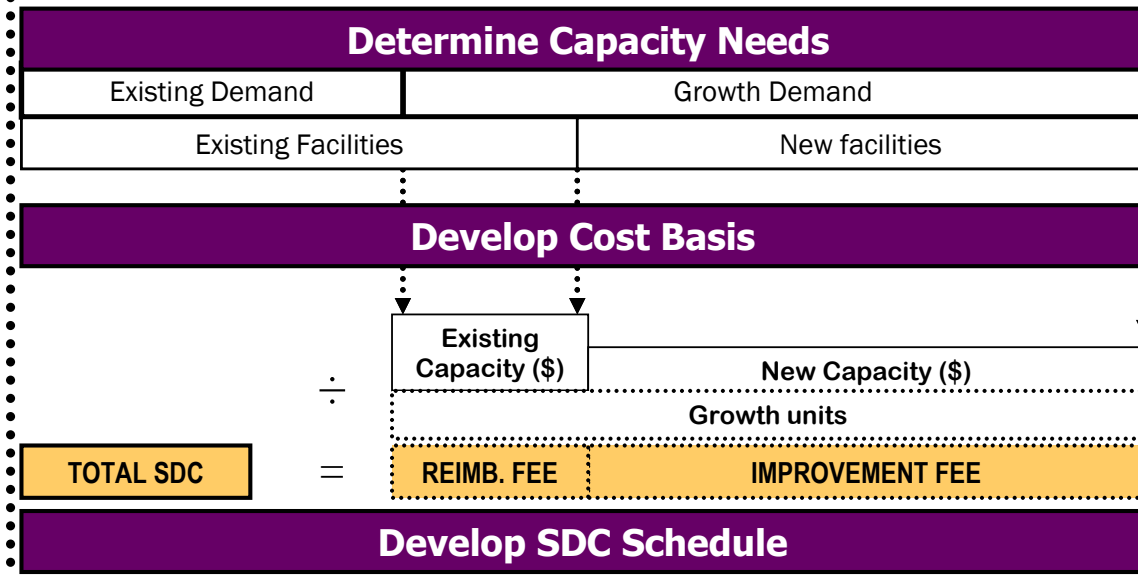
- Preparation of a capital improvement program (CIP) or comparable plan (prior to the establishment of a SDC), that includes a list of the improvements that the jurisdiction intends to fund with improvement fee revenues and the estimated timing, cost, and eligible portion of each improvement.
- Deposit of SDC revenues into dedicated accounts and annual accounting of revenues and expenditures, including a list of the amount spent on each project funded, in whole or in part, by SDC revenues.
- Creation of an administrative appeals procedure, in accordance with the legislation, whereby a citizen or other interested party may challenge an expenditure of SDC revenues.

The provisions of the legislation are invalidated if they are construed to impair the local government’s bond obligations or the ability of the local government to issue new bonds or other financing.

Methodology Overview

The general methodology used to calculate water SDCs in Newberg is illustrated in **Figure 1**. It begins with an analysis of system planning and design criteria to determine growth’s capacity needs, and how they will be met through existing system available capacity and capacity expansion. Then, the capacity to serve growth is valued to determine the “cost basis” for the SDCs, which is then spread over the total growth capacity units to determine the system wide unit costs of capacity. The final step is to determine the SDC schedule, which identifies how different developments will be charged, based on their estimated capacity requirements.

Figure 1 – Overview of SDC Methodology



Water SDC Methodology

This section presents the updated water system development charge (SDC) analysis, based on the City's recently completed Water System Master Plan (Master Plan).

Determine Capacity Needs

Table 1 shows the planning assumptions for the water system as determined by the Master Plan. Capacity requirements are generally evaluated based on the following system design criteria:

- Maximum Day Demand (MDD) -- The highest daily recorded rate of water production in a year. Used for allocating source, pumping and delivery facilities.
- Storage Requirements -- Storage facilities provide three functions: operational (or equalization) storage, and storage for emergency and fire protection needs. Used for allocating storage facility costs.

Table 1
City of Newberg
Water System Development Charge Analysis
Planning Data

	MDD (mgd) ¹	Storage (mg)
Capacity Requirements		
Current		
System	4.90	
Zone 1	4.86	5.87
High Elevation Zones	0.04	0.20
Future Requirements		
System	8.77	
Zone 1	7.35	8.8
High Elevation Zones	1.42	1.7
Growth Allocations		
System Growth	3.87	
<i>Share of Future Requirements</i>	<i>44%</i>	
Zone 1 Growth	2.49	2.93
<i>Share of Future Requirements</i>	<i>34%</i>	<i>33%</i>
High Elevation Growth	1.38	1.5
<i>Share of Future Requirements</i>	<i>97%</i>	<i>88%</i>

¹ Includes potable and non-potable systems

As shown in Table 1, system MDD is currently about 4.9 million gallons per day (mgd), including both potable and non-potable use. Growth in MDD is projected to be about 3.9 mgd over the study period. For supply and delivery purposes, the potable and non-potable

systems are evaluated on a combined basis, as collectively the systems will be used to meet future MDD.

Storage requirements are about 5.6 million gallons (mg) currently, and are limited to the potable system. Future storage requirements are expected to be 8.8 mg in Zone 1, and 1.7 mg in Zone 2. Pumping and storage requirements are evaluated separately for each zone.

Develop Cost Basis

The capacity needed to serve new development will be met through a combination of existing available system capacity and additional capacity from planned system improvements. The reimbursement fee is intended to recover the costs associated with the growth-related capacity in the existing system; the improvement fee is based on the costs of capacity-increasing future improvements needed to meet the demands of growth. The value of capacity needed to serve growth in aggregate within the planning period, adjusted for grants and contributions used to fund facilities, is referred to as the “cost basis”.

Reimbursement Fee

Table 2 shows the reimbursement fee cost basis calculations. The reimbursement fee cost basis reflects the growth share of existing system assets of June 30, 2016. As shown in Table 2, the value of the existing water system (based on original purchase cost) is almost \$44 million. When developer contributions are deducted, the City’s historical investment in water system facilities totals about \$39 million (excluding vehicles and minor equipment costs).

The growth share for each asset type is based on the planning data provided in Table 1. The existing supply, storage, and delivery system facilities all have capacity that will be utilized by future growth, and therefore the allocations are based on growth’s share of future demands. As shown in Table 1, growth share of future MDD (used to allocate supply and delivery costs) is 44 percent, and storage (based on Zone 1 requirements) is 33 percent. Support facilities are allocated 20 percent to future growth, based on the City’s estimates. The reimbursement fee cost basis excludes any assets (like the sodium hypochlorite equipment) that will be replaced by planned capital improvements. As show in Table 2, the reimbursement fee cost basis totals \$16.3 million.

Table 2

City of Newberg
 Water System Development Charge Analysis
 Reimbursement Fee Cost Basis

Description	Original	City	Growth Share	
	Cost	Cost	%	\$
Supply				
Wells	\$3,762,294	\$3,762,294	44%	\$1,660,214
Treatment	\$9,970,901	\$9,970,901	44%	\$4,399,930
Sodium Hypochlorite Equipment	\$167,464	\$167,464	0%	\$0
Springs	\$52,059	\$52,059	44%	\$22,972
Effluent Re-use	\$2,319,652	\$2,319,652	44%	\$1,023,609
Subtotal	\$16,272,370	\$16,272,370		\$7,106,726
Storage				
Corral Creek	\$3,573,002	\$3,573,002	33%	\$1,189,647
North Valley Rd. Reservoir	\$1,939,871	\$1,939,871	33%	\$645,889
Reservoir 1 & 2	\$1,157,019	\$1,157,019	33%	\$385,235
Reservoir 3	\$12,487	\$12,487	33%	\$4,158
East Reservoir	\$320,070	\$320,070	33%	\$106,569
Other	\$43,818	\$43,818	33%	\$14,589
Subtotal	\$7,046,267	\$7,046,267		\$2,346,087
Water Delivery				
Developer	\$4,576,425	\$0	44%	\$0
City Water	\$10,389,944	\$10,389,944	44%	\$4,584,844
Parallel River Line	\$3,191,301	\$3,191,301	44%	\$1,408,248
Water Line N Arterial S Curve	\$1,027,555	\$1,027,555	44%	\$453,436
Effluent Reuse	\$818,636	\$818,636	44%	\$361,245
Subtotal	\$20,003,861	\$15,427,436		\$6,807,774
Support Facilities				
3rd St. Building/Land	\$226,272	\$226,272	20%	\$45,254
2nd St. Parking	\$74,535	\$74,535	20%	\$14,907
Subtotal	\$300,807	\$300,807		\$60,161
Total	\$43,623,305	\$39,046,880		\$16,320,748

Source: City Fixed Asset Records as of June 30, 2016

Improvement Fee

Table 3 shows the improvement fee cost basis calculations. As with the existing facility costs, the costs of most planned improvements (from the Master Plan and the City's capital improvement plan) are allocated in proportion to future demands using the percentages shown in Table 1. Pumping and other high elevation water infrastructure improvements are allocated in proportion to the upper zone needs, and existing distribution main upsizing (which is specific to Zone 1) are allocated in proportion to Zone 1 MDD. System extension at Chehalem Drive and Columbia Drive, and in the nonpotable system is needed only for future growth. Support facilities are allocated 20 percent to growth based on the City's analysis.

As shown in Table 3, the total improvement fee cost basis is about \$15 million.

Table 3
City of Newberg
Water System Development Charge Analysis
Improvement Fee Cost Basis (Project List)

ID#	PROJECT	Time Period	Cost Estimate	SDC-Eligible Portion %	\$
	Supply				
	2 mgd redundant supply development	2019-2023	\$3,619,000	44%	\$1,596,982
	Hypochlorite Generator	2018	\$500,000	44%	\$220,639
	Water Rights Review and Reconfiguration	2018	\$25,000	44%	\$11,032
	Subtotal		\$4,144,000		\$1,828,652
	Pumping				
P-1	Bell East Pump Station - Zone 3	2022-2023	\$1,450,000	97%	\$1,409,155
P-2	Bell West Pump Station - Zone 2	2019-2020	\$1,450,000	97%	\$1,409,155
	Subtotal		\$2,900,000		\$2,818,310
	Distribution				
M-1-M-8, M-18	Upsize existing mains; construct new distribution loops to improve fire flow capacity	2018-2022	\$2,202,000	34%	\$745,984
M-9	NE Zimri Dr Zone 3 distribution backbone within UGB	2023	\$346,000	97%	\$336,254
M-19	Chehalem Dr water system extension west and north to Columbia Dr	2018-2019	\$600,000	100%	\$600,000
M-14 & M-15	N College St - N Terrace Street - Bell West P.S. (P-2) - Veritas School	2019-2020	\$433,000	97%	\$420,803
	College Street WL to Mountain View	2018	\$470,000	10%	\$47,000
	Fixed Base Radio Read	2020	\$1,000,000	44%	\$441,277
	Subtotal		\$5,051,000		\$2,591,317
	Future High Elevation Water Infrastructure				
R-1	1.7 MG Bell Road Reservoir - Zone 3	20 Year +	\$2,400,000	88%	\$2,117,647
M-16	Zimri Dr. E transmission main to Bell Rd Reservoir	20 Year +	\$1,847,000	97%	\$1,794,972
M-17	Bell Rd W transmission main - N College Street to Zimri Dr.	20 Year +	\$1,726,000	97%	\$1,677,380
	Subtotal	\$0	\$5,973,000		\$5,589,999
	Planning				
	Seismic Resilience Study	2018	\$150,000	44%	\$66,192
	Water Management & Conservation Plan	2027	\$100,000	44%	\$44,128
	Water System Master Plan update	2027	\$250,000	44%	\$110,319
	SDC Study	2017	\$5,000	100%	\$5,000
	WTP & Bridge Transmission Main Slope Stability Study	2018	\$150,000	44%	\$66,192
	Subtotal		\$655,000		\$291,830
	Other				
	North non-potable water line and Otis Springs pumping improvements	2024-2027	\$1,750,000	100%	\$1,750,000
	Public Works Maintenance Facility Master Plan	2018-2022	\$737,500	20%	\$147,500
	Subtotal		\$2,487,500		\$1,897,500
	Total		\$21,210,500		\$15,017,608

Develop Unit Costs

The unit costs of capacity are determined by dividing the respective cost bases by the system-wide growth-related capacity requirements defined in Table 1. The system-wide unit costs are then multiplied by the capacity requirements per equivalent dwelling unit (EDU) to yield the fees per EDU. Table 3 shows these calculations.

Table 4
City of Newberg
Water System Development Charge
Unit Cost Calculations

	System Component						Total
	Supply	Storage/ Pumping	Distribution	Upper Elevation	Planning	Support	
Reimbursement Cost Basis	\$7,106,726	\$2,346,087	\$6,807,774	\$0	\$0	\$60,161	\$16,320,748
Growth Capacity Req (mgd)	3.9	3.9	3.9			3.9	
Unit Cost	\$1,836,363	\$606,224	\$1,759,115			\$15,546	
Capacity per EDU (mgd)	0.000605	0.000605	0.000605			0.000605	
Reimbursement \$/EDU	\$1,110	\$367	\$1,064	\$0	\$0	\$9	\$2,550
Improvement Cost Basis	\$1,828,652	\$2,818,310	\$4,341,317	\$5,589,999	\$291,830	\$147,500	\$15,017,608
Growth Capacity Req (mgd)	3.9	3.9	3.9	3.9	3.9	3.9	
Unit Cost	\$472,520	\$728,245	\$1,121,787	\$1,444,444	\$75,408	\$38,114	
Capacity per EDU (mgd)	0.000605	0.000605	0.000605	0.000605	0.000605	0.000605	
Improvement \$/EDU	\$286	\$440	\$678	\$873	\$46	\$23	\$2,346

EDU capacity requirements are estimated based on current MDD and the total number of meter equivalents in the system. The base service unit for the water system is a 3/4-inch meter, the standard size for a single family dwelling. The meter equivalents for larger meter sizes represent the equivalent hydraulic capacity relative to a 3/4-inch meter. **Table 5** shows the meter equivalency factors for each meter size.

Based on the existing MDD and meter equivalents, the estimated capacity requirement per EDU is 605 gallons per day (0.000605 mgd). Applying the capacity requirement per EDU by the unit costs of capacity yields reimbursement and improvement costs per EDU of \$2,550 and \$2,346, respectively as shown in Table 4.

SDC Schedule

Table 5 shows the SDC schedule for each meter size for potable and non-potable customers. The potable SDCs include the full cost per EDU shown in Table 4, while the non-potable SDCs exclude the costs of storage and upper elevation pumping and other improvements. The total SDC per EDU for potable and non-potable are \$4,896 and \$3,216, respectively. The SDCs for larger meter sizes are scaled up based on the hydraulic capacity factors.

Table 5
City of Newberg
Water System Development Charge Analysis
SDC Schedule

Meter Size	SDCr	SDCi	Potable SDC	Factor 3/4"
Potable				
3/4"	\$2,550	\$2,346	\$4,896	1.0
1"	\$4,335	\$3,989	\$8,323	1.7
1 1/4"	\$6,375	\$5,866	\$12,240	2.5
1 1/2"	\$8,415	\$7,743	\$16,157	3.3
2"	\$13,514	\$12,435	\$25,949	5.3
3"	\$25,499	\$23,463	\$48,961	10.0
4"	\$42,583	\$39,183	\$81,765	16.7
6"	\$84,145	\$77,427	\$161,572	33.0
8"	\$135,142	\$124,352	\$259,494	53.0
10"	\$195,489	\$179,880	\$375,368	76.7
NonPotable				
3/4"	\$2,183	\$1,033	\$3,216	1.0
1"	\$3,712	\$1,755	\$5,467	1.7
1 1/4"	\$5,458	\$2,581	\$8,040	2.5
1 1/2"	\$7,205	\$3,408	\$10,613	3.3
2"	\$11,572	\$5,473	\$17,044	5.3
3"	\$21,833	\$10,326	\$32,159	10.0
4"	\$36,461	\$17,244	\$53,706	16.7
6"	\$72,049	\$34,076	\$106,125	33.0
8"	\$115,716	\$54,728	\$170,443	53.0
10"	\$167,387	\$79,166	\$246,553	76.7



APPENDIX E

Addendum Riverfront Master Plan (Adopted 5/3/21)

Technical Memorandum

Date: May 2021

Project: Water Master Plan Technical Update

To: Mr. Brett Musick, PE
City of Newberg

From: Heidi Springer, PE
Murraysmith

Re: Technical Update Addendum – Riverfront water demand, performance criteria review, distribution system analysis, IBTER analysis

Introduction and Purpose

The Newberg City Council accepted the 2019 Riverfront Master Plan (RMP) on September 16, 2019. The purpose of this Water Master Plan (WMP) Technical Update Addendum is to build on and refine the proposed water infrastructure identified in the RMP. The RMP identified various infrastructure improvements necessary to support the overall vision of the Riverfront area and the development and redevelopment opportunities.

Although refining the recommended Riverfront area infrastructure was the initial goal for this WMP Technical Update, the City also identified other water system analyses and recommended improvements since 2017 which are included in this update.

The 2020 Technical Update of the City of Newberg's (City's) 2017 Water Master Plan (WMP) focused on three key areas:

1. **Riverfront** - update the 2017 WMP analysis and capital improvement program (CIP) to include the Riverfront Master Plan (RMP) area
2. **Seismic resilience** – update the 2017 WMP CIP to include recommended improvements from the City's Seismic Resilience Assessment (SRA) (HDR, 2020)
3. **IBTER** – evaluate the water system impact, if any, of potential increased density in two areas near downtown Newberg to support an Infrastructure Based Time Extension Request (IBTER) under Oregon House Bill 2001 Middle Housing implementation rules

Each of these analyses resulted in recommended changes to the City's water system CIP. This memo documents the analyses, results, and recommendations including key assumptions. This technical memorandum is not intended to meet all State requirements for a WMP update it is rather to provide supporting analysis for an amendment to the 2017 WMP. The goal of this technical update is to assist the City in planning for adequate water infrastructure to serve new development areas that were not included in the 2017 WMP and incorporate seismic resilience recommendations in the City's long-term water system planning.

Background

Riverfront

In 2019 the City accepted the Riverfront Master Plan (RMP), a re-development concept plan for a 450-acre area adjacent to the Willamette River at the southern end of Newberg's water service area. The RMP area includes the former WestRock mill site which was permanently closed in 2016 while the 2017 WMP project was in progress. At that time, the mill site and portions of the surrounding RMP area were outside of the City's water service area.

The RMP includes proposed land use for the Riverfront area which is used in this technical update to estimate future water demand for the Riverfront. The RMP also includes high-level water system improvement recommendations to serve proposed land uses and potential development in the Riverfront area. This technical update implements the RMP recommendations by conducting analysis to refine the recommended infrastructure, such as, recommended water main size and incorporating this recommended infrastructure into the City's existing WMP CIP.

Seismic Resilience

In accordance with utility planning guidelines in the Oregon Resilience Plan the City conducted a water system Seismic Resilience Assessment (HDR, 2020) to identify geohazards associated with a Cascadia Subduction Zone (CSZ) earthquake and possible impacts to vulnerable water system facilities from the CSZ. This technical update, included as **Appendix B**, incorporates recommended capital improvements and recommendations for further evaluation of specific facilities from the City's SRA. This WMP technical update does not include any additional assessment of seismic geohazards or potential water facility vulnerabilities to seismic hazards.

IBTER

This technical update includes recommended capital improvements identified as part of the IBTER analysis. The details of the IBTER analysis are documented in a separate technical memorandum included as **Appendix A**. The IBTER analysis is an estimate of the impact of increased residential housing density on water system infrastructure in two areas of the City of Newberg. Increased housing density is anticipated as a result of 2019 Oregon legislation, House Bill (HB) 2001 Missing Middle Housing, which requires updates to local laws throughout Oregon that currently limit the types of housing approved for construction in residentially zoned areas.

The City will adopt regulations that will allow for the development of duplexes and other types of middle housing in areas zoned for residential development to comply with this legislation and address needed housing types for residents at all income levels.

The IBTER analysis documented in **Appendix A** was conducted to inform an Infrastructure-Based Time Extension Request (IBTER) as described in Oregon Administrative Rules (OARs) 660-046-0300 to 0370 which became effective August 7, 2020. An approved IBTER would grant the City additional time to comply with the requirements of HB 2001 Middle Housing.

IBTER Study Areas

City staff identified two areas for infrastructure analysis to inform an IBTER:

- North of Downtown Newberg - up to the rail line that runs through Newberg to Hess Creek (**Appendix A, Figure 1**)
- South of Downtown Newberg - from the Chehalem Creek and railroad line intersection to the WestRock line and Hess Creek (**Appendix A, Figure 2**)

2017 WMP References

The City will complete an addendum to the 2017 WMP utilizing this Technical Update. To support this addendum, sections of the 2017 WMP which are impacted by analyses documented in this report are indicated in brackets throughout the text. Example: [Sect. 2, page 2-1]. Changes are summarized in **Table 9** at the end of this memo.

Water Demand Update

Water demand refers to all potable water required by the system including residential, commercial, industrial, and institutional uses. Potable water demands are described using three water use metrics, each stated in gallons per unit of time, such as, million gallons per day (mgd):

- average daily demand (ADD) - the total annual water volume used system-wide divided by 365 days per year
- maximum day demand (MDD) - the largest 24-hour water volume for a given year, occurs each year between July 1st and September 30th, historically about 2 times ADD in Newberg
- peak hour demand (PHD) - the largest hour of demand on the maximum water use day, estimated as 1.7 times MDD

Water demand can be calculated using either water consumption or water production data. Water consumption data is taken from the City's customer billing records and includes all revenue metered uses. Water production is measured as the water supplied to the distribution system from the City's Water Treatment Plant (WTP) plus the water volume supplied from distribution

storage. Water production includes unaccounted-for water like water loss through minor leaks and unmetered, non-revenue uses, such as, hydrant flushing. For the purposes of this analysis, water production data is used to estimate current water demand.

Current Demand

Table 1 summarizes the City’s current and historical system-wide water demand based on water production data from the WTP. [Table 2-1, page 2-3] As shown in **Table 1** Newberg’s system-wide demand has remained steady over the last 10 years. In general, the City’s per person water demand is declining with ADD growing approximately 7 percent and population growing 10 percent over the same period. Per person water demand is measured in gallons per capita per day (gpcd) and is used to correlate water demand with population for estimating future water demand.

Table 1
Current and Historical Water Demand

Year	Population	ADD		MDD	
		(mgd)	(gpcd)	(mgd)	(gpcd)
2010	22,110	2.23	101	4.84	219
2011	22,230	2.24	101	4.42	199
2012	22,300	2.27	102	4.76	213
2013	22,580	2.24	99	4.39	194
2014	22,765	2.31	101	4.43	194
2015	22,900	2.38	104	4.75	207
2016	23,465	2.34	100	Data not requested	
2017	23,480	2.35	100	Data not requested	
2018	23,795	2.39	100	4.72	198
2019	24,045	2.27	94	4.16	173
2020	24,120	2.34	97	4.60	191

1. Population estimates are from Portland State University Population Research Center (PSU PRC) 2019 annual report.

Estimated Future Demand

The 2017 WMP included estimated future water demand in 2035 based on anticipated population growth. Due to slower than anticipated growth since 2017, it is assumed that the 2035 water demand projection from the 2017 WMP is an adequate estimate of projected 20-year demand in 2041 within the current water service area.

Riverfront

The Riverfront area was outside of the anticipated future water service area in the 2017 WMP, thus projected demand for this area must be added to projected 20-year demands from the 2017 WMP. Potential development in the Riverfront area is estimated based on anticipated land use described in the RMP Appendix C Preferred Alternative E. Future water demand is estimated by applying an average water use per acre (non-residential) or per unit (residential) based on 2019 City water billing records. **Figure 1** illustrates estimated water demand. **Table 2** summarizes projected 20-year water demand [Table 2-3, page 2-5] including the Riverfront area.

Projected demands presented in **Table 2** assume that all future Riverfront demand will be served from Pressure Zone 1 [Table 2-4, page 2-6], the Riverfront area will reach saturation development or build-out within 20 years (by 2041), and water use characteristics will resemble those of existing Newberg water customers. Projected demands do not explicitly include high water use industries, such as, food processing or semi-conductor manufacturing.

Table 2
Projected 20-year Water Demand

20-year Demand (mgd)	ADD	MDD	PHD
2035 Demand from 2017 WMP	3.89	7.78	13.23
Riverfront demand	0.17	0.34	0.58
2041 Projected Demand	4.06	8.12	13.80

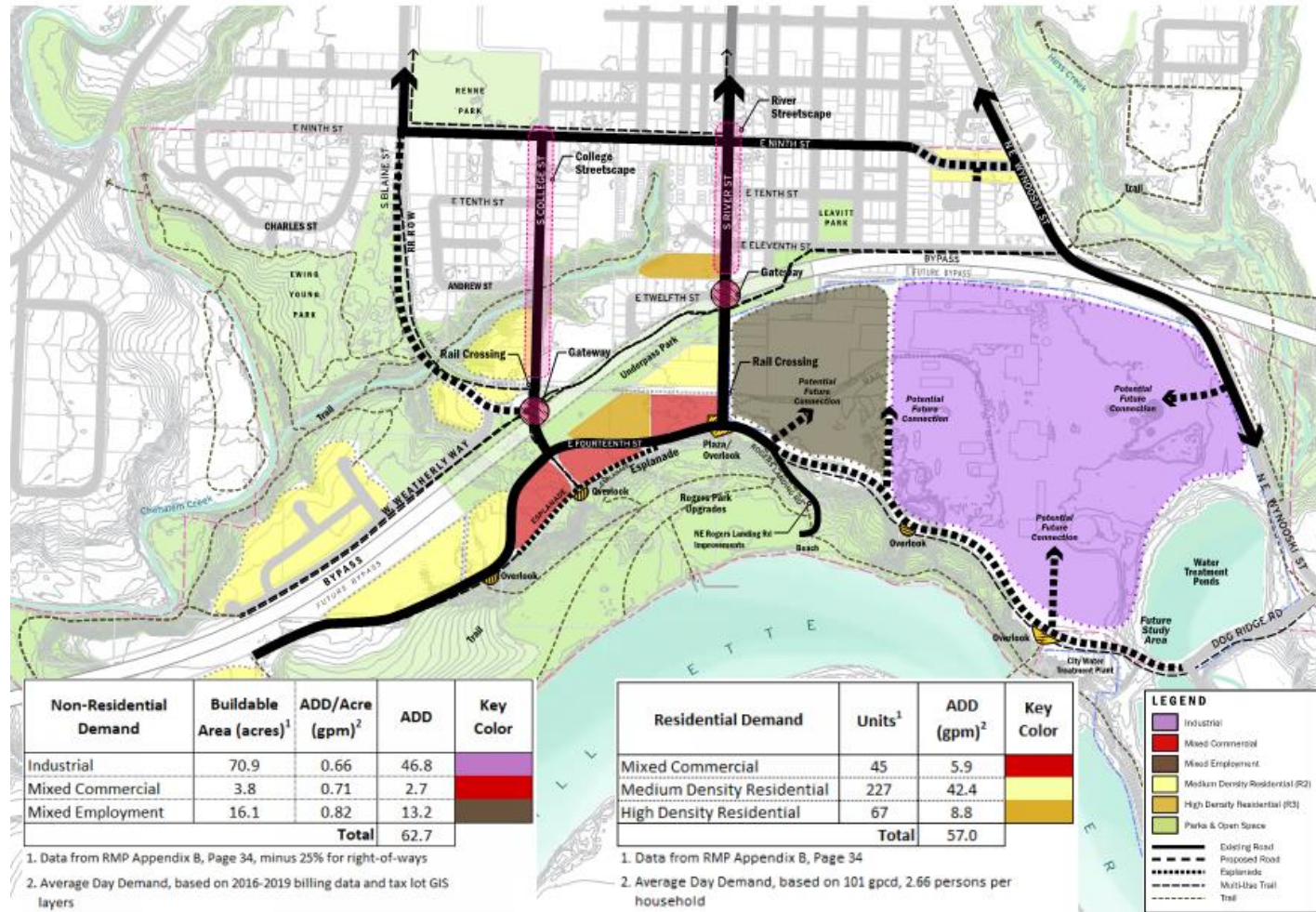
Future Demand by Zone

As stated above, all future Riverfront water demand is anticipated to be served from Zone 1. Existing demand in Zone 2 is assumed to be approximately the same as existing Zone 2 presented in the 2017 WMP. Future Zone 2 and 3 water demands projected in the 2017 WMP to occur in 2035 are assumed to occur by 2041. Future water demands for Zones 2, 3, and 4 projected to occur beyond the 20-year planning horizon in the 2017 WMP, remain beyond the new 20-year planning horizon (2041) for this analysis. Existing, projected 20-year, and build-out demand is summarized in **Table 3** [Table 2-4, page 2-6]

Table 3
Projected Future Demand by Zone

Zone	Current (mgd)		2041 (mgd)		Build-out (mgd)	
	ADD	MDD	ADD	MDD	ADD	MDD
1	2.31	2.23	3.76	7.52	3.79	7.58
2	0.02	2.24	0.27	0.54	0.27	0.54
3	-	-	0.03	0.06	0.33	0.66
4	-	-	-	-	0.11	0.22
TOTAL	2.33	4.47	4.06	8.12	4.50	9.00

Figure 1
 Estimated Water Demand – Future Riverfront Development



1. Basemapping and proposed zoning in Figure 1 taken from RMP Appendix C Preferred Alternative E.

Performance Criteria Review

Performance criteria defines water system operating standards, such as, service pressure and required supply or storage capacity. These criteria are used to evaluate the existing water supply and distribution system under existing and projected future water demand conditions. Criteria is also used to size proposed facilities to serve future growth or mitigate deficiencies in the existing water infrastructure. **Table 4** summarizes performance criteria from the 2017 WMP and proposed criteria for this WMP Technical Update [Sect. 3, Summary, page 3-8]. No changes were recommended to 2017 WMP performance criteria. Criteria was selected for required fire flow in unique Riverfront zoning designations.

Based on 2019 Oregon Fire Code (OFC) revisions, the City could elect less conservative required fire flow criteria for industrial, institutional, and hospitality zoned areas. The 2019 OFC Appendix B.105 sets a maximum required fire flow from any public water system at 3,000 gallons per minute (gpm) in areas with adequate and reliable water systems such as the City of Newberg. This 3,000 gpm requirement is less than the 4,500 gpm for this zoning documented in the 2017 WMP. Maintaining the more conservative fire flow criteria for these zoning designations did not increase the number of fire flow related CIP projects within the water service area.

Table 4
Performance Criteria Comparison Summary

Water System Component	Evaluation Criterion	2017 WMP Value	2020 WMP Update Value	Design Standard/Guideline and Comments on Differences
Water Supply	MDD Supply under Firm Capacity Conditions	Largest well out of service; 1 transmission main out of service; One treatment train out of service; Largest high-service pump out of service	No change	Washington Water System Design Manual
	Normal Range, during ADD	40-80 psi	No change	City's 2015 Public Works <i>Design and Construciton Standards</i> , Oregon Plumbing Specialty Code
Service Pressure	Maximum, without PRV	80 psi	No change	Oregon Plumbing Specialty Code 608.2
	Minimum, during emergency or fire flow	20 psi	No change	OAR 333-061
	Minimum, during PHD ²	75% of normal, not less than 30 psi	No change	Murraysmith recommended
	Velocity during PHD or fire flow	Not to exceed 8 fps	No change	City's 2015 Public Works <i>Design and Construciton Standards</i>
Velocity during ADD	Not to exceed 5 fps	No change		
Minimum Pipe Diameter	8-inch minimum for new, permanently dead-ended residential water mains and primary feeder mains in residential areas	No change		
Storage	Operational Storage	PHD for 2.5 hours with non-emergency pumps serving at full capacity	No change	Washington State Department of Health's <i>Water System Design Manual</i>
	Fire Storage	Flow times duration of most severe fire demand within each zone	No change	2019 Oregon Fire Code B106
	Emergency Storage	100% of MDD	No change	Murraysmith recommended (City has a single supply source)

Table 4
Performance Criteria Comparison Summary (continued)

Water System Component	Evaluation Criterion	2017 WMP Value	2020 WMP Update Value	Design Standard/Guideline and Comments on Differences
Required Fire Flow and Duration	Low Density - Single Family and Duplex Residential <= 3,600 sq ft	1,000 gpm for 2 hours	No change	2014 Oregon Fire Code vs. 2019 Oregon Fire Code Appendix B, Insurance Services Office (ISO) Supply Gradings for Public Protection Classification (PPC)
	Single Family and Duplex Residential >3,600 sq ft	1,500 gpm for 2 hours	Possible increase, not selected 1,750 gpm for 2 hours	
	Medium Density Residential	1,500 gpm for 2 hours	Possible increase, not selected 2,000 gpm for 2 hours	
	High Density Residential	2,000 gpm for 3 hours	Possible increase, not selected 3,000 gpm for 3 hours	
	Commerical	3,000 gpm for 3 hours	No change	
	Industrial, Institutional, and Hospitality	4,500 gpm for 3 hours	Possible decrease, not selected 3,000 gpm for 3 hours	
	Mixed Commercial (RMP)	-	2,000 gpm for 3 hours	
	Mixed Employment (RMP)	-	3,000 gpm for 3 hours	

Distribution System Analysis

The distribution system analysis is an evaluation of existing supply, finished water storage, and pumping facilities as well as distribution mains to determine if adequate capacity is available to meet the criteria defined in **Table 4** through the 20-year planning period. As previously described, projected 20-year (2041) water demands within the current water service area remain the same for this analysis as those projected in the 2017 WMP to occur in 2035. The new Riverfront area adds approximately 4 percent to the projected 20-year Zone 1 ADD for this WMP Technical Update. This minor increase in projected demand will not impact the City's Zone 1 storage or Zone 1 pumping capacity which is adequately sized for projected 20-year demands as concluded in the 2017 WMP [Sect 5, Tables 5-1 and 5-2]. Facilities recommended in the 2017 WMP to serve future growth in higher elevation Zones 2 and 3, such as the Bell Road Reservoir, are not impacted by this future Riverfront demand.

Supply

Capacity criteria documented in **Table 4** states that supply capacity must be equal to MDD. As shown in **Table 2**, projected 20-year MDD with the Riverfront area exceeds the current 8 mgd capacity of the City's WTP by 0.12 mgd. Although this indicates a supply deficiency in 20 years [Sect. 4, page 4-8], for a deficiency this small, approximately 1.5 percent of demand, it is recommended that the City manage this deficit through operational strategy rather than investing capital in constructing additional storage. This would mean using more depth in the City's existing Zone 1 storage reservoirs, North Valley and Corral Creek, to meet the small amount of demand that exceeds supply from the WTP on the 2 to 3 days of each year that system demand is expected to be over 8 mgd.

When considering an operational approach to offsetting projected future deficiencies it is also important to recognize the degrees of uncertainty involved in projecting future water demand. Planning for future water demand growth involves uncertainty in population and economic growth rates as well as customer water use volumes, conservation, and potential impacts from climate change. As growth continues in the City, projected growth rates and customer water use characteristics can be revised to represent trends more accurately at the time. As these projected demand revisions are completed, this operational strategy recommendation to address supply deficiencies should be revisited.

Distribution Mains

For the current analysis, distribution mains were evaluated using a hydraulic network analysis model developed and calibrated for the 2017 WMP. Capacity deficiencies and recommended improvements were the same as those identified in the 2017 WMP except for the Riverfront and IBTER areas. These results are as expected given the localized change in 20-year projected demand from the anticipated Riverfront development and increased fire flow requirements because of changes in zoning to accommodate future middle housing in the IBTER analysis areas. Analysis results and recommended improvements are documented in the following paragraphs. Proposed

Riverfront and IBTER piping improvement CIP projects are illustrated on **Figure 2** at the end of this memo and summarized in **Tables 5** and **6**.

Future Riverfront Distribution Mains

Distribution main alignments to serve future Riverfront development are based on proposed roadway alignments from the RMP and preliminary site plans from the Riverrun development on the north side of W Weatherly Way. Riverfront distribution mains are sized based on the projected 20-year demands summarized in **Table 2** and required fire flow based on proposed zoning from the RMP Appendix C Preferred Alternative E zoning as presented in **Table 4** and **Figure 1**.

Table 5
Proposed Riverfront Improvements

Project No.	Project Description	Estimated Cost
RMP-1	Install 2,398 LF of 12-inch DI Pipe in Wynooski Street	\$ 1,080,000
RMP-2	Install 2,447 LF of 12-inch DI Pipe in new Riverfront road between S River Street and City WTP	\$ 1,102,000
RMP-3	Install 1,422 LF of 8-inch DI Pipe in NE Waterfront Street from S College Street west to (future) crossing to S Gia Court	\$ 512,000
RMP-4	Install 1,163 LF of 8-inch DI Pipe in NE Waterfront Street from (future) S Gia Ct crossing west to loop under bypass to W Weatherly Way	\$ 419,000
RMP-5	Install 834 LF of 8-inch DI Pipe in S College Street between E 10th and E 13th Streets	\$ 301,000
RMP-6	Install 812 LF of 12-inch DI Pipe in S River Street between E 12th and E 14th Streets	\$ 366,000
RMP-7	Install 521 LF of 12-inch DI Pipe in E 11th Street between S River and S Willamette Streets	\$ 235,000
RMP-8	Install 1,001 LF of 12-inch DI Pipe in E 14th Street between S College Street and S River Street	\$ 451,000
RMP-9	Install 271 LF of 8-inch DI Pipe in S College Street between W Weatherly Way and E 14th/NE Waterfront Street	\$ 98,000
TOTAL COST		\$ 4,564,000

1. All costs in 2020 dollars.
2. Includes: costs for fittings/valves and connections to existing services and hydrants; local street trench patch resurfacing; an allowance of 30% for construction contingency, 25% for engineering, permitting and inspection, and 1% for Oregon Corporate Activity Tax (applied to construction costs only)
3. Not included: whole or half street overlay cost; easement or property acquisition costs; City project management and administrative costs

IBTER Analysis

Consistent with IBTER state guidelines, local fire flow availability and service pressure resulting from potential increased density within the IBTER study areas were evaluated. The full IBTER analysis report is available in **Appendix A**. IBTER guidelines limit estimated housing unit growth due to HB 2001 to less than 3 percent. Increased water demand for such a small percent of residential growth has no impact on water system operating pressure.

Fire Flow Availability

Fire flow availability was tested at 2,000 gpm in the IBTER study areas consistent with high density residential required fire flow from **Table 4**. This 2,000 gpm fire flow may be conservative in some parts of the IBTER study areas where smaller structures with fewer units, like duplexes, are more likely to be developed. However, providing water infrastructure capable of supplying a 2,000 gpm fire flow allows the City to consider a broader range of middle housing options as HB 2001 zoning changes are evaluated.

Fire flow availability in the south IBTER study area is constrained by high pipe flow velocity. Adequate pressure is available to supply fire flow and maintain service pressures above 20 psi for public health. However, small diameter 4- and 6-inch pipe grids in the south study area create flow velocities over 20 feet per second (fps) during a fire flow event. Fire flow in the north study area is less constrained with 8-inch diameter well looped existing mains interconnected with the 18-inch diameter North Valley Reservoirs transmission main.

The primary concern with high pipe velocity is abrasion of the interior pipe coating, which can expose the pipe material to corrosion and lead to potential pipe failure. This is generally a greater concern when high flow velocity extends over a long period of time as part of normal system operation. In the case of a fire flow event, these high flow velocities are both infrequent and for a short time when they do occur. Thus, a pipe velocity higher than the 8 fps specified in **Table 4** may be acceptable, provided there is adequate available pressure to supply fire flow as is the case in Newberg's IBTER south study area. For the purposes of this analysis available fire flow in IBTER study areas is evaluated at a flow velocity of 14 fps.

Recommended Middle Housing (IBTER) Pipe Improvements

Eight significant pipe improvement projects are recommended for the south study area and one minor project is recommended for the north study area to provide adequate fire flows to potential higher density development. In the south, existing development is primarily served from a 4- and 6-inch diameter pipe grid. While a 6-inch diameter main can provide a 1,000 gpm single-family residential fire flow, a 6-inch diameter grid does not have adequate capacity to provide a 2,000 gpm multi-family residential fire flow.

Existing 6-inch diameter mains along key corridors in the south study area, including S College Street, S River Street, and E 9th Street, are recommended to be upsized to 12-inch diameter mains to provide a large diameter backbone for the area to meet 2,000 gpm fire flow requirements for

potential higher density development. Additional looping is also recommended to connect larger diameter mains with the 18-inch diameter transmission main in Wynooski Street and for the W 4th Street neighborhood between Dayton Avenue and Hwy 99W.

Two areas in the southwest corner of the south study area cannot be supplied a 2,000 gpm fire flow without significant or total pipe replacement and upsizing. The first area is the S Charles Street loop, which is bordered by Chehalem Creek to the west making it difficult to loop with the water system outside of the south study area. The second area is between S College Street and S River Street just north of the Newberg Dundee Bypass, which does not have an existing east-west right-of-way to provide additional looping. Rather than replacing these pipes in their current alignments, it is instead recommended that the City assess fire flow to these areas and potential distribution system looping along with future transportation projects associated with the Riverfront area, such as the extension of S Blaine Street south of Ewing Young Park and the extension of a future road across the former WestRock mill property connecting the area around the City’s WTP and NE Rogers Landing Road.

Table 6
Proposed IBTER Improvements

Project No.	Project Description	Estimated Cost
I-1	Install 1,733 LF of 8-inch DI Pipe in S Main Street, W 4th Street, S Lincoln Street, and W 5th Street	\$ 624,000
I-2	Install 2,558 LF of 12-inch DI Pipe in S Blaine Street	\$ 1,152,000
I-3a	Install 28 LF of 8-inch DI Pipe in S College Street north of E 9th Street	\$ 11,000
I-3b	Install 2,934 LF of 12-inch DI Pipe in E 9th Street, Charles Street, and S College Street	\$ 1,321,000
I-4a	Install 42 LF of 8-inch DI Pipe in S Meridian Street north of E 5th Street	\$ 16,000
I-4b	Install 730 LF of 12-inch DI Pipe in S Meridian Street	\$ 329,000
I-5	Install 3,691 LF of 12-inch DI Pipe in E 7th Street, S Pacific Street, E 9th Street, and Paradise Drive	\$ 1,662,000
I-6	Install 2,736 LF of 12-inch DI Pipe in S River Street (north of the by-pass)	\$ 1,232,000
I-7	Install 453 LF of 12-inch DI Pipe in E 5th Street	\$ 204,000
I-8	Install 159 LF of 8-inch DI Pipe from E 11th Street to the Boston Square Apartments	\$ 58,000
I-9	Install 15 LF of 8-inch DI Pipe in Vermillion Street	\$ 6,000
Total Cost		6,615,000

1. All costs in 2020 dollars.
2. Includes: costs for fittings/valves and connections to existing services and hydrants; local street trench patch resurfacing; an allowance of 30% for construction contingency, 25% for engineering, permitting and inspection, and 1% for Oregon Corporate Activity Tax (applied to construction costs only)
3. Not included: whole or half street overlay cost; easement or property acquisition costs; City project management and administrative costs

Seismic Resilience

As of 2018, OARs governing WMPs require that water providers address seismic resilience in their WMPs. The City conducted a water system Seismic Resilience Assessment (SRA) in 2020 (HDR, 2020). The purpose of the SRA is to define seismic recovery goals for the City system, evaluate the expected performance of the water system during a CSZ earthquake, and identify recommended mitigation measures to address deficiencies.

Geohazards and System Vulnerability

The SRA included a review of the existing geologic and geotechnical conditions in Newberg's water service area to develop seismic ground motion, seismic hazard, and permanent ground deformation hazard maps. Water system components were compared against these seismic hazard maps showing peak ground velocity, probability of liquefaction, and landslide induced permanent ground deformation.

Based on the SRA, vulnerabilities were identified in the raw water pipeline bridge, the 30-inch raw water transmission main, the wellfield, and the WTP due to lateral spreading and soil liquefaction. In general, the SRA review of the WTP structures indicated that none meet either the structural or non-structural performance objectives outlined as part of the seismic recovery goals. The SRA noted that while the buildings will not withstand a CSZ event, the WTP site itself is not susceptible to a landslide into the adjacent Willamette River. The SRA states significant work is required at the WTP to meet recovery goals, and further evaluation is recommended to compare the cost of upgrading the WTP with building a new WTP. Follow-on analysis conducted after the SRA indicates retrofitting the WTP is the more cost-effective option for addressing these seismic vulnerabilities as presented in the seismic improvements **Table 7**.

The water distribution network is considered a lower priority for seismic resilience based on the seismic recovery goals established by the City in the SRA. Improvements are recommended in the SRA at system finished water reservoirs at the North Valley site to address hydraulic control and yard piping seismic vulnerabilities. Distribution backbone piping is also recommended for replacement with more seismically resilient materials.

Recommended Seismic Mitigation Projects

Table 7 summarizes projects recommended in the SRA to mitigate seismic vulnerabilities in the City's water facilities and water distribution backbone piping. The SRA provided a range of costs for mitigation projects as well as recommendations for additional studies needed to assess specific facilities. City staff provided final cost estimates for these projects to be included in the CIP.

Table 7
Proposed Seismic Resilience Improvements

Project	Description	Estimated Cost
Existing WTP Seismic Retrofit	Install ground improvements between WTP site and the Willamette shoreline to prevent lateral movement, strengthen structural components to withstand a CSZ	\$ 8,500,000
Emergency Connection and Controls at the WTP	Add an emergency cross-connection and hydraulic control valves to isolate the WTP during an earthquake	\$ 500,000
Improvements to North Valley Reservoirs	Add hydraulic control valves and replace a portion of the pipe at North Valley Water Storage Tanks	\$ 1,050,000
Cast Iron and Concrete Pipe Replacement - 20 year total	Replacement of more than 37,000 linear feet of old cast iron and concrete pipe	\$ 1,500,000
Seismic Resilience Planning and Studies		
	Develop new engineering standards	\$ 50,000
	Additional geotechnical investigations to define geohazards	\$ 75,000
	Investigate specific structural recommendations at existing WTP and other City facilities	\$ 100,000
	Evaluate mitigation strategies for raw water pipeline bridge	\$ 75,000
Total Cost		\$ 11,850,000

Capital Improvement Program Update

The 2017 WMP CIP project list [Table 7-5, page 7-15] was updated by:

- Removing completed projects
- Revising costs for projects with more refined City budgeted costs and adjusting for regional construction cost changes since 2017
- Adding proposed CIP projects for Riverfront, IBTER/middle housing areas, and seismic resilience as presented in **Tables 5, 6, and 7**

The proposed CIP for this WMP Technical Update is presented in **Table 8**.

Cost Estimates

An estimated cost has been developed for each recommended improvement project. For Riverfront and IBTER projects, new piping is assumed to be ductile iron pipe installed by private contractors. Seismic resilience improvement costs were taken from the SRA and refined as needed by City staff.

Cost estimates represent opinions of cost only, acknowledging that final costs of individual projects will vary depending on actual labor and material costs, market conditions for construction, regulatory factors, final project scope, project schedule and other factors. The Association for the Advancement of Cost Engineering International (ACE) classifies cost estimates depending on project definition, end usage, and other factors. The cost estimates presented here are considered Class 4 with an end use being a study or feasibility evaluation and an expected accuracy range of -30 percent to +50 percent. As the project is better defined, the accuracy level of the estimates can be narrowed.

Since construction costs change periodically, an indexing method to adjust present estimates in the future is useful. The Engineering News-Record (ENR) Construction Cost Index (CCI) is a commonly used index for this purpose. For purposes of future cost estimate updating, the ENR CCI for Seattle, Washington for these estimates is 12,771.70 (September 2020).

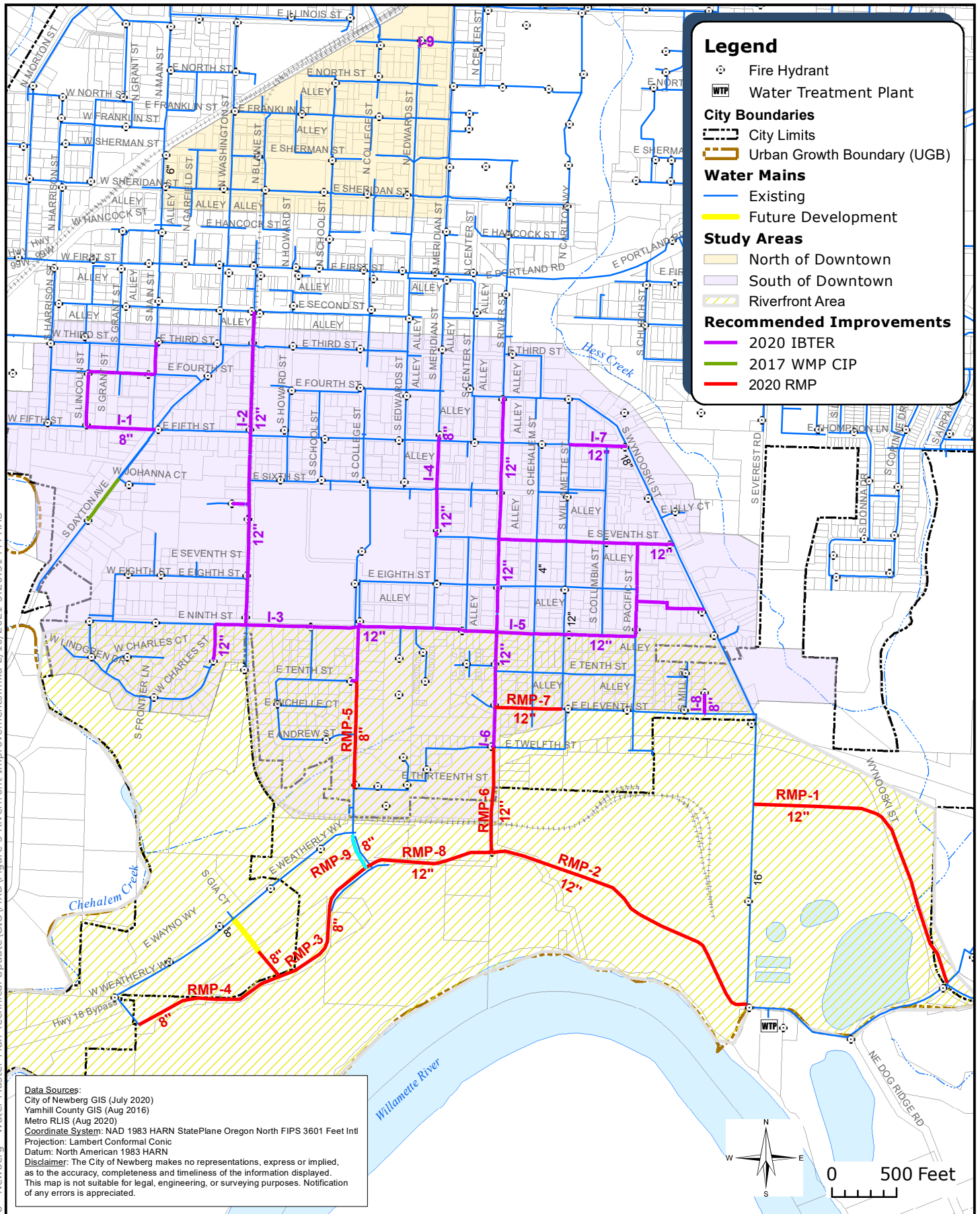
Table 8

Capital Improvement Program (CIP)

Improvement Category	Project No.	Project Title	CIP Cost Summary ¹				Purpose	
			5-year 2021 to 2026	5 to 10-year 2027 to 2031	10 to 20-year 2032 to 2041	20-year TOTAL		
Supply		2 mgd redundant supply development	\$ 3,915,000			\$ 3,915,000	Resilience	
		Seismic resilience - add emergency connection and controls at existing WTP	\$ 500,000			\$ 500,000	Resilience	
		Seismic resilience - existing WTP seismic upgrade		\$ 8,500,000		\$ 8,500,000	Resilience, replacement of existing, not SDC eligible	
<i>Supply Subtotal</i>			\$ 4,415,000	\$ 8,500,000	\$ -	\$ 12,915,000		
Storage Reservoirs		Seismic resilience - North Valley Reservoirs hydraulic control valves and site piping improvements		\$ 1,050,000		\$ 1,050,000	Resilience, replacement of existing, not SDC eligible	
<i>Storage Subtotal</i>			\$ -	\$ 1,050,000	\$ -	\$ 1,050,000		
Pump Stations	P-1	Bell East Pump Station - Zone 3 constant pressure	\$ 2,605,000			\$ 2,605,000	Growth, Reliability	
	P-2	Bell West Pump Station - Zone 2 constant pressure; mains Bell West P.S. to Veritas School M-14, M-15	\$ 2,017,104			\$ 2,017,104	Growth, Reliability	
<i>Pump Stations Subtotal</i>			\$ 4,622,104	\$ -	\$ -	\$ 4,622,104		
Distribution Mains ³	M-1 thru 5, M-7, 8, 18	Upsize existing mains and construct new distribution loops to improve fire flow capacity	\$ 2,085,000	\$ 901,000		\$ 2,986,000	Improve level of service - Zone 1	
	M-9	NE Zimri Drive Zone 3 distribution backbone within UGB	\$ 413,000			\$ 413,000	Growth, reliability - Zone 2 and 3	
	M-19	Chehalem Drive water system extension north to Columbia Drive		\$ 721,000		\$ 721,000	Service area extension	
	M-20	ODOT 219/N College Street - waterline relocation and valves	\$ 568,000			\$ 568,000	ODOT requirement/system maintenance	
	<i>IBTER Fire Flow improvements for increased housing density</i>						\$ 6,615,000	
	I-1	Upsize existing 6-inch mains to 8-inch mains on S Main, S Lincoln, W 4th, W 5th Streets			\$ 624,000	\$ 624,000	Growth, upsize existing	
	I-2	Upsize existing 4- and 6-inch mains to 12-inch mains on S Blaine Street		\$ 1,152,000		\$ 1,152,000	Growth, upsize existing	
	I-3a	Upsize existing 6-inch main to 8-inch main in S College Street north of E 9th Street		\$ 11,000		\$ 11,000	Growth, upsize existing	
	I-3b	Upsize existing 6-inch mains to 12-inch mains in E 9th Street, Charles Street, and S College Street		\$ 1,321,000		\$ 1,321,000	Growth, upsize existing	
	I-4a	Upsize existing 6-inch main to 8-inch main in S Meridian Street north of E 5th Street			\$ 16,000	\$ 16,000	Growth, upsize existing	
	I-4b	Upsize existing 6-inch main to 12-inch main in S Meridian Street			\$ 329,000	\$ 329,000	Growth, upsize existing	
	I-5	Upsize existing 4- and 6-inch mains to 12-inch mains in E 7th Street, S Pacific Street, E 9th Street, and Paradise Drive	\$ 1,662,000			\$ 1,662,000	Growth, upsize existing	
	I-6	Upsize existing 6-inch mains to 12-inch mains in S River Street (north of the by-pass)		\$ 1,232,000		\$ 1,232,000	Growth, upsize existing	
	I-7	Upsize existing 6-inch mains to 12-inch mains in E 5th Street			\$ 204,000	\$ 204,000	Growth, upsize existing	
	I-8	Upsize existing 6-inch main to 8-inch main from E 11th Street to the Boston Square Apartments			\$ 58,000	\$ 58,000	Growth, upsize existing	
	I-9	Upsize existing 6-inch main to 8-inch main in Vermillion Street			\$ 6,000	\$ 6,000	Growth, upsize existing	
	<i>RMP Riverfront area improvements</i>						\$ 4,564,000	
	RMP-1 thru 4, 8, & 9	New water mains to serve future development in Riverfront area		\$ 1,831,000	\$ 1,831,000	\$ 3,662,000	Growth, Zone 1 not currently served	
	RMP-5	Upsize existing 6-inch S College St main to 8-inch main to serve future Riverfront development		\$ 301,000		\$ 301,000	Growth, upsize existing	
	RMP-6, 7	Upsize existing 6-inch River and 11th St mains to 12-inch mains to serve future Riverfront development (south of the by-pass)		\$ 601,000		\$ 601,000	Growth, upsize existing	
	Seismic resilience - cast iron and concrete pipe replacement		\$ 500,000	\$ 1,000,000	\$ 1,500,000	Resilience		
	Routine Main Replacement Program	\$ 875,500	\$ 1,000,000	\$ 2,000,000	\$ 3,875,500	Asset renewal, reliability		
<i>Distribution Mains Subtotal</i>			\$ 5,603,500	\$ 9,571,000	\$ 6,068,000	\$ 21,242,500		
Future High Elevation Water Infrastructure	R-1	1.7 MG Bell Road Reservoir - Zone 3			\$ 2,886,000	\$ 2,886,000	Growth, reliability	
	M-16	Zimri Drive East transmission main to Bell Road Reservoir			\$ 3,078,000	\$ 3,078,000	Growth, reliability	
	M-17	Bell Road west transmission main - N College Street to Zimri Drive			\$ 2,678,000	\$ 2,678,000	Growth, reliability	
<i>Zone 2, 3, 4 Infrastructure Subtotal</i>			\$ -	\$ -	\$ 8,642,000	\$ 8,642,000		
Planning		Water Management & Conservation Plan update		\$ 150,000		\$ 150,000	Requirement	
		Water Master Plan update			\$ 300,000	\$ 300,000	Requirement	
		AWIA Risk & Resilience Assessment	\$ 103,000			\$ 103,000	Requirement	
	<i>Seismic resilience planning</i>							
		Develop new engineering standards		\$ 50,000		\$ 50,000	Resilience	
		Additional geotechnical investigations to define geohazards		\$ 75,000		\$ 75,000	Resilience	
		Investigate specific structural recommendations at existing WTP and other City facilities		\$ 100,000		\$ 100,000	Resilience	
	Evaluate mitigation strategies for raw water pipeline bridge		\$ 75,000		\$ 75,000	Resilience		
<i>Planning Subtotal</i>			\$ 103,000	\$ 450,000	\$ 300,000	\$ 853,000		
Other		Fixed base automatic meter reading infrastructure (AMI)	\$ 453,998			\$ 453,998	Efficiency	
		North non-potable water line and Otis Springs pumping improvements		\$ 2,105,000		\$ 2,105,000	Non-potable system growth	
		Public Works Maintenance Facility Master Plan	\$ 844,145			\$ 844,145		
<i>Other Subtotal</i>			\$ 1,298,143	\$ 2,105,000	\$ -	\$ 3,403,143		
<i>CIP Total</i>			\$ 16,041,747	\$ 21,676,000	\$ 15,010,000	\$ 52,727,747		

Table 9
2017 WMP References

Technical Update memo page or reference	2017 WMP Report Section		Description
	Section or reference	Page	
Table 1	Table 2-1	2-3	Historical Water Demand Summary - add data through 2020
Table 2	Table 2-3	2-5	Future Water Demand Summary - update 2035 to 2041, add Riverfront
Table 3, Page 5 Riverfront	Table 2-4	2-6	Future Water Demand by Pressure Zone - update Zone 1, all Riverfront demand is in Zone 1
Table 4	Section 3	3-8	Criteria summary - add recommended fire flow for new Riverfront zoning designations
Page 10 Supply	Section 4	4-8	Treatment capacity summary text - update with projected 20-year demands and operational strategy to address deficiency
Page 10 Distribution System Analysis	Table 5-1 & 5-2	5-5	Storage and pumping analysis tables - update Zone 1 required capacity based on change in 20-year demand with Riverfront, no impact to capacity
Table 8	Table 7-5	7-15	CIP Table - replace with updated



**Water Master Plan
 Technical Update**

**Figure 2
 Riverfront (RMP) &
 Middle Housing (IBTER)
 CIP Projects**

Technical Memorandum

Date: October 30, 2020

Project: Newberg Water Master Plan (WMP) Technical Update

To: Brett Musick, P.E.
City of Newberg Engineering

From: Heidi Springer, P.E.
MurraySmith

Re: Water system analysis results to inform Infrastructure Based Time Extension Request (IBTER) for Oregon House Bill 2001 (HB 2001) Missing Middle Housing

This project is funded by Oregon general fund dollars through the Department of Land Conservation and Development. The contents of this document do not necessarily reflect the views or policies of the State of Oregon.

Introduction and Purpose

This memo documents an analysis of the estimated impact of increased residential housing density on water system infrastructure in two areas of the City of Newberg (City). Increased housing density is anticipated as result of 2019 Oregon legislation, House Bill (HB) 2001 Missing Middle Housing, which requires updates to local laws throughout Oregon that currently limit the types of housing approved for construction in residentially zoned areas. The City will adopt regulations that will allow for the development of duplexes and other types of middle housing in areas zoned for residential development to comply with this legislation and address needed housing types for residents at all income levels.

This analysis was conducted to inform an Infrastructure-Based Time Extension Request (IBTER) as described in Oregon Administrative Rules (OARs) 660-046-0300 to 0370 which became effective August 7, 2020. An approved IBTER would grant the City additional time to comply with the requirements of HB 2001 Missing Middle Housing.

IBTER Study Areas

City staff identified two areas for infrastructure analysis to inform an IBTER:

- North of Downtown Newberg - up to the rail line that runs through Newberg to Hess Creek (**Figure 1**)
- South of Downtown Newberg - from the Chehalem Creek and railroad line intersection to the WestRock line and Hess Creek (**Figure 2**)

Water System Background

The existing Newberg water system is served almost entirely as a single pressure zone, Zone 1. Both IBTER study areas are in Zone 1. Zone 1 customers receive pressure from three finished water storage reservoirs, North Valley Reservoirs 1 and 2 north of downtown and Corral Creek Reservoir east of downtown. These reservoirs are filled through the distribution system pipe network by pumps at the City's Water Treatment Plant on the Willamette River near the former WestRock mill site. The WTP is supplied by the City's wellfield on the south side of the Willamette River across from the WTP.

In general, the City's distribution system runs at relatively high pressures with most customers receiving near 80 pounds per square inch (psi), which is the Oregon Plumbing Code service pressure maximum.

The City adopted the current Water Master Plan (WMP) in 2017. The current WMP identifies a single distribution main capital improvement program (CIP) project within the IBTER south study area, replacement of a 4-inch diameter main on Dayton Avenue to meet fire flow criteria (WMP CIP M-2).

Water System Hydraulic Analysis

Consistent with IBTER state guidelines, the following analysis considers fire flow availability and service pressure impacts, if any, resulting from increased density within the IBTER study areas. Required fire flow by land use type and acceptable service pressure ranges in the distribution system are as established in the 2017 WMP and summarized in the following paragraphs.

IBTER guidelines specify that only localized utility impacts, not system-wide impacts, should be evaluated in support of an IBTER, thus a Zone 1 storage and system-wide supply analysis are not examined in detail. In general, the City's existing Zone 1 storage and supply facilities have adequate surplus capacity, therefore a short-term storage or supply impact is not expected from increased density in these limited areas. Impacts to the distribution system piping to meet fire

flow and pressure criteria are understood to be only those improvements needed beyond what was recommended in the 2017 WMP, WMP CIP M-2.

A distribution system analysis was conducted using a steady-state hydraulic network analysis model developed and calibrated with field flow testing data for the 2017 WMP.

Water Demand

Water demands can be estimated using either water consumption billed to customers or finished water production recorded at the WTP. For planning purposes, water consumption from billing records is used to assign water use geographically throughout the water system model based on service address. However, water consumption data does not capture non-revenue water, such as minor leaks and maintenance uses like hydrant flushing for water quality. To account for non-revenue water uses, distributed demands by customer service address are scaled up in the model to match water produced by the WTP. This approach effectively distributes non-revenue water evenly throughout the distribution system.

Water Demand Metrics

Water demand is described using two metrics:

- Average Daily Demand (ADD) – the total water production for a given year divided by 365 days
- Maximum Day Demand (MDD) – the largest calendar day (24 hours) water production for a given year; in Newberg and western Oregon, maximum day demand occurs between July 1 and September 30th each year (this is referred to as the peak season)

Demand per Dwelling Unit

In systems with primarily residential demands like Newberg, it can be useful to estimate a demand per person per day measured in gallons per capita day (gpcd). This is estimated as system-wide ADD divided by the water service area population. This per capita demand implicitly includes all non-residential water system demands and can be used to forecast future water demands based on population growth or new residential unit construction. **Table 1** summarizes estimated demand per dwelling unit based on historical WTP production records, Newberg population estimates from the Portland State University Population Research Center (PSU PRC), and a 2.66 average number of persons per dwelling unit from US Census data. MDD is approximately two times ADD, consistent with the 2017 WMP.

Table 1
Average Water Demand per Dwelling Unit

Year	ADD (mgd)	Population	ADD/person (gpcd)	ADD/unit (gpd)	MDD/unit (gpd)
2016	2.35	23,465	100	266	532
2017	2.35	23,480	100	266	532
2018	2.39	23,795	101	269	538
2019	2.27	24,045	94	250	500
Average ADD and MDD per Unit in gallons per day (gpd)				263	526

Estimated Growth from Increased Density due to Middle Housing

Per state IBTER guidelines in OAR 660-046-0320 and 330, the City may consider a one percent growth rate for infill development in the IBTER study areas. The City may consider a three percent growth rate for any properties considered un- or underdeveloped. Underdeveloped is defined in the OARs as a larger than one-half acre parcel zoned for detached single-family housing which has an existing density of less than or equal to two units per acre.

City Planning staff provided detailed parcel information for each area and identified parcels which may be considered underdeveloped. Estimated growth in dwelling units for the IBTER study areas based on this parcel data and the OAR guidelines is summarized in **Table 2**.

Table 2
Estimated Dwelling Unit Growth

IBTER Area	Existing Units			Infll Growth Units	Redevelopment Growth Units
	Developed Parcels	Underdeveloped Parcels	TOTAL Existing Units	(1% for existing developed)	(3% for existing underdeveloped)
South of Newberg	1,485	36	1,521	18	3
Single Family	879	35	914	9	2
Multi Family	428	-	428	5	-
Duplex	125	1	126	2	1
Triplex	21	-	21	1	-
Fourplex	32	-	32	1	-
North of Newberg	176	-	176	3	-
Single Family	170	-	170	2	-
Multi Family	-	-	-	-	-
Duplex	6	-	6	1	-
TOTAL Existing Units			1,697	TOTAL Growth	24

Estimated Study Area Demand

Current demand and estimated demand with middle housing growth for the IBTER study areas is summarized in **Table 3**. Current ADD was estimated based on geographic assignment of 2015 billing records in the hydraulic model for the 2017 WMP and 2019 City WTP production. As shown in **Table 1**, ADD has remained relatively constant since 2016.

Table 3
IBTER Study Area Demand Summary

Area	Current Demand (gpd)		Estimated Demand with middle housing growth (gpd)	
	ADD	MDD	ADD	MDD
South of Downtown	336,240	672,480	341,763	683,526
North of Downtown	52,070	104,141	52,859	105,719

Distribution System Performance Criteria

System performance was evaluated using pressure, pipe velocity, and required fire flow criteria established in the 2017 WMP and summarized in **Table 4**.

Table 4
Distribution Performance Criteria

Water System Component	Evaluation Criterion	2017 WMP Value	Design Standard/Guideline
Service Pressure	Normal Range, during ADD	40-80 psi	City's 2015 Public Works <i>Design and Construction Standards</i>
	Maximum, without PRV	80 psi	Oregon Plumbing Specialty Code 608.2
	Minimum, during emergency or fire flow	20 psi	OAR 333-061
Distribution Mains	Velocity during fire flow	Not to exceed 8 fps	City's 2015 Public Works <i>Design and Construction Standards</i>
	Velocity during ADD	Not to exceed 5 fps	
Required Fire Flow and Duration	Low Density – Single-Family and Duplex Residential <= 3,600 sq ft	1,000 gpm for 2 hours	Oregon Fire Code
	Single-Family and Duplex Residential >3,600 sq ft	1,500 gpm for 2 hours	
	Medium Density Residential	1,500 gpm for 2 hours	
	High Density Residential	2,000 gpm for 3 hours	
	Commercial	3,000 gpm for 3 hours	
	Industrial, Institutional, and Hospitality	4,500 gpm for 3 hours	

Assumptions and Modeling Conditions

For the purposes of this analysis, it is assumed that all Zone 1 reservoirs are operating approximately three-quarters full and the WTP is not actively pumping to fill storage reservoirs.

Analysis Findings and Distribution System Constraints

Service Pressure

Modeled main line pressures under MDD conditions in the IBTER south area are between approximately 90 and 100 psi. Pressures in the north study area range between approximately 80 and 90 psi. These mainline pressure ranges remain the same with the approximately two percent increase in water demand generated by potential middle housing increased density.

Fire Flow Availability

Fire flow availability was tested at 2,000 gallons per minute (gpm) consistent with high density residential required fire flow from **Table 4**. This 2,000 gpm fire flow may be conservative in some parts of the IBTER study areas where smaller structures with fewer units, like duplexes, are more likely to be developed. However, providing water infrastructure capable of supplying a 2,000 gpm fire flow allows the City to consider a broader range of middle housing options as HB 2001 zoning changes are evaluated.

Fire flow availability in the south IBTER study area is constrained by high pipe flow velocity. Adequate pressure is available to supply fire flow and maintain service pressures above 20 psi for public health. However, small diameter 4- and 6-inch diameter pipe grids in the south study area create flow velocities over 20 feet per second (fps) during a fire flow event. Fire flow in the north study area is less constrained with 8-inch diameter well looped existing mains interconnected with the 18-inch diameter North Valley Reservoirs transmission main.

The primary concern with high pipe velocity is abrasion of the interior pipe coating, which can expose the pipe material to corrosion and lead to potential pipe failure. This is generally a greater concern when high flow velocity extends over a long period of time as part of normal system operation. In the case of a fire flow event, these high flow velocities are both infrequent and for a short time when they do occur. Thus, a pipe velocity higher than the 8 fps specified in **Table 4** may be acceptable, provided there is adequate available pressure to supply fire flow as is the case in Newberg's IBTER south study area. According to information from the Ductile Iron Pipe Research Association (DIPRA), 14 fps is a conservative maximum pipe velocity based on satisfactory historical performance of cement mortar lined ductile iron pipe. For the purposes of this analysis available fire flow is evaluated at a flow velocity of 14 fps.

Figure 3 at the end of this memo illustrates available fire flow in the north and south IBTER study areas with existing water mains under max day demand conditions and with a maximum flow velocity of 14 fps.

Recommended Improvements

Eight significant pipe improvement projects are recommended for the south study area and one minor project is recommended for the north study area to provide adequate fire flows to potential higher density development. In the south, existing development is primarily served from a 4- and 6-inch diameter pipe grid. While a 6-inch diameter main can provide a 1,000 gpm single-family residential fire flow, a 6-inch diameter grid is inadequate to provide a 2,000 gpm multi-family residential fire flow.

Existing 6-inch diameter mains along key corridors in the south study area, including S College Street, S River Street, and E 9th Street, are recommended to be upsized to 12-inch diameter mains to provide a large diameter backbone for the area to meet 2,000 gpm fire flow requirements for potential higher density development. Additional looping is also recommended to connect larger diameter mains with the 18-inch diameter transmission main in Wynooski Street and for the W 4th Street neighborhood between Dayton Avenue and Hwy 99W.

Two areas in the southwest corner of the south study area cannot be supplied a 2,000 gpm fire flow without significant or total pipe replacement and upsizing. The first area is the S Charles Street loop, which is bordered by Chehalem Creek to the west making it difficult to connect to the water system outside of the south study area. The second area is between S College Street and S River Street just north of the Newberg Dundee Bypass, which does not have an existing east-west right-of-way to provide additional looping. Rather than replacing these pipes in their current alignments, it is instead recommended that the City assess fire flow to these areas and potential distribution system looping along with future transportation projects associated with the Riverfront area, such as the extension of S Blaine Street south of Ewing Young Park and the extension of a future road across the former WestRock mill property connecting the area around the City's WTP and NE Rogers Landing Road.

Figure 4 at the end of this memo illustrates recommended pipe improvement projects.

Cost Estimates

An estimated cost has been developed for each recommended piping improvement project. New piping is assumed to be ductile iron pipe installed by private contractors.

Cost estimates represent opinions of cost only, acknowledging that final costs of individual projects will vary depending on actual labor and material costs, market conditions for construction, regulatory factors, final project scope, project schedule and other factors. The Association for the Advancement of Cost Engineering International (AACE) classifies cost estimates depending on project definition, end usage, and other factors. The cost estimates presented here are considered Class 4 with an end use being a study or feasibility evaluation and an expected accuracy range of -30 percent to +50 percent. As the project is better defined, the accuracy level of the estimates can be narrowed.

Since construction costs change periodically, an indexing method to adjust present estimates in the future is useful. The Engineering News-Record (ENR) Construction Cost Index (CCI) is a commonly used index for this purpose. For purposes of future cost estimate updating, the current ENR CCI for Seattle, Washington is 12,771.70 (September 2020).

Recommended improvements and estimated costs are summarized in **Table 5**.

Table 5
Recommended Improvements

Project No.	Project Description	Estimated Project Cost ¹⁻⁶
I-1	Install 1,733 LF of 8-inch DI Pipe in S Main Street, W 4th Street, S Lincoln Street, and W 5th Street	\$624,000
I-2	Install 2,558 LF of 12-inch DI Pipe in S Blaine Street	\$1,152,000
I-3	Install 2,962 LF of 8- and 12-inch DI Pipe in E 9th Street, Charles Street, and S College Street	\$1,332,000
I-4	Install 772 LF of 8- and 12-inch DI Pipe in S Meridian Street	\$345,000
I-5	Install 3,691 LF of 12-inch DI Pipe in E 7th Street, S Pacific Street, E 9th Street, and Paradise Drive	\$1,662,000
I-6	Install 2,736 LF of 12-inch DI Pipe in S River Street	\$1,232,000
I-7	Install 453 LF of 12-inch DI Pipe in E 5th Street	\$204,000
I-8	Install 159 LF of 8-inch DI Pipe from E 11th Street to the Boston Square Apartments	\$58,000
I-9	Install 15 LF of 8-inch DI Pipe in Vermillion Street	\$6,000
Total Cost		\$6,615,000

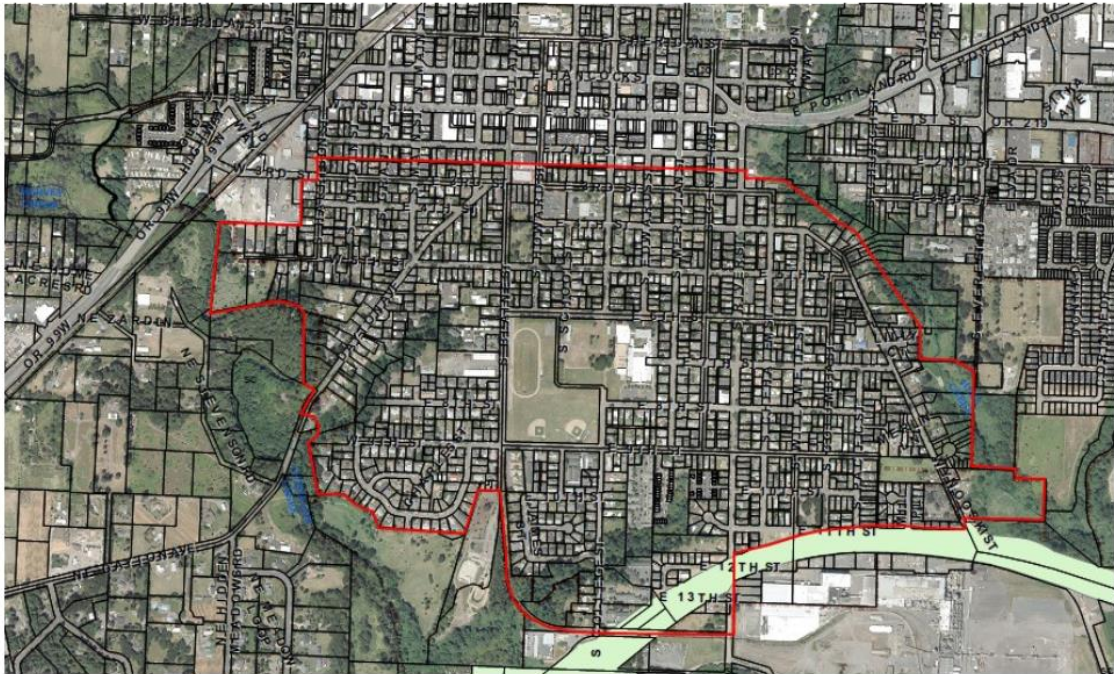
Notes:

1. All costs are in 2020 dollars
2. Includes costs for fittings/valves and connections to existing services and hydrants
3. Includes local street trench patch resurfacing; whole or half street overlays are not included
4. Includes an allowance of 30% for construction contingency, 25% for engineering, permitting and inspection, and 1% for Oregon Corporate Activity Tax (applied to construction costs only)
5. Easement and right-of-way costs are not included
6. City project management and administrative costs are not included

Figure 1: North of Downtown Newberg



Figure 2: South of Downtown Newberg



Memo

Date: Monday, July 20, 2020

Project: Seismic Resilience Assessment

To: Brett Musick, PE, City of Newberg

From: Andy McCaskill, P.E.; Katie Walker, P.E.

Subject: Executive Summary

Introduction

The City of Newberg (City) operates a water system consisting of a wellfield, raw water transmission pipelines, a water treatment plant, three water storage reservoirs, one pump station, and distribution system pipelines. In support of the 2017 Water Master Plan and Oregon Health Authority (OHA) guidelines, the City conducted a water system seismic resilience assessment (SRA). The purpose of the SRA is to define level-of-service (LOS) goals, evaluate the expected performance of the system during a Cascadia Subduction Zone (CSZ) earthquake, and identify recommended mitigation measures to address deficiencies. The SRA included the following studies:

- Seismic Resiliency Goals – during this study, goals and retrofit performance criteria were defined (see Appendix A).
- Geotechnical Engineering Report (GER) – during this study, geotechnical conditions were reviewed to identify seismic hazards (see Appendix B).
- Vulnerabilities Assessments – the purpose of this report was to assess the vulnerabilities of the City’s water system and the pipeline bridge (see Appendix C).
- Mitigation Recommendations – mitigation strategies were recommended and developed at a conceptual level to address some system vulnerabilities (see Appendix D).
- Recommendations for Future Studies – additional studies were identified to clarify and confirm the City’s seismic mitigation needs (see Appendix E).

This executive summary presents the purpose and key findings from each study.

Seismic Recovery Goals

In this study, the water system level of service goals were established to define performance expectations after a CSZ earthquake. A collaborative workshop was conducted to identify the restoration priorities for the City with short-term (no disruption) needs including fire suppression and the Providence Newberg Medical Center. Using guidelines in the Oregon Resilience Plan (ORP) tailored to the City’s needs, recovery goals were identified for all major components of the water system (see Attachment A).

The study also identified the backbone of the City’s water system, which are the components required to meet the short-term needs outlined in the recovery goals (see Attachment B). These

components should be designed or modified to experience only minor damage during a CSZ earthquake.

In addition to defining goals and identifying the system backbone, objectives for retrofitting existing water system components were identified based on how quickly they could be restored.

Geotechnical Engineering Report

The GER included a review of the existing geologic and geotechnical conditions to develop seismic ground motion, seismic hazard, and permanent ground deformation hazard maps. At the WTP, the following was conducted:

- One boring
- Evaluation of liquefaction potential and liquefaction-induced settlement
- Evaluation of potential for slope failure
- Evaluation of seismically induced ground movement and potential for lateral spread

Vulnerabilities Assessment

In the Vulnerabilities Assessments, water system components were compared against the seismic hazard maps developed in the GER showing peak ground velocity, probability of liquefaction, and landslide induced permanent ground deformation. In addition to a desktop review, a site visit was conducted to inspect the water system and interview City personnel. Based on the assessment, the following vulnerabilities were identified:

Pipeline Bridge

A desktop assessment was conducted to review the bridge, but record drawings were not available. The assessment concluded that the bridge and transmission main are unlikely to survive a CSZ earthquake. A retrofit, likely costing in the tens-of-millions, would be required with additional studies and inspections needed to clarify and confirm the bridge conditions.

Wellfield

In general, the wells are likely at risk for liquefaction and lateral spread. During a CSZ earthquake, differential settlement could occur between the well casing and pipe connection, the well screen could be plugged, and the seismic shaking could cause groundwater levels to fluctuate. Additional vulnerabilities include lack of backup power and lack of reliable access across the river.

30-inch HDPE Transmission Main

Based on a review of the geotechnical documents from the construction of the main, the transmission main is susceptible to liquefaction induced settlement on the southern side of the river, and at the shallowest section on the northern side of the river. These conditions would likely result in differential settlement causing pipe separation or damage during a CSZ earthquake.

Water Treatment Plant

Studies conducted at the WTP indicate up to two feet of lateral spread displacements at a distance of approximately 300 feet from the crest of the slope during a CSZ earthquake. Stability analyses also showed seismically induced ground displacements in the range of approximately 7.5 feet. In addition, the review of the slope indicated that it is only marginally stable under static conditions and not stable in seismic or post-seismic conditions.

A site visit was conducted to assess components at the WTP. In general, the review of the structures indicated that none meet either the structural or non-structural performance objectives outlined as part of the Seismic Recovery Goals. Significant work is required at the WTP to meet recovery goals, and it was recommended that further evaluation be conducted to compare the cost of upgrading the WTP versus building a new WTP. However, it should be noted that while the buildings will not withstand a CSZ event, the plant site itself is not susceptible to a landslide into the river.

Water System Backbone

The seismic hazard maps prepared under the GER were applied against pipeline information, such as age, corrosion, and material, to identify the estimated number of pipeline breaks and length of repair. For the non-landslide areas, it is estimated that 245 breaks will occur (see Attachment C, Table 1). For the landslide prone areas, a range of 84 to 626 breaks will occur (see Attachment C, Table 2).

Water Distribution Pipelines

The water distribution network is considered a lower priority for seismic resilience based on the LOS goals established by the City. For the non-landslide areas, it is estimated that 1,159 water breaks will occur (see Attachment C, Table 3). For the landslide prone areas, a range of 336 to 2,518 breaks will occur (see Attachment C, Table 4).

WTP Yard Piping

Several vulnerabilities exist at the WTP including:

- Lack of isolation valves at the WTP to prevent water loss or cross contamination, or preserve water storage at the WTP
- Lack of a WTP bypass line to supply water from the wellfield to the distribution for firefighting or domestic use (boiling required for potable use)
- Lack of seismic couplings at building pipeline penetrations to prevent pipe separation

Water Storage Tanks Yard Piping

Vulnerabilities at the Corral Creek Site include:

- Flexible couplings may need to be replaced with seismic couplings to provide more movement during an earthquake
- Lack of seismic couplings on the pipeline to prevent pipe separation
- Lack of a hydraulic control valve to quickly protect water storage if a loss of power or SCADA occurs

Vulnerabilities at the North Valley Water Storage Tanks include:

- Unknown capabilities of couplings at pipe penetrations
- Inlet/outlet line will be subject to landslide movements and pipeline separation
- Lack of a hydraulic control valve to quickly protect water storage if a loss of power or SCADA occurs

Water System Operations

Vulnerabilities and observations related to water system operations include:

- No fire flow or pressure deficiencies were identified that could affect system recovery after a CSZ earthquake
- No deficiencies in water system storage capacity
- SCADA system could be improved or expanded to include greater centralized monitoring and control of the system, with backup power and communications improved at identified locations
- Lack of a redundant water supply, which is currently being investigated under another study
- Ensure GIS mapping is adequately detailed to locate critical isolation valves and facilities in an emergency.

Mitigation Recommendations

The Vulnerabilities Assessment identified areas where the City needs to improve or retrofit the water system. The following five mitigation strategies were identified as top priorities for the City. Mitigation strategies were presented in two separate memos: one for recommendations at the WTP and one for recommendations within the distribution and storage system.

Rehabilitation of Existing WTP

The existing WTP is susceptible to liquefaction, ground deformation, and lateral spreading. The goal of rehabilitation is to address the deficiencies identified in previous studies by installing ground improvements between the WTP site and the shoreline to prevent lateral movement and strengthening structural components to withstand a CSZ event. The range of construction cost estimates could be from \$3.3M to \$13M.

Construction of Greenfield WTP

Since several structures at the existing WTP are nearing the end of their useful life, an alternative strategy is to replace the existing plant with a seismically resilient one. The range of construction cost for a new plant could be from \$12.3M to \$49.2M.

Emergency Connection and Control at the WTP

As identified in the vulnerability assessment, the WTP poses several risks if a CSZ earthquake occurs. By adding a point for emergency cross-connection and installing hydraulic control valves, the plant could be isolated during an earthquake event, allowing raw water to continue

into the distribution system. The construction cost for these improvements is approximately \$500K.

Improvements to Water Storage

The vulnerability assessment identified the potential for water loss at the storage tanks during a CSZ earthquake. By adding hydraulic control valves and replacing a portion of the pipe at North Valley Water Storage Tanks, water storage at the tanks could be preserved. The construction for the improvements at the Corral Creek Site is approximately \$300K, and \$750K at the North Valley Water Storage Tanks.

Cast Iron and Concrete Pipe Replacement

Based on the evaluation of pipeline in the City's backbone, old cast iron and concrete pipe poses the greatest risk for damage during a CSZ earthquake. The construction costs for the replacement of pipe is approximately \$12.5M and represents the replacement of more than 37,000 linear feet of pipe.

Recommendations for Future Studies

To further refine mitigation strategies, additional studies are required. Studies recommended include the following list (Note that this list is not all-inclusive as other efforts will likely be identified):

- Develop new engineering standards to address seismic resiliency needs in new infrastructure or buildings
- Identification of alternative water demands that could impact water storage available within the system
- Additional geotechnical investigations to better classify the seismic hazards that the water system may experience and allow the City to focus on the most hazardous areas.
- Investigate specific structural recommendations for structures at the WTP and other City facilities
- Evaluate specific mitigation strategies for the pipeline bridge
- Investigate additional mitigation strategies that address remaining vulnerabilities



Attachment A:
Water System Recovery Goals



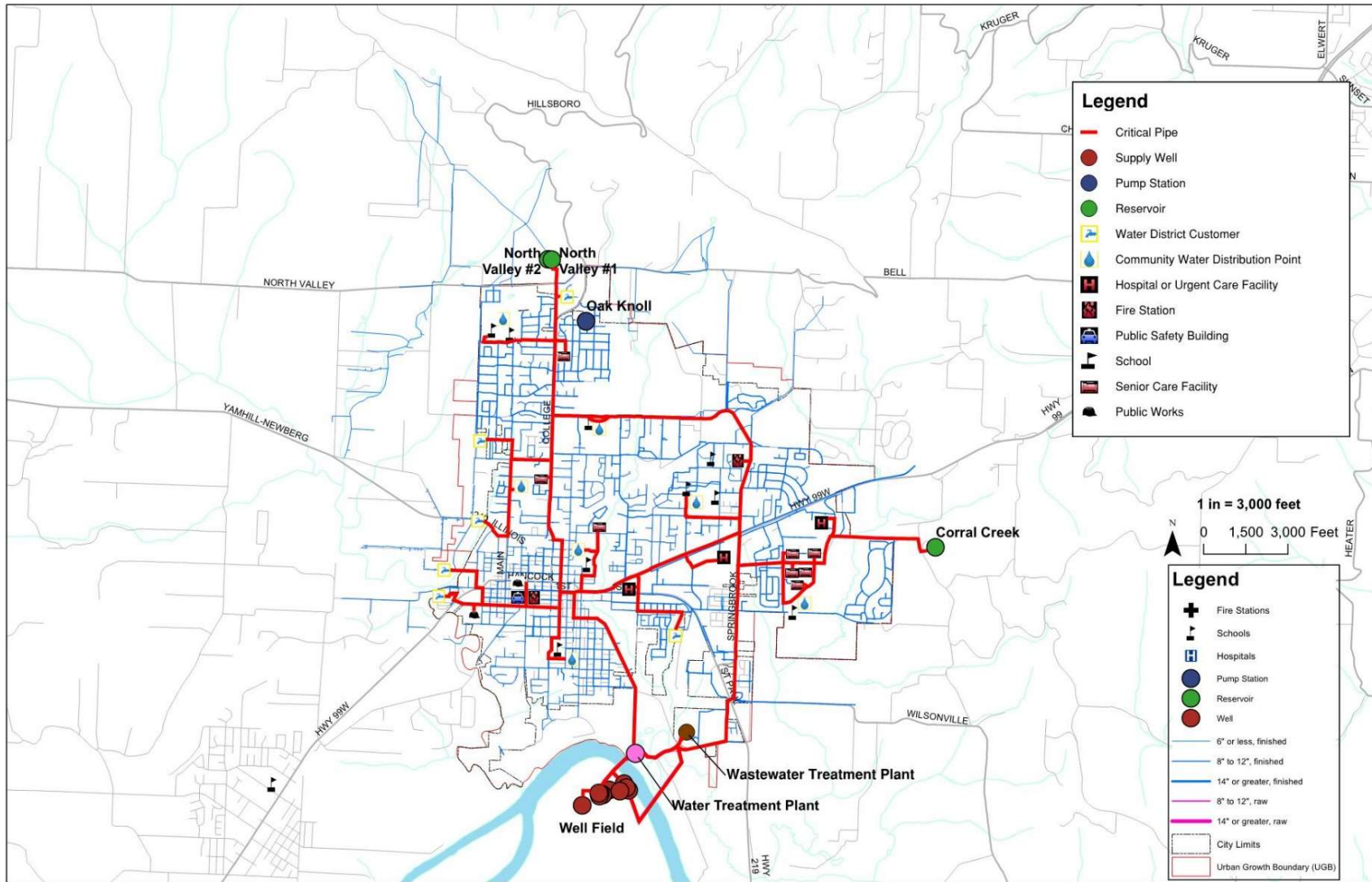
City of Newberg Water System Recovery Goals
(adapted from OSSPAC 2013 and NIST 2015)

Water Systems	Target Timeframe for Recovery							
	Phase 1: Short-Term			Phase 2: Intermediate			Phase 3: Long-Term	
	Days			Weeks			Months	
	0-1	1-3	3-7	1-2	2-4	4-12	3-6	6-12
Source								
Raw or source water and terminal reservoirs	R	Y		G				
Raw water conveyance (pump stations and piping to WTP)	R	Y		G				
Water Production	R	Y		G				
Well and/or Treatment operations functional	R	Y		G				
Transmission (including Booster Stations)								
Backbone transmission facilities (pipelines, pump station, and tanks)	G							
Water for fire suppression at key supply points (to promote redundancy)	G							
Control Systems								
SCADA and other control systems	G							
Distribution								
Critical Facilities								
Wholesale Users (other communities, rural water districts)	G							
Hospitals	G							
EOC, Police Stations, Fire Stations, Public Works Buildings	Y	G						
Emergency Housing								
Emergency Shelters	Y	G						
Housing/Neighborhoods								
Potable water available at community distribution centers		Y	G					
Water for fire suppression at fire hydrants			R	Y	G			
Community Recovery Infrastructure								
All other clusters			R	Y	G			

Key to Table
 Desired time to restore components to 30% operational R
 Desired time to restore components to 60% operational Y
 Desired time to restore components to 90% operational G



Attachment B:
Water System Backbone Map





Attachment C:
Water System Summary Tables



Table 1. Water System Backbone Summary, Non-Landslide Areas

Pipe Material	Total Material Length Within Geo-Hazard (ft)	Percentage of Backbone Total	Est. Total No. of Breaks	Est. No. of Breaks per 1,000 ft.	Est. Space Between Breaks (ft)
Cast Iron	23,860	25%	89	4	268
Ductile Iron	58,433	62%	109	2	536
RCC	12,592	13%	47	4	268
Grand Total	94,884	100%	245	3	387

Table note: Estimated Number of Breaks Due to peak ground velocity (PGV) and peak ground deformation (PGD) (non-landslide) by Pipe Material

Table 2. Water System Backbone Summary, Landslide Areas

Pipe Material	Total Material Length Within Geo-Hazard(ft.)	Percentage of Backbone Total	Est. Total No. of Breaks	Est. No. of Breaks per 1,000 ft.	Est. Space Between Breaks (ft.)
Cast Iron	1,193	1%	30-228	25-191	5-39
Ductile Iron	2,922	3%	37-279	13-95	10-79
RCC	630	1%	16-120	25-191	5-39
Grand Total	4,744	5%	84-626	64-477	5-79

Table note: Estimated Number of Breaks Due to PGD (landslide) by Pipe Material

Table 3. Water Distribution System Summary, Non-Landslide Areas

Pipe Material	Total Material Length Within Geo-Hazard (ft)	Percentage of Distribution Total	Est. Total No. of Breaks	Est. No. of Breaks per 1,000 ft.	Est. Space Between Breaks (ft)
C-900	11,713	3%	35	3	336
CI	106,470	23%	397	4	268
DI	296,271	63%	553	2	536
PVC	28,707	6%	85	3	336
Other	23,905	5%	89	4	268
Grand Total	467,065	100%	1,159	2	403

Table note: Estimated Number of Breaks Due to PGV and PGD (non-landslide) by Pipe Material

Table 4. Water Distribution System Summary, Landslide Areas

Pipe Material	Total Material Length Within Geo-Hazard(ft.)	Percentage of Distribution Total	Est. Total No. of Breaks	Est. No. of Breaks per 1,000 ft.	Est. Space Between Breaks (ft.)
C-900	586	3%	12-89	20-153	7-49
CI	5,324	23%	135-1,016	25-191	5-39
DI	14,814	63%	188-1,413	13-95	10-79
PVC	1,435	6%	29-219	20-153	7-49
Other	1,195	5%	30-228	25-191	5-39
Grand Total	23,353	100%	336-2,518	59-439	5-79

Table note: Estimated Number of Breaks Due to PGD (landslide) by Pipe Material



Appendix A: Seismic Resiliency Goals



WATER SYSTEM SEISMIC RESILIENCE STUDY

**CITY OF NEWBERG PUBLIC WORKS DEPARTMENT
NEWBERG, OREGON**

Final Technical Memorandum: Seismic Recovery Goals

August 16th, 2019

SEFT Project Number: B19009.00

Table of Contents

List of Figures	ii
List of Tables.....	iii
1.0 Introduction and Background	1
1.1 City of Newberg Water System Description	1
1.2 Seismic Resilience Study.....	1
1.3 Resilience Planning by Other Metro Region Agencies.....	2
2.0 Community Resilience.....	3
2.1 Definition	4
2.2 Planning Process	4
2.3 Seismic Hazard	4
3.0 Level of Service Goals	8
3.1 SPUR Resilient City	8
3.2 Oregon Resilience Plan	8
3.3 NIST Community Resilience Planning Guide.....	10
3.4 San Francisco Public Utilities Commission	11
3.5 Community Needs Following a Major Earthquake	12
3.6 Water Supply Points for Fire Suppression	14
3.7 Community Water Distribution Points.....	14
3.8 City of Newberg Water System Level of Service Goals	16
4.0 City of Newberg Backbone System Supporting Short-Term Community Needs.....	18
5.0 Translation of Level of Service Goals into System Performance Requirements	20
5.1 Considerations	20
5.1.1 Geotechnical Hazards.....	20
5.1.2 Effects of Aftershocks	20
5.1.3 Repair Difficulty.....	20
5.1.4 Availability of Public Works Department Staff	21
5.1.5 Availability of Design Professionals and Contractors	21
5.1.6 Availability of Repair Materials or Replacement Equipment.....	21
5.1.7 Infrastructure Dependencies	21
5.2 Water System Structures	23
6.0 Limitations	28
References	29

List of Figures

Figure 2.1 – Six-Step Process to Planning for Community Resilience.....	6
Figure 2.2 – Oregon and Northern Japan Mirror Image Subduction Zones	7
Figure 2.3 – Historic Cascadia Subduction Zone Earthquake Timeline	7
Figure 3.1 – Potential Water Supply Points for Fire Suppression	15
Figure 3.2 – Potential Community Water Distribution Points	15
Figure 4.1 – City of Newberg Water System Backbone	19

List of Tables

Table 3.1 – ORP Water System Recovery Goals: Valley Zone	10
Table 3.2 – City of Newberg Social/Economic Recovery Goals.....	13
Table 3.3 – City of Newberg Water System Recovery Goals.....	17

1.0 Introduction and Background

1.1 City of Newberg Water System Description

The City of Newberg water system currently consists of the City’s wellfield, raw water transmission pipelines, water treatment plant, three water storage reservoirs, one pump station, and distribution system pipelines. The entire water service area is one pressure zone, except for approximately 40 customers that are served by the Oak Knoll booster pump station. The system uses approximately 56 miles of distribution pipelines to provide water to business and residential customers within the City of Newberg service area and six small water district wholesale customers. The primary water supply is the City’s well field located on the south side of the Willamette River in Marion County. Two raw water transmission mains cross the river to the treatment plant. An under river 30-inch diameter high density polyethylene transmission main can supply 100% of the treatment plant capacity. An older 24-inch diameter cast iron transmission main is supported by a decommissioned highway bridge. The City’s water treatment plant is a conventional filtration facility with a nominal capacity of 9 million gallons per day (MGD). The current average day demand for the water system is approximately 2.4 MGD and summertime demands can increase to approximately 4.5 MGD.

1.2 Seismic Resilience Study

Based on recommendations contained in the 2017 City of Newberg Water Master Plan and requirements of the Oregon Health Authority, the City of Newberg is conducting a water system seismic resilience study. This study will evaluate the expected performance of the City water system following a Magnitude 9.0 (M9.0) Cascadia Subduction Zone (CSZ) earthquake and identify preliminary recommendations for improvements that should be implemented to enable the City to more rapidly restore water service after a major earthquake, to meet community social and economic needs. The scope of this seismic resilience study includes:

1. Define water system level of service (LOS) goals for the City water system following a major seismic event;
2. Identify key backbone system components that are required to achieve these LOS goals, including the locations of key supply points for water for fire suppression and community water distribution;
3. Define performance criteria for individual system components that are required to achieve these LOS goals;
4. Conduct a limited geotechnical seismic hazards evaluation for the City water system and slope stability analysis at the water treatment plant site (Shannon & Wilson);
5. Conduct a limited well/pipeline (HDR), and structural/nonstructural (SEFT/HDR) vulnerability assessment to determine estimated system performance following a M9.0 CSZ earthquake;

6. Identify gaps between the LOS goals and current performance estimates; and
7. Develop preliminary mitigation recommendations to close these gaps utilizing new or retrofit infrastructure, changes to design standards, enhancements in emergency response planning, and recommendations for further study.

This Technical Memorandum (TM) presents the HDR team recommendations related to scope items 1 through 3.

1.3 Resilience Planning by Other Metro Region Agencies

The resilience planning effort being undertaken by the City of Newberg is similar to the planning activities undertaken by several Portland metro region agencies. Additionally, numerous other agencies on the west coast of the United States and Canada are actively conducting resilience planning and resilience-based capital improvement projects.

Tualatin Valley Water District, City of Hillsboro Water Department, and Willamette Water Supply Program

TVWD and the City of Hillsboro Water Department have each completed a water system resilience plan and they are partnering to complete the billion-dollar Willamette Water Supply Program (WWSP) to provide an additional water supply for the region. When complete, the WWSP will greatly enhance the ability of the partner agencies to deliver water to their customers immediately after a major earthquake by providing a resilient and reliable water supply for the region, designed to meet stringent seismic performance goals.

City of Portland

The Portland Water Bureau has completed a water system resilience planning project and is beginning to incorporate recommendations from the plan into their capital improvement projects. The Bureau of Environmental Services has completed a wastewater system seismic resilience master plan and has already begun to incorporate early action item recommendations into practice.

City of Gresham

The City of Gresham has completed resilience planning projects for both their water and wastewater systems and are beginning to incorporate recommendations from these plans into their capital improvement projects. They have successfully leveraged their water system resilience plan to obtain Federal Emergency Management Agency pre-disaster mitigation grant funding to implement seismic improvements at one of their water reservoirs.

2.0 Community Resilience

Events like Hurricane Katrina in 2005, the Great East Japan M9.0 Earthquake and Tsunami in 2011, and Hurricane Sandy in 2012 have underscored the devastating impacts that natural disasters can inflict at a local, regional, state, and multi-state level. The Federal government has defined the National Preparedness Goal as: “A secure and resilient Nation with the capabilities required across the whole community to prevent, protect against, mitigate, respond to, and recover from the threats and hazards that pose the greatest risk” (FEMA, 2015).

One strategy to achieve this National Preparedness Goal is to plan for and implement programs and strategies to improve disaster resilience at the local, regional, state, and national level. Oregon is a national leader in community resilience. In February of 2013, the Oregon Seismic Safety Policy Advisory Commission submitted a report to the 77th Legislative Assembly entitled the *Oregon Resilience Plan: Reducing Risk and Improving Recovery for the Next Cascadia Earthquake and Tsunami* (OSSPAC, 2013). The report discussed the risk that is faced by the citizens of Oregon from an impending Cascadia Subduction Zone earthquake and accompanying tsunami, and the gaps that exist between the current state of Oregon’s infrastructure and where it needs to be. In addition to life safety impacts, the report also highlighted the economic vulnerabilities to individuals and communities from such an event. The *ORP* went on to outline steps that can be taken over the next 50 years to bring the state closer to resilient performance through a systematic program of vulnerability assessments, capital investments in public infrastructure, new incentives to engage the private sector, and policy changes that reflect current understanding of the Cascadia threat. While the *ORP* specifically addresses improving resilience in the aftermath of a major earthquake, implementation of the plan is also expected to improve resilience for other hazards.

A primary focus of the *ORP* goals is to minimize the long-term economic damage associated with the potential out-migration of businesses and population that would be expected to occur following a major disaster if basic services cannot be restored rapidly enough to meet the communities social and economic needs. Resilience of the water system will be key to the region’s economic recovery. For example, the fundamental goal of quickly restoring the supply of safe drinking water to homes and businesses will help to enable residents to shelter-in-place and businesses to resume operation as quickly as possible after the event. Small businesses are particularly vulnerable to being closed for an unplanned amount of time and many may not be able to re-open if closed for more than a month. Each business closing negatively impacts employment, tax revenue, and the long-term economic and social viability of the City. The more rapidly that businesses are able to reopen, the quicker revenue will normalize, and money will circulate within the region’s economy. At a fundamental level, the water system must be functioning at a certain level for service fees to be collected to provide revenue for the City of Newberg to sustain everyday functions and to help fund the recovery process.

2.1 Definition

In the field of community disaster planning, a common definition of “resilience” has been put forth by Presidential Policy Directive (PPD). PPD-8 [2011] defines resilience as “the ability to adapt to changing conditions and withstand and rapidly recover from disruption due to emergencies.” PPD-21 [2013] refined the definition to “...the ability to prepare for and adapt to changing conditions and to withstand and recover rapidly from disruptions. Resilience includes the ability to withstand and recover from deliberate attacks, accidents, or naturally occurring threats or incidents.”

2.2 Planning Process

While varied forms of community disaster preparedness planning have been taking place for decades, a specific focus on community resilience has developed over about the last 10 years. In 2015, the National Institute of Standards and Technology (NIST) published NIST Special Publication 1190, *Community Resilience Planning Guide for Buildings and Infrastructure Systems* (NIST, 2015). The *Guide* outlines a consistent framework for a six-step resilience planning process (see Figure 2.1) that is designed to be conducted at a community level, involving broad representation from local and regional government, building owners, infrastructure system owner/operators, and community representatives. The *Guide* process can also be adapted to resilience planning for a specific infrastructure system (e.g. water system), with some limitations. One of the main limitations of an individual infrastructure system planning approach is that it requires assumptions to be made that can’t be tested with community stakeholders and other infrastructure system providers. For instance, operation of water pump stations requires commercial electrical power or emergency generators with adequate fuel supplies. The timeline for restoration of commercial electrical power or availability of fuel for generators is largely controlled by stakeholders that aren’t involved in a water system only planning scenario.

2.3 Seismic Hazard

One of the initial steps in the resilience planning process involves determining the specific hazards to be safeguarded against. Consistent with Oregon Health Authority requirements, the City of Newberg has selected a M9.0 Cascadia Subduction Zone scenario earthquake as the hazard to be explicitly considered for this seismic resilience study.

The geologic and seismologic information available for identifying the potential seismicity throughout the State of Oregon is continually evolving, and large uncertainties are associated with estimates of the probable magnitude, location, and frequency of occurrence of earthquakes. The available information indicates the potential seismic sources that may affect the state can be grouped into three categories:

- Subduction zone events related to sudden slip between the upper surface of the Juan de Fuca plate and the lower surface of the North American plate,
- Subcrustal events related to deformation and volume changes within the subducted mass of the Juan de Fuca plate, and
- Local crustal events associated with movement on shallow, local faults.

A major contributor to the seismic hazard in western Oregon is the Cascadia Subduction Zone (CSZ) that lies off the coast of Oregon, Washington, Northern California, and British Columbia. The CSZ is an active plate boundary along which the remnants of the Farallon Plate (the Gorda, Juan de Fuca and Explorer plates) are being subducted beneath the western edge of the North American continent. Figure 2.2 shows that the subduction zone off the coast of Oregon is a mirror image of the subduction zone off the coast of Northern Japan that produced the deadly Magnitude 9.0 Tohoku earthquake in 2011. Seismologists anticipate that the strong shaking from a CSZ earthquake will last from 3 to 5 minutes, much longer than the 30-second strong shaking experienced in a typical California earthquake.

Seismologists' understanding of the damaging earthquakes produced by the CSZ has steadily increased over the past 25 years. Research by the Oregon Department of Geology and Mineral Industries (DOGAMI), Oregon State University, and others has provided evidence of the timeline of historic great CSZ earthquakes. The timeline of these 41 earthquakes over the last 10,000 years is provided in Figure 2.3, showing that past earthquakes have occurred at highly variable intervals, and can range widely in size and in which parts of the Pacific Northwest they affected. The rupture distance for these CSZ earthquakes varies from a short rupture along the Northern California and Southern Oregon Coast, to a rupture along the entire length of the subduction zone from Northern California to British Columbia. There is about a 37 percent chance in the next 50 years of a Magnitude 8+ earthquake originating on the southern portion of the CSZ and up to a 15 percent chance in the next 50 years of a great earthquake affecting the entire Pacific Northwest. The scenario involving rupture of the Northern Oregon portion would significantly impact all Western Oregon, including Newberg.



Figure 2.1 – Six-Step Process to Planning for Community Resilience (NIST, 2015)

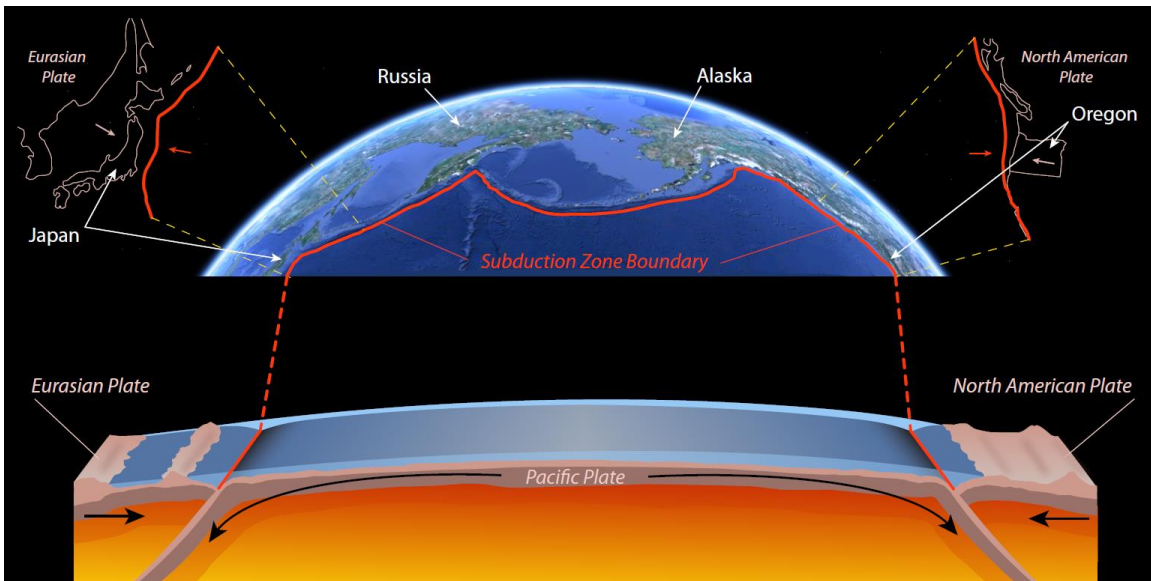


Figure 2.2 – Oregon and Northern Japan Mirror Image Subduction Zones (OSSPAC, 2013)

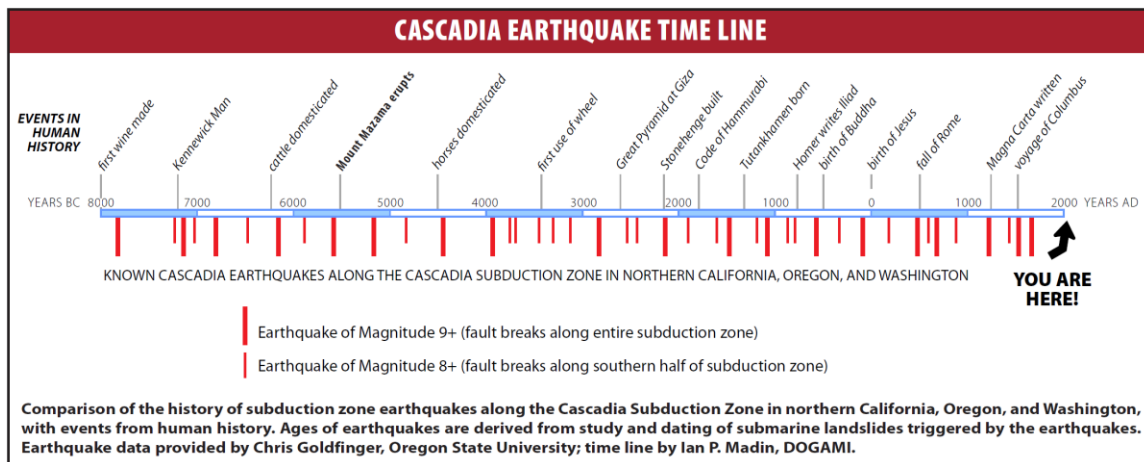


Figure 2.3 – Historic Cascadia Subduction Zone Earthquake Timeline (DOGAMI, 2010)

3.0 Level of Service Goals

Resilience planning involves establishing level of service (LOS) goals to define system performance expectations after being impacted by the hazard under consideration. These LOS goals could be simple, such as maintain service for 100 percent of customers during a routine winter storm that disrupts commercial electrical power for 24 hours, or they may be more complex for more damaging hazards like major earthquakes. This section presents examples of LOS goals included in other plans and then describes the LOS goals suggested for adoption by the City of Newberg for the water system.

3.1 SPUR Resilient City

In one of the first studies of its kind, the San Francisco Planning + Urban Research Association (SPUR) developed a series of policy papers aimed at raising awareness of how San Francisco’s buildings and lifeline infrastructure are likely to perform in an expected earthquake and identifying actions that could be implemented before an earthquake to improve the City’s resilience. The report outlined the importance of how the restoration timeline for water, wastewater, electrical power, and other lifeline systems impacts the speed with which a community can return to normal after a major disruption (SPUR, 2009). The report established the goals of restoring lifeline services to: 1) 90 percent of customers within 72 hours, 2) 95 percent of customers within one month, and 3) 100 percent of customers within four months after an expected level earthquake. It is assumed that critical facilities (e.g., hospitals, emergency operations centers, etc.) would be included in the 90 percent of customers restored within 72 hours. For buildings, the SPUR report defines the expected level earthquake as one having a 10 percent probability of occurring in a 50-year period and compares it to a magnitude 7.2 earthquake on the peninsula segment of the San Andreas Fault. The SPUR report also indicated that for lifeline systems, that typically have a longer design life than buildings, a larger expected level earthquake should be considered.

3.2 Oregon Resilience Plan

The threat of a Cascadia earthquake is a significant enough physical, economic, and social risk in the Pacific Northwest that in 2012 and 2013, at the request of the State of Oregon Legislative Assembly, the Oregon Seismic Safety Policy Advisory Commission (OSSPAC) and a team of volunteer professionals developed the *Oregon Resilience Plan: Reducing Risk and Improving Recovery for the Next Cascadia Earthquake and Tsunami* (OSSPAC, 2013). The *ORP* outlines steps that can be taken over a 50-year period to bring the state closer to resilient performance through a systematic program of vulnerability assessments, capital investments in buildings and infrastructure systems, new incentives to engage the private sector, and policy changes that reflect current understanding of the Cascadia threat to our community and economy.

OSSPAC assembled eight task groups, comprising over 160 volunteer subject-matter experts from government, universities, the private sector, and the general public. Task Groups included: (1) Cascadia earthquake scenario, (2) business and workforce continuity, (3) coastal communities, (4) critical and essential buildings, (5) transportation, (6) energy, (7) information and communications, and (8) water and wastewater. Task Group activities were overseen by OSSPAC and an Advisory Group. Each Task Group was charged to:

- Determine the likely impacts of a Magnitude 9.0 Cascadia earthquake and tsunami on its assigned sector, and estimate the time required to restore functions in that sector if the earthquake were to strike under present conditions;
- Define acceptable timeframes to restore functions after a future Cascadia earthquake to fulfill expected resilient performance; and
- Recommend changes in practice and policies that, if implemented during the next 50 years, will allow Oregon to reach the desired resilience targets.

The various task groups used estimates of the seismic hazard and expected ground motions developed by the Cascadia Earthquake Scenario Task Group in combination with knowledge of the construction era and condition of existing infrastructure to estimate the expected performance and service restoration times if the scenario event were to occur at the time the *ORP* was being developed.

The *ORP* used the SPUR model as a starting point for developing LOS goals (target timelines for restoration of services) after a Cascadia earthquake. These restoration targets were established assuming system resilience enhancements would be implemented over the following 50 years. These targets were set for three levels of service:

- Minimal level of service restored for the use of emergency response;
- Functional level of service up to 50 percent of capacity that is sufficient to get the economy moving again, and an
- Operational level of service where restoration is up to 90 percent of capacity (which may still rely on temporary fixes).

Table 3.1 summarizes the *ORP*'s goals for the restoration of water service for the Willamette Valley (after 50 years of resilience improvements) and compares it to the expected performance if the earthquake were to have occurred at the time the *ORP* was written. The time differences between the *ORP* restoration target (LOS) goal and expected performance illustrates the resilience gaps that require investment in infrastructure improvements, and public policy enhancements over the coming years.

**Table 3.1 – ORP Water System Recovery Goals: Valley Zone
(adapted from OSSPAC 2013)**

	0-24 hours	1-3 days	3-7 days	1-2 weeks	2-4 weeks	1-3 months	3-6 months	6-12 months	1-3 years	3+ years
Potable water available at supply source (WTP, wells, impoundment)	R	Y		G			X			
Main transmission facilities, pipes, pump stations, and reservoirs (backbone) operational	G					X				
Water supply to critical facilities available	Y	G				X				
Water for fire suppression – at key supply points	G		X							
Water for fire suppression – at fire hydrants			R	Y	G			X		
Water available at community distribution centers/points		Y	G	X						
Distribution system operational		R	Y	G				X		

Key to Table

Target Timeframe for Recovery:

- Desired time to restore components to 20-30% operational
- Desired time to restore components to 50-60% operational
- Desired time to restore components to 80-90% operational
- Current state (90% operational)

R
Y
G
X

3.3 NIST Community Resilience Planning Guide

The authors of the NIST *Guide* built upon the framework established by SPUR and the *ORP* in developing recommendations for community resilience planning. The categories, for which restoration timeline goals should be set, were further expanded to consider additional system components and to clarify that restoration timelines will likely vary based on the building cluster that is being supported (critical facilities, emergency housing, housing/neighborhoods, etc.). The *Guide* does not make recommendations for recovery timelines but provides a framework that communities can use to collectively establish these recovery timeline goals. The expanded *Guide* performance goal table

along with the restoration timeline goals established by the *ORP* have been used in developing level of service goals for this project. Further description of the recommended City of Newberg water system level of service goals developed as part of this project is provided in Section 3.8.

3.4 San Francisco Public Utilities Commission

The San Francisco Public Utilities Commission (SFPUC) outlines seismic design requirements in an agency specific engineering standard, *General Seismic Requirements for Design of New Facilities and Upgrade of Existing Facilities* (SFPUC, 2014). The purpose of the Standard is “to set forth consistent criteria for the seismic design and retrofit of San Francisco’s water and wastewater infrastructures. These systems comprise buildings, aboveground and underground piping, retaining walls, underground structures, tanks and basins, dams and reservoirs, special structures, and equipment under the jurisdiction of the SFPUC.”

The SFPUC Standard establishes that the water system basic level of service goal is to deliver winter day demand (WDD) within 24 hours after a major earthquake. For critical and non-redundant structures and components, this major earthquake is defined as having a 5% probability of exceedance in 50 years (975-year return period). The basic level of service goal also considers several supplemental criteria that include (SFPUC, 2014):

- Deliver WDD to at least 70% of SFPUC wholesale customers’ turnouts within each of the three customer groups;
- Achieve a 90% confidence level of meeting the above goal, given the occurrence of a major earthquake;
- To achieve the basic level of service, the SFPUC shall rely on the wholesale customer’s own water systems and supply or other regional water purveyor’s systems. SFPUC will work with customers to assess their ability to contribute to their own system reliability;
- The SFPUC shall consider a facility to have failed if it cannot be brought back to its intended purpose within 24 hours without secondary damage resulting; and
- To achieve the basic level of service, the SFPUC shall assume that power supplies are available, whether from the grid or from standby sources.

The SFPUC shall assume that no significant repairs are performed in the first 24 hours following a major earthquake. Possible operations that might occur during the first 24 hours include valve operations, temporary bypasses, and restoration of minor planned outages, if regional infrastructure remains intact.

3.5 Community Needs Following a Major Earthquake

To support the region’s economic and community recovery after a major disaster, infrastructure services are required to be restored as the building clusters that rely on these services come back online (i.e., a building that will take six months to reopen due to repair of structural damage doesn’t need water service until the end of that six months). In some cases, like that for smaller businesses, an outage of critical services like water for more than a few weeks may mean a business cannot return to a location. The current expectation of many Oregonians is that water service will be restored within one month after a major earthquake (City Club, 2017). The water system recovery goals suggested in the *ORP* are generally consistent with this public expectation. The *ORP* also sets goals for partial recovery in the initial days and weeks after a major earthquake with the aim of supporting rapid economic and social recovery.

Given that it would be cost prohibitive to eliminate all earthquake damage, a fundamental short-term community need will be to provide water for fire suppression and for use by hospitals, emergency shelters, and other similar facilities. Immediately after the event, it is anticipated that the City of Newberg will focus on repairing any damage to the water system supplying these critical customers and then quickly transition to restoring water service to other customers. This goal for rapid restoration of the water service will help support the Newberg Community’s desire that residents will be able to shelter-in-place in their homes immediately after a major earthquake and that they will be able to resume a semi-normal daily routine after two to four weeks by returning to school/work, shopping at their local grocery store, receiving medical care at their local clinic, etc. All these normal activities involve the use of water. At first it is expected that temporary measures will be required to distribute water, but as the weeks progress more permanent fixes will be implemented and the temporary measures will slowly disappear. The City may also be challenged by an influx of people displaced from coastal communities that were severely impacted by the earthquake and associated tsunami. Therefore, the post-disaster emergency water demand could increase to support additional short-term residents.

Table 3.2 provides a breakdown of restoration priorities for City customers that was jointly developed in a collaborative workshop conducted with the HDR team and City of Newberg staff. The table links social/economic needs to restoration timeline goals [short-term (no disruption), short-term (1-3 days), intermediate-term (within 4 weeks), and long-term (months)]. Note that these restoration timeline goals have been established based on our current understanding of the community’s social and economic needs, without consideration or knowledge of the current expected seismic performance of these existing community facilities. In order to support community social and economic needs on a timeline that is similar to that proposed for the water system, many of these community facilities may need to be seismically retrofit or replaced with new buildings designed with a higher structural and nonstructural performance objective. If a facility that is critical to supporting community short- and intermediate-term social/economic needs is relocated, site selection criteria for the new location should consider proximity to

the water system backbone or the water system backbone should be appropriately modified to include the location of the new facility.

Table 3.2 – City of Newberg Social/Economic Recovery Goals

Response/Recovery Phase	Social/Economic Needs
<p align="center">Short-Term (no disruption)</p>	<ul style="list-style-type: none"> • Water Supply Points for Fire Suppression <ul style="list-style-type: none"> ○ North Valley and Corral Creek Reservoirs ○ Newberg High School ○ Chehalem Valley Middle School ○ Edwards and Joan Austin Elementary Schools ○ George Fox University ○ Portland Community College ○ Rogers Landing (drafting from Willamette River) • Providence Newberg Medical Center
<p align="center">Short-Term (1-3 days)</p>	<ul style="list-style-type: none"> • Newberg Public Safety Building (Police Station, City EOC) • Fire stations <ul style="list-style-type: none"> ○ TVF&R Station #20 and #21 • Community Water Distribution Points <ul style="list-style-type: none"> ○ Calvary Chapel Newberg ○ Chehalem Glenn Golf Course ○ Church of Jesus Christ of Latter-Day Saints ○ Family Life Church ○ First Presbyterian Church ○ Grace Baptist Church ○ George Fox University ○ Newberg Christian Church ○ Newberg Friends Church ○ Northside Community Church ○ River Street Church of God ○ Seventh Day Adventists ○ Zion Lutheran Church • Urgent Care Centers <ul style="list-style-type: none"> ○ Newberg Urgent Care ○ Providence Express Care • Dialysis Center (Fresenius Kidney Care) • Emergency shelters <ul style="list-style-type: none"> ○ Newberg High School ○ Chehalem Valley and Mountain View Middle Schools ○ Edwards Elementary School ○ George Fox University (locations TBD) • Senior Care Facilities <ul style="list-style-type: none"> ○ Arbor Oaks Terrace ○ Astor House at Springbrook ○ Avamere Newberg ○ Brookdale Newberg ○ Friendsview Retirement Community ○ Friendsview Springbrook Meadows ○ Marquis Newberg ○ Willow Place

Table 3.2 – City of Newberg Social/Economic Recovery Goals (cont.)

Response/Recovery Phase	Social/Economic Needs
<p>Short-Term (cont.) (1-3 days)</p>	<ul style="list-style-type: none"> • Sportsman Airpark (supplied by Sam Whitney Water District) • Wastewater Treatment Plant (pump seal water) • Public Works Department buildings • Newberg School District Office
<p>Intermediate-Term (within 4 weeks)</p>	<ul style="list-style-type: none"> • Water District Customers <ul style="list-style-type: none"> ○ Chehalem Terrace ○ Chehalem Valley ○ NW Newberg ○ Sunny Acres ○ West Sheridan • City of Newberg facilities • Remaining Newberg School District facilities • Medical office buildings • 90% of customer connections • 90% of fire hydrants
<p>Long-Term (months)</p>	<ul style="list-style-type: none"> • Remaining 10% of customer connections • Remaining 10% of fire hydrants

3.6 Water Supply Points for Fire Suppression

Table 3.2 and Figure 3.1 identify the potential location of nine key supply points distributed throughout the city where tanker trucks could obtain water for fire suppression if the hydrant system is down following a major earthquake. At the two reservoir sites, it may be necessary to install seismic shutoff valves to preserve water storage, install segments of hardened pipe, and upgrade roadway access to the reservoirs. At the fire water distribution points within the city, it is anticipated that hydrants will be installed that are connected to the hardened backbone system and are designed to accommodate any expected permanent ground deformation. The Rogers Landing Boat Launch is proposed as an alternative site where fire trucks could draft water from the Willamette River.

3.7 Community Water Distribution Points

Table 3.2 and Figure 3.2 identify the potential location of 12 community water distribution points throughout the city where city residents could obtain potable water following a major earthquake. The City of Newberg Public Works Department is working with faith-based organizations to provide the manpower necessary to operate these water distribution sites. At the community water distribution points, it is recommended that hydrants be installed that are connected to the hardened backbone system and are designed to accommodate any expected permanent ground deformation.

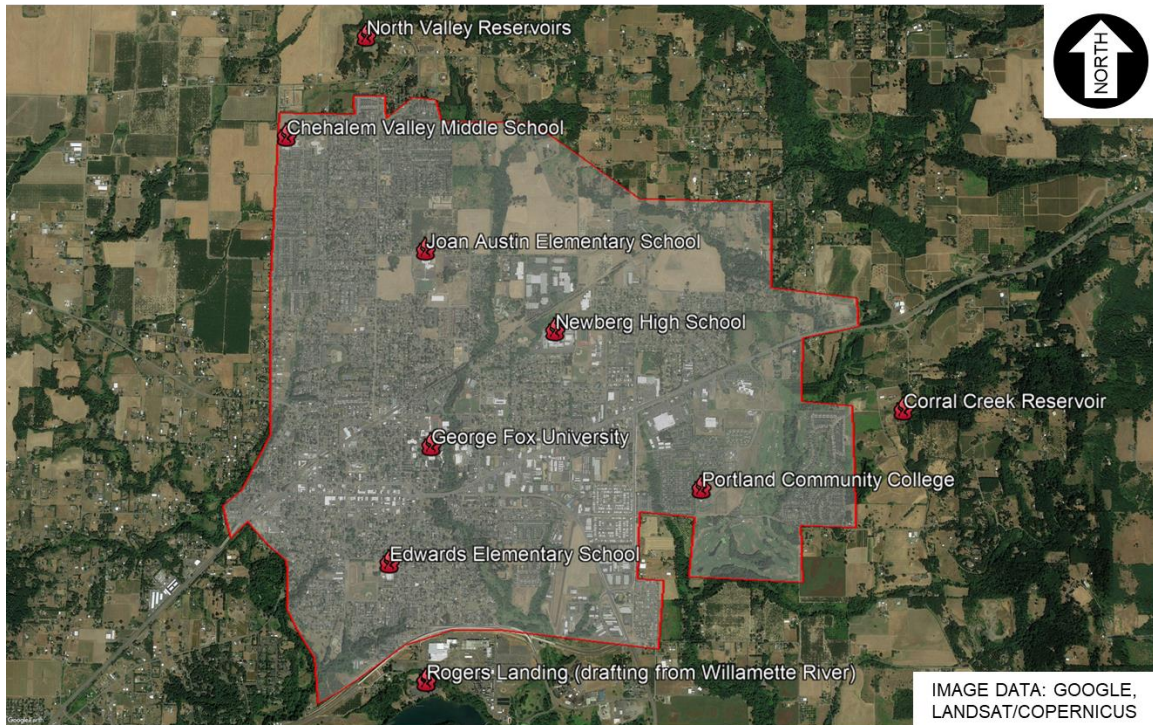


Figure 3.1 – Potential Water Supply Points for Fire Suppression

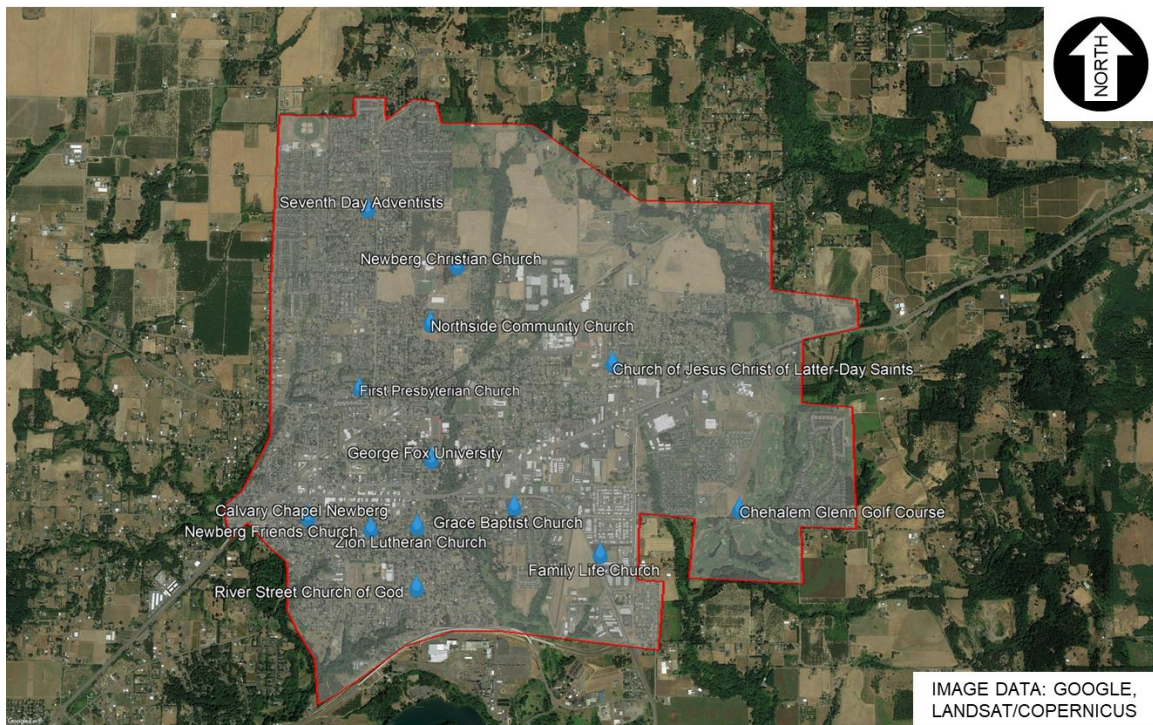


Figure 3.2 – Potential Community Water Distribution Points

3.8 City of Newberg Water System Level of Service Goals

The *ORP* was developed assuming a three-tiered LOS goal approach to implement a phased restoration of services and help define the speed of recovery for a community’s infrastructure systems. The *ORP* recommended a timeline for these three-tiered LOS goals but provided the flexibility for an individual utility to define how the levels of functional restoration are to be achieved for their specific system. The LOS (i.e., restoration timeline) goals proposed for adoption by the City of Newberg align with those presented in the *ORP* and are augmented by additional considerations suggested by the *NIST Guide*. Table 3.3 summarizes these goals for the City of Newberg water system broken down in terms of specific goals for source, transmission, control systems, and distribution. All goals are based on providing water meeting minimum regulatory requirements, although a boil water notice may be in effect due to damage throughout the distribution system. Table 3.3 provides additional information about the recommended definition of 30%, 60%, and 90% operational for City of Newberg water system infrastructure. For example, the 90% operational goal for hospital facilities has been defined to mean that the City of Newberg water system is capable of delivering 90% of their average winter day demand of water meeting minimum regulatory requirements to hospital facilities within the City of Newberg service area.

**Table 3.3 – City of Newberg Water System Recovery Goals
(adapted from OSSPAC 2013 and NIST 2015)**

Water Systems	Target Timeframe for Recovery							
	Phase 1: Short-Term			Phase 2: Intermediate			Phase 3: Long-Term	
	Days			Weeks			Months	
	0-1	1-3	3-7	1-2	2-4	4-12	3-6	6-12
Source								
Raw or source water and terminal reservoirs	30% AWDD ^a	60% AWDD		90% AWDD				
Raw water conveyance (pump stations and piping to WTP)	30% AWDD	60% AWDD		90% AWDD				
Water Production	30% AWDD	60% AWDD		90% AWDD				
Well and/or Treatment operations functional	30% AWDD	60% AWDD		90% AWDD				
Transmission								
Backbone transmission facilities (pipelines, pump station, and tanks)	90% AWDD							
Water for fire suppression at key supply points (to promote redundancy)	90% of required fire flow and duration available							
Control Systems								
SCADA and other control systems	90% of components required for normal operation are functional							
Distribution								
Critical Facilities								
Hospitals	90% of AWDD							
EOC, Police Stations, Fire Stations, Public Works Buildings	60% of AWDD	90% AWDD						
Emergency Housing								
Emergency Shelters	60% of emergency water for drinking/sanitation	90% of emergency water for drinking/sanitation						
Housing/Neighborhoods								
Potable water available at community distribution centers		60% of emergency water for drinking/sanitation	90% of emergency water for drinking/sanitation					
Water for fire suppression at fire hydrants			30% of hydrants restored	60% of hydrants restored	90% of hydrants restored			
Community Recovery Infrastructure								
All other clusters			30% of customer connections restored	60% of customer connections restored	90% of customer connections restored			

^a AWDD = Average Winter Day Demand

Key to Table

Desired time to restore components to 30% operational R
 Desired time to restore components to 60% operational Y
 Desired time to restore components to 90% operational G

4.0 City of Newberg Backbone System Supporting Short-Term Community Needs

Satisfying short-term LOS restoration timeline goals requires critical components of the water production, treatment, transmission, and distribution system to remain operational or experience only minor damage after a major earthquake. These critical system components usually include: small diameter distribution pipelines and associated reservoirs/pump stations that connect to critical and essential facilities (hospitals, emergency shelters, etc.), large diameter transmission pipelines and associated pump stations, treatment plant structures, and certain support facilities (laboratories, maintenance shops, etc.). If an assessment of these critical system components reveals any gaps between the expected performance and that required to achieve the LOS goals, then these deficient components should be seismically retrofit or replaced, as appropriate.

The HDR team has collaborated with the City of Newberg to identify the proposed backbone for the City water system shown in Figure 4.1. The backbone system provides water distribution system connections between the well field, raw water transmission pipelines, water treatment plant, finished water reservoirs, and distribution system pipelines that serve facilities that are required to meet short-term community needs (see Table 3.2). The backbone systems proposed for the City of Newberg water system is consistent with that envisioned during the development of the *ORP*. The backbone includes elements of the water system that are required to meet short-term LOS restoration timeframe goals in the initial days after a major earthquake. Since it would be challenging to implement any significant repairs to the backbone system in the initial days after an earthquake, the elements of the backbone system should be designed or retrofit such that they experience only minor or no geotechnical, structural, and nonstructural related damage during a major earthquake.

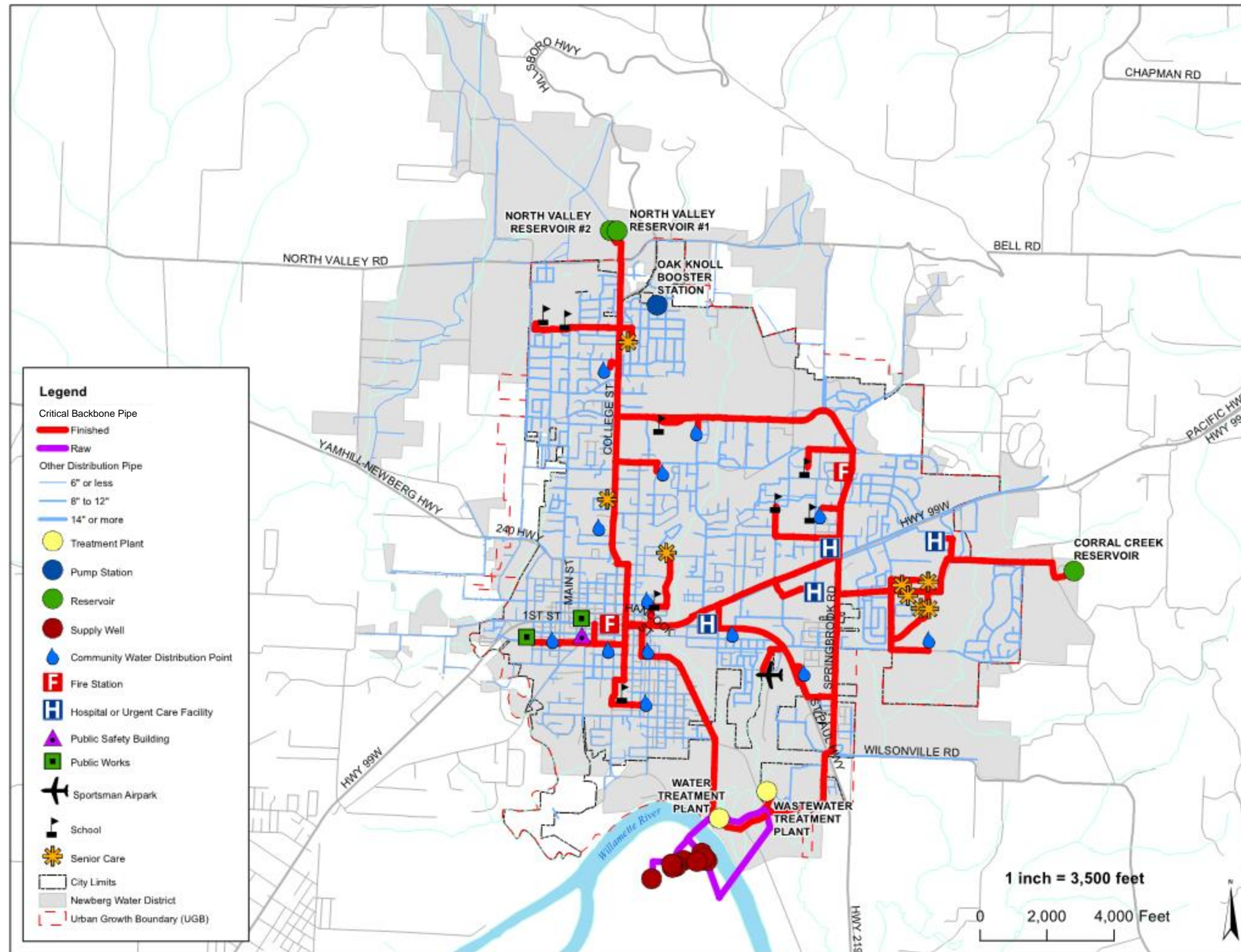


Figure 4.1 – City of Newberg Water System Backbone

5.0 Translation of Level of Service Goals into System Performance Requirements

Several factors need to be taken into consideration when translating the City of Newberg LOS goals into performance requirements for the seismic design or retrofit of water system components. Section 5.1 describes several of the factors that have been considered in developing the recommended general performance requirements detailed in Section 5.2.

5.1 Considerations

The following subsections describe factors considered in developing performance requirements for the various components of the City of Newberg water system. For future water system projects, these factors should also be evaluated on a project-specific basis to determine if there are any unique features of the project that require modification of the general seismic resilience-based performance requirements.

5.1.1 Geotechnical Hazards

Observations from past earthquakes have indicated that geotechnical hazards are a major contributing factor to the expected post-earthquake performance of water systems. Infrastructure that is exposed to liquefaction, lateral spreading, or landslide geotechnical hazards requires special design considerations that include either mitigation measures to address the geotechnical hazard or predetermined work-arounds to bypass components that may fail during an earthquake. Water treatment plants can be particularly vulnerable to damage from earthquake-induced liquefaction and lateral spreading because these facilities are often constructed in low-lying areas near water sources. These areas correspond with those at high risk for liquefaction and lateral spreading. Transmission and distribution piping that crosses creeks or other low-lying areas are also particularly vulnerable to damage from earthquake-induced liquefaction and lateral spreading.

5.1.2 Effects of Aftershocks

Major earthquakes are often accompanied by numerous aftershocks. In the 2011 Tohoku Japan earthquake two major aftershocks caused additional damage to infrastructure systems, resulting in relapses in the number of customer outages (Nojima, 2012). It may be necessary to reevaluate system components or perform additional repairs after major aftershocks.

5.1.3 Repair Difficulty

Certain water system components (like large diameter transmission mains) may be very difficult to repair after an earthquake. If a component is anticipated to be difficult to repair and it is also important to system performance, then it should be designed to minimize any potential earthquake damage that would impact the functionality of the component. Other assets of this type could include pipes under railroad tracks or highways.

5.1.4 Availability of Public Works Department Staff

The first priority for many City of Newberg Public Works Department staff in the initial hours and days following a major earthquake will be to ensure the health and safety of their families. Once those critical needs are addressed, City of Newberg Public Works Department staff will, ideally, be available to report to work. However, even after they return to work, it is possible that the City Emergency Manager may assign Public Works Department staff to work on non-water system related tasks that are deemed more critical to the City's disaster response activities. This scenario suggests that Public Works Department staff may have limited ability to perform repairs or implement predetermined work-arounds in the initial hours and days after an earthquake. Critical components of the water system that are required to be operational within the first 3-7 days after an earthquake should be designed or seismically retrofitted to remain operational during and immediately after a major earthquake.

5.1.5 Availability of Design Professionals and Contractors

The restoration timeline goals and required repairs must be in line with the anticipated availability of qualified design professionals and contractors to design and implement the repairs. It is anticipated that the design and construction of major repairs to a pump station or treatment plant structure would take between 6-12 months. It is anticipated that the design and construction that replaces a pump station or treatment plant structure would take a minimum of 18 months. These timeframes may increase if the City decides to rebuild the pump stations to a higher standard of performance, i.e., a resilient design, which may require more planning and design time.

5.1.6 Availability of Repair Materials or Replacement Equipment

The City of Newberg maintains limited supplies of emergency repair materials, but these supplies are not anticipated to be adequate for the number of repairs that may be necessary after a major earthquake. For disasters that impact a relatively small geographic region, it is possible that other nearby utilities could lend repair supplies. However, a CSZ earthquake will impact the entire Pacific Northwest (from Northern California to British Columbia) and relying on neighboring utilities as a potential source for repair materials is likely impractical.

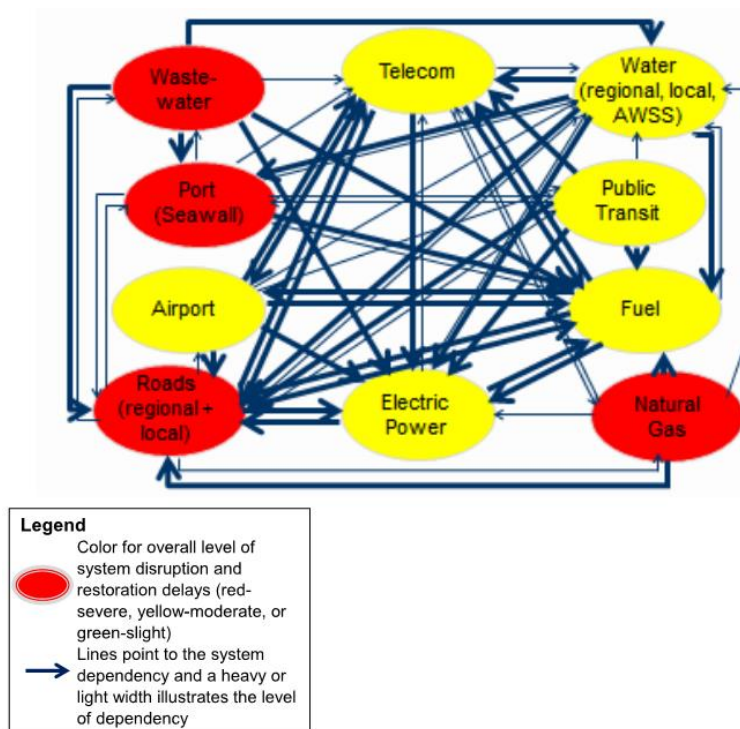
Additionally, some equipment used in pump stations and treatment plants is not available from manufacturer's stock and has a long lead time for production. Special consideration must be given to this difficult-to-source equipment to ensure that it is either not damaged during an earthquake, a predetermined work-around has been established, or the equipment manufacturing lead time aligns with restoration timeline goals.

5.1.7 Infrastructure Dependencies

The restoration of water system infrastructure is highly dependent on other infrastructure systems. Examples of these dependencies include:

- Co-location with and damage to other lifeline systems (roads, bridges, wastewater pipes, etc.);
- Liquid fuel availability for trucks, generators, and equipment;
- Commercial electrical power;
- Transportation system for delivery of repair materials and mutual aid assistance crews; and
- Cellular communications system for coordination of City of Newberg staff and contractors.

The level of service goals and performance requirements suggested in this report assume that all lifeline service providers will be making significant investments in the earthquake resilience of their systems in the next 45 years. If one or more lifeline sectors do not make these system improvements, then the speed of community recovery could be greatly impacted because of the dependencies between all infrastructure systems. Figure 5.1 shows an example of the complicated dependency relationships among lifelines in the San Francisco Bay Area (City and County of San Francisco Lifelines Council, 2014). Heavy and light lines widths depict the relative level of dependencies anticipated to occur between the various lifelines systems following a scenario M7.9 earthquake on the San Andreas fault.



**Figure 5.1 – Lifeline Interdependencies in the San Francisco Bay Area
(City and County of San Francisco Lifelines Council, 2014)**

5.2 Water System Structures

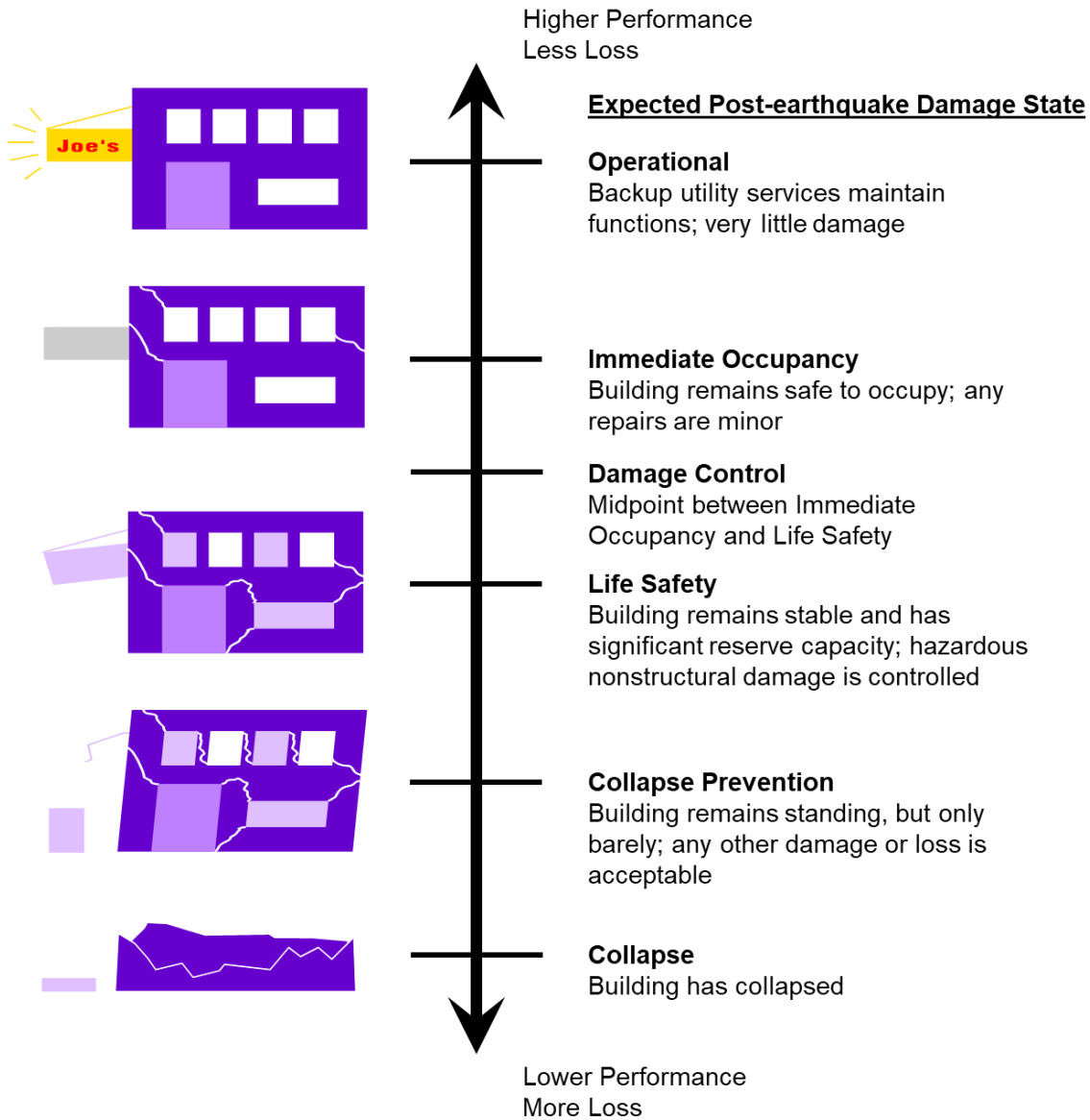
Water system structures (reservoirs, pump stations, etc.) required to maintain water pressure for fire suppression are designated as Risk Category IV structures and water system structures not required to maintain water pressure for fire suppression are designated as Risk Category III structures according to the requirements of the latest edition of the *Oregon Structural Specialty Code* (OSSC, 2014). For new structures, the construction cost increase associated with elevating the design standard from Risk Category III to Risk Category IV is typically relatively minor. Therefore, it is recommended that all new water system structures should be designed per the more stringent *Oregon Structural Specialty Code* seismic design requirements for Risk Category IV structures. Also, since geotechnical hazards (e.g., liquefaction and lateral spreading, etc.) can significantly impact the performance of water system structures following a major earthquake, it is recommended that site-specific geotechnical investigations and analysis be conducted to characterize these potential hazards. Water system structure designs should include appropriate measures to mitigate these potential site-specific geotechnical hazards. Equipment associated with water system structures should be adequately braced and seismically certified, per the requirements of the latest edition of *ASCE 7, Minimum Design Loads for Buildings and Other Structures* (ASCE, 2017a), so that it could remain operational after a design level earthquake, as long as dependent systems are also functional [e.g., electrical power (emergency generator or commercial), etc.]. Piping entering or exiting water system structures should be designed to accommodate the anticipated earthquake-induced relative movement between the structure and surrounding soil.

In order to meet the target LOS goals, water system structures need to meet or exceed defined levels of structural and nonstructural seismic performance. ASCE 41-17, *Seismic Evaluation and Retrofit of Existing Buildings* (ASCE, 2017b), presents several structural and nonstructural seismic performance objectives and describes the expected level of earthquake damage associated with each performance objective. Also included are expectations about the operability and reparability of earthquake damage for these various performance objectives. The ASCE 41-17 descriptions of these performance objectives are provided below and summarized in Figure 5.2. Table 5.1 provides a comparison between these performance objectives and the intended performance associated with *Oregon Structural Specialty Code* Risk Categories.

Table 5.1 – Comparison of Seismic Performance Objectives with OSSC Risk Categories

Risk Category	Performance Objective ^a	
	Structural	Nonstructural
IV	Immediate Occupancy	Operational
III	Damage Control	Position Retention
I & II	Life Safety	Position Retention

^a For the BSE-1N seismic hazard level as defined by ASCE 41-17



**Figure 5.2 – Building Performance Objectives
 (adapted from ASCE, 2017b)**

Structural Performance Objectives

Immediate Occupancy: “Immediate Occupancy” refers to the post-earthquake damage state in which only very limited structural damage has occurred. The basic vertical- and lateral-force-resisting systems of the building retain almost all their pre-earthquake strength and stiffness. The risk of life-threatening injury from structural damage is very low, and although some minor structural repairs might be appropriate, these repairs would generally not be required before re-occupancy. Continued use of the building is not limited by its structural condition but might be limited by damage or disruption to nonstructural elements of the building, furnishings, or equipment and availability of external utility services.

Damage Control: “Damage Control” refers to a midway point between Life Safety (see next description) and Immediate Occupancy (see previous description). This performance objective is intended to provide a structure with a greater reliability of resisting collapse and being less damaged than a typical structure, but not to the extent required of a structure designed to meet the Immediate Occupancy Performance Level. Although this level is a numerically intermediate level between Life Safety and Immediate Occupancy, the two performance objectives are essentially different from each other. The primary consideration for Immediate Occupancy is that the damage is limited in such a manner as to permit reoccupation of the building, with limited repair work occurring while the building is occupied. The primary consideration for Life Safety is that a margin of safety against collapse be maintained and that consideration for occupants to return to the building is a secondary impact to the Life Safety objective being achieved. The Damage Control Performance Level provides for a greater margin of safety against collapse than the Life Safety Performance Level would. The level might control damage in such a manner as to permit return to function more quickly than the Life Safety Performance Level, but not as quickly as the Immediate Occupancy Performance Level does.

Life Safety: “Life Safety” refers to the post-earthquake damage state in which significant damage to the structure has occurred but some margin against either partial or total structural collapse remains. Some structural elements and components are severely damaged, but this damage has not resulted in large falling debris hazards, either inside or outside the building. Injuries might occur during the earthquake; however, the overall risk of life-threatening injury from structural damage is expected to be low. It should be possible to repair the structure; however, for economic reasons, this repair might not be practical. Although the damaged structure is not an imminent collapse risk, it would be prudent to implement structural repairs or install temporary bracing before re-occupancy.

Nonstructural Performance Objectives

Operational: “Operational” refers to the performance level where most nonstructural systems required for normal use of the building are functional, although minor cleanup and repair of some items might be required. Achieving the Operational nonstructural performance level requires considerations of many elements beyond those that are normally within the sole province of the structural engineer’s responsibilities. For Operational nonstructural performance, in addition to ensuring that nonstructural components are properly mounted and braced within the structure, it is often necessary to provide emergency standby equipment to provide utility services from external sources that might be disrupted. It might also be necessary to perform qualification testing to ensure that all necessary equipment will function during or after strong shaking.

Position Retention: “Position Retention” refers to the nonstructural condition of a building after an event where, presuming that the building is structurally safe, occupants can occupy the building safely, with some limitations: normal use might be impaired, some cleanup might be needed, and some inspection might be warranted. In general, building equipment is secured in place and might be able to function if the necessary utility service is available. However, some components might experience misalignments or internal damage and be inoperable. Power, water, natural gas, communications lines, and other utilities required for normal building use might not be available. Cladding, glazing, ceilings, and partitions might be damaged but would not present safety hazards or un-occupiable conditions. For this performance level, the risk of life-threatening injury caused by nonstructural damage is very low.

Detailed geotechnical and structural seismic evaluations should be conducted for existing water system structures to determine if their anticipated seismic performance will enable LOS goals to be achieved. To satisfy the target water system restoration timeline, structures that must be operational soon after a major earthquake should be evaluated and if required, seismically retrofit to a more stringent structural and nonstructural performance level than those that are not required until later in the recovery phase. Table 5.2 provides the seismic retrofit criteria proposed for adoption by the City of Newberg for water system infrastructure in terms of the structural and nonstructural performance objectives presented in ASCE 41. These performance objectives are for the Basic Safety Earthquake-1 for use with the Basic Performance Objective Equivalent to New Building Standards (BSE-1N). This BSE-1N seismic hazard level is consistent with that used to design new structures per the *Oregon Structural Specialty Code*. Note that the proposed LOS goals require that the water system has essentially been restored to a 90% operational level within 2-4 weeks after a M9.0 CSZ earthquake. This would suggest that the majority of system components are capable of achieving Immediate Occupancy structural performance and Operational nonstructural performance. Table 5.2 also includes alternative (less stringent) retrofit performance objectives for system components that might not be required to be returned to service until 1-6 months or 6-12 months after the earthquake. For example, the City of Newberg may decide that one of

the reservoirs is not required to achieve short- and intermediate-term LOS goals and may elect to relax the restoration timeline goals for that particular water system structure.

Table 5.2 – Water System Seismic Retrofit Performance Objectives

Restoration Timeline	Retrofit Performance Objective ^a	
	Structural	Nonstructural
0-1 months	Immediate Occupancy	Operational
1-6 months	Immediate Occupancy	Position Retention ^b
6-12 months	Damage Control ^c	Position Retention ^b

^a For the BSE-1N seismic hazard level as defined by ASCE 41-17.

^b Assumes lead time for delivery and installation of damaged equipment falls within restoration timeline goals, otherwise equipment should be seismically certified per the requirements of the latest edition of ASCE 7.

^c Assumes that the structural damage can be repaired within restoration timeline goals. For earthquake damage that may be especially difficult to repair within the target timeline, structure should be retrofitted to satisfy the Immediate Occupancy performance objective.

6.0 Limitations

The opinions and recommendations presented in this report were developed with the care commonly used as the state of practice of the profession. No other warranties are included, either expressed or implied, as to the professional advice included in this report. This report has been prepared for the City of Newberg to be used solely in its evaluation of the seismic safety of the water system referenced. This report has not been prepared for use by other parties and may not contain sufficient information for purposes of other parties or uses.

References

- ASCE. (2017a) ASCE 7-16, *Minimum Design Loads for Buildings and Other Structures*, American Society of Civil Engineers, Reston, VA.
- ASCE. (2017b). ASCE 41-17, *Seismic Evaluation and Retrofit of Existing Buildings*, American Society of Civil Engineers, Reston, VA.
- City and County of San Francisco Lifelines Council. (2014) *Lifelines Interdependency Study I Report*, San Francisco, CA.
- City Club. (2017) *Big Steps Before the Big One: How the Portland area can bounce back after a major earthquake*, City Club of Portland, Portland, OR.
- DOGAMI. (2010) *Cascadia*, Winter 2010, Department of Geology and Mineral Industries, Salem, OR.
- FEMA. (2015) *National Preparedness Goal*, Federal Emergency Management Agency, Washington D.C.
- NIST. (2015) *Community Resilience Planning Guide for Building and Infrastructure Systems*, NIST Special Publication 1190, National Institute of Standards and Technology, Gaithersburg, MD.
- Nojima, N. (2012) Restorations and System Interactions of Lifelines in the Great East Japan Earthquake Disaster, 2011, *Proceedings of the International Symposium on Engineering Lessons Learned from the 2011 Great East Japan Earthquake*, Tokyo, Japan
- OSSC. (2014) *Oregon Structural Specialty Code*, International Code Council, Country Club Hills, IL.
- OSSPAC. (2013) *The Oregon Resilience Plan, Reducing Risk and Improving Recovery for the Next Cascadia Earthquake and Tsunami*, Oregon Seismic Safety Policy Advisory Commission, Salem, OR.
- SFPUC. (2014) *General Seismic Requirements for Design of New Facilities and Upgrade of Existing Facilities*, San Francisco Public Utilities Commission, San Francisco, CA.
- SPUR. (2009) *Lifelines: Upgrading Infrastructure to Enhance San Francisco's Earthquake Resilience*, San Francisco Planning + Urban Research Association, San Francisco, CA.



Appendix B: Geotechnical Engineering Report

SUBMITTED TO:
HDR, Engineering Inc.
1001 SW 5th Avenue,
Suite 1800
Portland, Oregon 97204

BY:
Shannon & Wilson, Inc.
3990 Collins Way, Suite 100
Lake Oswego, OR 97035

(503) 210-4750
www.shannonwilson.com

GEOTECHNICAL ENGINEERING REPORT
City of Newberg Water System
Seismic Resilience Study
NEWBERG, OREGON

PAGE INTENTIONALLY LEFT BLANK FOR DOUBLE-SIDED PRINTING

Submitted To: HDR, Engineering Inc.
1001 SW 5th Avenue,
Suite 1800
Portland, Oregon 97204
Attn: Joe Miller

Subject: GEOTECHNICAL ENGINEERING REPORT, CITY OF NEWBERG WATER
SYSTEM SEISMIC RESILIENCE STUDY, NEWBERG, OREGON

Shannon & Wilson prepared this report and participated in this project as a subconsultant to HDR Engineering, Inc. (HDR). Our scope of services was specified in the Geotechnical Subconsultant Agreement dated April 29, 2019. This report presents results of our geotechnical seismic hazard assessment for the City of Newberg's (the City) water system and service area for use in assessing the vulnerability of the City's critical infrastructure. The assessment was performed utilizing Geographic Information System (GIS) data and is based on the magnitude 9.0 Cascadia Subduction Zone (CSZ) scenario defined in the Oregon Resilience Plan (OSSPAC, 2013). Along with evaluating the seismic hazard within the City, we were also tasked with evaluating the seismic hazard and slope stability at the Water Treatment Plant (WTP).

We appreciate the opportunity to be of service to you on this project. If you have questions concerning this report, or we may be of further service, please contact us.

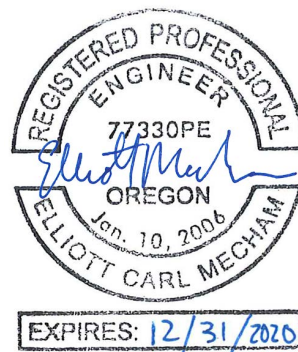
Sincerely,

SHANNON & WILSON, INC.

David Jacobson, GIT
Staff Geologist

Kevin Wood, PE
Senior Engineer

KJW:DSJ:WJP:ECM/cec



Elliott Mecham, PE
Associate | Engineer

CONTENTS

CONTENTS

1 SCOPE OF SERVICES1

2 SEISMIC HAZARD MAPPING1

 2.1 Approach.....1

 2.2 Existing Information Review2

 2.2.1 Regional Seismological Setting.....2

 2.2.2 Oregon Resilience Plan.....3

 2.2.3 Geology.....3

 2.2.4 Available Mapping.....5

 2.3 Modifications to Published Geologic Mapping6

 2.4 Seismic Hazard Maps6

 2.5 Shear Wave Velocity, Vs307

 2.6 Liquefaction Hazard7

 2.7 Landslide Susceptibility8

 2.8 PGA, SA1, SA0.3, and PGV.....8

 2.9 Probability of Liquefaction8

 2.10 Liquefaction-Induced PGD.....9

 2.10.1 Lateral Spreading9

 2.10.2 Settlement.....9

 2.11 Probability of Earthquake-Induced Landslides9

 2.12 Earthquake-Induced Landslide PGD9

 2.13 Seismic Hazards at Critical Infrastructure.....10

3 WATER TREATMENT PLANT SLOPE EVALUATION10

 3.1 Background10

 3.2 Subsurface Conditions.....11

 3.3 Groundwater.....11

 3.4 Seismic and Geologic Hazards.....11

 3.5 Strong Ground Motion.....12

 3.6 Liquefaction12

 3.7 Liquefaction Analysis and Liquefaction-Induced Settlement13

 3.8 Lateral Spreading13

3.9 Slope Stability14

 3.9.1 Approach14

 3.9.2 Static15

 3.9.3 Seismic15

 3.9.4 Post-Seismic.....15

 3.9.5 Results of the Slope Stability Analysis15

4 LIMITATIONS.....16

5 REFERENCES17

Exhibits

Exhibit 1: Site-Adjusted Peak Ground Acceleration12

Exhibit 2: Summary of Liquefaction-Induced Settlement13

Exhibit 3: Summary of Slope Stability Results.....15

Tables

Table 1: Seismic Hazards Mapped at Selected Infrastructure Locations

Figures

Figure 1: Geologic Map

Figure 2: Shear Wave Velocity, Vs30

Figure 3: Liquefaction Hazard

Figure 4: Landslide Susceptibility (Dry Conditions)

Figure 5: Landslide Susceptibility (Wet Conditions)

Figure 6: Peak Ground Acceleration, PGA

Figure 7: 0.3-Second Spectral Acceleration, SA0.3

Figure 8: 1-Second Spectral Acceleration, SA1

Figure 9: Peak Ground Velocity, PGV

Figure 10: Probability of Liquefaction

Figure 11: Liquefaction-Induced Lateral Spreading Permanent Ground Deformation, PGD

Figure 12: Liquefaction-Induced Settlement Permanent Ground Deformation, PGD

Figure 13: Probability of Earthquake-Induced Landslides (Dry)

Figure 14: Probability of Earthquake-Induced Landslides (Wet)

Figure 15: Earthquake-Induced Landslide Permanent Ground Deformation, PGD (Dry)

Figure 16: Earthquake-Induced Landslide Permanent Ground Deformation, PGD (Wet)

Figure 17: Water Treatment Plant Vicinity Map

Figure 18: Water Treatment Plant Slope Site and Exploration Plan

Appendices

Appendix A: Field Explorations

Appendix B: Slope Stability Summary Results

Important Information

CONTENTS

1 SCOPE OF SERVICES

The purposes of the HDR team's seismic hazard assessment are to define water system level-of-service goals, assess the existing system with respect to the levels of service, and develop recommended mitigation measures to address deficiencies. Shannon & Wilson's task is to prepare and provide GIS maps of:

- probability of liquefaction
- probability of earthquake-induced landslides
- liquefaction-induced permanent ground deformation
- earthquake-induced-landslide permanent ground deformations

To achieve these purposes, our scope of services included the following:

- Review existing geologic and geotechnical information;
- Develop seismic ground motion, seismic hazard, and permanent ground deformation hazard maps;
- Perform one boring at the WTP;
- Evaluate liquefaction potential and liquefaction-induced settlement at the WTP;
- Evaluate potential for slope failure for static, seismic, and post-seismic (liquefied) conditions using a limit equilibrium analyses and Slope-W software at the WTP;
- Evaluate seismically induced ground movement using Newmark-type analyses at the WTP;
- Evaluate potential for lateral spread using empirical methods at the WTP, and;
- Summarize the geotechnical evaluations at the WTP and provide maps for the seismic hazard assessment in a Technical Memorandum.

To support the team's structural vulnerability assessment, we also included maps of peak ground acceleration, 0.3- and 1-second spectral accelerations, peak ground velocity, and liquefaction-induced settlement in addition to the maps listed above.

2 SEISMIC HAZARD MAPPING

2.1 Approach

The GIS map layers developed for this project are primarily based on published geologic maps; variations from actual site conditions should be expected. Also, the analyses,

methods and approaches applied herein were developed and used by the Oregon Department of Geology and Mineral Industries (DOGAMI) and the Federal Emergency Management Agency (FEMA) for planning purposes only. They are not the same as those used for site-specific, code-based geotechnical design.

2.2 Existing Information Review

2.2.1 Regional Seismological Setting

Earthquakes in the Pacific Northwest occur largely as a result of the subduction of the Juan de Fuca plate beneath the North American plate along the Cascadia Subduction Zone (CSZ). The CSZ is located approximately parallel to the coastline from northern California to southern British Columbia. The compressional forces that exist between these two colliding plates cause the oceanic Juan de Fuca plate to descend, or subduct, beneath the continental plate at a rate of about 1.5 inches per year. This process leads to volcanism in the North American plate and stresses and faulting in both plates throughout much of the western regions of southern British Columbia, Washington, Oregon, and northern California. Stress between the colliding plates is periodically relieved through great earthquakes at the CSZ plate interface.

Within the regional tectonic framework and historical seismicity, three broad earthquake sources are identified:

- **Subduction Zone Interface Earthquakes** originate along the CSZ, which is located 25 miles beneath the coastline. Paleoseismic evidence and historic tsunami records from Japan indicate that the most recent subduction zone interface event was in 1700 AD and was an approximately magnitude 9 earthquake that likely ruptured the full length of the CSZ.
- **Deep-Focus, Intraplate Earthquakes** originate from within the subducting Juan de Fuca oceanic plate as a result of the downward bending and tension in the subducted plate. These earthquakes typically occur 28 to 38 miles beneath the surface. Such events on the CSZ are estimated to be as large as magnitude 7.5. Historic earthquakes include the 1949 magnitude 7.1 Olympia earthquake, the 1965 magnitude 6.5 earthquake between Tacoma and Seattle, and the magnitude 6.8 2001 Nisqually earthquake. The highest rate of CSZ intraslab activity is beneath the Puget Sound area, with much lower rates observed beneath western Oregon.
- **Shallow-Focus Crustal Earthquakes** are typically located within the upper 12 miles of the earth's surface. The relative plate movements along the CSZ cause not only east-west compressive strain but dextral shear, clockwise rotation, and north-south compression of the leading edge of the North American Plate (Wells and others, 1998), which is the cause of much of the shallow crustal seismicity of engineering significance in the region. The largest known crustal earthquake in the Pacific Northwest is the 1872

North Cascades earthquake with an estimated magnitude of about 7. Other examples include the 1993 magnitude 5.6 Scotts Mill earthquake and magnitudes 5.9 and 6.0 Klamath Falls earthquakes.

2.2.2 Oregon Resilience Plan

The Oregon Resilience Plan is a result of Oregon House Resolution 3, adopted in April 2011. The House Resolution directed the Oregon Seismic Safety Policy Advisory Commission “to lead and coordinate preparation of an Oregon Resilience Plan that reviews policy options, summarizes relevant reports and studies by state agencies, and makes recommendations on policy direction to protect lives and keep commerce flowing during and after a Cascadia earthquake and tsunami” (OSSPAC, 2013). A task group then developed a Cascadia Earthquake Scenario for use by other work groups as a basis for assessing the effects of the scenario on various sectors of society or parts of the built environment.

This assessment is for a magnitude 9.0 CSZ earthquake, as defined in the Oregon Resilience Plan. Other magnitudes of CSZ events and earthquakes from other sources are not considered.

2.2.3 Geology

The City of Newberg is located in the Willamette Valley physiographic province (Orr and others, 1992). The local geology has been mapped by numerous authors, including Schlicker and Deacon (1967), Frank and Collins (1978), Burns and others (1997), O’Connor and others (2001), and Wells and others (2018). A simplified geologic map of the City is presented in Figure 1 and is based on DOGAMI publications OGDC-6 (Smith and Row, 2015) and SLIDO 3.4 (Burns and Watzig, 2017).

Published mapping suggests that the city is underlain at depth by oceanic sandstone of the Scappoose Formation and basalt of the Columbia River Basalt Group (CRBG), which flowed in the area between about 17 million and 6 million years ago. These units are exposed at the ground surface along the northeast side of the city with smaller outcrops on the east and west sides of the city (see Figure 1).

Based on maps and cross sections prepared by Frank and Collins (1978), the CRBG in the project area is overlain by Pliocene (5.3 to 2.6-million-year-old) Troutdale Formation, which locally consists of silt and clay with occasional beds of sand and gravel. These sediments have historically been referred to by several names, including Troutdale Formation (Schlicker and Deacon, 1967; Frank and Collins, 1978), Sandy River Mudstone equivalent (Madin, 1990), and Hillsboro Formation (Wilson, 1998). These sediments, referred to in this report as Pliocene Alluvium, were deposited in local sub-basins that had been created by

extensive faulting and folding of the CRBG and underlying basement rocks (Schlicker and Deacon, 1967). In the vicinity of the City, small outcrops are mapped to the northeast and north (see Figure 1).

Throughout most of the City, the Pliocene Alluvium is concealed at the surface by Pleistocene flood sediments (see Figure 1). The Pleistocene flood sediments were deposited during repeated glacial outburst floods (O'Connor and others, 2001). During the late stages of the last great ice age, between about 18,000 and 15,000 years ago, a lobe of the continental ice sheet repeatedly blocked and dammed the Clark Fork River in western Montana, which then formed an immense glacial lake called Lake Missoula. The lake grew until its depth was sufficient to buoyantly lift and rupture the ice dam, which allowed the entire massive lake to empty catastrophically. Once the lake had emptied, the ice sheet again gradually dammed the Clark Fork Valley, and the lake refilled, leading to 40 or more repetitive outburst floods, at intervals of decades (Allen and others, 2009). The floods are collectively known as the Missoula Floods, and during each short-lived episode, floodwaters washed across the Idaho panhandle, through the eastern Washington scablands, and through the Columbia River Gorge.

When the floodwater emerged from the western end of the gorge, it deposited a tremendous load of boulders, cobbles, and gravel nearest the mouth of the gorge and along the main channel of the Columbia River. Floodwaters stretched along most of the Willamette Valley, creating a temporary lake known as Lake Allison (Orr and others, 1992). Once spread out, the lower-energy waters deposited variable thicknesses of micaceous sand and silt throughout the Willamette Valley, as far south as Eugene (Allen and others, 2009). Within the vicinity of the City, several authors, including Schlicker and Deacon (1967) and Frank and Collins (1978), refer to the fine-grained sediments as Willamette Silt. In this report, we have adopted the name Fine-Grained Missoula Flood Deposits, after more recent mapping by O'Connor and others (2001). In Figure 1, the Fine-Grained Missoula Flood Deposits are mapped as Missoula Flood Deposits.

Additional, more recent geologic units, which appear throughout the project site, and are included on Figure 1, are Landslide Deposits, Floodplain Deposits, and Alluvium of Smaller Streams. The Landslide Deposits were added to the site geologic map based on mapping from SLIDO 3.4 (Burns and Watzig, 2017). Landslide deposits typically consist of a mix of unconsolidated rock, soil, sediment, and colluvium. Only a single landslide deposit was added to the geologic map of the project site in the northeast corner of Figure 1. Within the southern portion of the project site, Holocene and upper Pleistocene Floodplain Deposits are mapped around the Willamette River. These units, which were mapped by O'Connor and Others, 2001, consist of unconsolidated silt, sand, and gravel. This unit incorporates both active channels and modern floodplains. In some areas, this unit can reach 15 meters in

thickness. The Alluvium of Smaller Streams, which is also in the southern section of the project site, is predominantly made up of unconsolidated clay, silt, sand, and some gravel. This unit is differentiated from the Floodplain Deposits based on the size of the stream which deposited it.

2.2.4 Available Mapping

DOGAMI developed a publication based on the Oregon Resilience Plan CSZ scenario for the state of Oregon. The publication, Open-File Report O-13-06, primarily consists of GIS data of site conditions, ground motions, ground deformations, and other hazards associated with a magnitude 9.0 event on the CSZ (Madin and Burns, 2013). Datasets of interest for this project include the following:

- Shear Wave Velocity within 30 meters of the Ground Surface (Vs30)
- Bedrock and Site Peak Ground Acceleration (PGA)
- Bedrock and Site 1-second Spectral Acceleration (SA1)
- Bedrock and Site Peak Ground Velocity (PGV)
- Liquefaction Susceptibility, Probability, and Permanent Ground Deformation (PGD)
- Earthquake-Induced Landslide Susceptibility, Probability, and PGD

The provided methodology indicates that, within the project area, the majority of these datasets were derived based on the Relative Earthquake Hazard Map of the Portland Metro Region (IMS-1; Mabey and others, 1997); the Oregon Geologic Data Compilation Release 5 (OGDC-5; Ma and others, 2009); and the Statewide Landslide Information Database for Oregon Release 2 (SLIDO-2; Burns and others, 2011). The bedrock ground motions included in the publication were provided to DOGAMI by the U. S. Geological Survey (USGS) and are based on the USGS Cascadia M 9.0 scenario ShakeMap®.

Following the publication of O-13-06, DOGAMI published the Oregon Geologic Data Compilation Release 6 (OGDC-6; Smith and Roe, 2015) and Release 3.4 of the Statewide Landslide Information Database for Oregon (SLIDO-3.4; Burns and Watzig, 2017). These recent publications have not yet been incorporated into DOGAMI's CSZ scenario datasets.

Bedrock 0.3-second spectral acceleration data were downloaded from the USGS website for the Cascadia M 9.0 scenario ShakeMap® (USGS, 2011). Data for the 0.2-second spectral acceleration, as used in building codes, were not available. For preliminary planning purposes, the 0.2-second spectral acceleration can be approximated as the 0.3-second spectral acceleration.

2.3 Modifications to Published Geologic Mapping

Our geologic study draws on data from the O-13-06 document which characterizes the geologic hazards for the Cascadia Subduction Zone event, but also incorporates landslide data from SLIDO 3.4 and new geologic information from the OGDC-6. The OGDC dataset combines the best-known geologic mapping of the entire state into a single database. While more recent mapping of the area has been completed, most notably USGS Open-File Report 2018-1044, the digital files were not made available when both DOGAMI and the USGS were contacted. Minor modifications were made to the OGDC-6 layer based on metadata within the file.

Using the OGDC-6 as the geologic base map, we overlaid and added in deposits from SLIDO-3.4 that were not included in the geologic map. Within the entire study area, only a single landslide deposit had to be added in the northeast portion of the study area. The resulting final map is shown on Figure 1.

2.4 Seismic Hazard Maps

The purpose of the maps is to delineate the ground shaking and permanent ground deformation hazard across the service area based on a magnitude 9.0 CSZ earthquake. Ground shaking hazard is delineated in terms of the following:

- Peak ground acceleration (PGA)
- 0.3-second spectral acceleration (SA0.3)
- 1-second spectral acceleration (SA1)
- Peak ground velocity (PGV)

Permanent ground deformation (PGD) hazard is delineated by the following:

- Probability of liquefaction
- Liquefaction-induced lateral spread PGD
- Liquefaction-induced settlement PGD
- Probability of earthquake-induced sliding in both wet and dry conditions
- Landslide-induced PGD in both wet and dry conditions

These maps were derived using the same approach as the published DOGAMI O-13-06 magnitude 9.0 CSZ scenario maps but using more recently published background information and more targeted assumptions about local conditions. We provide maps of the updated information (i.e., most recent geologic map in Figure 1) and maps developed as intermediate steps (i.e., Figure 3, Liquefaction Hazard, and Figures 4 and 5, Landslide Susceptibility in both wet and dry conditions) in deriving the final hazard maps.

Modifications to both the O-13-06 methodology and additional input maps are summarized below.

2.5 Shear Wave Velocity, V_{s30}

For the study area around Newberg, there are published DOGAMI maps which show V_{s30} values. However, because multiple methodologies were used across the area, the data lacks uniformity. Additionally, there are no 3D shear wave velocity models such as exist for the Portland metropolitan area. Therefore, due to the limited availability of V_{s30} data throughout the project study area, values were assigned based on NEHRP site classes. In our opinion, this was the best way to create a unified map. To do this, V_{s30} values from Holzer and others (2005), which are adapted from BSSC (2001), were assigned to each geologic unit based on its site class. In the determination of site classes, both published classes in O-13-06 as well as interpretation of geologic units were used. Both the site class and V_{s30} values assigned to each geologic category are shown below. These values should be considered estimates and assume that the material in the upper 100 feet is uniform.

- Columbia River Basalt: Site Class B, 1130 m/s
- Troutdale and Scappoose Formations: Site Class B/C Boundary, 760 m/s
- Landslide deposits overlying rock: Site Class C, 540 m/s
- Landslide deposits overlying flood deposits: Site Class D, 270 m/s
- Missoula Flood Deposits: Site Class D, 270 m/s
- Floodplain Deposits and Alluvium of Smaller Streams: Site Class D to E, 180 m/s

While some published DOGAMI maps classify landslide deposits as Site Class F, it is our opinion that the deposits do not meet the criteria of Site Class F material, as defined in the Hazus® -MH 2.0 Technical Manual (FEMA, 2011). The final V_{s30} map is shown on Figure 2.

2.6 Liquefaction Hazard

The liquefaction susceptibility map provided in O-13-06 is a compilation of liquefaction susceptibility maps from other DOGAMI publications. Within the Newberg area, this includes both IMS-7 and IMS-24. Explanatory texts for both of these interpretive map series indicate that susceptible units were assumed to be saturated. This was believed to be a conservative approach as the majority of highly liquefiable sediment is restricted to alluvial deposits in areas of low relief and high rainfall. However, comparison of the maps revealed that different methodologies were used to determine liquefaction susceptibility. This meant that susceptibility within the same unit could vary significantly across the boundary between IMS-7 and IMS-24. Therefore, we used our updated geologic map (Figure 1) and employed the Youd and Perkins (1978) methodology, as well as knowledge of regional

liquefaction susceptibility, to assign new liquefaction susceptibilities and create a unified map. The resulting map is shown on Figure 3.

2.7 Landslide Susceptibility

We generally followed the methodology and Geologic Group assignments as described in O-13-06, using the compiled geologic map shown on Figure 1 and discussed above, as the base map. We assigned Geologic Group C (relatively weak material) to areas mapped as Alluvial of Smaller Streams, Missoula Flood Deposits, Floodplain Deposits, and Landslide Deposits. All other geologic units, including Columbia River Basalt, Scappoose Formation, and Troutdale Formation, were assigned Geologic Group B. We calculated a slope map from bare earth lidar data of the area to complete the landslide susceptibility map because DOGAMI's slope map was not included in O-13-06. In order to give what we believe are upper and lower limits of landslide susceptibility, maps accounting for both dry and wet conditions were generated. Dry conditions assume that the groundwater is below the level of sliding, while wet conditions assume that the groundwater level is at ground surface. The landslide susceptibility maps are shown on Figures 4 and 5.

2.8 PGA, SA1, SA0.3, and PGV

The site amplification factors in O-13-06 were calculated based on site class and the appropriate V_{s30} value for each site, as determined when creating the V_{s30} map as described above. We calculated the PGA and SA1 site amplification factors for the Newberg area from the V_{s30} raster described above using the approach referenced in O-13-06 (Boore and Atkinson, 2008) and applied them to the bedrock PGA and SA1 maps provided with O-13-06 to produce PGA, SA1, and PGV maps modified for Site Class.

Maps of Peak Ground Acceleration, 1-Second Spectral Acceleration, and Peak Ground Velocity are shown on Figures 6, 8, and 9, respectively. The same methodology was used for the 0.3-Second Spectral Acceleration map, shown in Figure 7, using the bedrock SA0.3 map from the USGS scenario. It should be noted that current USGS & DOGAMI mapping does not include mapping for the 0.2-second spectral acceleration, but it does include spectral acceleration for a period of 0.3 seconds. For preliminary planning purposes the 0.2-second spectral acceleration can be approximated as the 0.3-second spectral acceleration.

2.9 Probability of Liquefaction

We used the refined liquefaction hazard map described above and followed the methods presented in O-13-06 to develop a map of liquefaction probability. Because we assigned a liquefaction susceptibility of "Low to Moderate" for Missoula Flood Deposits, its P_{ml} value, which is defined as the proportion of a map unit susceptible to liquefaction, had to be

interpreted. Because geologic units with low and moderate susceptibilities have P_{ml} values of 0.05 and 0.1 respectively. Therefore, Missoula Flood Deposits were assigned a P_{ml} of 0.075. The resulting map is shown on Figure 10.

2.10 Liquefaction-Induced PGD

2.10.1 Lateral Spreading

We used the refined liquefaction hazard map described above and followed the methods presented in O-13-06 to calculate permanent ground deformations from liquefaction-induced lateral spreading. The map of estimated PGD due to lateral spreading is included on Figure 11.

2.10.2 Settlement

DOGAMI did not include a map of predicted ground settlement associated with liquefaction in O-13-06. We calculated estimated liquefaction-induced settlements following the methodology in Chapter 4 of the Hazus® -MH 2.0 Technical Manual (FEMA, 2011), using the refined liquefaction hazard map discussed above.

The FEMA method associates each susceptibility category with a unique settlement amplitude value. Each of the values is assumed to have an uncertainty with a uniform probability distribution from one-half to two times the respective value. The map of estimated PGD due to liquefaction-induced settlement is included on Figure 12.

2.11 Probability of Earthquake-Induced Landslides

We used the refined landslide susceptibility and PGA maps described above and followed the methods presented in O-13-06 to calculate and map the probability of earthquake-induced landslides. To give what we believe are upper and lower limits of the probability of earthquake-induced landslides, we calculated probabilities in both wet and dry conditions. This was done by populating tables 4.17 and 4.18 in Chapter 4 of the Hazus® -MH 2.0 Technical Manual (FEMA, 2011). The resulting maps are shown on Figures 13 and 14.

2.12 Earthquake-Induced Landslide PGD

The earthquake-induced landslide PGD map is based on the methodology in Hazus® -MH 2.0 Technical Manual (FEMA, 2011), which is referenced in O-13-06. We retained the acceleration term that DOGAMI chose to remove from FEMA equation 4-25 because the acceleration is in “decimal fraction of g 's,” not cm/sec^2 , as DOGAMI indicated.

Additionally, we observed that the equation given by DOGAMI for the displacement factor did not produce a curve similar to the FEMA Figure 4.14 relationship. In examining the DOGAMI equation, we saw that if the first constant was made negative, a curve similar to the FEMA Figure 4.14 relationship was seen. Therefore, we based our calculations on this slightly amended and corrected relationship to match the source FEMA publication. As we did for all landslide maps, we generated permanent ground deformation maps for both wet and dry conditions. These maps were based on probability inputs generated when calculating the probability of earthquake-induced landslides. Our maps of estimated earthquake-induced landslide permanent ground deformation are shown on Figures 15 and 16.

2.13 Seismic Hazards at Critical Infrastructure

The locations of selected infrastructure have been provided by HDR. The approximate locations of the selected infrastructure are shown on Figures 1 through 16 and a summary of the GIS map results for seismic hazards at these specific locations are shown on an attached Table 1.

3 WATER TREATMENT PLANT SLOPE EVALUATION

3.1 Background

The existing WTP is adjacent to a steep slope that is north of the Willamette River. The site also contains a pipe bridge that extends from the crest of the north slope to the well fields south of the Willamette River. We understand based on existing information that the north slope has had periods of instability. Most notably, a slide occurred along the north slope in the spring of 1996 and was documented in a report prepared by Squier Associates dated June 24, 1999. A repair to the slope consisting of a rock buttress was designed and documented by Squier Associates in a summary report dated June 28, 2002. According to the summary report, the slope repair was completed on October 26, 1999.

An additional slope evaluation was performed by Northwest Geotech, Inc. (NGI), and was documented in a summary letter dated November 8, 2016. According to the findings in the NGI summary letter, recent and historic landslides have been observed along the riverbank near the existing pipe bridge. We understand that there are two inclinometers installed along the north slope. One inclinometer is located near the existing pipe bridge and the other is south of the existing WTP. However, the data from the two inclinometers was not made available at the time of this report.

The approximate location of the WTP site is shown on Figure 17, Vicinity Map and the current explorations and slope stability section are shown on Figure 18.

3.2 Subsurface Conditions

The field exploration program for the project included two geoprobes, designated P-1 and P-2, and two cone penetration tests (CPTs), designated CPT-1 and CPT-2. The approximate locations of the explorations are shown on Figure 18. The explorations were performed on May 20, 2019. The two geoprobes were advanced to depths ranging from 30 to 68 feet and the two CPTs were advanced to depths ranging from 68 to 83 feet below the existing ground surface (bgs). Details of the field explorations, including techniques used to advance and sample the geoprobes and cone penetration tests, are presented in Appendix A, Field Explorations.

We grouped the materials encountered in our field explorations into three geotechnical units, as described below. This interpretation of the subsurface conditions is based on the explorations and regional geologic information from published sources. The geological units are as follows:

- **Fill:** Silty Gravel with Sand (GM) to Silt with Sand (ML), wood debris also encountered;
- **Fine-Grained Missoula Flood Deposits:** Silt (ML), Silt with Sand (ML), Sandy Silt (ML), Silty Sand (SM), Lean Clay (CL), Fat Clay (CH); and
- **Hillsboro Formation:** Fat Clay (CH).

These geological units were grouped based on their engineering properties, geologic origins, and distribution in the subsurface.

3.3 Groundwater

The depth to groundwater was estimated from a dissipation test performed within CPT-1. According to the results of the dissipation test, the depth to groundwater is approximately 35 feet bgs.

3.4 Seismic and Geologic Hazards

The seismic hazard evaluation for this project was conducted in accordance with the American Society of Civil Engineer's (ASCE) Minimum Design Loads for Buildings and Other Structures, 2016 Edition (ASCE 7-16), which is based on earthquake ground motions with a 2,475-year return period.

3.5 Strong Ground Motion

ASCE 7-16 requires that geotechnical hazard analyses (liquefaction, specifically) be performed for Maximum Considered Earthquake Geometric Mean (MCE_G) ground motions and adjusted for site class effects. Specifically, the peak ground acceleration used in the liquefaction-related hazard analyses, PGA_M , is defined as:

Exhibit 1: Site-Adjusted Peak Ground Acceleration

Equation	Variable and Definition
$PGA_M = F_{PGA} \times PGA$	PGA_M MCE_G Peak Ground Acceleration Adjusted for Site Class Effects
	F_{PGA} Site Coefficient from ASCE 7-16 Table 11.8-1
	PGA MCE_G Peak Ground Acceleration of Site Class B/C Boundary Conditions

Reference: ASCE 7-16, Equation 11.8-1

For this project, we obtained a PGA_M of 0.474g using a PGA of 0.392g and an F_{PGA} of 1.208. PGA is shown in ASCE 7-16 Figure 22-9 and is derived from the most recent USGS National Seismic Hazard Mapping Project ground motion hazard analyses results by Petersen and others (2014). F_{PGA} is a function of site class and PGA as indicated in ASCE 7-16 Table 11.8-1. The shear wave velocities measured in CPT-1 correspond to Site Class D.

3.6 Liquefaction

Liquefaction is a phenomenon in which excess pore pressure of loose to medium dense, saturated, nonplastic to low plasticity silts and granular soils increases during ground shaking. The increase in excess pore pressure results in a reduction of soil shear strength and a quicksand-like condition.

Soil behavior under seismic loading is the primary factor in determining the susceptibility of a soil to liquefaction. Important factors in evaluating soil behavior are relative density, the fines content (percent of soil by weight smaller than 0.075 millimeter, passing the No. 200 sieve), and the plasticity characteristics of the fines. Relative density is estimated based on methods including Standard Penetration Test (SPT) N-values, CPT tip resistances, and shear wave velocity.

The second major component of a liquefaction study is the design earthquake motions. Seismogenic sources that contribute to the seismic hazards at the site include the CSZ interface, CSZ Benioff zone, and local shallow crustal faults. Because the maximum earthquake magnitudes for sources vary significantly, we used a mean maximum magnitude of 7.5 for ground motions with a 2,475-year return period for liquefaction analyses.

3.7 Liquefaction Analysis and Liquefaction-Induced Settlement

Shannon & Wilson evaluated liquefaction potential of the soils by performing liquefaction analyses on the CPTs using the Boulanger and Idriss (2014) method. The liquefaction analysis for CPT soundings was accomplished using the computer program CLiq Version 2 by GeoLogismiki, which incorporates the Boulanger and Idriss (2014) method. Shannon & Wilson used the ground motion parameters described above (i.e., PGA of 0.474g at the surface and moment magnitude 7.5). Soil layers identified as potentially liquefiable in the explorations are summarized in Exhibit 2.

Exhibit 2: Summary of Liquefaction-Induced Settlement

Location	Approximate Ground Surface Elevation (feet)	Approximate Groundwater Elevation (feet)	Approximate Liquefiable Layer Depth (feet)	Approximate Settlement at Ground Surface (inches)
CPT-1	170	135	35 to 45	1.5
CPT-2	170	135	36 to 46	1

Exhibit 2 also presents total estimated liquefaction-induced settlement at the ground surface. Liquefaction-induced settlement magnitudes based on CPT soundings were estimated using Zhang et al. (2002).

3.8 Lateral Spreading

Lateral spreading hazards can exist in areas with mild slopes adjacent to a much steeper slope or vertical face. Lateral spreading failure can occur if soil liquefaction develops during a seismic event and the ground acceleration (inertial force) briefly surpasses the yield acceleration (shear strength) of the liquefied soil. This can cause both the liquefied soil and an overlying non-liquefied crust of soil to displace laterally down mild slopes or towards an embankment face. The displacements are cumulative and permanent in nature.

Shannon & Wilson performed a preliminary screening of lateral spreading hazards at the site using the Zhang et al. (2004) methodology. The results of the Zhang et al. (2004) analyses at the project site indicate lateral spread displacements may be up to approximately 2 feet at a distance of approximately 300 feet from the crest of the slope, which would impact existing infrastructure at the WTP site. More accurate assessments of the liquefaction-related hazards present at the site may be made using non-linear time history numerical models that explicitly model the buildup of excess pore water pressure in the soil and associated soil strain (e.g. 2-dimensional FLAC analyses). However, these analyses are beyond the scope of this project.

3.9 Slope Stability

We performed a slope stability analysis at one cross-section through the slope adjacent to the existing pipe bridge, based on available topographic information (i.e. LiDAR), and our subsurface explorations. The subsurface groundwater was based on the water level estimated from our CPT explorations and the water level within the Willamette River was based on the gage height measured from the nearest river gage. Also, the riverbed elevation was estimated from a USGS bathymetric survey performed in 2002.

3.9.1 Approach

Slope stability is influenced by various factors, including the following: (1) the geometry of the soil mass and subsurface materials; (2) the weight of soil materials overlying a potential failure surface; (3) the shear strength of soils and/or rock along a potential failure surface; and (4) the hydrostatic pressure (groundwater levels) present within the soil mass and along a potential failure surface.

The stability of a slope can be expressed in terms of a factor of safety, which is defined as the ratio of resisting forces to driving forces. At equilibrium, the factor of safety is equal to 1.0, and the driving forces are balanced by the resisting forces. Slope movement is predicted when the driving forces exceed the resisting forces, i.e., the factor of safety is less than 1.0.

An increase in the factor of safety greater than 1.0, whether by increasing the resisting forces or decreasing the driving forces, reflects a corresponding increase in the stability of the mass. The actual factor of safety may differ from the calculated factor of safety, due to variations or uncertainty in the soil strength, subsurface geometry, potential failure surface location and orientation, groundwater level, and other factors that are not completely known.

Shannon & Wilson performed the slope stability analysis using the computer program SLOPE/W, Version 10.0.0.17401 (Geo Slope International, 2018). The Morgenstern-Price method was used for rotational and irregular surface failure mechanisms. We utilized information from the closest explorations to estimate material strength and unit weight parameters for the geologic units assumed to underlie the slope. Specifically, strength correlations based on the CPTs were used. Liquefied strength parameters were developed from CPT correlations.

The slope stability was evaluated for the static, seismic, and post-seismic (liquefied soil) conditions. See discussions of these various conditions below and Exhibit 3 for tabulations of the results of our slope stability analyses.

3.9.2 Static

For slopes supporting or impacting essential facilities, a minimum factor of safety of 1.5 is recommended for the static condition.

3.9.3 Seismic

A minimum factor of safety of 1.1 is recommended for the seismic case. Shannon & Wilson performed pseudo-static analyses to evaluate the seismic slope stability using a horizontal seismic coefficient of 0.237, which is equal to one-half of the PG_{AM} . If the factor of safety of the critical failure surface was less than 1.1, potential displacements were estimated using the procedures in the National Cooperative Highway Research Program (NCHRP) document NCHRP 611 (NCHRP, 2008).

3.9.4 Post-Seismic

A minimum factor of safety of 1.1 is recommended for the post-seismic (liquefied) condition. A failure surface with a factor of safety less than 1.1 indicates the potential for a flow failure caused by a loss of strength within a liquefied soil layer. A flow failure is initiated when a shear failure occurs along a failure surface and is often characterized by large rapid ground movement of the soil mass inside the failure zone.

3.9.5 Results of the Slope Stability Analysis

We evaluated the stability of the slope for static, seismic, and post-seismic conditions. Based on our analysis, the slope is marginally stable under static conditions and is not stable in seismic or post-seismic conditions. The slope stability results are summarized in Exhibit 3 and plots of the results are shown in Appendix B.

Exhibit 3: Summary of Slope Stability Results

Condition	Factor of Safety
Static	1.02
Seismic	0.65
Post-Seismic	0.75

Stability analyses performed for the seismic and post-seismic case indicated that the slope had a factor of safety less than 1.1. Therefore, based on the results, seismically induced displacements and/or flow failures could occur at this site during and after a seismic event. As mentioned previously, lateral spreading (i.e. flow failure) displacements could be in the range of approximately 2 feet at a distance of approximately 300 feet from the crest of the slope. Seismically induced ground deformations using the methods outlined in NCHRP (2008) could be in the range of approximately 7.5 feet.

4 LIMITATIONS

This report, data collection, and hazard mapping has been completed for the exclusive use of HDR, Inc., and the City of Newberg for specific application to the Water System Seismic Resiliency project.

No interpretations between exploration locations are included in this report. The interpretations, conclusions, and recommendations that are contained in this report were prepared in accordance with generally accepted professional geotechnical engineering principles and practices in this area at the time this report was prepared. We make no warranty, either express or implied.

The scope of our geotechnical services described in this report has not included an environmental evaluation regarding the presence or absence of hazardous or toxic materials in the soil, surface water, groundwater, or air, on or below the site for evaluation or disposal of contaminated soils or groundwater, should they be encountered, except as noted in this report.

The subsurface explorations were performed to characterize soil conditions at limited locations at the site and our observations are specific to the locations and depths noted on the explorations and in this report. No amount of subsurface exploration can precisely predict the characteristics, quality, or distribution of subsurface site conditions. Potential variation includes but is not limited to the following: varying conditions between borings, changes to the site and subsurface conditions due to the passage of time or intervening causes (natural and manmade), and seasonal or recharge source-influenced fluctuations of groundwater conditions.

Shannon & Wilson has prepared a document, "Important Information About Your Geotechnical/Environmental Report," to assist you and others in understanding the use and limitations of this document. This document is attached to the end of this report.

5 REFERENCES

- Allen, J.E., Burns, M., and Burns, S., 2009, *Cataclysms on the Columbia: The Great Missoula Floods* (2nd ed.): Portland, Oregon, Ooligan Press, 204 p.
- American Society of Civil Engineers, 2017, *Minimum design loads and associated criteria for buildings and other structures*: Reston, Va. American Society of Civil Engineers, ASCE Standard ASCE/SEI 7-16, 2 v.
- Boore, D. M. and Atkinson, G. M., 2008, Ground-motion prediction equations for the average horizontal component of PGA, PGV, and 5%-damped PSA at spectral periods between 0.01 s and 10.0 s: *Earthquake Spectra*, v. 24, no. 1, p. 99-138.
- Burns, S., Growney, L., Brodersen, B., Yeats, R.S., and Popowski, T.A., 1997, *Map showing faults, bedrock geology, and sediment thickness of the western half of the Oregon City 1:100,000 quadrangle, Washington, Multnomah, Clackamas, and Marion Counties, Oregon*: Oregon Department of Geology and Mineral Industries Interpretive Map Series IMS-4.
- Burns, W. J.; Mickelson, K. A.; and Saint-Pierre, Evan C., 2011, *Statewide landslide information database for Oregon, release 2 (SLIDO-2)*: Oregon Department of Geology and Mineral Industries Digital Data Series SLIDO-2, scale 1:750,000.
- Burns, W.J., and Watzig, R.J., 2017, *Statewide landslide information database for Oregon, release 3.4 (SLIDO-3.4)*: Oregon Department of Geology and Mineral Industries Digital Data Series SLIDO-3.4, scale 1:750,000.
- Boulanger, R. W. and Idriss, I. M., 2014, *CPT and SPT-based liquefaction triggering procedures*: Davis, Calif., University of California Davis, Center for Geotechnical Modeling, report UCD/CGM-14/01, 134 p.
- Federal Emergency Management Administration, 2011, *HAZUS-MH Technical Manual, Release 2.0*.
- Frank, F. J., and Collins, C. A. (1978). *Groundwater in the Newberg Area, Northern Willamette Valley, Oregon*: United States Department of the Interior Geological Survey, Ground Water Report No. 27.
- Geo-Slope International, 2018, *SLOPE/W 2018*: Calgary, Alberta, Geo-Slope International.
- Holzer, T. L.; Bennett, M. J.; Noce, T. E.; and Tinsley, J. C., 2005, Shear-wave velocity of surficial geologic sediments in northern California: statistical distributions and depth dependence: *Earthquake Spectra*, v. 21, no. 1, p. 161-177.

- Ishihara, Kenji and Yoshimine, Mitsutoshi, 1992, Evaluation of settlements in sand deposits following liquefaction during earthquakes: *Soils and Foundations*, v. 32, no. 1, p. 173-188.
- Ma, L., Madin, I.P., Olson, K.V., and Watzig, R.J., 2009, Oregon Geologic Data Compilation, Release 5: Oregon Department of Geology and Mineral Industries, OGDC-5.
- Madin, I.P., 1990, Earthquake-hazard geology maps of the Portland Metropolitan Area, Oregon: Oregon Department of Geology and Mineral Industries, Open-File Report O-90-2, scale 1:63,360.
- Madin, I.P., and Burns, W.J., 2013, Ground Motion, Ground Deformation, Tsunami Inundation, Coseismic Subsidence, and Damage Potential Maps for the 2012 Oregon Resilience Plan for Cascadia Subduction Zone Earthquakes: Oregon Department of Geology and Mineral Industries, Open-File Report O-2013-06.
- Mabey, M., Black, G.L., Madin, I.P., Meier, D.B., Youd, T.L., Jones, C.F., and Rice, J.B., 1997, Relative Earthquake Hazard Map of the Portland Metro Region, Clackamas, Multnomah, and Washington Counties, Oregon: Oregon Department of Geology and Mineral Industries, Interpretive Map Series IMS-1, scale 1:216,000.
- National Highway Cooperative Research Board, 2008, Seismic Analysis and Design of Retaining Walls, Buried Structures, Slopes, and Embankments: Transportation Research Board, Document 611.
- O'Connor, J.E., Sarna-Wojcicki, A., Wozniak, K.C., Polette, D.J., and Fleck, R.J., 2001, Origin, Extent, and Thickness of Quaternary Geologic Units in the Willamette Valley, Oregon: U.S. Geological Survey Professional Paper 1620.
- Oregon Seismic Safety Policy Advisory Commission (OSSPAC), 2013, The Oregon Resilience Plan.
- Orr, E.L., Orr, W.N., and Baldwin, E.M., 1992, *Geology of Oregon* (4th ed.): Dubuque, Iowa, Kendall/Hunt Publishing Co., 254 p.
- Petersen, M. D.; Moschetti, M. P.; Powers, P. M.; and others, 2014, Documentation for the 2014 update of the United States national seismic hazard maps: U.S. Geological Survey Open-File Report 2014-1091, 243 p.
- Schlicker, H.G. and Deacon, R.J., 1967, Engineering Geology of the Tualatin Valley region, Oregon: Oregon Department of Geology and Mineral Industries Bulletin B-60, 103 p., 5 app., 45 figs., 5 tables, 4 pls., scale 1:48,000.
- Smith, R.L., and Roe, W.P., 2015, Oregon Geologic Data Compilation, Release 6: Oregon Department of Geology and Mineral Industries, OGDC-6.

- Wells, R.E., Weaver, C.S., and Blakely, R.J., 1998, Fore-arc migration in Cascadia and its neotectonic significance: *Geology*, 26, p. 759-762.
- Wells, R.E., Haugerud, R., Niem, A., Niem, W., Ma, L., Madin, I., and Evarts, R., 2018, New geologic mapping of the northwestern Willamette Valley, Oregon, and its American Viticultural Areas (AVAs)—A foundation for understanding their terroir: U.S. Geological Survey Open-File Report 2018-1044, <https://doi.org/10.3133/ofr20181044>.
- Wilson, D.C., 1998, Post-middle Miocene geologic evolution of the Tualatin Basin, Oregon: *Oregon Geology*, v. 60, no. 5.
- Youd, T.L., and Perkins, D.M., 1978, Mapping Liquefaction-Induced Ground Failure Potential: *Journal of the Geotechnical Engineering Division*, Volume 104, Issue 4, p. 433-446.
- Zhang, G., Robertson, P.K., Brachman, R.W.I., 2002, Estimating liquefaction-induced ground settlements from CPT for level ground, *Canadian Geotechnical Journal*.
- Zhang, G., Robertson, P.K., Brachman, R.W.I., 2004, Estimating liquefaction-induced lateral displacements using the standard penetration test or cone penetration test, *Journal of Geotechnical and Geoenvironmental Engineering*.

Table 1 - Seismic Hazards Mapped at Selected Infrastructure Locations

Locations	Site Class	PGA (g)	0.3-Second SA (g)	1-Second SA (g)	Liquefaction- Induced Settlement (inches)	Liquefaction- Induced Lateral Spreading (inches)	Earthquake- Induced Landslide PGD (Wet) (feet)
North Valley Reservoir #1	D	0.163	0.486	0.301	0.5-1.5	0-0.1	~2 near slope 150 feet from reservoir
North Valley Reservoir #2			0.482				
Water Treatment Plant	D	0.163	0.599	0.297	0.5-1.5	~16 near slope 120 feet from plant	~20 near slope 120 feet from plant
Corral Creek Reservoir	B	0.133	0.251	0.107	0	0-0.1	~0.5 near slope 100 feet from reservoir