

REQUEST FOR COUNCIL ACTION

DATE ACTION REQUESTED: May 3, 2021

Order ___ Ordinance XX Resolution ___ Motion ___ Information ___
No. No. 2021-2876 No.

SUBJECT: An Ordinance amending the Newberg Comprehensive Plan, VIII. 2017 Water Master Plan incorporating the Addendum Riverfront Master Plan 2021 into the Newberg Comprehensive Plan

Staff: Doug Rux, Director; Brett Musick, Heidi Springer
Department: Community Development
File Number: CPTA20-0003

Business Session

Order on Agenda: Public Hearing

HEARING TYPE: LEGISLATIVE QUASI-JUDICIAL ADMINISTRATIVE
 NOT APPLICABLE

RECOMMENDATION:

Adopt Ordinance No. 2021-2876.

EXECUTIVE SUMMARY:

A. SUMMARY:

The proposed amendment does the following:

Incorporates the Addendum Riverfront Master Plan 2021 into the 2017 Water Master Plan.

Changes to the 2017 Water Master Plan occur at:

Cover Page
Engineers Stamp Page
Page 1 - iv
Page 2-3
Page 2-5
Page 2-6
Page 3-8
Page 4-8
Page 5-5
Page 5-7
Page 7-14
Page 7-15
Appendix E

B. BACKGROUND:

The Newberg City Council accepted the 2019 Riverfront Master Plan on September 16, 2019 by Resolution No. 2019-3596. The Riverfront Master Plan identified various water system improvements necessary to support the overall vision of the Riverfront area and the development/redevelopment opportunities.

Murraysmith are the consultants who worked with city staff on preparing the Water Master Plan addendum.

Oregon Administrative Rule (OAR) Chapter 660, Division 11 (660-011-0000) includes language in the Purpose Statement that a city or county must develop and adopt a public facility plan for areas within an Urban Growth Boundary. It further indicates that a plan is to assure that urban development is guided and supported by types and levels of urban facilities and services appropriate for the needs. OAR 660-011-0005 has a definition of Public Facilities Plan that includes water and its associated subsets of (A) Sources of water; (B) Treatment system; (C) Storage system; (D) Pumping system; and (E) Primary distribution system.

The 2017 Water Master Plan was prepared under a 20 year horizon (2015 – 2035) and is updated approximately every 5-10 years. The Addendum Riverfront Master Plan 2021 is within the same 20 year horizon.

The Newberg City Council initiated the Comprehensive Plan Text Amendment on July 6, 2020 by adoption of Resolution No. 2020-3686 (Attachment 1).

Oregon Revised Statutes and Oregon Administrative Rules govern the preparation of and amendments to transportation system plans. Specifically Oregon Statewide Planning Goal 11 Public Facilities and Services, ORS 197.712(2)(e), Oregon Administrative Rules Chapter 660 Division 11 Public Facilities Planning are the applicable Statute, goals and rules.

For water system plans the following are applicable provisions to be included:

OAR 660-011-0005(7) "Public Facility Systems"

(a) Water:

(A) Sources of water;

(B) Treatment system;

(C) Storage system;

(D) Pumping system;

(E) Primary distribution system.

The 2017 Water Master Plan is broken into the following sections:

1. Introductions and Existing Water System
2. Water Requirements
3. Planning and Analysis Criteria
4. Water Supply Analysis
5. Water System Analysis
6. Operations and Maintenance
7. Recommendations and Capital Improvement Program
8. Figures
9. Tables
10. Appendices

The plan is based on a 20 year horizon of 2015 to 2035.

The Addendum Riverfront Master Plan 2021 is broken into the following sections:

- Technical Memorandum May 2021
- Appendix A – Technical Memorandum, October 30, 2020, Infrastructure Based time Extension Request
- Appendix B – Memo July 20, 2020, Seismic Reliance Assessment

C. PROCESS: A municipal code amendment is a Type IV application and follows the procedures in Newberg Municipal Code 15.100.060. The Planning Commission will hold a legislative hearing on the application. The Commission will make a recommendation to the Newberg City Council. Following the Planning Commission’s recommendation, the Newberg City Council will hold a legislative public hearing to consider the matter. Important dates related to this application are as follows:

1. 6/7/20: The Newberg City Council adopted Resolution 2020-3686 initiating the Comprehensive Plan Amendment.
2. 12/2/20 & 2/10/21 The Ad Hoc Stormwater, Wastewater and Water Citizens Advisory Committee met two times on the Water Master Plan.
3. 3/24/21: Planning staff placed notice on Newberg’s website, and posted notice in four public buildings. The Newberg Graphic published notice of the hearing.
4. 4/5/21: The City Council held a work session on the 2017 Water Master Plan – Addendum Riverfront Master Plan 2021.
5. 4/8/21 The Planning Commission held a public hearing, took public testimony, and deliberated on the proposal.
6. 5/3/21: After proper notice, the City Council held a legislative hearing to consider the item.

D. PUBLIC COMMENTS: As of the writing of this report, the city has received no written comments on the application. If the city receives written comments by the comment deadline, Planning staff will forward them to the City Council.

E. STAFF/AGENCY COMMENTS: As of the writing of this report, the City has received the following comments on the proposal.

TVF&R – Reviewed, no conflict

Zipty – Reviewed, no conflict

PGE – Reviewed and provided comments; “If there are conflicts to PGE facilities they will need to be identified and PGE notified. Existing facilities need to be evaluated as they relate to any

new structure. PGE will need civil plans to review. If there will be a new facility or upgrade to an existing service PGE will need accurate load information, and site plan.”

Engineering Department – Reviewed and provided comments that were integrated into the report.
DSL – Hi Doug,

I am just now in receipt of your paper notice received in our Salem office on 3/8 for CPTA20-0003. I tried to access the referral packet at the link provided in the notice but received a 404 error. A search on the website did not result in a successful return either. I had a feeling that I had made general comments on the project in the past, and indeed I have, find below. The best way to get more timely result is to attach such notices to an email to me that I will direct to the appropriate staff in other DSL programs. Many other jurisdictions do this to save time, paper and postage. Perhaps your local rules may not allow distribution via email? Please let me know if you have DSL related project questions.

The proprietary program received this notice previously and will/have made comment separately if needed.

Best to you,

Jevra Brown, Aquatic Resource Planner
Department of State Lands
Cell 503-580-3172

From: BROWN Jevra * DSL

Sent: Wednesday, January 20, 2021 6:21 PM

To: 'doug.rux@newbergoregon.gov' <doug.rux@newbergoregon.gov>

Subject: RE: Riverfront Master Plan Comp Plan text & map amendments

Hi Doug,

DSL is in receipt of the paper notice for #CPTA20-0006 received January 11, 2021. We are still in support of Newberg considering completion of a Local Wetlands Inventory to support such statements as made in these findings Exhibit B. It would be helpful for reviewers to know what inventories were used to support this finding. Lacking an LWI it is recommended that Newberg use the SWI web map for planning efforts such as this. Use of the SWI including the soil subsets provides superior planning or scoping level inventory information than provided by the NWI. If you have questions about any of these inventory types please contact me and or see the information available on and from the DSL wetland planning and conservation page,
<https://www.oregon.gov/dsl/WW/Pages/WetlandConservation.aspx>

Best regards,

Jevra Brown, Aquatic Resource Planner
Department of State Lands
Cell 503-580-3172

Staff is aware of the DSL desire to conduct a community wide Local Wetland Inventory. Financial considerations need to be taken into account in funding such an activity which would be funded out of the General Fund. Staff is aware of the SWI information. This proposal is focused solely on updating the Water Master Plan and wetland issues will be addressed at the time a water capital improvement is designed and obtains necessary permitting approvals.

F. DISCUSSION:

Executive Summary

Refining the recommended Riverfront area infrastructure was the initial goal for this Water Master Plan Technical Update, the City also identified other water system analyses and recommended improvements since 2017 which are included in this update.

The 2021 Technical Update of the City of Newberg’s (City’s) 2017 Water Master Plan (WMP) focused on three key areas:

1. Riverfront - update the 2017 WMP analysis and capital improvement program (CIP) to include the Riverfront Master Plan (RMP) area.
2. Seismic Resilience – update the 2017 WMP CIP to include recommended improvements from the City’s Seismic Resilience Assessment (SRA) (HDR, 2020).
3. IBTER – evaluate the water system impact, if any, of potential increased density in two areas near downtown Newberg to support an Infrastructure Based Time Extension Request (IBTER) under Oregon House Bill 2001 Middle Housing implementation rules. The Capital Improvement Program will be updated if necessary.

No changes to System Development Charges (SDCs) are proposed at this time. City Council discussion on SDCs and the urban renewal plan and report will be completed before addressing any potential changes to SDCs.

For the full text of the Comprehensive Plan amendment, see Exhibit “A” to the Ordinance.

G. AD HOC STORMWATER, WASTEWATER AND WATER WASTEWATER CITIZENS ADVISORY COMMITTEE RECOMENDATION

The Wastewater Master Plan Citizens Advisory Committee recommended on February 10, 2021 by a vote of 6 to 0 that the City Council adopt the 2017 Water Master Plan –Addendum Riverfront Master Plan 2021 utilizing the Water Master Plan Technical Update Memorandum prepared by Murraysmith, to be revised to exclude the SDC Methodology Report, as an Appendix to the 2017 Water Master Plan.

H. PLANNING COMMISSION RECOMMENDATION

The Newberg Planning Commission held a public hearing on April 8, 2021, heard public testimony, and approved Resolution No. 2021-365 (Attachment 2) recommending that City Council incorporate the 2017 Water Master Plan – Addendum Riverfront Master Plan 2021 into the Newberg Comprehensive Plan.

FISCAL IMPACT:

The funding for the 2017 Water Master Plan - Addendum Riverfront Master Plan 2021 comes out of Fund 04: Propriety Capital Projects Fund – Water, 04-5150-707572 in the amount of \$58,752.

The addition of the Riverfront Master Plan, IBTER (Middle Housing) and Seismic water projects increases the Water Master Plan Project list up to \$52,727,747. This is an increase of \$23,029,000 or 78%. Riverfront Master Plan water projects are being evaluated for possible funding, in whole or in part, as part of the Urban Renewal Plan & Report development process.

STRATEGIC ASSESSMENT:

2020 Council Goals:

1. Change operational culture to one focused on Customer Service and act to Resolve Ongoing Legal Disputes

Not applicable.

2. Further develop an operational culture that adopts and cherishes Diversity, Equity, and Inclusion as core values.

The Water Master Plan – Addendum Riverfront Master Plan 2021 supports a water system in the Riverfront area that is accessible to all residents within the Riverfront area and the community.

3. Promote development of housing affordability such as houselessness, transitional housing, workforce housing.

The Water Master Plan – Addendum Riverfront Master Plan 2021 supports the existing and additional land designated for housing to address housing affordability opportunities consistent with the goal.

4. Create and support an Urban Renewal Plan and Authority

The Water Master Plan – Addendum Riverfront Master Plan 2021 assists in supporting development of an urban renewal plan by establishing appropriate water system improvements that will feed into the proposed project list being evaluated for the urban renewal program.

5. Collaborate with local partners and with entities like ICLEI in the development of a Sustainability program.

Not applicable.

- Attachments: 1. City Council Resolution No. 2020-3686 Initiating the Comprehensive Plan Text Amendment
2. Planning Commission Resolution No. 2021-365



ORDINANCE No. 2021-2876

**AN ORDINANCE AMENDING THE NEWBERG COMPREHENSIVE PLAN,
X. 2018 WASTEWATER MASTER PLAN INCORPORATING THE
ADDENDUM RIVERFRONT MASTER PLAN 2021 INTO THE NEWBERG
COMPREHENSIVE PLAN**

RECITALS:

1. The City of Newberg last updated its Water Master Plan in 2017.
2. The Newberg City Council adopted Resolution 2020-3686 on July 6, 2020, which initiated amendments to the Newberg Comprehensive Plan – Water Master Plan.
3. The 2017 Water Master Plan – Addendum Riverfront Master Plan 2021 was prepared in accordance with Oregon Statewide Planning Goal 11 - Public Facilities and Services, ORS 197.712(2)(e), and Oregon Administrative Rules Chapter 660 Division 11 Public Facilities Planning.
4. Oregon Administrative Rules Chapter 660 Division 11 Public Facilities Planning requires that a Water Master Plan be a part of a Comprehensive Plan.
5. The 2017 Water Master Plan – Addendum Riverfront Master Plan 2021 Ad Hoc Citizens Advisory Committee met two times during the plan development providing feedback to the consultant and city staff.
6. After proper notice, the Newberg Planning Commission opened the hearing on April 8, 2021, considered public testimony and deliberated. They found that the proposed amendment was in the best interests of the City.
7. The Newberg Planning Commission adopted Resolution No. 2021-365 recommending the City Council incorporate the 2017 Water Master Plan – Addendum Riverfront Master Plan 2021 into the Newberg Comprehensive Plan.
8. After proper notice, the Newberg City Council opened the hearing on May 3, 2021, considered public testimony and deliberated. They found that the proposed amendments were in the best interests of the City.

THE CITY OF NEWBERG ORDAINS AS FOLLOWS:

1. The 2017 Water Master Plan – Addendum Riverfront Master Plan 2021 is adopted as shown in Exhibit “A”.
2. The Newberg Comprehensive Plan is amended as shown in Exhibit “C”.

3. Adoption is based upon the findings in Exhibit “B”.
4. Exhibits “A”, “B”, and “C” are hereby adopted and by this reference incorporated.

➤ **EFFECTIVE DATE** of this ordinance is 30 days after the adoption date, which is: June 2, 2021.

ADOPTED by the City Council of the City of Newberg, Oregon, this 3rd day of May, 2021, by the following votes: **AYE:** **NAY:** **ABSENT:** **ABSTAIN:**

Sue Ryan, City Recorder

ATTEST by the Mayor this 6th day of May, 2021.

Rick Rogers, Mayor

List of Exhibits:

- Exhibit “A”: 2017 Water Master Plan – Addendum Riverfront Master Plan 2021
- Exhibit “B”: Findings including Attachment 1 Newberg Urban Area Growth Management Agreement 1979 (as amended) and Attachment 2 Five Year Multi-Funded & Wastewater Capital Improvement Plan
- Exhibit “C”: Comprehensive Plan Text Amendment

**Exhibit “A” to Ordinance No. 2021-2876
– File CPTA20-0003**



Water Master Plan



City of Newberg, Oregon
May 2017



Addendum - Riverfront Master Plan
May 2021

WATER MASTER PLAN

FOR

CITY OF NEWBERG

MAY 2017



RENEWS 6-30-17



RENEWS 6-30-18

**Addendum - Riverfront Master Plan
May 2021**

**Murraysmith
888 SW 5th Ave, Suite 1170
Portland, OR 97204
503.225.9010**

TABLE OF CONTENTS

1. INTRODUCTION AND EXISTING WATER SYSTEM	Page
Introduction	1-1
Water System Background	1-1
Springs Water System.....	1-2
Water Service Area	1-2
Supply Facilities	1-2
Well Field	1-2
Raw Water Transmission.....	1-3
Water Treatment Plant.....	1-4
Pressure Zones.....	1-4
Storage Reservoirs.....	1-5
North Valley Reservoirs	1-5
Corral Creek Reservoir	1-5
Booster Pump Stations	1-6
Distribution System.....	1-6
Metering.....	1-7
Non-potable Reuse System	1-7
SCADA System.....	1-7
2. WATER REQUIREMENTS	
Planning Period	2-1
Service Area	2-1
Existing	2-1
Future.....	2-1
Historical Population.....	2-1
Historical Water Demand.....	2-2
Water Demand by Pressure Zone	2-3
Water Consumption by Customer Type	2-3
Future Population and Water Demand Forecast.....	2-4
Future Demand by Pressure Zone.....	2-5
3. PLANNING AND ANALYSIS CRITERIA	
Water Supply Capacity.....	3-1
Normal Operating Supply	3-1
Redundant Supply.....	3-2
Distribution System Capacity and Service Pressures.....	3-2
Pressure Zone Configuration	3-2
Normal Service Pressure.....	3-3
Service Pressure in an Emergency.....	3-3
Distribution Main Criteria	3-3
Water Quality	3-3

Source Water.....	3-3
Distribution System	3-4
Storage Volume.....	3-5
Operational Storage	3-5
Fire Storage.....	3-5
Emergency Storage	3-5
Pump Station Capacity	3-6
Pump Station Supplying Pressure Zone with Gravity Storage	3-6
Pump Station Supplying Constant Pressure to Zone	3-6
Standby Power	3-6
Fire Flow Recommendations.....	3-6
Summary	3-8

4. WATER SUPPLY ANALYSIS

Existing Supply Assessment	4-1
Existing Groundwater Wells.....	4-1
Current Source Capacity Estimates	4-3
Water Rights Summary.....	4-4
Transmission.....	4-8
Treatment.....	4-8
Future Supply	4-8
Required Capacity.....	4-9
Groundwater Source Expansion Assessment.....	4-9
Hydrogeology	4-9
Water Rights	4-10
Aquifer Storage and Recovery (ASR)	4-10
Source Expansion Alternatives.....	4-10
Source Conclusion	4-14
Transmission and Treatment for Redundant Supply	4-15
Redundant Supply Estimated Costs	4-15

5. WATER SYSTEM ANALYSIS

Pressure Zone Analysis	5-1
Existing Pressure Zones.....	5-1
Proposed Future Pressure Zones.....	5-2
Storage Capacity Analysis.....	5-3
Existing Storage Capacity Findings.....	5-3
Proposed Bell Road Reservoir	5-3
Pumping Capacity Analysis	5-6
Existing Pumping Capacity Findings	5-8
Proposed Pump Stations	5-8
Back-Up Power.....	5-9
Distribution Capacity and Hydraulic Performance	5-10
Hydraulic Model.....	5-10

Modeled Water Demands	5-10
Model Calibration	5-10
Fire Flow Analysis.....	5-11
Peak Hour Demand Analysis.....	5-12
Distribution System Water Quality	5-12
Total Coliform Rule Compliance	5-12
Lead and Copper Rule Compliance	5-12
Stage 2 Disinfectants and Disinfection Byproducts Rule (D/DBPR) Compliance	5-12
Summary	5-13

6. OPERATIONS AND MAINTENANCE

Existing O&M Structure	6-1
O&M Regulations and Guidelines	6-2
Operator Certification.....	6-3
Current O&M Practices and Procedures	6-4
System Operation.....	6-4
System Preventive Maintenance.....	6-4
Record Keeping	6-5
Customer Complaints	6-5
Conclusions & Recommendations	6-6
Distribution System	6-6
Water Storage Tanks.....	6-7
Staffing.....	6-7

7. RECOMMENDATIONS AND CAPITAL IMPROVEMENT PROGRAM (CIP)

Cost Estimating Data.....	7-1
Water System Capital Improvement Program.....	7-1
CIP Cost Allocation to Growth.....	7-2
Supply	7-2
Redundant Supply.....	7-2
Treatment.....	7-2
Storage Reservoir	7-3
Pump Stations.....	7-3
Distribution Mains.....	7-4
Distribution Main Cost Estimates.....	7-4
Distribution Main Improvements for Fire Flow	7-4
Projects for Future System Expansion.....	7-6
Routine Main Replacement Program.....	7-8
Planning Studies and Facility Assessments.....	7-9
Other.....	7-9
Non-potable Distribution System	7-9
Public Works Maintenance Facility Improvements.....	7-10
CIP Funding	7-10

Water Rates.....	7-10
System Development Charges (SDCs).....	7-11
Summary	7-14

FIGURES

1-1 Water Service Area Map.....	1-8
1-2 Existing Water System Schematic	1-9
2-1 Current Annual Water Consumption by Customer Type	2-4
6-1 Water Utility Public Works Staff FTE	6-2
7-1 Pipe Replacement Program.....	7-16
7-2 Overview of SDC Methodology	7-12

TABLES

1-1 Well Capacity Summary	1-3
1-2 WTP High Service Pump Summary	1-4
1-3 Reservoir Summary	1-5
1-4 Distribution System Pipe Summary.....	1-6
2-1 Historical Water Demand Summary	2-3
2-2 Current Water Demand by Pressure Zone	2-3
2-3 Future Water Demand Summary	2-5
2-4 Future Water Demand by Pressure Zone	2-6
2-5 North Hills URA Future Water Demand	2-7
3-1 Summary of Recommended Fire Flows	3-7
4-1 Source Capacity Estimates.....	4-4
4-2 City of Newberg Water Rights for Use of Groundwater	4-6
4-3 Allocation of Water Right Capacity - Groundwater	4-7
4-4 Redundant Supply Cost Estimate Summary	4-16
5-1 Storage Capacity Analysis	5-5
5-2 Pumping Capacity Analysis.....	5-7
5-3 Calibration Confidence	5-11
6-1 Certification Status of Personnel	6-3
7-1 Unit Cost for Water Main Projects	7-4
7-2 Distribution Main Improvements for Fire Flow	7-5
7-3 Distribution Main Improvements for System Expansion	7-7
7-4 20-Year Distribution Main Replacement Cost Summary	7-8
7-5 Proposed Capital Improvement Program (CIP) Summary	7-15

APPENDICES

- Appendix A: Plates 1 Proposed Water System Map
- Appendix B: Newberg Recycled Water Use Evaluation
- Appendix C: Source Expansion Assessment
- Appendix D: Water SDC Methodology
- Appendix E: Addendum - Riverfront Master Plan



SECTION 1

SECTION 1 INTRODUCTION AND EXISTING WATER SYSTEM

Introduction

The purpose of this Water Master Plan (WMP) is to perform an analysis of the City of Newberg's (City's) water system and:

- Document existing water system service area, facilities and operation
- Estimate future water requirements including potential water system expansion areas
- Identify deficiencies and recommend water facility improvements that correct deficiencies and provide for growth
- Update the City's capital improvement program (CIP)
- Evaluate the City's existing operation and maintenance (O&M) program
- Evaluate the City's existing system development charges (SDCs)

In order to identify system deficiencies, existing water infrastructure inventoried in this section will be assessed based on estimated existing and future water needs developed in **Section 2** and water system performance criteria described in **Section 3**. The results of this analysis are presented in **Sections 4 and 5**. **Section 7** identifies improvement projects to mitigate existing and projected future deficiencies and provide for system expansion including a prioritized CIP and a discussion of CIP funding including an updated SDC methodology. **Section 6** presents the O & M evaluation. The planning and analysis efforts presented in this WMP are intended to provide the City with the information needed to inform long-term water infrastructure decisions.

This plan complies with water system master planning requirements established under Oregon Administrative Rules (OAR) for Public Water Systems, Chapter 333, Division 61.

Water System Background

The City owns and operates a public water system that supplies potable water to all residents, businesses and public institutions within the city limits. This section describes the water service area and inventories the City's water system facilities including existing supply sources, pressure zones, finished-water storage reservoirs, pump stations and distribution system piping.

Plate 1 in Appendix A illustrates the City's water system service area limits, water system facilities and distribution system piping. The water system schematic in **Figure 1-2** at the end of this section shows the existing configuration of water system facilities and pressure zones.

Springs Water System

Historically Newberg maintained four natural spring sources north of the city center which were part of the City's original water system at the start of the 20th century. Following the development of the City's well field, the springs were disconnected from the City distribution system and used to supply only the "springs" or "riparian" customers nearby. Almost all of these springs customers are outside of the city limits and urban growth boundary (UGB).

In 2015, the City divested from the Springs Water System. Ownership, operation and maintenance of springs sources, including Snider, Skelton, Atkinson and Oliver Springs as well as treatment, piping, water rights and easements were transferred to the Chehalem Spring's Water Association, established by the property owners who receive water from the springs for the purpose of operating the springs system. The City retains ownership of parcels where the springs are located which are leased to the Chehalem Spring's Water Association. Analysis of springs system sources, facilities and service areas are not included in this Master Plan.

Water Service Area

The City's current water service area includes all properties within the city limits as well as a small number of customers outside the city limits and a number of independent water districts outside the city. Current customers outside the city limits include; residents of Aspen Estates along Highway 240 west of Chehalem Creek, properties along Highway 99W east of Providence Hospital including the Rex Hill Winery. Private water systems supplied by the City of Newberg include; Chehalem Terrace Water Company, Chehalem Valley Water Association, Northwest Newberg Water Association, Sam Whitney Water District, Sunny Acres Water District and West Sheridan Street Water Association. Portions of these private water systems are within the UGB and Urban Reserve Areas (URAs).

The future service area and the study area for this Master Plan includes all areas within the city limits and UGB. All customers of existing small water districts supplied by the City are also included in the Master Plan analysis. Newberg's municipal code prohibits City water service to new customers in private water systems outside the City. The existing and future service area boundaries are illustrated on **Figure 1-1** at the end of this section.

Supply Facilities

Well Field

The City draws its water supply from a well field located in Marion County farmland across the Willamette River from the City's Water Treatment Plant (WTP). The well field includes nine existing wells, five of which are currently active. Due to declining yields Well Nos. 1, 2 and 3 have been taken out of service. A ninth well was recently completed. Due to the close proximity of wells in the City's well field, nominal well capacities may be impacted by the

number and combination of wells in operation at the same time. Wells are operated by City staff in combinations which best meet the anticipated system demands for the day. All active wells, except Well 9, are equipped with variable frequency drives (VFDs) which adjust pump speed and well production based on the water level at the City’s finished water storage reservoirs. Active City well capacities in gallons per minute (gpm) are summarized in **Table 1-1**.

The well field lies within the Willamette River floodplain and was entirely submerged during the 1996 flood. Well 8 was constructed with mooring piles incorporated into the well house design to allow City staff to dock a boat at the well if needed in case of a flood. Well 8 is also the only existing City well with a transfer switch to allow well operation by a portable generator.

**Table 1-1
Well Capacity Summary**

Well	Year Constructed	Nominal Capacity (gpm)	
		Min	Max
4	1970	350	400
5	1980	400	425
6	1980	900	1,600
7	2001	1,000	1,700
8	2007 (pump upsized 2014)	1,700	2,300
9	2016	1,800	1,800
TOTAL	gpm	6,150	8,225
	mgd	8.9	11.8

Raw Water Transmission

Water is supplied from the well field to the WTP on the north side of the Willamette River through two large-diameter raw water transmission mains. The first main is a 1,900 foot long, 24-inch diameter cast iron main suspended from a decommissioned highway bridge. The 24-inch main has an approximate capacity of 10 million gallons per day (mgd) (7,000 gpm). The approaches to the former Highway 219 bridge have been demolished and the bridge is now owned and maintained by the City for the sole purpose of carrying the 24-inch water transmission main from the well field to the WTP. A second 30-inch diameter high density polyethylene (HDPE) transmission main, constructed downstream in 2006, carries water from the well field under the Willamette River to the WTP.

Water Treatment Plant

The City’s WTP, constructed in 1953, is located on the north bank of the Willamette River south of downtown Newberg within the fence of the WestRock mill. The WTP was expanded and upgraded in 1961, 1970, 1980, 1997 and 2006. The current WTP is a conventional filtration facility used to treat high levels of dissolved iron in the well source water. The plant has a nominal capacity of 9 mgd. According to City staff, operational capacity at the WTP is limited to approximately 8 mgd due to undersized piping between the raw water transmission mains and the settling basins.

The City’s distribution system and finished water storage reservoirs are supplied by four High Service Pumps which draw suction supply from the WTP clearwell. All four line shaft vertical turbine pumps are equipped with VFDs which adjust the pumping rate based on the clearwell water level. The four pumps have a total rated capacity of approximately 14.3 mgd. WTP High Service pumps and capacities are summarized in **Table 1-2**.

**Table 1-2
WTP High Service Pump Summary**

Pump No.	Install Year	Motor Hp	Manufacturer	Model	Capacity	
					gpm	mgd
1	2005	250	Flowserve	15EHM 3 Stage Vertical Turbine	2,800	4.0
2	2005	250	Flowserve	15EHM 3 Stage Vertical Turbine	2,800	4.0
3	1980	150	Byron Jackson	12MQH 5 Stage Vertical Turbine	1,300	1.9
4	2005	250	Flowserve	15EHM 3 Stage Vertical Turbine	2,800	4.0
TOTAL					9,700	13.9

Pressure Zones

The majority of Newberg’s existing water customers are served from Pressure Zone 1 which is supplied by gravity from the City’s three finished water storage reservoirs and from the WTP.

Residential customers along Knoll Drive north of Hillsdale Drive which are too high in elevation to receive adequate service pressure from Zone 1 are supplied constant pressure from the Oak Knoll Pump Station at an approximate hydraulic grade line (HGL) of 470 feet. For the purposes of this WMP, this area is referred to as Pressure Zone 2.

Storage Reservoirs

Newberg's water system has three reservoirs with a total combined storage capacity of approximately 12 million gallons (MG). All three reservoirs have an approximate overflow elevation of 403 feet. **Table 1-3** presents a summary of the City's existing storage reservoirs.

North Valley Reservoirs

North Valley Reservoir Nos. 1 and 2 are located outside of the UGB on the north side of North Valley Road west of Highway 219. The reservoirs share a single site which is fully fenced. Reservoir No. 1 is a 4 MG circular, hopper-bottom concrete tank with a domed roof constructed in approximately 1960. Reservoir No. 2 is a 4 MG, circular, prestressed concrete reservoir constructed around 1978.

Reservoir No. 2 is currently being seismically upgraded. Mixing systems are being added to both tanks to mitigate water age issues. Interior coating of both Reservoir No. 1 and 2 was also completed as part of the upgrade project.

Corral Creek Reservoir

The Corral Creek Reservoir is a 4-MG, circular, prestressed concrete reservoir constructed in 2003 on the eastside of the City's water system. This reservoir is equipped with an altitude valve.

Table 1-3
Reservoir Summary

Reservoir Name	Capacity (MG)	Overflow Elevation ² (ft)	Floor Elevation ² (ft)	Diameter (ft)	Type	Year Built
North Valley No. 1	4.0	402.60	376.71 (369) ¹	144	Concrete	1960
North Valley No. 2	4.0	402.69	372	151	Prestressed Concrete	1977
Corral Creek	4.0	402.5	368.85	138	Prestressed Concrete	2003

Note: 1. North Valley Reservoir No. 1 parentheses indicate floor elevation of hopper bottom.

2. Vertical datum is NGVD 1929.

Booster Pump Stations

The Oak Knoll Pump Station is the only booster pump station in the Newberg distribution system. Oak Knoll was installed in 2000 to provide constant pressure service to around 40 homes along Knoll Drive north of Hillsdale Drive at the northern edge of the existing water service area. Located at 3613 Ivy Drive, the package pump station houses three pumps with a total capacity of 1,260 gpm. The station includes low flow and peak demand pumps with approximate capacities of 10 gpm and 250 gpm respectively and one high capacity pump dedicated to providing fire flow at approximately 1,000 gpm. This station includes backup power generation which allows the station to function during temporary power losses, ensuring that adequate service pressures are maintained.

Distribution System

The City's finished water distribution system is composed of various pipe materials in sizes up to 24 inches in diameter. The total length of City-owned potable piping in the service area is approximately 56.4 miles. The City maintains significant lengths of pipes 2-inches in diameter and smaller. Pipe materials under 4-inch diameter are primarily copper, polyvinyl chloride (PVC) and galvanized steel. Larger diameter pipe materials are a mix of cast iron and ductile iron with approximately 80 feet of steel main where the distribution system crosses Highway 219. **Table 1-4** presents a summary of pipe lengths by diameter from the City's Geographic Information Systems (GIS) water utility mapping.

Table 1-4
Distribution System Pipe Summary

Pipe Diameter	Approximate Length (miles)
4-inch or less	5.3
6-inch	13.2
8-inch	23.3
10-inch	4.3
12-inch	6.0
14-inch	0.2
16-inch	0.5
18-inch	2.7
24-inch	0.9
Total Length	56.4

Metering

All customer water use is currently metered using advanced metering infrastructure (AMI). Meters at individual services transmit consumption readings which are collected monthly using a “drive-by” receiving antenna.

Non-potable Reuse System

In addition to potable water distribution, Newberg also maintains a non-potable “purple pipe” distribution system. Non-potable systems are generally intended for irrigation use or to provide process and cooling water for manufacturing applications where potable water quality is not required.

The Newberg non-potable system can be supplied from either the City’s Otis Springs source or reuse water from the Newberg Wastewater Treatment Plant (WWTP) effluent. Otis Springs is located east of the City on the north side of Highway 99W. It produces approximately 300 gpm which is pumped through a 10-inch diameter non-potable main along Highway 99W southwest to a pond at the Chehalem Glenn Golf Course. Otis Springs’ pumps operate based on the water level at the golf course pond and production is metered at both the springs and golf course.

Installed in 2008, a pressurized membrane filtration system provides approximately 350,000 gallons per day of treated WWTP effluent (reuse water) to the golf course irrigation system. Reuse water is supplied from the south end of the course through 10-inch diameter reuse piping and meter installed along Wilsonville Road.

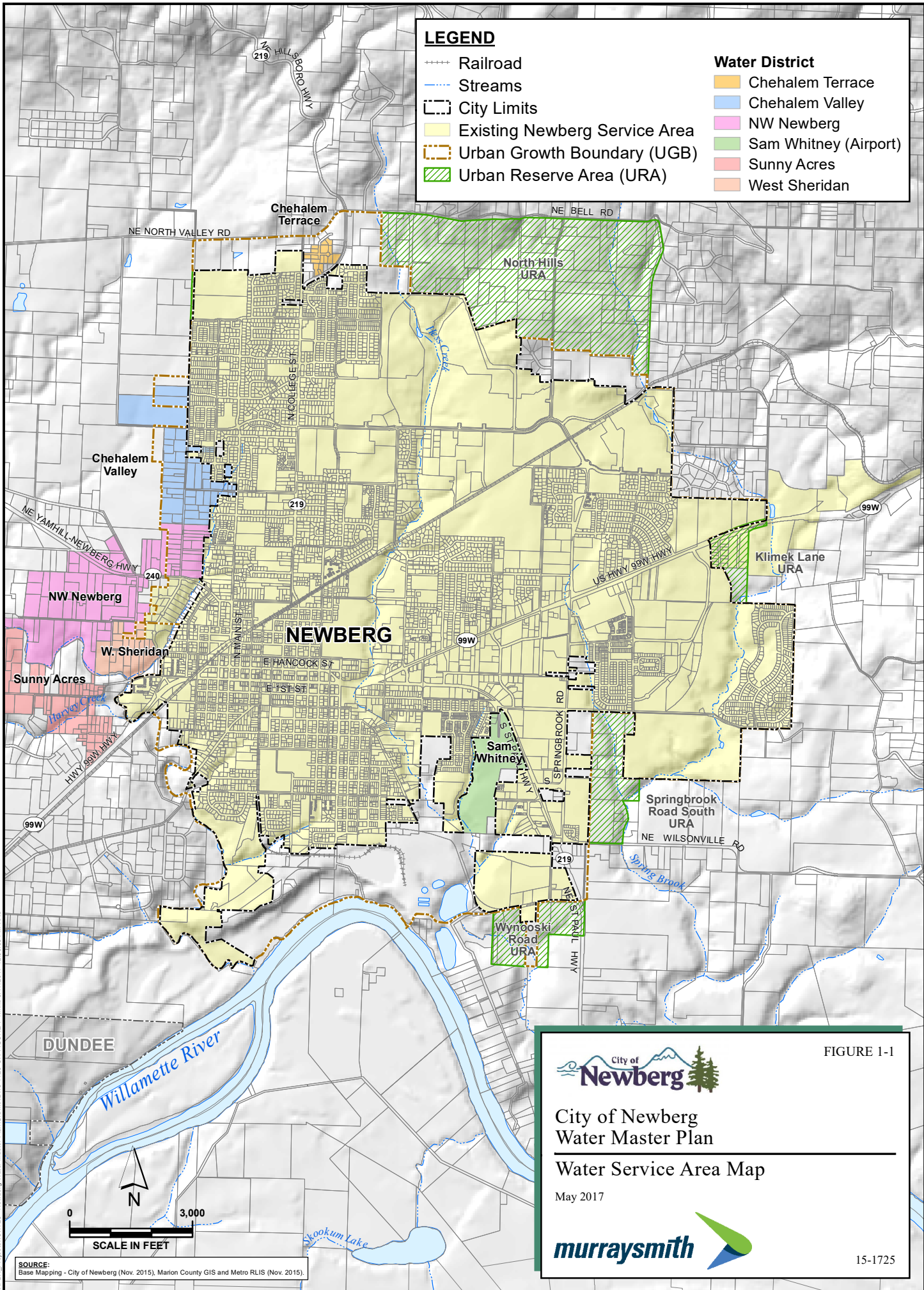
The publicly-owned golf course is the only existing customer of the City’s reuse system. Reuse pipes have been installed in parallel with other infrastructure and road projects at various locations within the Newberg water service area. However, the majority these non-potable mains are isolated pending future opportunities to connect and expand the reuse system. Evaluation of the City’s non-potable reuse system and an analysis of potential customers and future expansion is documented in **Appendix B**.

SCADA System

Newberg’s Supervisory Control and Data Acquisition (SCADA) system is used for remote operation of distribution system components as well as system performance monitoring and recording. Remote telemetry units (RTUs) at the well field, all reservoirs, the Oak Knoll Pump Station and Otis Springs transmit operating information and water levels to the WTP where City staff are able to view the status of the water system and make operational adjustments as required.

LEGEND

++++ Railroad	Water District
--- Streams	Chehalem Terrace
--- City Limits	Chehalem Valley
Existing Newberg Service Area	NW Newberg
Urban Growth Boundary (UGB)	Sam Whitney (Airport)
Urban Reserve Area (URA)	Sunny Acres
	West Sheridan



SOURCE:
Base Mapping - City of Newberg (Nov. 2015), Marion County GIS and Metro RLIS (Nov. 2015)

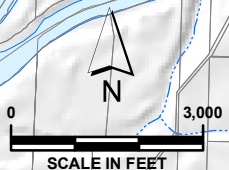
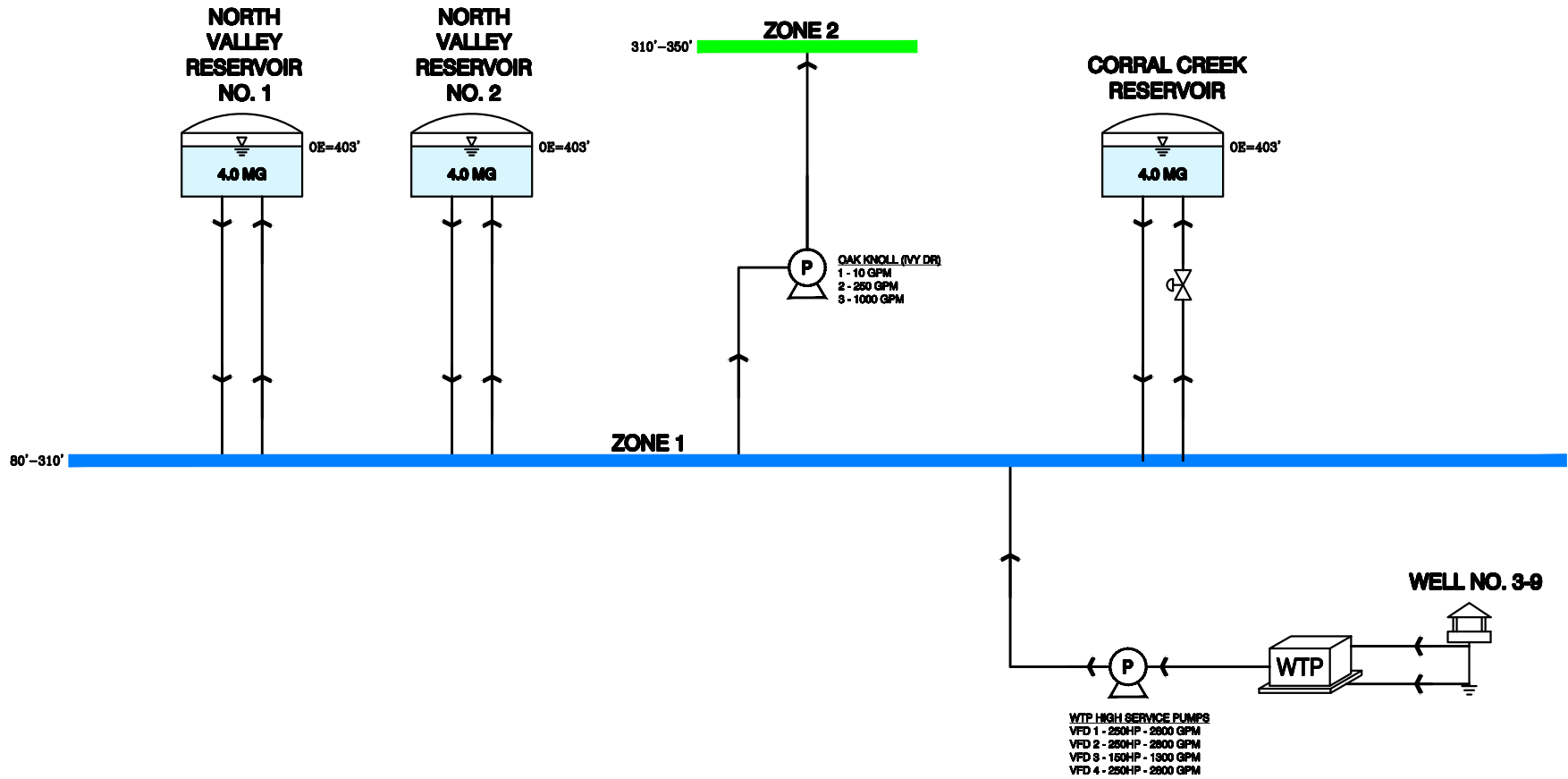


FIGURE 1-1

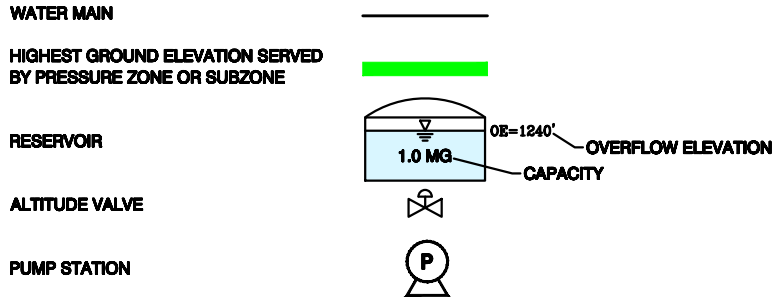
City of Newberg
 Water Master Plan
 Water Service Area Map
 May 2017

15-1725

G:\PDX_Projects\151725 - Newberg Water Master Plan\GIS\MXD\15-1725-OR-FIGURE 1-1.mxd 5/17/2017 12:59:08 PM HAS



LEGEND



ABBREVIATIONS

EL	ELEVATION
GPM	GALLONS PER MINUTE
HP	HORSEPOWER
MG	MILLION GALLONS
OE	OVERFLOW ELEVATION
PRV	PRESSURE REDUCING VALVE
PS	PUMP STATION
VFD	VARIABLE FREQUENCY (SPEED) DRIVE



FIGURE 1-2

CITY OF NEWBERG

EXISTING WATER SYSTEM SCHEMATIC

May 2017





SECTION 2

SECTION 2

WATER REQUIREMENTS

This section presents existing and projected future water demands for the City of Newberg's (City's) water service area. Demand forecasts are developed from future population projections and historical water consumption and production records.

Planning Period

The planning period for this Water Master Plan (WMP) is 20 years, through the year 2035, consistent with Oregon Administrative Rule (OAR) requirements for Water System Master Plans (OAR 333-061).

Service Area

Existing

As presented in **Section 1 Figure 1-1**, the City's current water service area includes all properties within the city limits, a small number of customers outside the city limits and six independent water districts adjacent to the city limits. Private water systems supplied by the City of Newberg include: Chehalem Terrace Water Company, Chehalem Valley Water Association, Northwest Newberg Water Association, Sam Whitney Water District, Sunny Acres Water District and West Sheridan Street Water Association. Portions of these private water systems are within the City's Urban Growth Boundary (UGB) and Urban Reserve Areas (URAs).

Future

The future service area and the study area for this WMP includes all areas within the city limits and UGB. Analysis does not include all of the City's URAs as these are anticipated to develop outside of the 20-year planning horizon. A high level estimate of ultimate water demand in the City's North Hills URA is included in this section as this area's anticipated future growth impacts the sizing of a proposed storage reservoir. The proposed reservoir is discussed in more detail in **Section 5**.

Customers of existing water districts supplied by the City are also included in the WMP demand analysis. It is assumed that these Districts will continue to operate independent distribution systems. Newberg's municipal code prohibits City water service to new customers in private water systems outside the City thus no growth is anticipated for these Districts.

Historical Population

Newberg currently supplies water to approximately 22,900 residents. Current and historical population estimates for Newberg are taken from the Portland State University Population Research Center's (PSU PRC) *2012 Population Forecasts for Yamhill County, its Cities and*

Unincorporated Area 2011 to 2035. This report was adopted by Yamhill County and can be relied upon by the City for planning purposes per OAR 660-032-0040. Historical population estimates are summarized in **Table 2-1**.

Historical Water Demand

Water demand refers to all potable water required by the system including residential, commercial, industrial and institutional uses. The City of Newberg also maintains a non-potable water reuse system which is described in more detail in **Appendix B**. Potable water demands are described using three water use metrics, average daily demand (ADD), maximum day demand (MDD) and peak hour demand (PHD). Each of these metrics are stated in gallons per unit of time such as million gallons per day (mgd) and in gallons per capita per day (gpcd). ADD is the total annual water volume used system-wide divided by 365 days per year. MDD is the largest 24-hour water volume for a given year. In western Oregon, MDD usually occurs each year between July 1st and September 30th. PHD is estimated as the largest hour of demand on the maximum water use day.

Water demand can be calculated using either water consumption or water production data. Water consumption data is taken from the City's customer billing records and includes all revenue metered uses. Water production is measured as the water supplied to the distribution system from the City's Water Treatment Plant (WTP) plus the water volume supplied from distribution storage. Water production includes unaccounted-for water like water loss through minor leaks and unmetered, non-revenue uses, such as, hydrant flushing.

For the purposes of this WMP, water production data is used to calculate total water demand in order to account for all water uses including those which are not metered by the City. 2015 customer consumption and billing records are used to distribute current water demands throughout the water system hydraulic model, discussed in **Section 5**.

The historical ratios of ADD:MDD and MDD:PHD are used to estimate future maximum day and peak hour demands. Based on historical system-wide demands, the ratio of ADD:MDD is approximately 2.0. The ratio of MDD:PHD is approximately 1.7 consistent with similar regional water providers. **Table 2-1** summarizes the City's current system-wide water demand based on water production data.

Table 2-1
Historical Water Demand Summary
See Note 1

Year	Population	ADD		MDD	
		(mgd)	(gpcd)	(mgd)	(gpcd)
2010	22,110	2.23	101	4.84	219
2011	22,230	2.24	101	4.42	199
2012	22,300	2.27	102	4.76	213
2013	22,580	2.24	99	4.39	194
2014	22,765	2.31	101	4.43	194
2015	22,900	2.38	104	4.75	207

Water Demand by Pressure Zone

As described in Section 1, water systems are divided into pressure zones in order to provide adequate service pressure to customers at different elevations. Each pressure zone is served by specific facilities, such as, reservoirs or pump stations and related piping which supply pressure to customers. In order to assess the adequacy of these facilities, it is necessary to estimate demand in each pressure zone. The majority of Newberg water customers are part of Pressure Zone 1 served by gravity from the City’s WTP and three water storage reservoirs. Approximately 40 residential customers in Pressure Zone 2 are supplied constant pressure service from the Oak Knoll Pump Station. Current water demand is distributed between the City’s two pressure zones based on metered water consumption from 2015 billing records as summarized in **Table 2-2**.

Table 2-2
Current Water Demand by Pressure Zone

Pressure Zone	2015 ADD (mgd)
1	2.36
2	0.02
System-wide Total	2.38

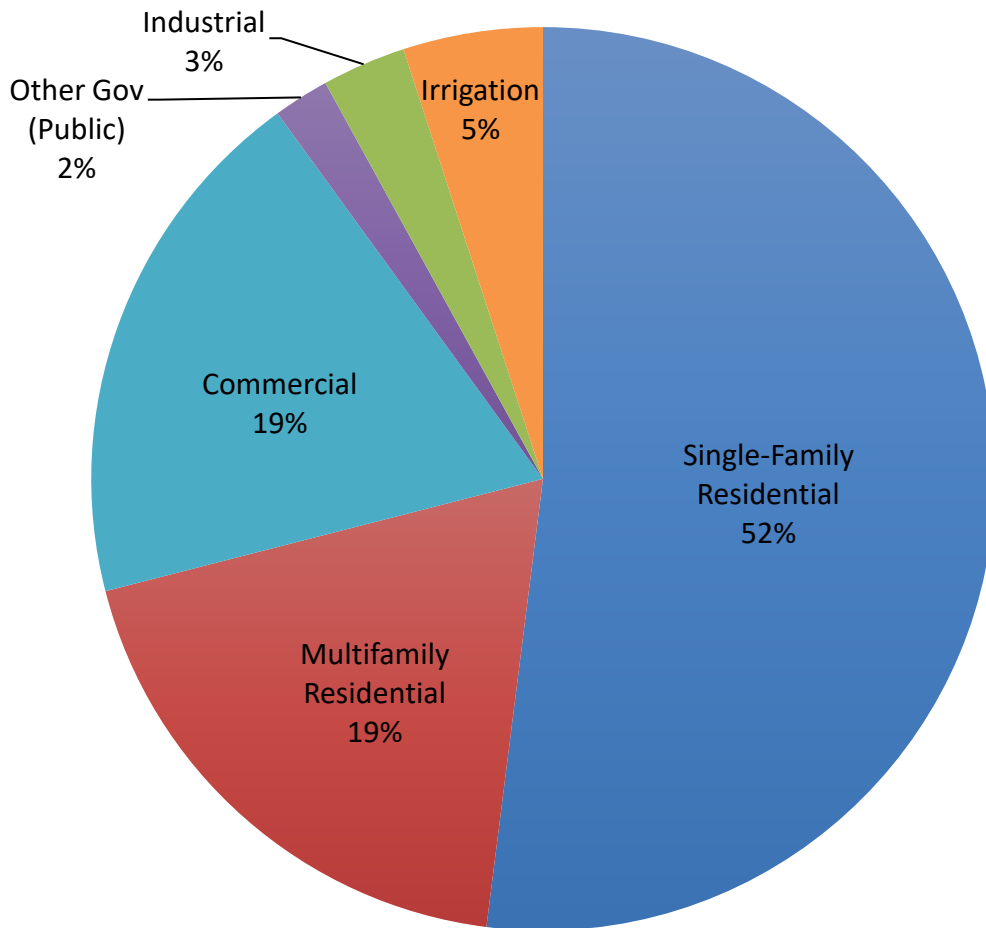
Water Consumption by Customer Type

The City’s water utility billing records maintain six primary customer types; Single-Family, Multifamily, Commercial, Industrial, Other Gov (Public) and Irrigation. The Other Gov customer type includes a wide variety of public facilities including schools, parks and community centers. Irrigation consumption includes irrigation services supplied from the City’s drinking water system and does not include irrigation water provided by the non-potable reuse system which is discussed in **Appendix B**. A seventh customer type, “Outside” includes all services outside the current city limits. Based on their meter size, the water demand of these Outside services are assumed to

correlate with the City’s Single-Family (3/4- and 1-inch meters) and Commercial (2-inch and larger meters) customer types.

Percentages of current water consumption by customer type are calculated based on 2015 City water billing records. As illustrated on **Figure 2-1**, the majority of water consumption in Newberg, approximately 71 percent, is by residential customers.

Figure 2-1
Current Annual Water Consumption by Customer Type



Future Population and Water Demand Forecast

Estimates of future growth and related water demand within the Newberg UGB are developed using the best available information for the City’s service area including adopted population forecasts from the PSU PRC’s *2012 Population Forecasts for Yamhill County, its Cities and Unincorporated Areas 2011 to 2035* report and historical per capita water demands presented in **Table 2-1**. Future system-wide water demands are forecast at 5-, 10- and 20-years.

Historical per capita average daily water demands (ADD) range from 99 to 104 gpcd. An average per capita demand of 101 gpcd is used to forecast ADD based on population projections. Based on 2010 US Census data the average number of persons per household in Newberg is approximately 2.66.

Future MDD is projected from estimated future ADD based on the current average ratio of MDD:ADD, also referred to as a peaking factor. From current water demand data shown in **Table 2-1**, the MDD:ADD peaking factor for the Newberg system is approximately 2.0. Future PHD is similarly projected from future MDD, the PHD:MDD peaking factor is approximately 1.7. Forecasted water demands are summarized in **Table 2-3**.

Table 2-3
Future Water Demand Summary
See Note 1

Year	Forecast Population	ADD (mgd)	MDD (mgd)	PHD (mgd)
2020	28,250	2.86	5.72	9.72
2025	32,213	3.26	6.52	11.08
2035	38,490	3.89	7.78	13.23

Future Demand by Pressure Zone

Forecasted future water demands are allocated to existing and proposed future pressure zones based on an ideal service pressure range of 40 to 80 pounds per square inch (psi) and existing ground elevations in potential water service expansion areas within the UGB and North Hills URA. Existing and proposed pressure zone boundaries for the study area are illustrated on **Plate 1** in **Appendix A**. Estimated future water demands by pressure zone are summarized in **Table 2-4**.

The City’s existing Pressure Zone 1 provides service up to approximately 310 feet elevation. As properties within the UGB and above Zone 1 service elevations begin to develop, a higher-elevation Pressure Zone 3 will be required northeast of the city center. For the purposes of this WMP, it is assumed that the proposed Zone 3 would serve customers between 310 and 440 feet elevation ultimately including most of the North Hills URA. Properties in the North Hills URA above 440 feet are assumed to be served from a future Zone 4 which is not analyzed for the purposes of this Master Plan. The City has purchased property north of Bell Road near the intersection with Zimri Drive as a future storage reservoir site to serve higher-elevation development within the UGB and North Hills URA.

It is assumed that Zone 2 customers will continue to be served by constant pressure through the 20-year planning horizon. Beyond the 20-year planning horizon, Zone 2 customers may ultimately be served by gravity from the proposed Bell Road Reservoir, as development warrants.

Proposed Zone 2 Demand

The City anticipates demands in Zone 2 to expand by approximately 171 gallons per minute (gpm) (0.25 mgd) with the addition of the existing North Valley Friends Church, the proposed Veritas School and a proposed 11-lot single-family subdivision at 4016 N College Street (Rourke Property). Additional Zone 2 demand is taken from analysis presented by AKS Engineering & Forestry (December 2015) in support of the Rourke Property subdivision. Completion of these additional Zone 2 customer connections is assumed to occur within the next 5 years.

Proposed Zone 3 Demand

As shown on **Plate 1** in **Appendix A**, within the 20-year planning horizon, the proposed Zone 3 would supply a small portion of the Springbrook development along Aspen Way within the current city limits and UGB. Ultimately, proposed Zone 3 would serve most future customers in the North Hills URA which is anticipated to develop beyond the 20-year planning horizon. Future customers within the North Hills URA above approximately 440-foot elevation are assumed to be served by a future Zone 4.

Future water demand within the proposed 20-year Zone 3 boundary is estimated based on land use classifications from the Yamhill County Comprehensive Plan, City zoning for similar adjacent properties, the *Springbrook Master Plan* and per capita water demands presented earlier in this section. Timeframes for potential development were estimated in 5-year blocks for each parcel within the UGB based on their proximity to existing development and infrastructure as well as property ownership.

Table 2-4
Future Water Demand by Pressure Zone
See Note 1

Forecast Water Demand (mgd)						
Zone	5-Year		10-Year		20-Year	
	ADD	MDD	ADD	MDD	ADD	MDD
1	2.58	5.16	2.97	5.93	3.59	7.18
2	0.27	0.54	0.27	0.54	0.27	0.54
3	0.01	0.02	0.02	0.05	0.03	0.06
Total	2.86	5.72	3.26	6.52	3.89	7.78

North Hills URA Demand

A high level estimate of ultimate water demand in the City's North Hills URA is included in this section as this area's anticipated future growth impacts the sizing of the proposed Bell Road storage reservoir discussed in more detail in **Section 5**. The North Hills URA is anticipated to develop beyond the 20-year planning horizon. Customers in the North Hills URA below approximately 310 feet elevation will be served by extending existing Zone 1 distribution mains.

Customers above 310 feet and below approximately 440 feet elevation will be served from proposed Zone 3. Customers above approximately 440 feet are assumed to be served by a future Zone 4.

Future water demand in the City’s North Hills URA is estimated at 11 persons per acre based on the City’s 2009 URA analysis presented to the Oregon Land Conservation and Development Commission (LCDC) and current water demand per capita presented earlier in this section. Estimated demand beyond 20 years for the North Hills URA is summarized in **Table 2-5**.

**Table 2-5
North Hills URA Future Water Demand**

Future Pressure Zone	Land Area (acres)	Projected Growth beyond 20-years		
		Population (at 11 persons/acre)	Water Demand (mgd)	
			ADD	MDD
1	27.5	303	0.03	0.06
3	272.2	2,994	0.30	0.60
4	100.7	1,108	0.11	0.22



SECTION 3

PLANNING AND ANALYSIS CRITERIA

This section presents the planning and analysis criteria used to analyze performance of the City of Newberg (City) water system. Criteria are presented for water supply, distribution system piping, service pressures, storage and pumping facilities. Recommended water needs for emergency fire suppression are also presented. These criteria are used in conjunction with the water demand forecasts developed in **Section 2** to complete analysis of the City's water source presented in **Section 4** and distribution system presented in **Section 5**.

The recommendations of this plan are based on the following performance guidelines, which have been developed through a review of State requirements, American Water Works Association (AWWA) acceptable practice guidelines, *Ten States Standards* and the *Washington Water System Design Manual*. These performance criteria are consistent with the City's 2015 *Public Works Design & Construction Standards*.

Water Supply Capacity

As described in **Section 1**, the City draws its supply from a well field across the Willamette River from the Newberg water service area and the Water Treatment Plant (WTP). Water is supplied from the well field to the WTP through two large-diameter raw water transmission mains, one suspended from a decommissioned highway bridge and the other buried beneath the riverbed. At the WTP, raw water is treated through conventional filtration to remove high levels of dissolved iron in the well source water. After treatment, finished water is pumped by the High Service Pumps from the WTP clearwell through the distribution system to storage reservoirs. The City's overall supply capacity is impacted by each of these components; water source, raw water transmission (river crossings), water treatment plant and high service pumps.

Normal Operating Supply

Under normal operating conditions, the City should plan for adequate firm capacity to supply maximum day demand (MDD) from the well field to the WTP and distribution storage. Firm capacity is defined as total capacity with the largest facility out of service. Supply components are evaluated at firm capacity to provide for system redundancy. Redundancy allows components to be taken out of service, as needed, for both unscheduled repairs and regular maintenance. For the City's supply components firm capacity criteria are as follows. The City's total supply capacity is limited by the source, transmission or treatment component with the smallest firm capacity.

- **Source** – MDD available with the largest well out of service
- **Raw water transmission (river crossings)** – minimum of two transmission main river crossings, MDD available with one crossing out of service

- **Water Treatment Plant** – minimum of two parallel treatment trains, MDD available with one train out of service
- **High Service Pumps** – minimum of three pumps, MDD available with the largest pump out of service

Redundant Supply

The well field is the City's only existing source. This source may be vulnerable to flooding or other natural disasters. Existing raw water transmission mains across the Willamette River from the well field to treatment and customers may also be vulnerable to ground movement, seismic activity or other natural disasters. Due to the potential vulnerability of the existing supply system, the City should plan for adequate redundant supply capacity to provide one day of wintertime average water demand. It is assumed that new redundant sources would preferably be located on the north side of the Willamette River.

Distribution System Capacity and Service Pressures

Pressure Zone Configuration

Water distribution systems are separated by ground elevation into pressure zones in order to provide service pressures within an acceptable range to all customers. Typically, water from a reservoir will serve customers by gravity within a specified range of ground elevations so as to maintain acceptable minimum and maximum water pressures at each individual service connection. When it is not feasible or practical to have a separate reservoir for each pressure zone, pump stations or pressure reducing valves (PRVs) are used to serve customers in higher or lower pressure zones respectively from a single reservoir.

Currently, the majority of Newberg water customers are served by a single pressure zone. It is anticipated that future growth at higher elevations in northeast Newberg will require development of additional pressure zones. All existing and future pressure zones should incorporate at least one of the following strategies to promote service reliability and redundancy:

- Gravity storage within the pressure zone.
- Standby pump station power.
- Multiple pump stations supplying the pressure zone.
- A PRV connection to an upper pressure zone configured for emergency and supplemental fire flow supply. These valves should be equipped with pressure sustaining features to prevent under-pressurization of the upper pressure zone.

Normal Service Pressure

The desired service pressure range under average daily demand (ADD) and normal operating conditions is 40 to 80 pounds per square inch (psi) consistent with the City's 2015 *Public Works Design and Construction Standards*. Whenever feasible, it is desirable to achieve the 40 psi lower limit at the highest fixture within a structure. The maximum 80 psi service pressure limit is required by the *Oregon Plumbing Specialty Code (OPSC) 608.2*. Conformance to this pressure range may not always be possible or practical due to topographical relief and existing system configurations. Where mainline pressures exceed 80 psi, service connections should be equipped with individual PRVs.

The distribution system should be capable of supplying the peak hourly demand (PHD) while maintaining service pressures of not less than 75 percent of normal system pressures.

Service Pressure in an Emergency

During a fire flow event or emergency, the minimum service pressure is 20 psi as required by Oregon Health Authority, Drinking Water Services (OHA) and OAR 333-061-0025(7). The system should be capable of providing fire flow capacity while simultaneously delivering MDD and maintaining 20 psi throughout the distribution system. The system should meet this criterion with operational storage in the City's reservoirs depleted.

Distribution Main Criteria

In general, distribution system main flow velocities should not exceed 8 feet per second (fps) under fire flow conditions and 5 fps under normal demand conditions. Per the City's 2015 *Public Works Design and Construction Standards*, Class 52 ductile iron is the City's standard water main pipe material. The minimum pipe size is 8-inch diameter for new permanently dead ended residential water mains and primary feeder mains in residential areas.

Water Quality

In Oregon, drinking water quality standards for 95 primary and 12 secondary contaminants are established under the Oregon Drinking Water Quality Act (OAR 333-061) which includes implementation of national drinking water quality standards. To maintain public health, each contaminant has either an established maximum contaminant level (MCL) or a recommended treatment technique.

Source Water

Potential for pathogens in groundwater sources like the City's wells are regulated by the Groundwater Rule (GWR). The City's existing wells have high levels of dissolved iron in the water. Iron is a secondary contaminant which causes metallic taste, discoloration, sediment and staining but is not a threat to human health. Dissolved iron is removed from the source

water at the City's WTP. Other regulated contaminants are monitored as required by the State's drinking water quality standards.

Distribution System

There are three drinking water quality standards and potential contaminants that may be exasperated or originate in the distribution system. Specifically, microbial contaminants (Total Coliform Rule), lead and copper (Lead and Copper Rule) and disinfection byproducts (Disinfectants and Disinfection Byproducts Rule).

Total Coliform Rule

There are a variety of bacteria, parasites, and viruses which can cause health problems when ingested. Testing water for each of these germs would be difficult and expensive. Instead, total coliform levels are measured. The presence of any coliforms in the drinking water suggests that there may be disease-causing agents in the water also. A positive coliform sample may indicate that the water treatment system isn't working properly or that there is a problem in the distribution system. Although many types of coliform bacteria are harmless, some can cause gastroenteritis including diarrhea, cramps, nausea and vomiting. This is not usually serious for a healthy person, but it can lead to more serious health problems for people with weakened immune systems.

The Total Coliform Rule applies to all public water systems. Total coliforms include both fecal coliforms and *E. coli*. Compliance with the MCL is based initially on the presence or absence of total coliforms in a sample, then a focus on the presence or absence of *E.coli*. For Newberg, the MCL is exceeded if more than five percent of the 30 required monthly samples have total coliforms present. A water system must collect a set of repeat samples for each positive total coliform result and have it analyzed for total coliforms and *E.coli*.

Lead and Copper and Corrosion Control

Lead and copper enter drinking water primarily through corrosion of plumbing materials most commonly caused by a chemical reaction with the water which may be due to dissolved oxygen, low pH or low mineral content. Exposure to lead and copper may cause health problems ranging from gastroenteritis to brain damage. In 1991, the national Lead and Copper Rule (LCR) established action levels for lead and copper concentrations in drinking water. Under the Oregon Drinking Water Quality Act, water utilities are required to implement optimal corrosion control treatment that minimizes the lead and copper concentrations at customers' taps, while ensuring that the treatment efforts do not cause the water system to violate other existing water regulations. It should be noted that an update to the LCR is currently being considered, though implications to the City's water system are anticipated to be minimal.

Utilities are required to conduct monitoring for lead and copper from taps in customers' homes. Samples are currently required to be taken every three years at 30 sampling sites. The

action level for either compound is exceeded when, in a given monitoring period, more than 10 percent of the samples are greater than the action level.

Disinfectants and Disinfection Byproducts (DBP) Rule

DBPs form when disinfectants, like chlorine, used to control pathogens in drinking water react with naturally occurring materials in source water. DBPs have been associated with increased cancer risk. The City is required to sample four locations in the distribution system on a quarterly basis.

Storage Volume

Water storage facilities are typically provided for three purposes: operational storage, fire storage, and emergency storage. A brief discussion of each storage element is provided below. Recommended storage volume is the sum of these three components. Adequate storage capacity must be provided for each pressure zone which is supplied by gravity. Storage volume for pressure zones served through pressure reducing valves (PRVs) or by constant pressure pump stations is provided in the upstream pressure zone supplying the PRV or pump station.

Operational Storage

Operational storage is the volume of water needed to meet water system demands in excess of delivery capacity from the WTP to system reservoirs under PHD conditions. Operational storage capacity is evaluated based on the equalizing storage method from the Washington State Department of Health's *Water System Design Manual* (December 2009). This method defines minimum storage as the volume required to meet PHD for 2.5 hours with all non-emergency pumps serving the zone at full capacity.

Fire Storage

Fire storage should be provided to meet the single most severe fire flow demand within each zone. The fire storage volume is determined by multiplying the recommended fire flow rate by the expected duration of that flow consistent with the 2014 *Oregon Fire Code*. Specific fire flow and duration recommendations are discussed later in this section.

Emergency Storage

Emergency storage is provided to supply water from storage during emergencies such as pipeline failures, equipment failures, power outages or natural disasters. The amount of emergency storage provided can be highly variable depending upon an assessment of risk and the desired degree of system reliability. Provisions for emergency storage in other systems vary from none to a volume that would supply a maximum day demand or higher. Newberg has a single supply source from the City's well field and WTP which may become temporarily unavailable in the event of a major transmission main break or natural disaster.

Due to this potential vulnerability, the City's emergency storage criterion is 100 percent of MDD.

Pump Station Capacity

Pumping capacity requirements vary depending on how much storage is available, the number of pumping facilities serving a particular pressure zone, and the zone's maximum fire flow requirement. Pumping recommendations are based on firm capacity which is defined as a pump station's capacity with the largest pump out of service.

Pump Station supplying Pressure Zone with Gravity Storage

For pump stations supplying pressure zones with gravity storage available the station must have adequate firm capacity to supply MDD for the zone.

Pump Station supplying Constant Pressure to Zone

Although it is desirable to serve water system customers by gravity from storage, constructing and maintaining a reservoir for a small group of customers may be prohibitively expensive and lead to water quality issues associated with slow reservoir turnover during low demand times. Constant pressure pump stations supply a pressure zone without the benefit of storage and are commonly used to serve customers at the highest elevations in a water service area where only an elevated reservoir would be capable of providing the necessary head to achieve adequate service pressures by gravity. Pump stations supplying constant pressure service should have firm pumping capacity to meet PHD while simultaneously supplying the largest fire flow demand in the zone. Constant pressure pump stations are only recommended for areas with a small number of customers and low water demand with limited potential for future looping with adjacent pressure zones.

Standby Power

Standby power facilities are needed for constant pressure stations and for pump stations serving pressure zones with inadequate emergency storage capacity. Standby power is typically provided in the form of an on-site backup generator sized to operate the pump station at firm capacity with automatic transfer switches and on-site fuel storage.

Fire Flow Recommendations

The amount of water recommended for fire suppression purposes is typically associated with the local building type or land use of a specific location within the distribution system. Fire flow recommendations are typically much greater in magnitude than the MDD in any local area. Adequate hydraulic capacity must be provided for these potentially large fire flow demands.

Fire protection within the current water service area is provided by the Newberg Fire Department or Tualatin Valley Fire and Rescue (TVFR). Fire flow requirements for

individual facilities are determined by the Fire Marshal consistent with the 2014 *Oregon Fire Code*. The City's 2015 *Public Works Design and Construction Standards* specify a distribution system design capacity of 4,500 gpm in commercial and industrial areas and 1,000 gpm in residential areas. A summary of fire flow for each land use type and approximate fire hydrant spacing is presented in **Table 3-1**.

**Table 3-1
Summary of Recommended Fire Flows**

Land Use Type (City zoning designations)	Fire Flow (gpm)	Duration (hours)	Average Fire Hydrant Spacing (feet)
Low Density Residential: (AR, R-1, SD/LDR)	1,000 ¹	2	500
Medium Density Residential: (R-2, SD/MRR)	1,500	2	500
High Density, Manufactured Dwelling and Professional Residential: (R-3, R-4, R-P)	2,000	2	450
Neighborhood Commercial: (C-1, SD/NC)	2,000	2	450
Community, Central Business District and Employment Commercial: (C-2, C-3, C-4, SD/E, SD/V)	3,000	3	400
Limited Industrial (M-1)	3,000	3	400
Light, Heavy and Airport Industrial: (M-2, M-3, M-4, AI)	4,500 ²	4	300
Institutional and Hospitality: (I, SD/H)	4,500 ²	4	300

Notes:

1. For homes over 3,600 square feet the 2014 *Oregon Fire Code* requires a minimum 1,500 gpm fire flow.
2. Maximum fire flow per 2015 *Public Works Design and Construction Standards* for commercial or industrial areas.

Summary

See Note 1

The criteria developed in this section are used in **Section 4** and **Section 5** to assess the supply and distribution system's ability to provide adequate water service under existing conditions and to guide improvements needed to provide service for future water needs. Planning criteria for the City's booster pump stations, distribution system, pressure zones, and storage facilities are summarized as follows:

- **Supply:** All supply components; source, transmission, treatment and high service pumps should be capable of providing MDD at firm capacity
- **Redundant Supply:** One day of wintertime average demand should be available preferably from a source on the north side of the Willamette River
- **Service Pressure:**
 - Normal range under ADD conditions: 40 to 80 psi
 - Maximum per *Oregon Plumbing Specialty Code*: 80 psi
 - Minimum under PHD conditions: 75 percent of normal range
 - Minimum under emergency or fire flow conditions per OHA requirements: 20 psi
- **Distribution Mains:**
 - Maximum velocity under normal operating conditions: 5 fps
 - Maximum velocity under emergency or fire flow conditions: 8 fps
- **Storage Volume:** Recommended storage volume capacity is the sum of the operational, fire and emergency storage volume components.
- **Pump Station Capacity:** Pump stations pumping to gravity storage facilities should have adequate firm capacity to provide MDD to the zone. Pump stations supplying constant pressure service without the benefit of storage should have firm pumping capacity to meet PHD while simultaneously supplying the largest fire flow demand in the pressure zone.
- **Fire Flow:** The distribution system should be capable of supplying the recommended fire flows while maintaining minimum residual pressures everywhere in the system of 20 psi.

SECTION 4

WATER SUPPLY ANALYSIS

This section presents an assessment of the City of Newberg's (City's) current water supply system, a summary of existing water rights and analysis of future supply development options. Although the City does not have an immediate need to develop additional source and treatment capacity to meet projected future water demands presented in **Section 2**. The City should consider development of water supply redundancy to address existing supply vulnerability and for long-term water system resiliency.

Existing Supply Assessment

Existing Groundwater Wells

Newberg's current water supply source consists of groundwater production wells located in the City's well field on the south side of the Willamette River, across the river from the City's water treatment plant (WTP). Currently five of the City's nine wells are in operation, and the new production Well 9 will be brought on-line in early 2017. The wells generally produce water that is high in iron, and clogging by iron-reducing bacteria has been observed. To combat clogging and maintain production capacity, the City performs scheduled redevelopment of the operational wells every seven to ten years. General observations of the condition and production capacities of the existing wells are discussed below.

Wells 1 and 2

Well 1 was constructed in 1948, and Well 2 was constructed in 1951. Each well is approximately 90 feet deep and consists of a 12-inch diameter steel casing and approximately 6 feet of perforations for the open interval. Other details of the construction, such as the seal are unknown. The tested capacity of Wells 1 and 2 was 1,500 gallons per minute (gpm) when they were constructed, and the capacity of the original pumping systems was reported to be 750 gpm. The performance history of each well is unknown. Declining yield and lack of improvement following repeated rehabilitation efforts led the City to remove the Wells 1 and 2 from operation in 2013 and 2012, respectively.

Well 3

Well 3 was constructed in 1964, and consists of an 18-inch diameter steel casing installed to a depth of 103 feet. The well has a bentonite sanitary seal from ground surface to a depth of 24 feet. The open interval consists of two sets of perforations totaling 27 feet in gravel and sand formation. The tested capacity of the well when initially constructed was 1,800 gpm with 9 feet of drawdown over a 12-hour period; however, it produced excessive sand when in operation. Because of sand production and declining yield, Well 3 was removed from operation in 1980.

Well 4

Well 4 was constructed in 1970 and consists of a 16-inch diameter production casing to a depth of 80 feet and a 14-inch diameter (nominal) screen assembly to a depth of 96 feet. The well was constructed with a 20-foot cement surface seal. The open interval consists of 10 feet of 250-slot (0.25-inch slot size) stainless steel wire-wrap screen in gravel and sand formation. The original tested capacity of the well was 1,300 gpm with 12 feet of drawdown over a 30-hour period. Despite the use of stainless steel well screen in its construction and lower iron concentrations than those observed at other City wells, Well 4 produces some sand during operation and has declined in capacity over its operational history. The most recent rehabilitation of the well, completed in 2014, resulted in minimal improvement to the Well 4 production capacity. The City continues to operate Well 4 as a supplemental supply well for the well field. Well 4 is equipped with a variable frequency drive (VFD) pump motor and currently produces between 350 and 400 gpm.

Well 5

Well 5 was constructed in 1980 and was originally tested at 1,800 gpm with 13 feet of drawdown over 24 hours. The well consists of a 16-inch diameter production casing to a depth of 64 feet and a 14-inch diameter (nominal) screen assembly from 56 to 88.5 feet. The well is constructed with a cement surface seal to a depth of 34 feet. The open interval consists of stainless steel screen from 64.5 to 82.5 feet and perforated steel casing from 83.5 to 86.5 feet in gravel and sand formation. Historically, Well 5 experienced a great deal of interference from pumping at Wells 1, 2, and 3, and the pumping water level consistently fell to the level of the pump intake during the summer. Under current operations Well 5 sees interference from pumping at Well 6 and, to a lesser extent, at Wells 7 and 8. Well 5 has declined in capacity over its operational history. The most recent rehabilitation of this well, completed in 2014, resulted in minimal improvement. The City continues to operate Well 5 as a supplemental supply well for the well field. Well 5 is equipped with a VFD and currently produces between 400 and 425 gpm.

Well 6

Well 6 was constructed in 1980 and was originally tested at a rate of 2,575 gpm with 16 feet of drawdown after 24 hours. The well consists of 16-inch production casing to a depth of 70.5 feet, and a 14-inch (nominal) screen assembly from 62 feet to 95.5 feet. The well was constructed with a cement surface seal to a depth of 34 feet. The open interval consists of stainless steel wire-wrap screen between 70.5 feet and 90.5 feet in gravel and sand formation. The well has exhibited only minor reduction in capacity over its operational history and is scheduled for rehabilitation in 2016. Due to its central location in the well field, Well 6 sees interference from pumping at all of the operational wells. Well 6 is equipped with a VFD and is currently operated at rates between 900 and 1,600 gpm.

Well 7

Well 7 was constructed in 2000 and was originally tested at a rate of 1,500 gpm with 11 feet of drawdown over a 73 hour period. The well consists of a 16-inch diameter production casing to a depth of 65 feet and a 14-inch diameter (nominal) screen assembly between 56 feet and 89 feet. The well was constructed with a cement surface seal to a depth of 46 feet. The open interval consists of stainless steel wire-wrap screen from 67 to 77 feet and 83 to 89 feet in gravel and sand formation. The well has exhibited very minor reduction in capacity over its operational history, and the most recent well rehabilitation was completed in 2012. Well 7 sees interference from pumping at Wells 6 and 8. Well 7 is equipped with a VFD and is currently operated at rates between 1,000 and 1,700 gpm.

Well 8

Well 8 was constructed in 2006 and was originally tested at a rate of 4,000 gpm with 17 feet of drawdown over a 47 hour period. Based on the testing results and estimated interference, the recommended long-term design operational rate for the well was 2,500 gpm. The well consists of a 20-inch diameter production casing to a depth of 60 feet, and an 18-inch diameter (nominal) screen assembly. The well was constructed with a cement seal from 13 feet to 53 feet and bentonite from 4 feet to 13 feet. The open interval consists of stainless steel wire-wrap screen from 53 to 79 feet and 89 to 95 feet in gravel and sand formation. The well has exhibited very minor reduction in capacity over its operational history, and the most recent well rehabilitation was completed in 2013. Well 8 sees interference from pumping at Wells 6 and 7. Well 8 is equipped with a VFD and is currently operated at rates between 1,700 and 2,300 gpm.

Well 9

Well 9 was completed in 2016 with a design similar to Wells 7 and 8 and production capacity of approximately 1,800 gpm. It is anticipated that Well 9 will experience interference from pumping at the other operational wells, and pumping at Well 9 will likewise cause additional interference at the other operational wells. Well 9 is not equipped with a VFD. The operational pumping rates of the nearby wells are likely to be reduced as a result of the additional well interference and the non-varying production rate at Well 9.

Current Source Capacity Estimates

The total well field capacity is sensitive to changes in groundwater levels because the source aquifer beneath the well field is relatively shallow. In addition to the natural variation of the groundwater level of the aquifer due to changes in the Willamette River level (stage) and seasonal variations in precipitation (higher in the winter and lower in the summer), the groundwater level is also affected by the rate and volume of groundwater withdrawn from the City's well field.

At each production well there is a limited amount of available drawdown. Drawdown is the difference between the water level in the well and the top of the open interval of the well. During pumping, the available drawdown in the well decreases as the water level in the well falls. In addition, each pumping well creates a cone of drawdown that expands laterally away from the well as pumping continues. The decrease in available drawdown at a well caused by the pumping at another well is called interference. Interference is generally greater in wells that are constructed close together. Over longer periods of pumping, the cone of drawdown can expand to the lateral extent of the aquifer or to areas that are less productive, called boundaries, which can affect the rate of drawdown at the wells.

Available operational data indicate that the total well field capacity decreases after several days of continuous pumping due to the cumulative effects of interference and aquifer boundary conditions. For this reason, estimates of maximum source capacity were developed for one day and three days based on typical peak demand operational scenarios. Source capacity estimates include projections for Well 9, assuming a specific capacity similar to Well 7 and a non-varying flow rate of 1,800 gpm which is the capacity of the pump to be installed at Well 9. Firm source capacity estimates assume Well 8 is non-operational. Firm capacity is defined as total source capacity with the largest source, Well 8, out of service. Capacity estimates presented herein use conservative Willamette River stage levels to estimate available drawdown. More or less capacity may be available at any given time, depending on aquifer conditions and well performance. Estimates of maximum and firm source capacities, in million gallons per day (mgd), are presented in **Table 4-1**.

**Table 4-1
Source Capacity Estimates**

Aquifer Conditions	Capacity (mgd)			
	1-Day Max	1-Day Firm	3-Day Max	3-Day Firm
Summer (Low-Water)	11.6	8.5	9.0	8.4
Winter (High-Water)	11.8	8.5	10.6	8.5

Water Rights Summary

The City holds six municipal groundwater rights, including four water right certificates, one permit, and one groundwater registration. All of these water rights authorize use of groundwater from the City’s well field located in the alluvial aquifer adjacent to the Willamette River, and in combination authorize 35.16 cubic feet per second (cfs) or 15,779 gpm of water right appropriation rate. The majority of the City’s water rights are relatively free of water use conditions, and the City is in compliance with the few water use conditions that are attached to its water rights.

Groundwater Registration GR-63, the City's oldest water right, authorizes the use of 1,000 gpm (2.228 cfs) from each of the City's original two water supply wells, Well 1 and Well 2 (2,000 gpm in total). The City does not currently use these wells for supply because of diminished capacity and sand pumping.

Certificates 68620 and 82595 authorize a combined appropriation rate of 1,800 gpm (4.01 cfs) from Well 5. Although the production capacity of Well 5 was once sufficient for appropriating the full rate of these water rights, the capacity of Well 5 has declined over time to a current rate of 425 gpm.

Certificates 48100 and 82600, authorize an appropriation rate of 1,203 gpm (2.68 cfs) from Well 4 and 1,800 gpm (4.01 cfs) from Well 6, respectively. Similar to Well 5, the production capacity of Well 4, and to a lesser degree Well 6, have declined over time and the City can no longer appropriate the full water right rate from these wells.

The City's remaining water right, Permit G-17583 (formerly G-13876), authorizes the appropriation of up to 8,977 gpm (20.0 cfs) from six wells, including one collector well. Three of the six wells, Wells 7, 8, and 9, have been constructed and the City currently appropriates a combined total of up to 5,800 gpm from these wells under this permit (65% of the permit authorized rate). The City has an approved extension of time for this permit that extends the date to complete construction to October 1, 2054 and the date to apply water to full beneficial use to October 1, 2055. The City is authorized to appropriate up to 7,917 gpm (17.64 cfs) of the total permit authorized rate under its currently approved Water Management and Conservation Plan (WMCP). Access to additional rate under the permit, up to the maximum authorized rate, will require an update of the City's WMCP justifying the need for the additional rate. An updated WMCP must be submitted to the Oregon Water Resources Department (OWRD) by July 17, 2019 per a condition of the final order approving the City's current WMCP.

Table 4-2 provides an inventory of the City's water rights. **Table 4-3** provides a summary of the City's current well production capacity and the allocation of the City's water right capacity by well.

**Table 4-2
City of Newberg Water Rights for Use of Groundwater**

Application	Permit	Certificate or Registration	Aquifer	Associated Wells	Authorized Use	Priority Date	Authorized Rate	
							(cfs)	(gpm)
--	--	GR-63	Alluvial	Well 1 and Well 2	Municipal	9/30/1951 (Well 1) 5/31/1948 (Well 2)	2.228 (Well 1) 2.228 (Well 2)	1000 (Well 1) 1000 (Well 2)
G-5277	G-5277	68620	Alluvial	Well 5	Municipal	8/5/1970	3	1346
G-5254	G-5276	48100	Alluvial	Well 4	Municipal	7/20/1970	2.68	1203
G-9638	G-10067	82595	Alluvial	Well 5	Municipal	3/28/1980	1.01	453
G-9805	G-10068	82600	Alluvial	Well 6	Municipal	6/23/1980	4.01	1800
G-12515	G-17583		Alluvial	Well 7, 8 and 9 (existing) Well 10 and 11 (proposed) Collector Well (proposed)	Municipal	5/3/1991	20	8977

**Table 4-3
Allocation of Water Right Capacity - Groundwater**

Water Right ▶				GR-63	68620 T-4547 48104 Per. G-5277 App. G-5277	48100 Per. G-5276 App. G-5254	82595 Per. G-10067 App. G-9638	82600 Per. G-10068 App. G-9805	Per. G-13876 T-12202 (submitted 11/16/2015) T-9098 (approved) App. G-12515		
			Priority date	GR-54	9/30/1951 (Well 1) 5/31/1948 (Well 2)	8/5/1970	7/20/1970	3/28/1980	6/23/1980	5/3/1991	
			Certificate date		n/a	10/10/1995	5/25/1979	11/3/2006	11/3/2006	n/a	
			Appropriation Rate Authorized (cfs)		2.228 (Well 1) 2.228 (Well 2)	3.00	2.68	1.01	4.01	20.00	
			Appropriation Rate Authorized (gpm)		2,000	1,346	1,203	453	1,800	8,977	
			Authorized Type of Use		Municipal	Municipal	Municipal	Municipal	Municipal	Municipal	
Well Name	Well Log	Aquifer	Well Production Capacity ¹ (gpm)	Water Right Use Allocated by Well (gpm)						Well Production Capacity Allocated (gpm)	Well Production Capacity Remaining (gpm)
Well 1	MARI 191/194	Alluvial	0	0	n/a	n/a	n/a	n/a	n/a	0	0
Well 2	MARI 190/192	Alluvial	0	0	n/a	n/a	n/a	n/a	68620 and	0	0
Well 3	MARI 185	Alluvial	0	n/a	n/a	n/a	n/a	n/a	n/a	0	0
Well 4	MARI 188	Alluvial	400	n/a	n/a	400	n/a	n/a	n/a	400	0
Well 5	MARI 182	Alluvial	425	n/a	425	n/a	0	n/a	n/a	425	0
Well 6	MARI 181	Alluvial	1600	n/a	n/a	n/a	n/a	1600	n/a	1600	0
Well 7	YAMH 51996	Alluvial	1700	n/a	n/a	n/a	n/a	n/a	1700	1700	0
Well 8	MARI 59721	Alluvial	2300	n/a	n/a	n/a	n/a	n/a	2300	2300	0
Well 9	Proposed	Alluvial	0	n/a	n/a	n/a	n/a	n/a	0	0	0
Well 10	Proposed	Alluvial	0	n/a	n/a	n/a	n/a	n/a	0	0	0
Well 11	Proposed	Alluvial	0	n/a	n/a	n/a	n/a	n/a	0	0	0
Collector Well	Proposed	Alluvial	0	n/a	n/a	n/a	n/a	n/a	0	0	0
Appropriation Rate Allocated (gpm)				0	425	400	0	1600	4000	6425	0
Appropriation Rate Remaining (gpm)				2000	921	803	453	200	4977	9354	0

Notes:

¹ Based on Well Field Flow Combinations_2015 March.pdf

Transmission

Transmission of raw (untreated) water from the City's groundwater wells across the Willamette River to the WTP is provided by two parallel transmission mains.

The older 24-inch diameter cast iron main is suspended from a decommissioned highway bridge. The approaches to the former Highway 219 bridge have been demolished and the bridge is now owned and maintained by the City for the sole purpose of carrying the water transmission main from the well field to the WTP. The City does not have a formal maintenance or inspection program for the bridge structure. In 2016, a river bank failure occurred next to the bridge's northern end. The City is currently investigating any impact to the transmission main from this event and conducting an assessment of potential slope instability and mitigation strategies at the bridge crossing. The 24-inch bridge transmission main is assumed to be vulnerable to failure during a seismic event due to either potential failure of steel structural members in the existing bridge or slope instability.

A second 30-inch diameter high density polyethylene (HDPE) transmission main, constructed downstream of the bridge crossing in 2006, carries water from the well field under the Willamette River to the WTP. This crossing is considered more resistant to a seismic event due to the flexibility of the pipe material. Flexible joints, which allow slight pipe displacement during a seismic event were not incorporated into the pipeline design at either end of the river crossing. All existing fittings and joints are restrained.

Treatment

See Note 1

The City's existing WTP has a nominal capacity of 9 mgd. Overall plant capacity is currently limited by dual 12-inch diameter piping between the well field transmission mains and WTP settling basins. If the WTP is operated at 9 mgd, water flows from the dual 12-inch diameter mains into the settling basins at high velocity causing it to splash back over the settling basin wall. To mitigate this splash back and ensure proper mixing in the settling basin, the WTP is operated at a maximum capacity of approximately 8 mgd. The existing 8 mgd effective WTP capacity is adequate to meet projected demands of 7.78 mgd through the 20-year planning horizon.

Future Supply

As presented in **Section 3**, the City's current water supply system relies solely upon the well field source water piped across the Willamette River to treatment and customers. Both the well field and at least one transmission main may be vulnerable to flooding, ground movement, seismic activity or other natural disasters. Given these potential vulnerabilities it is recommended that the City assess redundant supply options on the north side of the Willamette River.

Any potential drinking water supply system has three primary components: source, transmission and treatment. Transmission must be provided for both raw water, from the

source to treatment and finished water, from treatment to storage and customers. For a water supply system to be feasible each of these three primary components must be analyzed for their capacity, location and cost. Potential sources are also evaluated for their water quality as this impacts the needed treatment. As illustrated in **Figure 4-1** at the end of this section, a fatal flaw at any one of these evaluation steps may lead to elimination of a proposed source as a feasible option.

Required Capacity

It is recommended that the City evaluate redundant supply sources based on a required capacity of one day of wintertime (non-peak) average daily demand. Based on historical water production records from the WTP, current wintertime average demand is approximately 2 mgd.

Groundwater Source Expansion Assessment

Several alternatives for groundwater source expansion were evaluated on the basis of favorable hydrogeology and the availability of water rights. A detailed discussion of the evaluation is provided in **Appendix C**, and the key outcomes are summarized below.

Hydrogeology

The four major geologic units present in the Newberg area (shown in **Appendix C, Figure 1**) were evaluated for potential to develop a new groundwater source:

1. The marine sediment unit was eliminated from further consideration for a new groundwater source because of poor water quality and low well yields.
2. The nature and distribution of Columbia River Basalt Group (CRBG) aquifers are not well characterized in the Newberg area. The CRBG aquifers outside and in the northern part of the City, where known to be present, are compartmentalized and have low to medium yields and declining water levels. The presence, thickness, and productivity of the CRBG in the southern portion of the City is unknown, and exploration would require a significant investment. The CRBG aquifers were eliminated from further consideration for a new groundwater source.
3. The basin-fill sediment unit was eliminated from further consideration for a new groundwater source because of low well yields.
4. The younger alluvium unit consists of sediments deposited within the floodplain of the Willamette River. The coarser section of the unit comprises the alluvial aquifer, the most productive aquifer in the Newberg area, and is the source of supply for the City's well field. The highest-potential alternative for developing a new, high-capacity groundwater source is to target the coarse material found in the younger alluvium near the Willamette River.

Water Rights

Four different alternatives for obtaining authorization to appropriate water from a new source were evaluated:

1. Obtain a new surface water right, should the City desire to develop a new surface source
2. Acquire an existing surface water right
3. Obtain a new groundwater right
4. Utilize (transfer) the City's existing groundwater rights

All four of the alternatives were found to be feasible, with availability of groundwater rights (new or transferred) limited to the alluvial aquifer present near the Willamette River.

Aquifer Storage and Recovery (ASR)

In addition to the considered alternatives for developing a new groundwater source, ASR also was considered as a strategy for enhancing supply capacity during periods of high demand. ASR is the underground storage of treated drinking water in a suitable aquifer and the subsequent recovery of the water from the same well or wells, generally requiring no re-treatment other than disinfection. The specific alternative evaluated was an ASR system using treated alluvial groundwater from the WTP as the injection source and using the CRBG as the storage aquifer. As discussed above, the presence, structure, and productivity of the CRBG in the Newberg area is highly uncertain. The ASR alternative was not considered further in this evaluation because of the high cost to develop and test an ASR site and the high uncertainty regarding the suitability of the CRBG aquifers in the area for ASR.

Source Expansion Alternatives

The preliminary expansion assessment indicated that the alluvial aquifer provides the best opportunity for developing additional groundwater source capacity. Two overall alternatives for developing additional source capacity in the alluvial aquifer are available to the City:

- **Alternative 1** – expand existing well field capacity
- **Alternative 2** – develop capacity on the north side of the Willamette River

Two targeted options (Option A and B) were identified and evaluated within each of these alternatives.

Alternative 1 - Well field Capacity Expansion

The City has completed several studies since 1980 to evaluate the potential to develop groundwater supplies from the alluvial aquifer within the floodplain on the south side of the Willamette River. The outcome of these studies was continued expansion of the City's Marion County well field, centered on the thickest known section of saturated aquifer. The City has fully developed the pumping capacity of the majority of this channel feature, although the capacities of two wells (4 and 5) have diminished over time. While the aquifer becomes appreciably thinner northwest and south of the existing well field (**Appendix C, Figure 2**), the thickness and nature of the aquifer and potential presence of additional channel features have not been fully explored on the south end of the City's parcel, nor in the northerly portions of the adjacent parcel. The presence of undeveloped alluvial aquifer on the City's parcel and adjacent areas, and the diminished capacity of the City's older wells present a couple of options for developing additional capacity on the south side of the river. These options could be implemented independently or collectively:

- **Option 1A** - Evaluate whether the capacities of Well 4 and Well 5 can be restored and/or whether replacing Well 4 would be beneficial
- **Option 1B** - Fully explore the City's parcel and nearby areas, and drill a new well(s) based on the results of this exploration

Option 1A Improve or Replace Existing Wells in the Well field

This option would involve evaluating whether the performance of older existing Wells 4 and 5 could be restored to improve overall source capacity, and if not, whether the City should consider replacing Well 4. The performance and capacities of Wells 4 and 5 have been significantly diminished since originally installed. Recent advances in well assessment and rehabilitation methods may better inform the City whether to continue to operate these assets as-is or consider implementing a thorough and structured rehabilitation program to restore their capacity. One possible conclusion of the assessment would be that completing a comprehensive rehabilitation program would not be worthwhile. The assessment could also include an evaluation of whether replacing Well 4 would significantly improve overall source capacity given that Well 4 is located at a sufficient distance from the remainder of the wells to be less affected by interference.

Advantages:

- The existing well locations have been well-characterized.
- The City owns the property occupied by the existing wells and has land use approvals to use the parcel for municipal drinking water.
- The City holds undeveloped water right capacity for this aquifer. Changes to the City's water rights to add or move well locations should be relatively simple.
- Much of the access, power and conveyance infrastructure necessary to add capacity is already in place.

Disadvantages:

- Option 1A does not address the objective of developing supply redundancy on the north side of the river.

Option 1B Develop New Wells in the Well field or on Adjacent Parcel

A 1992 study for the City of Newberg by CH2M Hill estimated the capacity of a new well drilled within the thinner (~20 feet) section of the alluvial aquifer to be between 450 and 700 gpm. However, the well capacity potential for certain portions of the City's parcel and the adjacent western parcel is not fully understood because the depth, thickness and nature of the alluvial aquifer has not been fully explored. Option 1B would involve exploration to fill-in information gaps about the thickness of the alluvial aquifer on the City's parcel. The desired capacity increment would then be developed by installing wells in the most advantageous locations. Locations would be identified based on capacity, property, permitting, and infrastructure (power and conveyance) costs.

Advantages:

- The City owns the property occupied by the existing wells and has land use approvals to use the parcel for municipal drinking water.
- The City holds undeveloped water right capacity for this aquifer. Changes to the City's water rights to add or move well locations should be relatively simple.
- Much of the access, power and conveyance infrastructure necessary to add capacity is nearby.

Disadvantages:

- Option 1B does not address the objective of developing supply redundancy on the north side of the river.
- The yield of individual wells may be significantly lower than the City's existing wells, resulting in a higher cost per unit capacity.
- The City does not own the adjacent parcel.

Alternative 2 - North Side Capacity Development

This alternative involves developing source capacity through new wells in the alluvial aquifer on the north side of the Willamette River. Target areas (options) for exploring the presence and nature of the alluvial aquifer include: They are illustrated in **Appendix C, Figures 1 and 3.**

- **Option 2A Gearns Ferry Area** - floodplain in the vicinity adjacent to Highway 219
- **Option 2B Southwest Area** - floodplain between Rogers Landing County Park (County Park) and the City of Dundee

Option 2A Develop New Wells in the Gearn's Ferry Area

The Gearn's Ferry Area was identified during previous groundwater supply studies as having potentially favorable conditions for developing a groundwater supply source from the alluvial aquifer (CH2M Hill, 1997). The Gearn's Ferry Area includes two parcels owned by Chehalem Parks and Recreation District (CPRD) adjacent to the east and west sides of Highway 219. The remainder of the Gearn's Ferry Area is privately-owned. Nearly all of the floodplain is in cultivation and the land is designated exclusive farm use (EFU).

The City completed a limited evaluation of the groundwater supply potential of the eastern portion of the CPRD property in 2006 (GSI, 2006). The evaluation was based on the identification of productive aquifer conditions in two irrigation wells located on the Willamette Farms property to the east of the CPRD parcel and an irrigation/domestic well located to the west (**Appendix C, Figure 4**). The investigation included drilling an exploratory borehole on the east edge of the CPRD property and water quality testing of the Willamette Farms wells. Although the test borehole did not intercept a thick sequence of productive material, the majority of the CPRD property remains unexplored and appears to have potential to host a thicker sequence of productive alluvial aquifer materials. The 2006 investigation did identify the presence of cyanide in a sample from one of the Willamette Farms wells, likely a residue from agricultural chemical use. Consequently, additional investigation of groundwater quality and current agricultural practices at the Willamette Farms and CPRD parcels, as well as water quality testing on the CPRD site, would be necessary to assess the risks to source water quality prior to investing in a supply source at this location.

Advantages:

- Option 2A addresses the City's objective of developing redundant capacity on the north side of the river to improve system resiliency.
- Some property is publicly owned.
- Water rights currently held by the City could be used for wells completed in the alluvial aquifer.
- Wells in the vicinity indicate productive aquifer materials are present nearby.

Disadvantages:

- Potential well yields and water quality are uncertain because the area has not been adequately explored.
- Land use related risks to water quality must be evaluated.
- The area is distant from existing conveyance infrastructure.

Option 2B Develop New Wells in the Southwest Area

The Southwest Area, encompassing the floodplain between County Park and the City of Dundee, is the other proximal area with potentially-favorable hydrogeologic conditions for development of a groundwater source in the alluvial aquifer on the north side of the river

(Appendix C, Figure 5). However, this particular area has several challenges, and thus is less favorable than the Gearns Ferry Area in Option 2A.

Similar to the CPRD property, further investigation is necessary to evaluate the feasibility of developing a groundwater source in the Southwest Area. Two primary data gaps must be addressed: (1) verify the presence and pumping capacity of the aquifer, and estimate well yields; and (2) evaluate groundwater quality, potential landfill impacts, and current and potential future agricultural practices to assess risks to source water quality.

Advantages:

- Option 2B addresses the City’s objective of developing redundant capacity on the north side of the river to improve system resiliency.
- Water rights currently held by the City could be used for wells completed in the alluvial aquifer.

Disadvantages:

- Very little information is available to assess the yield potential in the area.
- The proximity of the closed landfill may have negative implications for water quality, and the risk of contamination must be evaluated thoroughly.
- Privately held agricultural land designated EFU may present access and land use challenges.
- The area is distant from existing conveyance infrastructure.

Source Conclusion

The groundwater source expansion assessment identified two overall alternatives for developing additional source capacity in the alluvial aquifer, and for each of the two alternatives, the two best options were evaluated:

- Alternative 1 – expand existing well field capacity
 - Option 1A – improve or replace existing wells in the well field
 - Option 1B – develop new wells in the well field or on adjacent parcel
- Alternative 2 - develop capacity on the north side of the Willamette River
 - Option 2A – develop new wells in the Gearns Ferry Area
 - Option 2B – develop new wells in the Southwest Area

While Options 1A and 1B hold significant advantages, such as, a well-characterized aquifer, existing land use approvals, simple water right transactions, and proximity to infrastructure, they do not address the City’s high-priority objective of developing supply redundancy on the north side of the Willamette River.

Options 2A and 2B address this important objective, and they share several advantages and disadvantages, such as, similar water rights framework, little information to predict well

yields, and distance to existing infrastructure. Option 2B is considered less favorable than Option 2A because there is less available information to assess potential yield, there is greater uncertainty about water quality, and there is no publicly-owned land in the vicinity.

Based on this analysis, the best source expansion option is Option 2A. This option meets the objective of developing redundant supply on the north side of the Willamette River. The information related to existing wells in this area indicates the alluvial aquifer has productive material here. The City's existing water rights could be used for wells in the alluvial aquifer in the Earns Ferry Area, and some property is publicly owned by the CPRD.

In addition to further exploration to identify alluvial aquifer characteristics in the area, impacts to water quality from surface activities such as agriculture must also be evaluated.

Although this appears to be the most feasible option for redundant supply currently, it is anticipated that the City will evaluate other source water options as opportunities arise.

Transmission and Treatment for Redundant Supply

It is anticipated that new wells developed in the alluvial aquifer would require treatment for high levels of iron and manganese consistent with the City's existing wells. Based on a proposed north side well location in the Earns Ferry Area (Option 2A), approximately 2 miles of transmission mains would be needed to carry raw water from a proposed well to the existing WTP. Alternatively, water could be treated at the well site using oxidation and a pressure filter system for iron and manganese followed by on-site disinfection. Approximately 1.3 miles of finished water transmission mains along Highway 219 would then carry the treated water to existing distribution at NE Wynooski Road. Treatment at the proposed well site is the recommended option for planning purposes because less transmission piping is required and a separate treatment system makes the proposed well a truly independent redundant supply. Much of the recommended exploration area is within the 100-year flood plain. Depending on the final well site selected, siting treatment facilities on nearby parcels of higher ground out of the flood plain may be an important consideration in developing this redundant supply.

Redundant Supply Estimated Cost

The City should pursue a redundant supply in the Earns Ferry area on the north side of the Willamette River near the current Highway 219 bridge. The redundant supply, with an approximate capacity of 2 mgd, would consist of a new groundwater well, on-site treatment for iron and manganese, on-site disinfection and approximately 1.3 miles of 12-inch diameter transmission mains from the new well to existing distribution at Highway 219 and NE Wynooski Road. **Table 4-4** summarizes planning level costs for each of these supply components. As described under *Source Expansion Alternatives* earlier in this section, additional exploration is needed in the Earns Ferry area to confirm hydrogeology and water quality prior to selecting a final well site. Costs for this additional exploration are also included in **Table 4-4**.

**Table 4-4
Redundant Supply Cost Estimate Summary**

Supply Component	Development Phase or Facility	Item Description	Assumptions	Total Cost
Source	Feasibility and Exploration	Water Rights Evaluation	Review water rights and permitting alternatives, meet with OWRD to determine next steps for permitting	\$ 2,500
		Geophysical Explorations	Two field days, consultant provides field support for contractor	\$ 27,500
		Subsurface Investigation and Testing	Sonic borings, 6-inch test well with two 2-inch monitoring wells	\$ 128,000
		Water Quality Assessment	Three water quality samples submitted for metals, pesticides and cyanide	\$ 5,000
	Well Development	2 mgd Production Well	One well only	\$ 360,000
		Water Rights Preparation		\$ 5,000
	Well house and well head Improvements			\$ 500,000
Treatment	Iron and Manganese	On-site oxidation and filtration	Sodium hypochlorite injection for oxidation, manganese dioxide media pressure filter for filtration	\$ 450,000
	Disinfection	On-site injection of sodium hypochlorite	Bulk sodium hypochlorite delivered to site, no on-site generation	\$ 150,000
Transmission	Finished Water Transmission Main	12-inch diameter ductile iron		\$ 1,991,000
TOTAL Redundant Supply Development Cost				\$ 3,619,000

SECTION 5

WATER DISTRIBUTION SYSTEM ANALYSIS

This section presents an analysis of the City of Newberg's (City's) water distribution system based on criteria outlined in **Section 3**. The water demand forecasts summarized in **Section 2** are used in conjunction with analysis criteria to assess water system characteristics including service pressures, storage and pumping capacity and emergency fire flow availability. This section provides the basis for the recommended Capital Improvement Program (CIP) presented in **Section 7**.

Pressure Zone Analysis

Pressure zones are defined by ground topography. Their hydraulic grade lines (HGLs) are determined by overflow elevations of water storage reservoirs, discharge pressures of pump stations or outlet settings of pressure reducing facilities serving the zone. The City's two existing pressure zones provide adequate service pressure to all customers. A third pressure zone is recommended within the 20-year planning horizon to supply potential new development at higher elevations northeast of the existing service area. Beyond 20 years it is anticipated that a fourth pressure zone will be needed to serve customers at the highest elevations in the City's North Hills Urban Reserve Area (URA). Proposed Zone 4 is not explicitly addressed in the distribution system analysis as it is outside of the 20-year service area for this Master Plan. Existing and proposed future pressure zones are illustrated on the water system maps in **Appendix A**.

Existing Pressure Zones

The City's existing distribution system is almost entirely served from Zone 1 which is supplied by the Water Treatment Plant (WTP) and the North Valley and Corral Creek Reservoirs at approximate HGL of 403 feet. Zone 1 provides adequate service pressure to customers below approximately 310 feet elevation. Zone 2, serving the Oak Knoll neighborhood at the northern edge of Newberg, is supplied by constant pressure pumping from the Oak Knoll Pump Station. Zone 2, with an approximate HGL of 470 feet, currently provides adequate service pressure to customers between approximately 310 and 350 feet elevation.

Zone 2 North Expansion to Veritas School Site

The City has entered an agreement to expand Zone 2 water service from the Oak Knoll Pump Station north on N College Street to the proposed Veritas School property at the intersection of N College Street and NE Bell Road. An 8-inch diameter main was recently completed from Oak Knoll Pump Station along N College Street to the school property. In addition to the school, other properties north of the Zone 2 boundary including the North Valley Friends Church and a proposed 11-unit residential development at 4016 N College (Rourke Property) are expected to connect to City water service from this 8-inch main. For the purposes of this

analysis, completion of these additional Zone 2 customer connections is assumed to occur within the next 5 years as reflected in the future water demand by pressure zone summarized in **Table 2-4** in **Section 2**.

Required fire flow has yet to be determined by the Newberg Fire Marshal for these proposed Zone 2 future customers as they are currently outside of the city limits. For this analysis it is assumed that the maximum fire flow required in Zone 2 will continue to be 1,000 gpm. However, to be consistent with the City's 2015 *Public Works Design and Construction Standards*, when the properties are annexed into the City of Newberg, it is likely the required fire flow without automatic fire sprinklers for the church and school will be at least 3,000 gpm and up to 4,500 gpm. The existing Oak Knoll Pump Station does not have adequate capacity under any conditions to supply a fire flow requirement larger than 1,260 gpm, which is the current nominal capacity of the station with all pumps operating.

Proposed Future Pressure Zones

As development continues in the Urban Growth Boundary (UGB) and the City's water service area expands to the northeast, a new Zone 3 is proposed to serve new development at higher elevations. The proposed Zone 3 would supply customers between approximately 310 and 440 feet elevation around NE Zimri Drive north of the Allison Inn.

Although initial development in Zone 3 could be independently served by a constant pressure pump station, it is recommended that the City pursue long-term development of a storage reservoir to supply Zone 3 customers by gravity. The proposed reservoir would ultimately serve future customers in the City's largest URA, the North Hills URA, which is anticipated to develop beyond the 20-year planning horizon of this Master Plan.

Customers in the North Hills URA below approximately 440 feet elevation will be served from proposed Zone 3. Customers between approximately 440 and 560 feet are assumed to be served by a future Zone 4. It is assumed that the proposed reservoir will be designed to operate at an HGL to serve future Zone 3 customers by gravity. Future Zone 4 customers would then be served by constant pressure pumping from Zone 3. Zone 4 is anticipated to develop beyond the 20-year planning horizon, thus no further analysis of Zone 4 water service is included in this Plan.

For this analysis, it is assumed that Zone 2 customers will ultimately be served from Zone 3 following construction of the proposed reservoir and necessary transmission piping beyond the 20-year planning horizon.

Storage Capacity Analysis

Storage facilities are provided for three purposes: operational storage, fire storage and emergency storage. As presented in **Section 3**, the total storage required in each pressure zone is the sum of these three elements.

- **Operational Storage** – volume needed to meet peak hour demand (PHD) for 2.5 hours with all non-emergency pumps supplying the zone
- **Fire Storage** – the most severe fire flow requirement in the zone multiplied by the duration of that flow specified in the 2014 *Oregon Fire Code*
- **Emergency Storage** – 100 percent of maximum daily demand (MDD) in the zone

Storage reservoirs must have adequate capacity to meet demands within the pressure zone being supplied by gravity as well as demands in any constant pressure zones pumping out of the gravity zone. In the existing Newberg water system, this means adequate storage must be available in Zone 1 reservoirs to meet storage requirements for Zone 1 customers who are served by gravity and Zone 2 customers who are supplied constant pressure from the Oak Knoll Pump Station. Constant pressure zones, like Zone 2, cannot be adequately supplied fire flow from a lower-elevation reservoir and must have adequate pumping capacity to meet fire flow requirements as presented later in this section. Existing and projected future storage capacity requirements are summarized in **Table 5-1**.

Existing Storage Capacity Findings

Existing Zone 1 storage reservoirs have adequate capacity to meet storage requirements under existing and projected future demand conditions through the 20-year planning horizon.

Proposed Bell Road Reservoir

As discussed earlier in this section, continued development northeast of the City's existing service area will require a new Pressure Zone 3 to serve customers above approximately 310 feet elevation within the UGB and the North Hills URA. The proposed Zone 3 within the UGB would initially be served by constant pressure pumping.

As development warrants beyond the 20-year planning horizon, it is recommended the City construct a new storage reservoir on City-owned property north of Bell Road near the intersection with Zimri Drive. The proposed Bell Road Reservoir will ultimately serve Zone 3 customers within the current UGB, future Zone 3 and 4 customers within the North Hills URA and Zone 2 customers following construction of the proposed reservoir and necessary distribution piping. It is assumed that the proposed Bell Road Reservoir will be designed to operate at an HGL to serve future Zone 3 customers by gravity.

Bell Road Reservoir Capacity

The proposed Bell Road reservoir has an estimated 20-year storage need of approximately 0.24 MG to serve future Zone 3 customers within the UGB. A total storage capacity of 1.69 MG is needed to serve Zone 2 and proposed Zones 3 and 4 beyond the 20-year planning horizon when and if development occurs in the North Hills URA. The total recommended storage capacity for the Bell Road Reservoir is 1.7 MG.

Estimates of proposed Bell Road storage capacity assume a maximum residential fire flow requirement of 1,500 gpm based on potential medium density residential development in future Zones 3 and 4. If the fire flow requirement for the Veritas School in Zone 2 is higher than 1,500 gpm it will impact required storage capacity, adding up to an additional 0.9 MG at a required fire flow of 4,500 gpm which is the maximum requirement from the City's 2015 *Public Works Design and Construction Standards*.

Estimates of proposed Bell Road storage capacity also assume the reservoir will ultimately be supplied by two pump stations, a proposed Bell East Pump Station on Zimri Drive just north of the Allison Inn and a proposed Bell West Pump Station on N College Street near the existing Oak Knoll Pump Station. These proposed pump stations are discussed in more detail in the following paragraphs. It is assumed that the City will re-evaluate the proposed Bell Road Reservoir capacity during reservoir pre-design based on the actual timing and character of development in the UGB and URA.

**Table 5-1
Storage Capacity Analysis**

See Note 1

Pressure Zone	Timeframe	Other Zones Served ¹	Required Storage (MG)				Existing Reservoirs	Existing Storage (MG)	Additional Storage Need (MG)
			Operational	Fire ²	Emergency	Total			
Zone 1	Current	Zone 2	-	1.08	4.79	5.87	North Valley 1 & 2 and Corral Creek	12.00	-
	5-year (2020)		-	1.08	5.70	6.78		12.00	-
	10-year (2025)		-	1.08	6.47	7.55		12.00	-
	20-Year (2035)		-	1.08	7.72	8.80		12.00	-
Zone 3	5-year (2020)	None	-	0.18	0.02	0.20	None	-	0.20
	10-year (2025)		-	0.18	0.05	0.23		-	0.23
	20-Year (2035)		-	0.18	0.06	0.24		-	0.24
	Beyond 20 years	Zone 2 and Zone 4	0.09	0.18	1.42	1.69		-	1.69

Notes:

1. Zone 2 is currently supplied by constant pressure pumping from Zone 1, thus Zone 1 storage must have adequate capacity to serve Zone 2. After construction of the proposed Zone 3 reservoir, assumed to occur beyond the 20-year planning horizon, Zone 2 customers would be served by gravity from the new Zone 3 storage reservoir.
2. Required maximum fire flow for Zone 2 is assumed to be the current 1,000 gpm and proposed Zones 3 and 4 is assumed to be 1,500 gpm. If the fire flow requirement for the Veritas School or other structures in these future zones is determined to be larger than 1,500 gpm it will impact the storage needed up to an additional 0.9 MG with a required flow of 4,500 gpm. This is the maximum requirement from the City's 2015 *Public Works Design and Construction Standards*.

Table 5-2
Pumping Capacity Analysis
See Note 1

Pressure Zone	Timeframe	Other Zones Served	Criteria	Req'd Firm Capacity (gpm)	Existing Pumps	Firm Capacity (gpm)	
						Existing	Additional Need
Zone 1	Current	Zone 2	MDD	3,327	WTP High Service	6,900	-
	5-year (2020)	Zone 2 & Zone 3		3,972			-
	10-year (2025)			4,528			-
	20-Year (2035)			5,403			-
Zone 2	Current	-	PHD + Fire Flow ²	1,049	Oak Knoll	260	789
	5-year (2020)			1,639			1,379
	10-year (2025)			1,639			1,379
	20-Year (2035)			1,639			1,379
	Beyond 20 years	MDD	375	None ¹	-	375	
Zone 3	5-year (2020)	-	PHD + Fire Flow	1,521	None	-	1,521
	10-year (2025)			1,562			1,562
	20-Year (2035)			1,569			1,569
	Beyond 20 years	Zone 4	MDD	612			612

Notes:

- Existing Oak Knoll Pump Station is assumed to be abandoned following construction of proposed Bell West Pump Station to serve Zone 2 and ultimately proposed Bell Road Reservoir.
- Required maximum fire flow for Zone 2 is assumed to be the current 1,000 gpm requirement. If the fire flow requirement for the Veritas School or other structures included in the Zone 2 north expansion is determined to be larger than the current 1,000 gpm requirement, it will impact the firm pumping capacity needed within the 20-year timeframe up to an additional 3,500 gpm with a total required flow of 4,500 gpm. This is the maximum requirement from the City's 2015 *Public Works Design and Construction Standards*.

Note 1: See Appendix E, Addendum Riverfront Master Plan (Adopted 5/3/21)

Pumping Capacity Analysis

Pumping capacity requirements are estimated based on available storage, the number and size of pumps serving each pressure zone and the zone's maximum fire flow requirement. Recommendations are based on firm capacity which is defined as a pump station's capacity with the largest pump out of service, measured in gallons per minute (gpm).

In pressure zones supplied by gravity, like Zone 1, operational and fire storage provided by reservoirs make it unnecessary to plan for fire flow or peak hour capacity from pump stations, assuming adequate storage is available. Pump stations supplying gravity zones must have sufficient firm capacity to meet the maximum day demand for all customers in the zone and any higher zones supplied from the primary zone.

Constant pressure pump stations supply a pressure zone without the benefit of storage, like Zone 2. Zones served by constant pressure pumping present a higher level of risk for water providers as a total loss of service pressure could occur with a power outage or main break in the zone. This loss of pressure temporarily leaves customers without water in their homes or for fire suppression and may result in a boil water advisory. However, constant pressure stations may be the only cost-effective way to serve some areas in the distribution system which would otherwise require an elevated reservoir to provide pressure by gravity. Due to these potential risks, these stations are only recommended for areas with few services and low water demand. Pump stations supplying constant pressure service must have firm pumping capacity to meet peak hour demands while simultaneously supplying the largest fire flow demand in the zone. The pumping capacity analysis is summarized in **Table 5-2**.

**Table 5-2
Pumping Capacity Analysis**

Pressure Zone	Timeframe	Other Zones Served	Criteria	Req'd Firm Capacity (gpm)	Existing Pumps	Firm Capacity (gpm)	
						Existing	Additional Need
Zone 1	Current	Zone 2	MDD	3,327	WTP High Service	6,900	-
	5-year (2020)	Zone 2 & Zone 3		3,972			-
	10-year (2025)			4,528			-
	20-Year (2035)			5,403			-
Zone 2	Current	-	PHD + Fire Flow ²	1,049	Oak Knoll	260	789
	5-year (2020)			1,639			1,379
	10-year (2025)			1,639			1,379
	20-Year (2035)			1,639			1,379
	Beyond 20 years	MDD	375	None ¹	-	375	
Zone 3	5-year (2020)	-	PHD + Fire Flow	1,521	None	-	1,521
	10-year (2025)			1,562			1,562
	20-Year (2035)			1,569			1,569
	Beyond 20 years	Zone 4	MDD	612			612

Notes:

- Existing Oak Knoll Pump Station is assumed to be abandoned following construction of proposed Bell West Pump Station to serve Zone 2 and ultimately proposed Bell Road Reservoir.
- Required maximum fire flow for Zone 2 is assumed to be the current 1,000 gpm requirement. If the fire flow requirement for the Veritas School or other structures included in the Zone 2 north expansion is determined to be larger than the current 1,000 gpm requirement, it will impact the firm pumping capacity needed within the 20-year timeframe up to an additional 3,500 gpm with a total required flow of 4,500 gpm. This is the maximum requirement from the City's 2015 *Public Works Design and Construction Standards*.

Existing Pumping Capacity Findings

The existing Water Treatment Plant (WTP) High Service Pumps have adequate capacity to supply projected system-wide demands through the 20-year planning horizon. The Oak Knoll Pump Station, serving Zone 2, is not currently equipped with a redundant high capacity pump to meet fire flow demands. The station's existing high capacity pump is sized for a flow of 1,000 gpm.

Proposed Pump Stations

To supply future customers at higher elevations north of the City's existing service area additional high elevation pressure zones are needed. Development in these areas is anticipated to be incremental with many new customers connecting to the City water system beyond the 20-year planning horizon from new development in the North Hills URA. Thus, a phased approach to pumping and storage facilities is needed to provide water service while distributing capital improvement costs and maintaining adequate water circulation for water quality throughout the system. It is recommended that high elevation service areas initially be served by constant pressure pump stations, transitioning to gravity service following construction of the proposed Bell Road Reservoir beyond the 20-year planning horizon.

Bell East Pump Station

For the purposes of this Master Plan it is assumed that Zone 3 development within the UGB will be served by constant pressure pumping from the proposed Bell East Pump Station through the 20-year planning horizon.

Concurrent with construction of the Bell Road Reservoir, Bell East Pump Station will be modified to supply the reservoir which will then serve customers by gravity. The proposed pump station, located on Zimri Drive just north of the Allison Inn will draw suction supply from existing 24-inch diameter Zone 1 distribution mains on Zimri Drive.

Bell East Capacity

As shown in **Table 5-2**, Bell East has a proposed firm capacity of approximately 1,600 gpm through the 20-year planning horizon to provide PHD and residential fire flow to future Zone 3 customers within the UGB.

Following construction of the Bell Road Reservoir beyond 20 years, Bell East Pump Station would need a firm capacity of approximately 700 gpm to fill the reservoir at a rate approximately equal to the MDD for future Zone 3 and 4 customers within the UGB and North Hills URA.

Bell West Pump Station

The proposed Bell West Pump Station will serve existing Zone 2 customers and the Zone 2 expansion to the Veritas School by constant pressure pumping through the 20-year planning horizon. It is anticipated the existing Oak Knoll Pump Station will be abandoned following construction of Bell West.

Following construction of the Bell Road Reservoir and approximately 6,000 linear feet (1.1 miles) of transmission main along Bell Road between Zimri Drive and N College Street, Bell West Pump Station will be modified to supply the reservoir which will then serve former Zone 2 customers by gravity. The proposed pump station, located on N College Street near the Madison Drive alignment will draw suction supply from 18-inch diameter Zone 1 mains supplying the North Valley Reservoirs at N College Street and N Terrace Drive.

Bell West Capacity

As shown in **Table 5-2**, Bell West has a proposed firm capacity of approximately 1,400 gpm through the 20-year planning horizon to provide PHD and a residential 1,000 gpm fire flow to Zone 2 including expansion to the Veritas School. If the fire flow requirement for the Veritas School in Zone 2 is higher than 1,000 gpm it will impact required pumping capacity, adding up to an additional 3,500 gpm.

Following construction of the Bell Road Reservoir beyond 20 years, Bell West Pump Station will need a firm capacity of approximately 400 gpm to fill the reservoir at a rate approximately equal to the projected MDD for Zone 2.

Back-Up Power

At least two independent power sources are recommended for the City's pump stations. It is recommended that pump stations supplying gravity storage reservoirs include, at a minimum, manual transfer switches and connections for a portable back-up generator. The emergency storage volume in each reservoir will provide short term water service reliability in case of a power outage at the pump station. Back-up power is particularly critical for stations which provide constant pressure service. On-site standby power generators with automatic transfer switches are recommended for constant pressure pump stations serving zones without the benefit of gravity storage.

An on-site back-up power generator is installed at the existing WTP which is capable of operating the high level pumps to fill Zone 1 reservoirs. The existing Oak Knoll Pump Station also has a back-up power generator.

It is recommended that proposed Bell East and Bell West Pump Stations have back-up power generators incorporated into their design.

Distribution Capacity and Hydraulic Performance

Hydraulic Model

A steady-state hydraulic network analysis model was used to evaluate the performance of the City's existing distribution system and identify proposed piping improvements based on hydraulic performance criteria, such as system pressure and flow velocity, described in **Section 3**. The purpose of the model is to determine pressure and flow relationships throughout the distribution system for average and peak water demands under existing and projected future conditions. Modeled pipes are shown as "links" between "nodes" which represent pipeline junctions or pipe size changes. Diameter, length and head loss coefficients are specified for each pipe and an approximate ground elevation is specified for each node.

The hydraulic model was developed for this Master Plan using the InfoWater modeling software platform with geographic information system (GIS) base mapping and operations data provided by the City. The model was calibrated using fire hydrant flow test data and analysis scenarios were created to evaluate existing and projected 20-year demands.

For distribution system modeling, the City's WTP High Service Pumps are assumed to be off. Zone 1 storage reservoirs are modeled approximately two-thirds full under peak demand conditions based on input from City staff regarding summertime operating levels.

Modeled Water Demands

Existing and projected future demands are summarized in **Section 2, Tables 2-2 and 2-4**. Within the existing water service area, demands are assigned to the model based on current customer billing address and billed water consumption. Future demands in water service expansion areas are assigned uniformly over each proposed pressure zone area illustrated on the water system maps in **Appendix A**.

Model Calibration

Model calibration typically involves adjusting the model parameters such that pressure and flow results from the model more closely reflect those measured at the City's fire hydrants. This calibration process tests the accuracy of model pipeline friction factors, demand distribution, valve status, network configuration, and facility parameters such as tank elevations and pump curves. The required level of model accuracy can vary according to the intended use of the model, the type and size of water system, the available data, and the way the system is controlled and operated. Pressure and flow measurements are recorded for the City's fire hydrants through a process called fire flow testing.

Fire Flow Testing

Fire flow testing consists of recording static pressure at a fire hydrant and then "stressing" the system by flowing an adjacent hydrant. While the adjacent hydrant is flowing, residual

pressure is measured at the first hydrant to determine the pressure drop that occurs when the system is “stressed”. Boundary condition data, such as reservoir levels and pump on/off status, must also be known to accurately model the system conditions during the time of the flow test. For this Master Plan, hydrant flow tests were conducted on April 6, 2016. The recorded time of each fire hydrant flow test was used to collect boundary condition information from the City’s supervisory control and data acquisition (SCADA) system.

Steady-State Calibration Results

For any water system, a portion of the data describing the distribution system will be missing or inaccurate and assumptions will be required. This does not necessarily mean the accuracy of the hydraulic model will be compromised. Depending on the accuracy and completeness of the available information, some pressure zones may achieve a higher degree of calibration than others. Models that do not meet the highest degree of calibration can still be useful for planning purposes.

Pump discharge flow and pump curves were not available for the Oak Knoll Pump Station, serving the City’s Pressure Zone 2 through constant pressure pumping. The absence of accurate flow data for constant pressure zones makes it difficult to accurately model the Oak Knoll Pump Station. Flows were approximated based on the assigned demands in the model, City-provided pump nominal capacities and discharge pressure measured at the station.

The model calibration’s confidence level was evaluated based on the difference between modeled and field-measured pressure drops during fire hydrant flow testing, in pounds per square inch (psi), as summarized in **Table 5-3**. Overall system calibration confidence is considered high.

**Table 5-3
Calibration Confidence**

Confidence Level	Field-Measured vs. Modeled Pressure Drop Difference
High	+5 psi
Medium	+5-10 psi
Low	>10 psi

Fire Flow Analysis

Fire flow scenarios test the distribution system’s ability to provide required fire flows at a given location while simultaneously supplying MDD and maintaining a minimum residual service pressure of 20 psi at all services. Required fire flows are assigned based on the zoning surrounding each hydrant as summarized in **Section 3, Table 3-1**.

The City's existing distribution mains are well looped with adequate fire flows available in most areas and relatively few piping improvements recommended for fire flow. Piping improvements are primarily needed in older parts of the water system including smaller diameter water mains adjacent to George Fox University and undersized 1- and 2-inch mains with few interconnections serving E Hancock Street (Highway 99W) between N Grant and N Edwards Streets downtown.

Peak Hour Demand Analysis

Distribution system pressures were evaluated under peak hour demand conditions to confirm identified piping improvements. Peak hour demands were estimated as 1.7 times the maximum day demand. No additional pressure deficiencies were identified under these conditions.

Distribution System Water Quality

The City of Newberg meets all current drinking water quality regulations. This analysis focuses on microbial contaminants (Total Coliform Rule), lead and copper (Lead and Copper Rule) and disinfection by-products (Stage 2 Disinfectants and Disinfection Byproducts Rule) which may be exacerbated or originate in the distribution system.

Total Coliform Rule Compliance

The City is currently meeting all applicable requirements for the Total Coliform Rule. It is important to maintain active circulation of water throughout the distribution system, in both pipes and reservoirs in order to retain a chlorine residual. The absence of chlorine residual and accumulation of sediments contribute to bacterial growth, which in turn can result in failure to comply with this rule.

Lead and Copper Rule Compliance

The City uses caustic soda to raise the pH of treated water leaving the WTP. Newberg has been in compliance with the Lead and Copper Rule since 1997 when this pH adjustment system was installed. There appear to be no concerns with future compliance with the Lead and Copper Rule.

Stage 2 Disinfectants and Disinfection Byproducts Rule (D/DBPR) Compliance

Currently, the City conducts quarterly sampling for DBP at the following four sample sites, all of which are currently in compliance:

- North Valley Reservoirs (25600 North Valley Road)
- Corral Creek Reservoir (31451 Corral Creek Road)
- 3743 Dahlia Street
- 210 The Greens

Summary

This section presented an analysis of the City of Newberg's water distribution system based on projected future water demands presented in **Section 2** and performance criteria outlined in **Section 3**. This water system assessment includes service pressures and zone boundaries, storage and pumping capacity and emergency fire flow availability. This section provides the basis for recommended distribution system improvements presented in **Section 7** Capital Improvement Program.



SECTION 6

OPERATIONS AND MAINTENANCE

This section assesses the City of Newberg’s (City’s) Operations and Maintenance (O&M) program for its water system. The assessment is based on information from City staff compared with American Water Works Association (AWWA) standards, the O&M practices of similarly sized utilities, and pertinent regulatory requirements. Recommendations for improvements to the City’s O&M program, described at the end of this section, are based on the results of this assessment.

Existing O&M Structure

The City’s Public Works Department staff are responsible for the maintenance and operation of the water distribution and treatment systems. Newberg Public Works is structured into three major divisions; Operations, Maintenance, and Engineering. This section focuses on the work of the Operations and Maintenance divisions. Within these divisions staff are charged with O&M for a variety of public facilities including both water and wastewater utilities, fleet maintenance, street repair and grounds maintenance. This generalized structure allows staff to support multiple facilities and for administrative functions to be shared across utilities. Water utility responsibilities for each division are as follows:

Operations Division

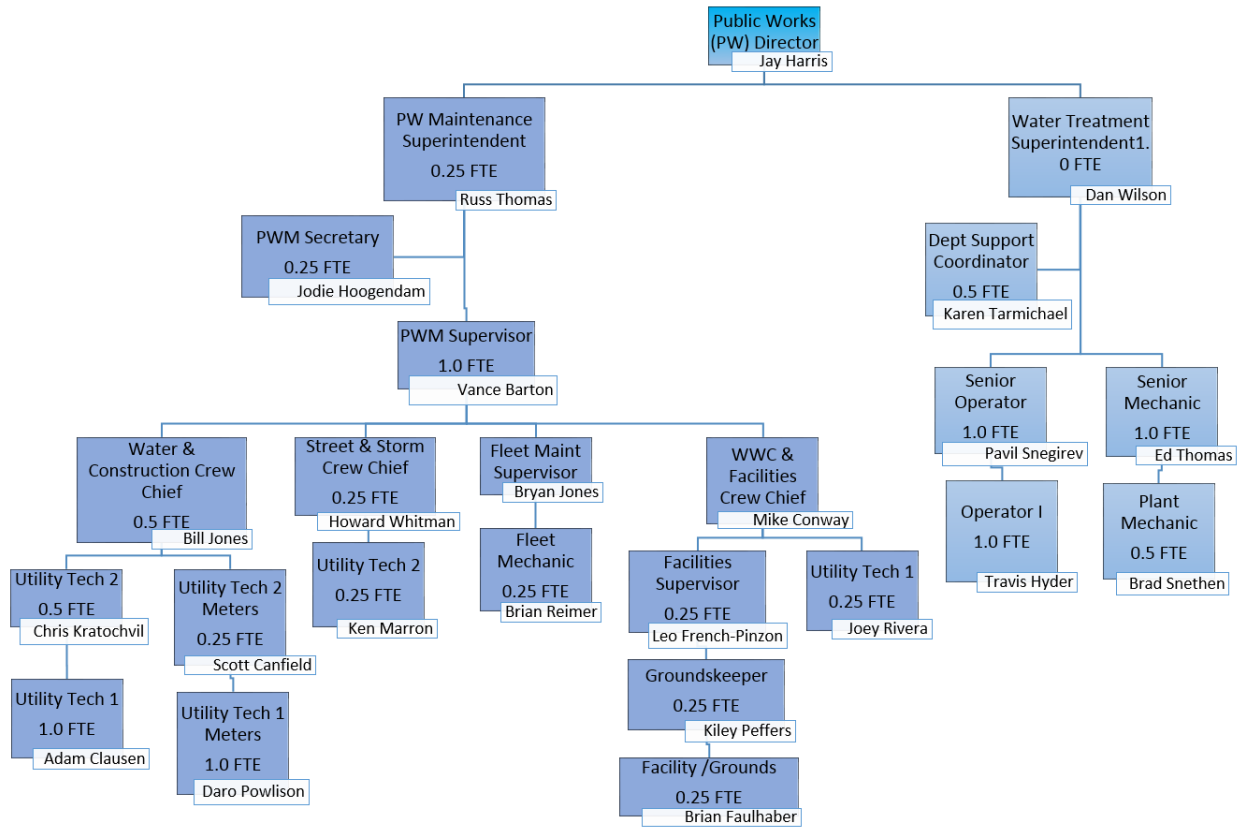
- Water Treatment Plant
- Well field
- Storage reservoirs
- Pump stations

Maintenance Division

- Distribution main flushing & repair
- Valves & hydrants
- Meter reading
- Investigate & address customer complaints

The water utility has budgeted staff time of 5 full-time equivalent employees (FTEs) from the Operations Division and 6.5 FTEs from the Maintenance Division. **Figure 6-1** shows the organizational structure for O&M staff whose time is allocated to the water system. The City is currently evaluating the Maintenance Division organizational structure. Anticipated changes include a move towards more defined crews for each utility rather than, for instance, a general public works construction crew.

Figure 6-1 Water Utility Public Works Staff FTE



O&M Regulations and Guidelines

Oregon Administrative Rules (OAR) 333-061-0065 govern O&M of public water systems with the primary directive that they be “operated and maintained in a manner that assures continuous production and distribution of potable water”. These rules establish general requirements for leak repair, proper and functioning equipment, emergency planning, and current documentation.

The AWWA G200 Distribution Systems Operation and Management standard provides recommendations for routine maintenance programs, handling customer complaints, and record keeping which address the O&M goals and requirements of the OAR.

The City has also established ordinances regarding connection to the water system, cross-connection, backflow prevention, and water conservation and curtailment as described in Newberg Municipal Code Chapter 13.15.

Operator Certification

OAR 333-061-0200 defines requirements for water system operator certification. Personnel in charge of operations for all community water systems, like Newberg’s water system, are required to be certified through the Oregon Water System Operator’s Certification Program. Water distribution and water treatment operators must receive certification in accordance with the classification of the system they operate. The City’s classifications are:

- **Water Treatment 2** – based on the complexity of water treatment required
- **Water Distribution 3** - based on a service area population between 15,000 and 50,000 people, Newberg’s service population is approximately 22,900

State guidelines also require water suppliers to identify an operator with these levels of certification as being in “direct responsible charge” (DRC) of the treatment and distribution systems. In Newberg, these roles are filled by the Water Treatment Superintendent and the Maintenance Superintendent respectively. **Table 6-1** summarizes current Oregon water operator certification levels held by Newberg public works staff.

**Table 6-1
Certification Status of Personnel**

Certification Number	Name	Job Title	Certification
D-5076, T-5076	Dan Wilson	Water Treatment Superintendent / Cross Connection Specialist – DRC treatment	WD-2, WT-3
D-08243, T-08150	Pavil Snegirev	Senior Water Treatment Operator	WD-3, WT-3
D-1533	Russ Thomas	Maintenance Superintendent – DRC distribution	WD-3
D-6191	Vance Barton	Maintenance Supervisor	WD-3
D-6283	Michael Conway	Facilities & Field Ops Lead/Crew Chief	WD-2
D-6021	Scott Canfield	Maint Tech 2 – Cartograph / Meter Service	WD-2
D-08442	Chris Kratochvil	Maint Tech 1	WD-2

Current O&M Practices and Procedures

Both the Operations and Maintenance divisions implement procedures to ensure that the water system facilities function efficiently and meet level-of-service requirements (e.g., water quality and adequate service pressure). Routine procedures include visual inspection of system facilities, monitoring flow- and reservoir-level recording, and responding to customer inquiries and complaints. City staff handle the majority of O&M duties; however, tasks such as major water main repairs, well rehabilitation and reservoir painting are sourced to outside contractors.

System Operation

The City maintains and operates all facilities and appurtenances within the system, including customer meters. The customer is responsible for maintaining the water service line beyond the meter, typically located at the curb or near the property line. Meter reading is performed using a mobile Automatic Meter Reading (AMR) system and requires approximately 16 staff hours monthly to complete.

Each facility is typically inspected one to two times weekly to ensure security, proper operation and site maintenance. Chlorine residual and water pH in each finished water storage reservoir are checked twice a week. Well water levels are hand measured bi-monthly to verify well level indicators are reading accurately.

Field personnel monitor the water system's performance every day. Supervisory Control and Data Acquisition (SCADA) equipment at the City's the Water Treatment Plant (WTP) records the water pressure and metered flow at all wells, pressure at the Oak Knoll booster pump station, and water levels in the City's finished water storage reservoirs and WTP clearwell. Flow out of the WTP to distribution mains and storage reservoirs is recorded at the High Service Pumps. The volume of water produced at the WTP is totalized and recorded. Water personnel can use this data to detect any major abnormalities in the water system.

Water quality monitoring, as described in **Section 5**, is also performed by operations staff.

System Preventive Maintenance

The City's current preventive maintenance program consists of regularly servicing pumps and flushing water mains.

The City's water system includes well pumps, finished-water High Service Pumps at the WTP, raw water pumps at Otis Springs and booster pumps at the Oak Knoll Pump Station. Annual pump maintenance activities at one or more pump stations include:

- Clean variable frequency drives (VFDs)
- Test well pump output

- Test flow meters
- Change pump motor oil
- Inspect and, if needed, replace impellers
- Clean pump screens
- Fire pump testing (monthly)

Flushing is currently performed annually during the low demand winter season for a portion of the distribution system. With this annual flushing, the entire system is flushed on an approximately 4- to 5-year rotation. Dead ends are flushed every one to two years. Local flushing is also performed, as needed, in response to customer complaints.

The City does not currently have a formal valve exercising or hydrant maintenance program. Valves and hydrants are checked during flushing. Hydrants are repainted every 5 to 8 years using seasonal labor.

Other maintenance activities regularly performed by City staff include:

- Maintain grounds around City facilities
- Address customer complaints
- Exercising valves at system reservoirs, wells and pump stations
- Sodium hypochlorite generation cell service at WTP (semi-annually)
- Polymer pump maintenance
- Checking for leaks in bridge-mounted raw water transmission main

Record Keeping

Current water system mapping is maintained by the Engineering Division using Geographic Information Systems (GIS). Public Works Maintenance staff have access to view current mapping electronically. All mapping changes are processed by the Engineering Division's GIS Analyst based on paper mark-ups or as-builts provided by Maintenance.

The City manages water system assets using Cartegraph software. Cartegraph is used to record customer complaints and generate work orders for repair and maintenance activities. The current software will no longer be updated in 2017, and support will end in 2018. City staff are investigating options to update or convert to another asset management system.

Customer Complaints

Customers may call or email to file a complaint with any member of City staff. The initial contact forwards the complaint to the correct department and, depending on the nature of the complaint, it is investigated immediately to several days later. Complaints are addressed in the order of their severity and major issues are recorded in the City's current asset management software.

Conclusions and Recommendations

An effective O&M program addresses issues with customer interaction, water quality and infrastructure operations and maintenance. The City's current O&M program does not include some common best management practices of water utilities in the region. The City is currently evaluating water maintenance programs and assessing the need for additional routine maintenance.

Distribution System

Water distribution system O&M programs typically include the following maintenance programs:

- Dead-end main and hydrant flushing.
- Valve exercising.
- Leak detection.

It is difficult for water providers to address each item listed above. Consequently, it is important to prioritize maintenance of the critical infrastructures necessary to maintain effective service during an emergency. To accomplish this, the City should ensure adequate resources. Currently the City is completing dead-end main and hydrant flushing on a routine basis, and based on the limited number of water quality complaints and observed performance of hydrants during flow testing for this Master Plan, changes to the City's hydrant flushing program are not recommended.

To maintain a high level of service, the City should assess and identify critical components of the distribution system. To improve water distribution system O&M, it is recommended that the City develop the following programs:

1. A pipe replacement program based on a 100-year cycle as presented in **Section 5**.
2. A valve exercising program that operates all distribution valves on a 5-year basis to maintain the reliability of their service. If properly operated, most valves require less maintenance and will last a long time. Focus should be on critical isolation valves within the distribution system.
3. A leak-detection program may provide value to the City. At this point, the City is unable to perform an accurate comparison of water production and consumption to quantify water losses, thus, the value of a leak detection program is unclear. The City should invest in resolving this data discrepancy to determine if investment in leak detection is warranted. Typically, a leak detection program will provide value for systems with water loss rates in excess of 10 percent of annual water production.

Water Storage Tanks

To ensure a long tank life and good water quality, water storage tanks must be periodically inspected and maintained at least every five years, depending on the structure. Routine inspections aid in assessing the coating system and potential required repairs.

The following recommendations will allow the City to expand its water system maintenance program and improve its water storage tank operations and maintenance program:

4. Implement a water storage tank inspection and cleaning program to assess every storage tank within the system every 5 years. The City could consider contracting with an independent certified inspection company.

Staffing

The implementation of any of the recommendations presented above will result in a need for evaluation of staffing levels within the Maintenance department. In particular, staff availability to increase time dedicated to the water utility relative to other utility requirements will need to be considered.



SECTION 7

RECOMMENDATIONS AND CAPITAL IMPROVEMENT PROGRAM (CIP)

This section presents recommended improvements and capital maintenance for the City of Newberg's (City's) water system based on the analysis and findings presented in **Sections 4 and 5**. These improvements include supply, storage reservoir, pump station and water main projects. The capital improvement program (CIP) presented in **Table 7-5** later in this section summarizes recommended improvements and provides an approximate timeframe for each project. Proposed supply and distribution system improvements are illustrated on **Plate 1** in **Appendix A**.

Cost Estimating Data

An estimated project cost has been developed for each improvement project recommended in this section. Cost estimates represent opinions of cost only, acknowledging that final costs of individual projects will vary depending on actual labor and material costs, market conditions for construction, regulatory factors, final project scope, project schedule and other factors. The Association for the Advancement of Cost Engineering International (AACE) classifies cost estimates depending on project definition, end usage and other factors. The cost estimates presented here are considered Class 4 with an end use being a study or feasibility evaluation and an expected accuracy range of -30 percent to +50 percent. As the project is better defined, the accuracy level of the estimates can be narrowed.

Estimated project costs are based upon recent experience with construction costs for similar work in Oregon and southwest Washington and assume improvements will be accomplished by private contractors. Estimated project costs include approximate construction costs and an aggregate 44 percent allowance for administrative, engineering and other project related costs. Estimates do not include the cost of property acquisition. Since construction costs change periodically, an indexing method to adjust present estimates in the future is useful. The Engineering News-Record (ENR) Construction Cost Index (CCI) is a commonly used index for this purpose. For purposes of future cost estimate updating; the current ENR CCI for Seattle, Washington is 10623 (October 2016).

Water System Capital Improvement Program

A summary of all recommended improvement projects and estimated project costs is presented in **Table 7-5**. This CIP table provides for project sequencing by showing prioritized projects for the 5-year, 10-year and 20-year timeframes defined as follows:

- 5-year timeframe - recommended completion before 2022
- 10-year timeframe - recommended completion between 2022 and 2027
- 20-year timeframe - recommended completion between 2027 and 2037.

CIP Cost Allocation to Growth

Water system improvement projects are recommended to mitigate existing system deficiencies and to provide capacity to accommodate growth and service area expansion. Projects that benefit future water system customers by providing capacity for growth may be funded through system development charges (SDCs). To facilitate this SDC evaluation a preliminary percentage of the cost of each project which benefits future water system growth is allocated in the CIP table. The basis for percentages allocated to growth are described later in this section for each recommended facility and summarized in the CIP **Table 7-5**.

Projects such as water supply improvements are considered water system performance improvements which benefit all existing and future customers. The estimated costs of these improvements are allocated 44 percent to future growth based on the ratio of current to projected future system-wide maximum day demands (MDD) beyond 20 years including the City's Urban Growth Boundary (UGB) and North Hills Urban Reserve Area (URA).

Supply

Redundant Supply

As presented in **Section 4**, it is recommended that the City pursue development of a redundant water supply to address existing supply vulnerability and for long-term water system resiliency. The proposed redundant source is a new alluvial-aquifer well in the Gearns Ferry area on the north side of the Willamette River near the current Highway 219 bridge crossing.

The redundant supply, with an approximate capacity of 2 million gallons per day (mgd), would consist of a new groundwater well, on-site treatment for iron and manganese, on-site disinfection and approximately 1.3 miles of 12-inch diameter transmission mains from the new well to existing distribution at Highway 219 and NE Wyooski Road. Estimated project costs for supply development also include water rights permitting as well as geophysical and water quality exploration of the area to identify feasible well sites. It is assumed that exploration and supply development will take place over the next 10 years.

Although a new well in the Gearns Ferry area appears to be the most feasible option for redundant supply currently, it is anticipated that the City will evaluate other source water options as opportunities arise.

Treatment

The City currently uses sodium hypochlorite for disinfection at the Water Treatment Plant (WTP). The existing hypochlorite generator is showing signs of deterioration, such as, warped cell plates. City staff previously identified the need to replace the existing hypochlorite generator with new equipment. This improvement is expected to occur in the next two years.

Storage Reservoir

Based on projected future storage capacity deficiency presented in **Section 5, Table 5-1**, a new finished-water storage reservoir is recommended to serve future Zone 3 customers within the UGB. The proposed Bell Road Reservoir (CIP No. R-1) will ultimately serve Zone 2 and proposed Zones 3 and 4 beyond the 20-year planning horizon when and if development occurs in the North Hills URA. The proposed 1.7 million gallon (MG) reservoir is recommended for construction beyond 20-years. It is anticipated that the City will begin reservoir design within the 20-year timeframe. A portion of the estimated project cost is allocated to the 20-year timeframe in CIP **Table 7-5** based on the ratio of storage capacity needed to meet 20-year projected demands (0.24 MG) and the ultimate 1.7 MG recommended capacity.

Pump Stations

Based on the pumping capacity analysis presented in **Section 5, Table 5-2**, two new pump stations, Bell East (CIP No. P-1) and Bell West (CIP No. P2) are recommended to supply future Zone 3 and Zone 2 customers respectively. In the short term, both pump stations would supply constant pressure service to a small number of customers too high in elevation to be supplied by existing Zone 1. Following completion of the proposed Bell Road Reservoir (CIP No. R-1) and related transmission mains beyond the 20-year planning horizon, both stations would be converted to supply the reservoir.

The Bell West Pump Station is recommended for construction within the 5-year timeframe and Bell East within the 10-year timeframe. The Bell West Pump Station is needed to supply adequate fire flow to the Zone 2 expansion to Veritas School if the fire flow requirement at the school is determined to be greater than the existing 1,000 gallons per minute (gpm) available from the Oak Knoll Pump Station. The Bell East Pump Station will be needed as development occurs within the UGB along Zimri Drive north of the Allison Inn.

Distribution Mains

Table 7-2 and **7-3** present recommended water main projects for fire flow capacity and system expansion respectively. All recommended water main projects are illustrated on **Plate 1** in **Appendix A**.

Distribution Main Cost Estimates

Water main project costs are estimated based on unit costs by diameter shown in **Table 7-1**.

Table 7-1
Unit Cost for Water Main Projects

Pipe Diameter	Cost per Linear Foot (\$/LF)
8-inch	\$245
12-inch	\$290
18-inch	\$360

Assumptions:

1. Includes approximately 45 percent allowance for administrative, engineering and other project related costs
2. Ductile iron pipe with an allowance for fittings, valves and services
3. Surface restoration is assumed to be asphalt paving
4. No rock excavation
5. No dewatering
6. No property or easement acquisitions
7. No specialty construction included

Distribution Main Improvements for Fire Flow (M-1 to M-8, M-18)

As presented in **Section 5**, analysis using the City's water system hydraulic model revealed few piping improvements are needed to provide sufficient fire flow capacity and adequate service pressure within the existing water service area under existing and projected future demand conditions. Water main projects M-1 to M-8 and M-18 are recommended to address fire flow deficiencies under existing conditions. Project M-1 is recommended to replace several non-looped sections of 1- and 2-inch diameter mains along Hancock Street/Highway 99W through downtown Newberg. Several fire flow deficiencies and inadequate fire hydrant spacing and coverage were identified in this area. Water main improvements for fire flow are recommended for completion within the 5-year timeframe.

Estimated costs for these Zone 1 water main projects are allocated 34 percent to future growth based on the ratio of current to projected future Zone 1 MDD beyond 20 years including the City's UGB and North Hills URA.

**Table 7-2
Distribution Main Improvements for Fire Flow**

Project No.	Location	Diameter (inches)	Length (LF)	Estimated Project Cost
M-1	Downtown - Hancock St/Highway 99W from N Grant to Edwards St interconnect with existing side street mains, abandon existing 1-inch and 2-inch mains	8	2,250	\$552,000
M-2	NE Dayton Ave from W Johanna Ct south to existing hydrant – upsize 4-inch	8	410	\$101,000
M-3	Mission Dr from N College St west to existing hydrant at Mission Ct - upsize 6-in	8	940	\$231,000
M-4	Vittoria Square Apartments - Vittoria Way to Aquarius Blvd - upsize 4-inch	8	600	\$147,000
M-5	141 N Elliott Rd - upsize 6-inch fire line and loop with Highway 219	8	640	\$157,000
M-6	E North and Sherman Streets west of Villa Rd surrounding George Fox University Roberts Center and residence halls - upsize 4- and 6-inch mains	align="center">8	align="center">1,410	align="right">\$346,000
	East of Roberts Hall between E North and Sherman Streets - new 8-inch main loop			
M-7	South of Mountainview Dr between N Alice Way and Esther - upsize 6-inch	12	590	\$ 172,000
M-8	Wynooski Rd to Wastewater Treatment Plant hydrant	12	330	\$ 96,000
M-18	W Illinois St/Highwy 240, existing dead end near N Morton St to NE Chehalem Dr	8	832	\$ 400,000
Total Main Improvements for Fire Flow				\$ 2,202,000

Projects for Future System Expansion (M-9, M-14 to M-17, M-19)

Existing distribution main extensions and large diameter loops will be needed to serve new development areas within the City's UGB and North Hills URA including:

- Proposed Zone 3 water service within the UGB along NE Zimri Dr north of the Allison Inn (CIP No. M-9)
- Suction and discharge piping for proposed Bell West Pump Station (CIP No. P-2) to supply Zone 2 expansion north to Veritas School (CIP No. M-14 and M-15)
- Supply to proposed Bell Road Reservoir (CIP No. R-1) from Bell East and Bell West Pump Stations (CIP Nos. M-16 and M-17)
- Chehalem Drive water system extension (CIP No. M-19). This water main project was previously identified by the City to extend City water service from W Illinois/Hwy 240 north on NE Chehalem Drive to Columbia Drive.

Although many of these piping improvements will be constructed only as development warrants it is prudent for the City to have a long-term plan which sizes proposed facilities for the ultimate anticipated capacity need.

**Table 7-3
Distribution Main Improvements for System Expansion**

Project No.	Location	Diameter (inches)	Length (LF)	Estimated Project Cost	Timeframe
M-9	NE Zimri Drive from proposed Bell East PS (P-1) north to UGB	18	960	\$ 346,000	5-year
M-14	N College St from N Terrace Ct to proposed Bell West Pump Station (P-2)	12	830	\$ 241,000	5-year
M-15	N College St from proposed Bell West PS (P-2) to Veritas School	12	660	\$ 192,000	5-year
M-16	Bell East PS (P-1) to Bell Road Reservoir (R-1)	18	5,130	\$1,847,000	20-year and beyond
M-17	Bell West PS (P-2) to Bell Road Reservoir (R-1)	12	5,950	\$1,726,000	20-year and beyond
M-19	Chehalem Drive water system extension to Columbia Drive	8		\$600,000	5-year
Total Main Improvements for System Expansion				\$4,952,000	

Routine Main Replacement Program

In addition to distribution main projects to address capacity deficiencies and growth, the City should plan for routine replacement of pipes less than 6-inch diameter and aging pipes based on a 100-year life cycle. The goal of a routine pipe replacement program is to maintain reliable operation, without significant unexpected main breaks and leaks. Dead-end water mains under 6-inch diameter and less than 300 feet long with no fire hydrants are not recommended for replacement solely based on their diameter. **Figure 7-1** at the end of this section illustrates existing mains recommended for replacement within the 20-year planning horizon. Mains are assigned a first, second or third replacement priority based on the following:

- **Priority 1 Small and old** - mains both under 6-inch dia. and installed prior to 1936
- **Priority 2 Small** - mains under 6-inch diameter
- **Priority 3 Old** - mains installed prior to 1936

Table 7-4 summarizes the 20-year recommended pipe replacement program including total length of pipe for each diameter (size), the replacement diameter and estimated cost to replace. While costs will vary for each individual main depending on the piping location, surface conditions, and other constructability issues, this analysis provides a preliminary estimate of the required capital budget to execute an effective and proactive water main replacement program.

The average annual cost for the first 20 years of a 100-year replacement program is approximately \$736,000 annually. While it is understood that funding at this level for pipeline replacement may not be feasible today, it should be recognized that an adequately funded main replacement program is necessary to minimize the risk of failure for critical water system components that will result in significantly greater costs to repair and replace in the future. The routine main replacement cost included in the proposed CIP **Table 7-5** is the level of funding City staff determined to be available annually for this program.

**Table 7-4
20-Year Distribution Main Replacement Cost Summary**

Diameter (in)	Approx. Length (feet)	Replacement Diameter (in)	Estimated Replacement Cost
Less than 2	3,200	8	\$ 11,137,000
2	7,100		
4	13,900		
6	15,400		
8	5,800		
10	9,200	12	\$ 3,560,000
12	3,100		
18	60	18	\$ 21,000
Total Length	57,760	Total Cost	\$ 14,718,000

Planning Studies and Facility Assessments

Based on recent ground movement around the City’s water transmission bridge crossing at the WestRock property and subsequent slope evaluation by Northwest Geotech, Inc. the City has identified the need for further evaluation of slope stability on the north bank of the Willamette River from the transmission main bridge crossing at the WestRock Property east to the WTP. This WTP and Bridge Transmission Main Slope Stability Study is recommended in the next year.

A water system Seismic Resilience Study for the City is recommended in the next one to five years. The study is intended to analyze specific seismic hazards in the area based on local geology and topography, identify critical water system facilities and their vulnerabilities to these hazards, and map out a plan to strengthen existing facilities to withstand seismic hazards and/or develop redundant water facilities. The City’s seismic resilience study should be guided by the seismic response and recovery goals for water utilities presented in the Oregon Resilience Plan.

To comply with Oregon Water Resources Department (OWRD) requirements for water permit holders Newberg is required to complete an update of their Water Management and Conservation Plan (WMCP) every 10 years.

It is recommended that the City update this Water Master Plan (WMP) within the next 10 to 20 years. An update may be needed sooner if there are significant changes to the City’s water service area, supply or distribution system which are not currently anticipated.

Future water system planning projects are considered water system performance improvements which benefit all customers. Their estimated costs are allocated 44 percent to future growth based on the ratio of current to projected future system-wide MDD beyond 20 years including the City’s UGB and North Hills URA.

Other

Non-potable Distribution System

As briefly discussed in **Section 1**, Newberg maintains a non-potable “purple pipe” distribution system for irrigation. The system can be supplied from either the City’s Otis Springs source or reuse water from the Newberg Wastewater Treatment Plant (WWTP) effluent. Both non-potable sources are delivered to the Chehalem Glenn Golf Course pond and irrigation system. The publicly-owned golf course is the only existing customer of the City’s reuse system. Reuse pipes have been installed in parallel with other infrastructure and road projects at various locations within the Newberg water service area. However, the majority these non-potable mains are isolated pending future opportunities to connect and expand the reuse system.

As documented in **Appendix B**, expansion of the existing reuse system was evaluated considering both potential new customers with high irrigation use and most efficient interconnection of existing non-potable mains. It was determined that installation of new non-potable water piping from the Otis Springs supply line to serve existing and new development on the north end of the City would be a feasible extension of the existing non-potable system.

Construction of the proposed north non-potable water line could be completed in segments, the first of which would allow Otis Springs supply to serve the proposed Springbrook development. Once piping is complete through the Springbrook development, it may be connected to non-potable mains previously installed by the City in the immediate area. Installation for the first segment of approximately 4,500 linear feet (LF) of 8-inch diameter PVC piping is anticipated within the next 10 years.

Non-potable pumping improvements at Otis Springs are recommended to replace and upgrade aging infrastructure and allow for a constant pressure pumping configuration to serve the expanded non-potable service area.

Public Works Maintenance Facility Improvements

Prior to this Master Plan, the City had identified improvements to Public Works maintenance facilities needed to perform necessary operations and maintenance functions for Newberg's streets, wastewater, storm and water utilities. Costs and timelines for these phased improvements are described in the *Public Works Maintenance Facility Master Plan*. Work on these improvements is anticipated to begin next year and be completed by 2022.

Planned maintenance facility improvements are considered water system performance improvements which benefit all customers. Their estimated costs are allocated 44 percent to future growth based on the ratio of current to projected future system-wide maximum day demands beyond 20 years including the City's UGB and North Hills URA.

CIP Funding

The City may fund the water system CIP from a variety of sources including; governmental grant and loan programs, publicly issued debt and cash resources and revenue. The City's cash resources and revenue available for water system capital projects include water rate funding, cash reserves, and SDCs.

Water Rates

Currently, the City's Rate Review Committee evaluates water rates every two years based on the proposed 5-year CIP. An evaluation of water rates in support of the water system CIP will be completed as follow-on work to this WMP in concert with the next Rate Review Committee evaluation.

System Development Charges (SDCs)

An evaluation of SDCs in support of the proposed water system CIP was conducted as part of this WMP. A description of SDCs, their role in funding capital projects and a summary of the SDC evaluation is presented in the following paragraphs. The full text of the revised SDC Methodology is presented in **Appendix D**.

What is an SDC?

SDCs are sources of funding generated through development and system growth and are typically used by utilities to support capital funding needs. The charge is intended to recover a fair share of the costs of existing and planned facilities that provide capacity to serve new growth.

Oregon Revised Statutes (ORS) 223.297 – 223.314 defines SDCs for the State of Oregon and provides guidelines on the calculation and modification of SDCs, accounting requirements to track SDC revenues, and the adoption of administrative review procedures.

SDCs can be structured to include one or both of the following two components:

1. *Reimbursement Fee* – Intended to recover an equitable share of the cost of facilities already constructed or under construction.
2. *Improvement Fee* – Intended to recover a fair share of future, planned, capital improvements needed to increase the capacity of the system.

The reimbursement fee methodology must consider such things as the cost of existing facilities and the value of unused capacity in those facilities. The calculation must also ensure that future system users contribute no more than their fair share of existing facilities costs. Reimbursement fee proceeds may be spent on any capital improvements or debt service repayment related to the system for which the SDC is applied. For example, water reimbursement SDCs must be spent on water improvements or water debt service.

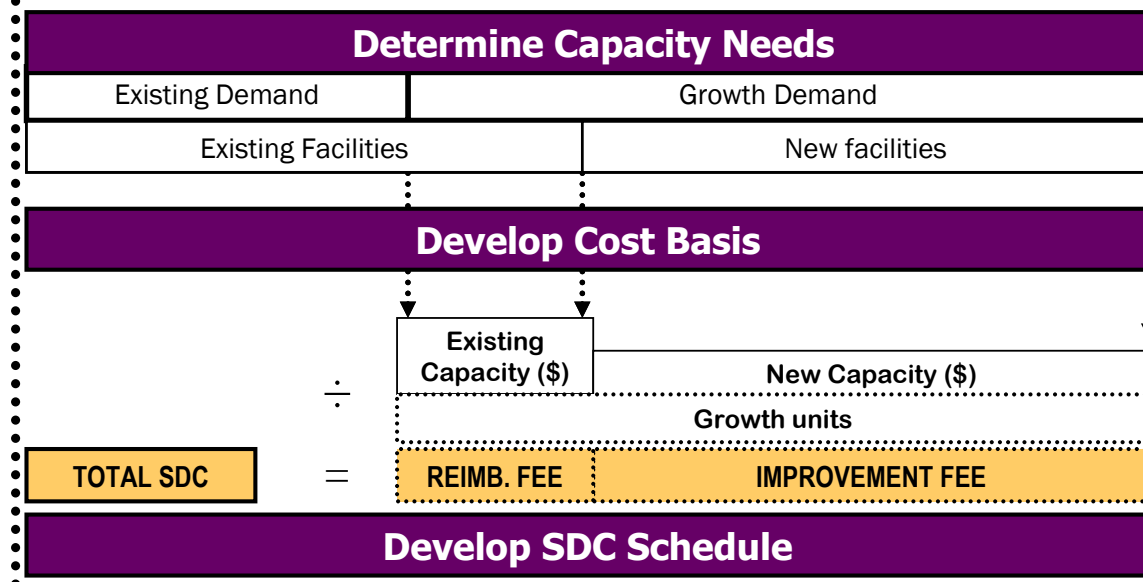
The improvement fee methodology must include only the projected cost of capital improvements needed to increase system capacity as identified in an adopted plan or list, like the water system CIP in this WMP. In other words, the cost of planned projects that correct existing deficiencies, or do not otherwise increase capacity, may not be included in the improvement fee calculation. Improvement fee proceeds may be spent only on capital improvements or related debt service that increase the capacity of the system for which they were applied.

The methodology for establishing or modifying improvement or reimbursement fees shall be available for public inspection 60 days prior to a public hearing.

Revised SDC Methodology Overview

The general methodology used to calculate water SDCs in Newberg is illustrated in **Figure 7-2**. It begins with an analysis of system planning and design criteria to determine growth’s capacity needs, and how they will be met through existing system available capacity and capacity expansion. Then, the capacity to serve growth is valued to determine the “cost basis” for the SDCs, which is then spread over the total growth capacity units to determine the system wide unit costs of capacity. The final step is to determine the SDC schedule, which identifies how different developments will be charged, based on their estimated capacity requirements.

Figure 7-2 Overview of SDC Methodology



Growth Capacity Needs

Capacity requirements are generally evaluated based on the following system design criteria:

- Maximum Day Demand (MDD) – The highest daily recorded rate of water production in a year. Used for allocating source, pumping and delivery facilities.
- Storage Requirements – Storage facilities provide three functions: operational storage, emergency storage and fire protection storage. Used for allocating storage facility costs.

System MDD is currently about 4.9 mgd, including both potable and non-potable use. Growth in MDD is projected to be about 3.9 mgd over the study period. For supply and delivery purposes, the potable and non-potable systems are evaluated on a combined basis, as collectively the systems will be used to meet future MDD.

Storage requirements are about 5.6 MG currently, and are limited to the potable system. Future storage requirements are expected to be 8.8 MG in Zone 1, and 1.7 MG in Zone 2. Pumping and storage requirements are evaluated separately for each zone.

Develop Cost Basis

The capacity needed to serve new development will be met through a combination of existing available system capacity (reimbursement fee) and additional capacity from planned system improvements (improvement fee). The value of capacity needed to serve growth in aggregate within the planning period is referred to as the “cost basis”.

Reimbursement Fee

The City’s historical investment in water system facilities totals about \$39 million (excluding vehicles and minor equipment costs). The growth share for each asset type is based on capacity needs described in the SDC methodology report in **Appendix D**. The reimbursement fee cost basis excludes any assets (like the sodium hypochlorite equipment) that will be replaced by planned capital improvements. The reimbursement fee cost basis totals \$16.3 million.

Improvement Fee

As with the existing facility costs, the costs of most planned improvements are allocated in proportion to future demands. The total improvement fee cost basis is about \$15 million.

Develop Unit Costs

The system-wide unit costs of capacity are determined by dividing the respective cost bases by the system-wide growth-related capacity requirements. The system-wide unit costs are then multiplied by the capacity requirements per equivalent dwelling unit (EDU) to yield the fees per EDU. In this case an EDU represents the base size meter (3/4-inch) in the City’s water system with an estimated capacity requirement of 605 gallons per day/EDU. This is the standard meter size for a single-family residential service.

Revised SDC

Based on the methodology described above, separate SDCs were established for potable and non-potable customers. The potable SDCs include the full unit cost per EDU, while the non-potable SDCs exclude the costs of storage, upper elevation pumping and other improvements which do not benefit potable system customers.

The total SDC per EDU (3/4-inch meter) for potable and non-potable are \$4,896 and \$3,216, respectively. The SDCs for larger meter sizes are scaled up based on the hydraulic capacity factors as summarized in **Table 5 in Appendix D**.

Summary

See Note 1

This section presented recommendations for improvement and expansion projects in the City's water distribution system. As presented in **Table 7-5**, the total estimated cost of these projects is approximately \$21.9 million through the 20-year planning horizon.

Approximately \$16.9 million of the total estimated cost is for projects needed within the 10-year timeframe and \$11.2 million of these improvements are required in the next 5 years.

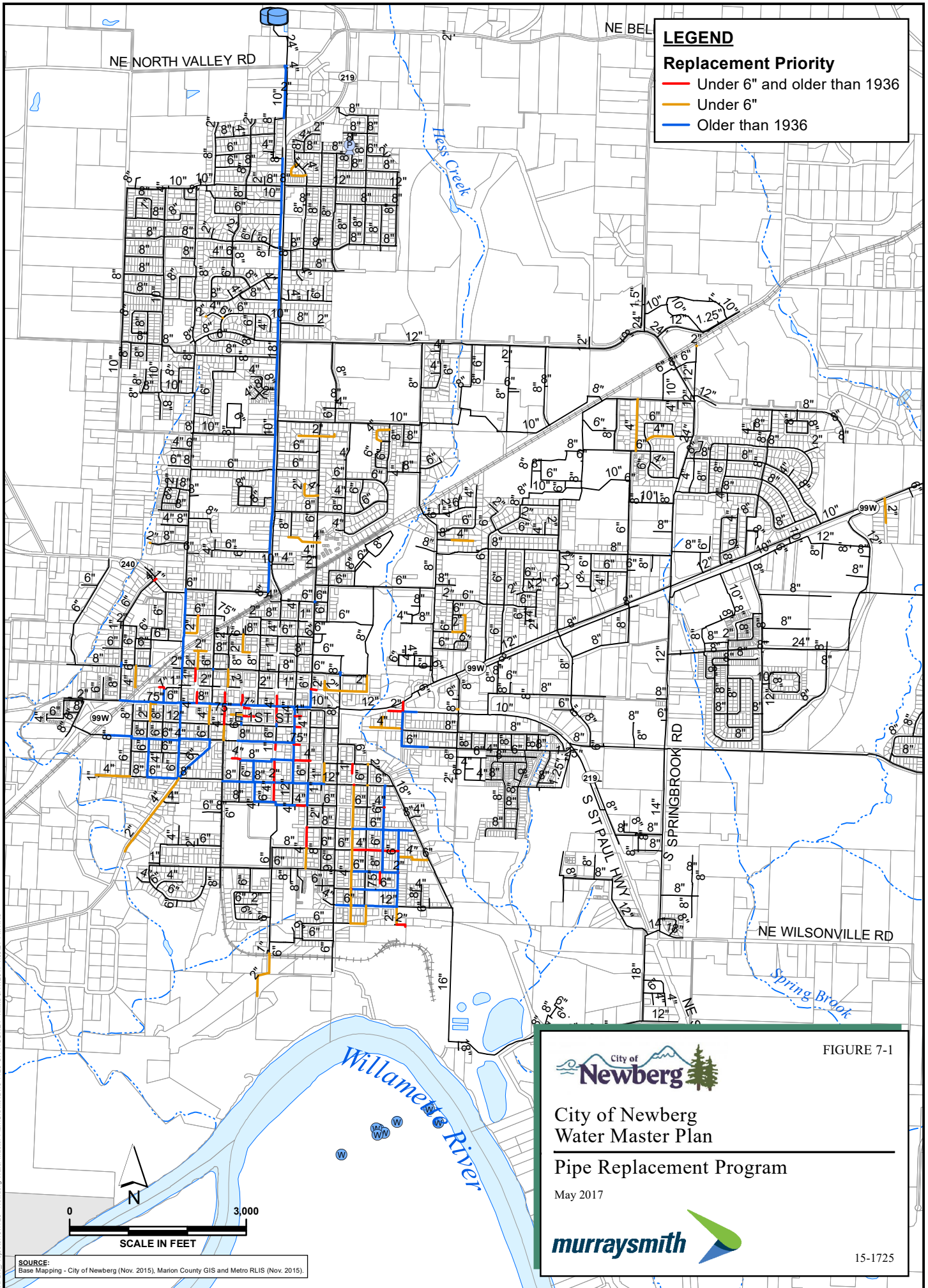
Note 1: See Appendix E, Addendum Riverfront Master Plan (Adopted 5/3/21)

Table 7-5
Proposed Capital Improvement Program (CIP) Summary *See Note 1*

Improvement Category	CIP No.	Project Description	CIP Schedule and Project Cost Summary					Preliminary Cost % to Growth
			5-year	10-year	20-year	Beyond 20 years	Estimated Project Cost	
			2017-2022	2022-2027	2027-2037			
Supply		2 mgd redundant supply development (source, treatment and transmission)	\$ 2,537,150	\$ 1,081,850			\$ 3,619,000	44%
		Hypochlorite generator	\$ 500,000				\$ 500,000	44%
		<i>Subtotal</i>	\$ 3,037,150	\$ 1,081,850	\$ -	\$ -	\$ 4,119,000	\$ 1,812,360
Pump Stations	P-1	Bell East Pump Station - Zone 3 constant pressure	\$ 725,000	\$ 725,000			\$ 1,450,000	97%
	P-2	Bell West Pump Station - Zone 2 constant pressure	\$ 1,450,000				\$ 1,450,000	97%
		<i>Subtotal</i>	\$ 2,175,000	\$ 725,000	\$ -	\$ -	\$ 2,900,000	\$ 2,813,000
Distribution Mains	M-1 thru M-8, M-18	Upsize existing mains and construct new distribution loops to improve fire flow capacity	\$ 2,202,000				\$ 2,202,000	34%
	M-9	NE Zimri Drive Zone 3 distribution backbone within UGB		\$ 346,000			\$ 346,000	97%
	M-14 and M-15	N College Street - N Terrace Street - proposed Bell West P.S. (P-2) - Veritas School	\$ 433,000				\$ 433,000	97%
	M-19	Chehalem Drive water system extension north to Columbia Drive	\$ 600,000				\$ 600,000	100%
		Routine Main Replacement Program ¹	\$ 1,702,000	\$ 1,500,000	\$ 3,000,000	\$ 133,798,000	\$ 140,000,000	0%
		<i>Subtotal</i>	\$ 4,937,000	\$ 1,846,000	\$ 3,000,000	\$ 133,798,000	\$ 143,581,000	\$ 2,104,310
Future High Elevation Water Infrastructure	R-1	1.7 MG Bell Road Reservoir - Zone 3			\$ 339,000	\$ 2,061,000	\$ 2,400,000	88%
	M-16	Zimri Drive East transmission main to Bell Road Reservoir			\$ 815,000	\$ 1,032,000	\$ 1,847,000	97%
	M-17	Bell Road west transmission main - N College Street to Zimri Drive			\$ 761,000	\$ 965,000	\$ 1,726,000	97%
		<i>Subtotal</i>	\$ -	\$ -	\$ 1,915,000	\$ 4,058,000	\$ 5,973,000	\$ 5,577,810
Planning		WTP and Bridge Transmission Main Slope Stability Study	\$ 150,000				\$ 150,000	44%
		Seismic Resilience Study	\$ 150,000				\$ 150,000	44%
		Water Management & Conservation Plan update	\$ 50,000		\$ 50,000		\$ 100,000	44%
		Water Master Plan update		\$ 250,000			\$ 250,000	44%
		<i>Subtotal</i>	\$ 350,000	\$ 250,000	\$ 50,000	\$ -	\$ 650,000	\$ 286,000
Other		North non-potable water line and Otis Springs pumping improvements		\$ 1,750,000			\$ 1,750,000	100%
		Public Works Maintenance Facility Master Plan	\$ 737,500				\$ 737,500	44%
		<i>Subtotal</i>	\$ 737,500	\$ 1,750,000	\$ -	\$ -	\$ 2,487,500	\$ 2,074,500
Capital Improvement Program (CIP) Total			\$ 11,236,650	\$ 5,652,850	\$ 4,965,000	\$ 137,856,000	\$ 159,710,500	\$ 14,667,980
			Annual Average CIP Cost					
			\$2,247,330	\$1,688,950	\$1,092,725			
			5-year	10-year	20-year			

1. Proposed CIP budget for Routine Main Replacement Program in the 20-year planning horizon are less than the identified cost of all recommended main replacements over that timeframe. This deficit is expected to be addressed in future CIP planning beyond the 20-year planning horizon.

Note 1: See Appendix E, Addendum Riverfront Master Plan (Adopted 5/3/21)



LEGEND

Replacement Priority

- Under 6" and older than 1936
- Under 6"
- Older than 1936

G:\PDX_Projects\151725 - Newberg Water Master Plan\GIS\MXD\15-1725-OR-FIGURE 7-1.mxd 5/17/2017 1:00:27 PM HAS

SOURCE:
 Base Mapping - City of Newberg (Nov. 2015), Marion County GIS and Metro RLIS (Nov. 2015).

FIGURE 7-1


 City of Newberg
 Water Master Plan
 Pipe Replacement Program
 May 2017


 15-1725

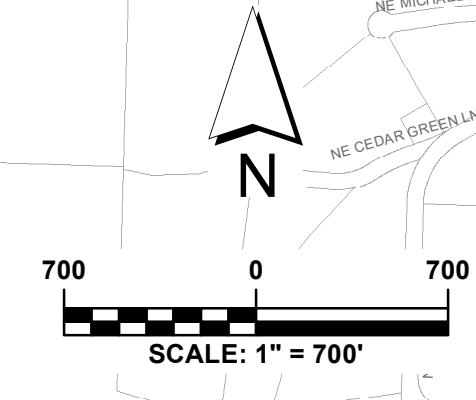


City of Newberg
 Water Master Plan
 Proposed Water System Map

May 2017



15-1725

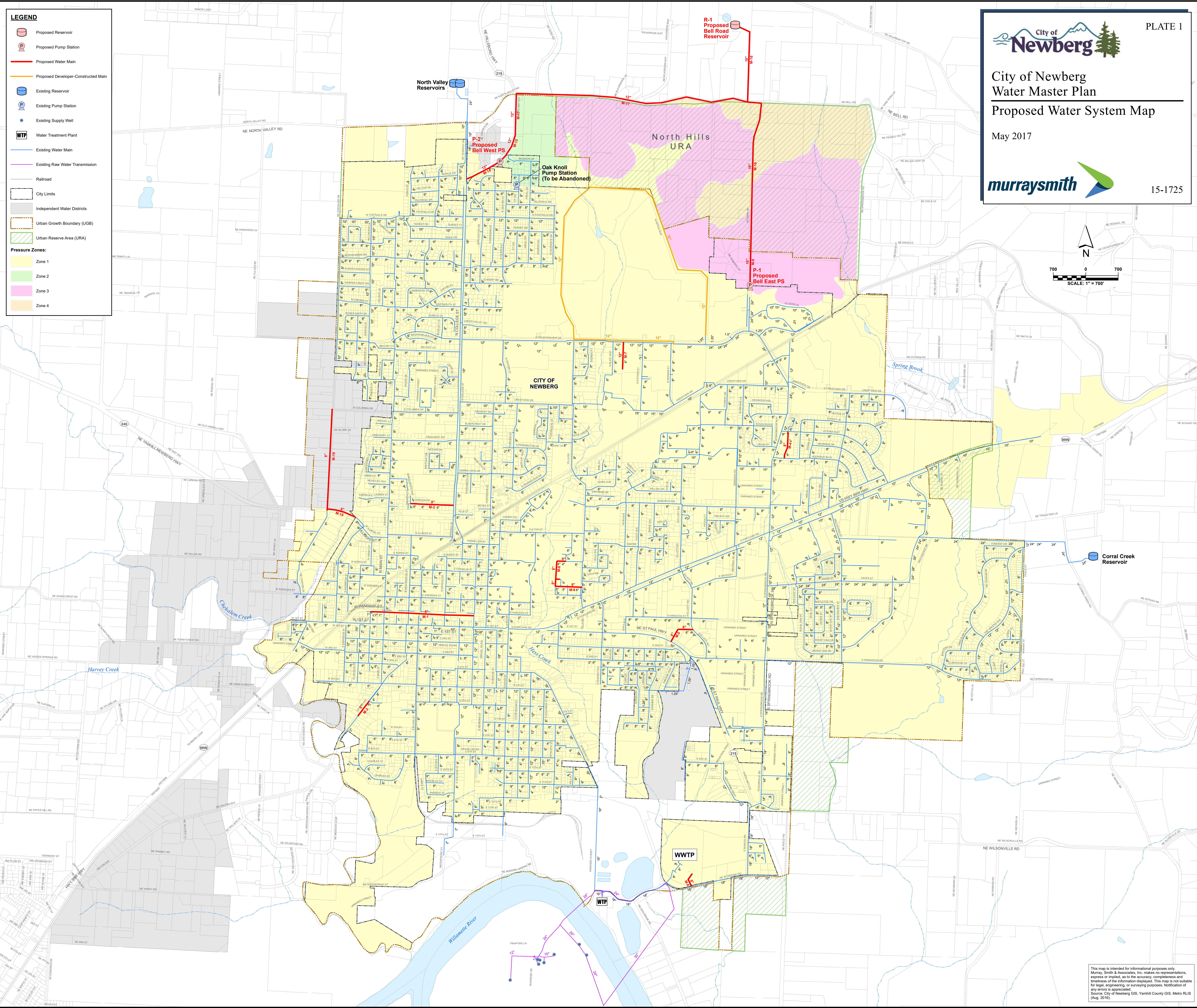


LEGEND

- Proposed Reservoir
- Proposed Pump Station
- Proposed Water Main
- Proposed Developer-Constructed Main
- Existing Reservoir
- Existing Pump Station
- Existing Supply Well
- Water Treatment Plant
- Existing Water Main
- Existing Raw Water Transmission
- Railroad
- City Limits
- Independent Water Districts
- Urban Growth Boundary (UGB)
- Urban Reserve Area (URA)

Pressure Zones:

- Zone 1
- Zone 2
- Zone 3
- Zone 4



This map is intended for informational purposes only. Murray, Smith & Associates, Inc. makes no representations, express or implied, as to the accuracy, completeness and timeliness of the information displayed. This map is not suitable for legal, engineering, or surveying purposes. Notification of any errors is appreciated. Source: City of Newberg GIS, Yamhill County GIS, Metro RLIS (Aug. 2016).



APPENDIX B
RECYCLED WATER USE EVALUATION
FOR
CITY OF NEWBERG

MAY 2017



Murraysmith
888 SW 5th Ave, Suite 1170
Portland, OR 97204
503.225.9010

SECTION B1 INTRODUCTION AND RECYLCED WATER SYSTEM

Purpose

The City of Newberg (City) has requested Murraysmith prepare this report to document the City's existing recycled water (reuse) treatment and distribution facilities, as well as to review and summarize current regulations dictating allowable uses for non-potable water generated from its wastewater treatment plant (WWTP). This report documents an evaluation of possible expansion of the existing recycled water facilities, including a conceptual level plan of the piping network required to supply recycled water to potential future customers. Conceptual level project cost estimates for development of the build-out recycled water system are also included for planning purposes.





Background

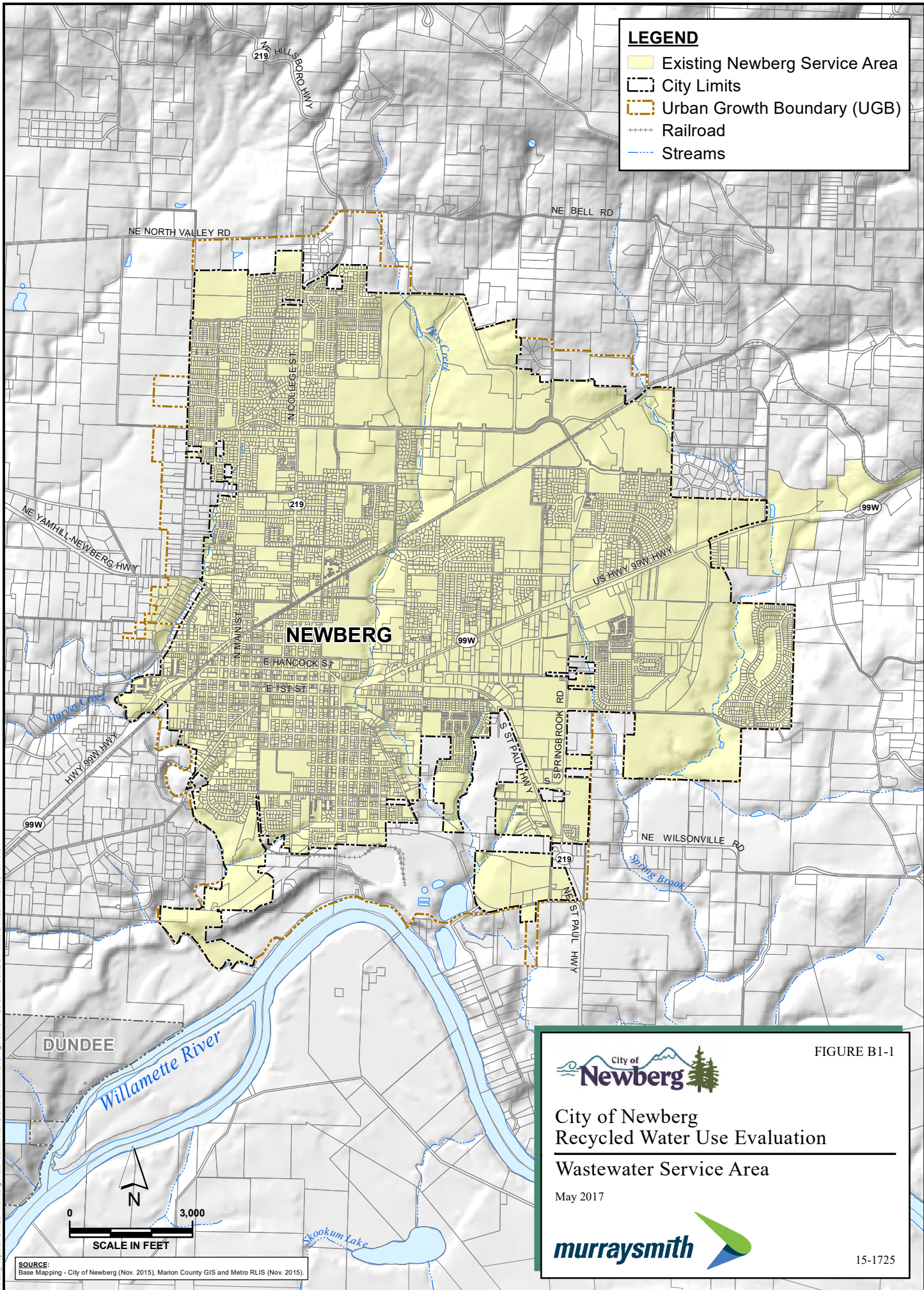
The City owns and operates a secondary wastewater treatment plant (WWTP) located at 2301 Wynooski Road in Newberg, Oregon. The WWTP has been in service since 1987. The facility provides wastewater collection and treatment services for residential, commercial, and industrial customers located with the city limits. A small number of residences located outside of the city limits are also served by the WWTP. A map of the City's service area limits is presented in **Figure B1-1**.

The WWTP is a Class IV oxidation-ditch type facility. The secondary treatment facility produces Class A compost product from its biological activated sludge plant, which the City sells under the name NEWGROW to the public throughout the year. Treated water discharged from the WWTP is either directed to the Willamette River or routed for additional treatment onsite to produce tertiary treated, recycled water. The tertiary membrane filtration reuse facility at the WWTP produces Class A effluent waters suitable for irrigating golf courses, school yards, and residential landscaping with minimal regulatory restrictions. Beneficial reuse of effluent is seasonal, because irrigation demands typically run from May through the first half of September.

Currently, the Chehalem Glenn Golf Course, located approximately one and a half miles northeast of the WWTP, is the sole recipient of the City's recycled water. Treated effluent is pumped from the WWTP through a dedicated 10-inch diameter recycled water main directly to a meter and associated private line to storage facilities on the golf course. Dedicated mains for recycled water are constructed of purple polyvinyl chloride (PVC) piping, termed in the industry as purple pipe; these purple pipes are not cross-connected with existing potable water mains. The City has been constructing limited segments of new purple pipe in association with all new underground utility installation projects.

LEGEND

-  Existing Newberg Service Area
-  City Limits
-  Urban Growth Boundary (UGB)
-  Railroad
-  Streams



© IPDX, Project#151725 - Newberg Water Master Plan/GIS/MXD/Reuse Eval Figures/15-1725-OR-FIGURE B1-1.mxd, 5/17/2017, 1:07:03 PM HAS

SOURCE:
Base Mapping - City of Newberg (Nov. 2015), Marion County GIS and Metro RLIS (Nov. 2015).



FIGURE B1-1

City of Newberg
Recycled Water Use Evaluation

Wastewater Service Area

May 2017



Wastewater Treatment Facilities

The City's secondary treatment facilities at the WWTP consist of a raw influent pump station, headworks, activated sludge oxidation ditches, secondary clarifiers, chlorine disinfection, dechlorination, effluent outfall, and biosolids composting. Disinfection of the effluent is performed with chlorine gas. Treated and disinfected effluent is dechlorinated with sodium bisulfite prior to flow measurement and discharge. Treatment plant effluent is discharged to the Willamette River or routed to an onsite tertiary membrane filtration facility for beneficial reuse.

The City constructed a tertiary membrane filtration reuse facility, called the Reuse Building, at the WWTP in 2008. The facility is designed to produce Class A recycled water meeting the standards defined in Oregon Administrative Rule (OAR) 340-55. The current capacity for the facility is 1 million gallons per day (mgd).

Existing Tertiary Water Treatment Facilities

The existing recycled water treatment system is comprised of a retrofitted chlorine contact basin at the end of the WWTP's secondary treatment chain; membrane raw water supply pumps; membrane filtration package system skids; membrane filter backwash systems; a single recycled water storage tank; and recycled water effluent pumps. The entire recycled water treatment system has been integrated into the City's Supervisory Control and Data Acquisition (SCADA) system to allow for optimizing controls. Individual components of the recycled water treatment system are discussed in further detail as follows. A schematic overview of the recycled water system is provided in **Figure B1-2**.

Chlorine Contact Basin

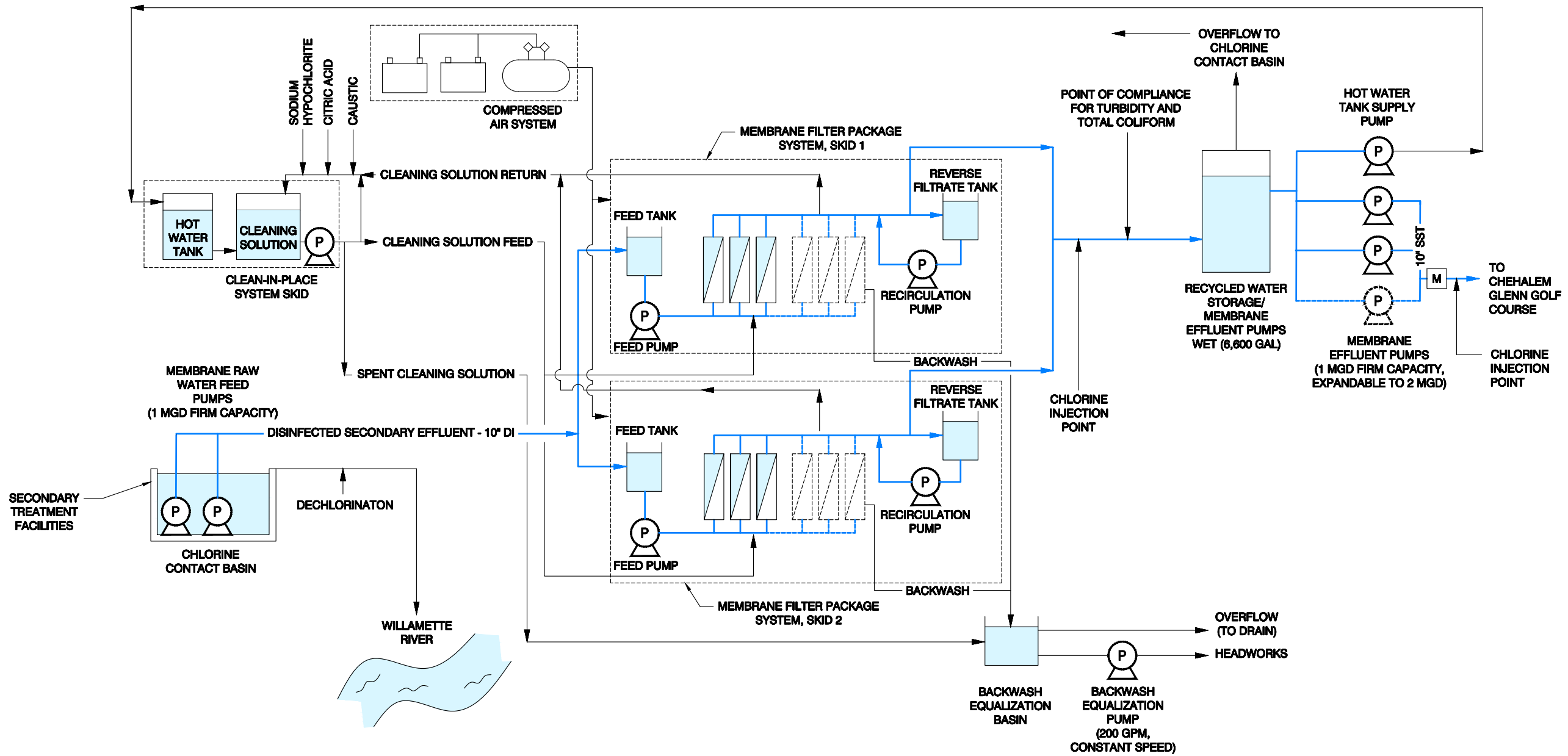
Following secondary clarification at the WWTP, plant flows are directed to a chlorine contact basin (CCB). Flows travel the length of the CCB at a rate designed to allow for sufficient chlorine contact time prior to discharging effluent to the downstream system. An overflow weir at the far end of the CCB directs flows through a dechlorination metering system prior to effluent discharge to the Willamette River. Membrane raw water feed pumps located within an existing pump wet well at the far end of the CCB provide supply to the WWTP's tertiary treatment facilities.

An operator-selected LOW setpoint at the CCB outfall weir and a HIGH setpoint below the top of CCB wall maintain desired water elevations within the CCB. An additional hard-coded LOW-LOW level setpoint has been provided to maintain an acceptable water surface level above the membrane raw water feed pumps to minimize the potential for pump damage.

Membrane Raw Water Supply Pumps

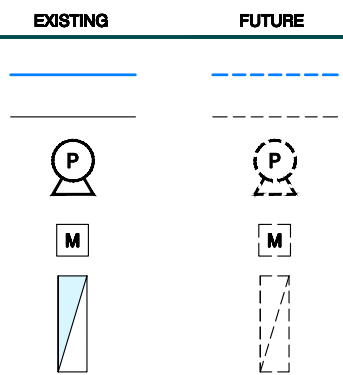
Two constant speed vertical turbine pumps installed within the CCB act as the membrane raw water feed pumps. The pumps provide a firm capacity of approximately 700 gallons per

C:\P\Projects\151725 - Newberg Water Master Plan\1.1 Non-Potable Water Re-Use Evaluation\Figures\2016-06-15\US-1725-41-08-F108E B1-2.dwg PROCESS Flow DIAGRAM 5/16/2017 7:24 PM DWG 2.0a (US Tech)



LEGEND

- MAIN PROCESS FLOW
- SUPPORTING PROCESS FLOW
- PUMP
- ELECTROMAGNETIC FLOW METER
- MEMBRANE FILTER



ABBREVIATIONS

- | | |
|-----|-------------------------|
| DI | DUCTILE IRON |
| GAL | GALLONS |
| GPM | GALLONS PER MINUTE |
| MGD | MILLION GALLONS PER DAY |
| SST | STAINLESS STEEL |

FIGURE B1-2

CITY OF NEWBERG

**TERTIARY TREATMENT
PROCESS FLOW DIAGRAM**

May 2017

15-1725

minute (gpm) (1 mgd). The pumps discharge flows to two membrane filtration package system skids, located in the neighboring Reuse Building, via a 10-inch diameter ductile iron (DI) header pipe for further treatment.

Raw water pumping rates are determined by reuse water production rates input into the SCADA system by the operator. The pumps will stop once SCADA no longer receives the raw water production request or the hard-coded LOW-LOW alarm in the CCB is reached. If the pumps are stopped from a programmed shutoff, they will remain off until the water level within the CCB rises to a hard-coded setpoint above the pumps.

Membrane Filtration Package System Skids

Chlorinated secondary effluent pumped from the CCB to the Reuse Building is delivered to two membrane filtration package system skids installed in parallel off of the 10-inch diameter DI header supply line. The two expandable membrane filter trains share a single control panel to manage all filtration and cleaning processes. The system is currently programmed to produce 200 to 800 gpm (0.3 to 1.15 mgd) of recycled water.

The first component for each of the package systems is an open-air membrane filter feed tank. From this tank, a feed pump provides pressurized flow to the membrane filtration systems. Each membrane module contains thousands of hollow tubes, which are the filtration membranes. Once passed through the filtration membranes, the treated water is delivered to an open-air reverse filtrate tank at the end of each package skid or to the recycled water storage tank. The filtrate tank supplies a recirculation pump, which provides pressurized water for backwashing the filtration membranes, as needed.

Each membrane module is backwashed at regular intervals throughout the day to dislodge and remove residual material left on the outside of the membrane. Compressed air is run from the inside of the filtration membrane installation during backwash to aid in the cleaning. Similar, though more intense, cleaning cycles are performed several times a day, and an even stronger clean-in-place (CIP) chemical cleaning of the membranes is conducted on a monthly basis. The CIP process is supplemented by hot water (90 to 100 degrees F) provided via a system consisting of a hot water storage tank with an internal electrical heating system provided by the membrane filter supplier. Backwash and cleaning cycles for filtration membranes are initiated by pressure loss across the membranes and controlled by the membrane filter system package control panels. Filter backwash flows are directed to a backwash equalization basin, where flows are pumped back to the WWTP headworks via a 200 gpm constant speed submersible pump.

Recycled Water Storage Tank

Tertiary treated effluent from both membrane filtration package treatment skids is combined into a single pipe for delivery to the recycled water storage tank. This combined effluent pipe is the regulatory point of compliance for recycled water quality produced by the facility. The effluent pipe is equipped with a turbidity meter and a grab sample valve for monitoring total coliforms. In the event of high turbidity in the recycled water, the downstream

membrane effluent pumps will shut down. Chlorine solution may be injected into this line to provide a chlorine residual in the effluent water, as well as to control water quality within the recycled water storage tank.

The recycled water storage tank is approximately 6,600 gallons in volume. The tank is located outside and adjacent to the Reuse Building. The tank functions as the wet well for the membrane effluent pumps.

Water failing to meet regulatory standards and overflows from the recycled water tank are routed back to the inlet structure of the CCB. Water level in the tank is monitored by a pressure differential transmitter and relayed by SCADA, which will alarm at operator-selected HIGH and LOW setpoints. Float level switches provide redundant monitoring of water level in the tank.

Membrane Effluent Pumps

Two dry pit centrifugal horizontal end suction pumps are installed adjacent to the recycled water storage tank for distributing membrane filter effluent. The pumps provide a firm capacity of up to approximately 700 gpm (1 mgd). The pumps are adjustable speed and can be set by operators to maintain a constant level in the recycled water storage tank. The pumps discharge to a 10-inch diameter stainless steel header before combining in a single 10-inch diameter recycled water pipeline to provide irrigation water to Chehalem Glenn Golf Course.

If the pumps fail or are turned off, flows will back up into the recycled water storage tank. Tank overflows are routed back to the inlet structure for the CCB. Flows from the membrane filter effluent pumps are measured by an electromagnetic flow meter as prior to leaving the WWTP site. Chlorine solution may be added to the membrane filter effluent pump discharge/recycled water pipeline to provide a chlorine residual in the recycled water supplied to the Chehalem Glenn Golf Course.

Standby Power Generator

The Reuse Building is connected to an onsite 2 megawatt (MW) standby power generator, allowing the facility to remain completely functional in the event of power outage. The generator has been provided to meet with DEQ requirements for emergency power generation for recycled water treatment facilities. In the event the power generation facilities should fail, the recycled facility will not be operational. Recycled water will not be provided to customers, nor will it leave the facility unwanted, as the tertiary treated effluent must be discharged through the membrane effluent pumps to reach its customers.

Improvements for Expansion

The WWTP's tertiary treatment facilities were designed to allow for future expandability, upgrading capacity from the current 1 mgd to a future 2 mgd. For the City to reach this future

maximum capacity for providing reused water, the various improvements to the existing facilities which follow will be necessary.

Membrane Raw Water Supply Pumps

The two existing 1 mgd membrane raw water supply pumps will need to be removed and replaced with two new pumps sized with an individual capacity of 2 mgd. It is understood the existing pumping pit within the CCB is not of sufficient size to allow for a third pump installation to boost the current capacity. Replacement of the existing pumps will provide the City with 2 mgd of firm raw water pumping capacity.

Membrane Filtration Package System Skids

The existing membrane filtration package system skids have expandable membrane filter trains. As the two package systems combine to currently produce a maximum of 800 gpm (1.15 mgd) of recycled water, the amount of membrane filtration will need to nearly double. As the system build-out capacity of 2 mgd was noted in design of the system skids, there should be adequate capacity in the skids to accommodate this capacity upgrade.

Membrane Effluent Pumps

An additional pump with a capacity of approximately 700 gpm (1 mgd) will need to be installed adjacent to the two existing membrane effluent pumps to provide a firm recycled water pumping capacity of 2 mgd. Accommodations will need to be made at the existing 10-inch diameter stainless steel discharge header to allow for the third pump.

The existing 10-inch diameter reuse water pipeline which provides irrigation water to Chehalem Glenn Golf Course has been previously sized to accommodate the future 2 mgd membrane effluent pumps discharge. Maximum flows may be anticipated to be approximately 6 feet per second in this line.

Summary

This section provided documentation of the City's existing wastewater treatment facilities, including a schematic overview and detailed discussion on the various components of the recycled water system. Existing tertiary treatment facilities are expandable from 1 mgd to 2 mgd should future demands require.

SECTION B2

REGULATORY JURISDICTION

The design, construction, and operation of the City of Newberg's (City's) wastewater treatment plant (WWTP) and effluent reuse system fall under the jurisdiction of the State of Oregon's Department of Environmental Quality (DEQ). The DEQ regulates the City's WWTP under an existing National Pollution Discharge Elimination System (NPDES) waste discharge permit issued in 2004. The permit was modified in 2008 to include reuse of treated effluent for golf course irrigation at the Chehalem Glenn Golf Course and impose thermal loading limits for discharge to the Willamette River. The City's existing NPDES permit expired May 31, 2009 and is currently on administrative extension, as no additional modifications to the prior permit have been requested by the City.

The WWTP's tertiary treatment facility is designed to produce Class A recycled water meeting the standards defined in Oregon Administrative Rule (OAR) 340-55 and summarized as follows.

Treatment

Class A recycled water must be oxidized, filtered, and disinfected prior to distribution. The recycled water must meet the quantitative criteria following treatment as follows.

Turbidity

Prior to disinfection, the wastewater must be treated with a filtration process. Turbidity of the water must not exceed an average of 2.0 nephelometric turbidity units (NTU) within a 24-hour period, 5 NTU for more than five percent of the time within a 24-hour period, and 10 NTU at any time.

Monitoring for turbidity must occur, at a minimum, on an hourly basis during recycled water production.

Total Coliforms

Following disinfection, Class A recycled water must not exceed a median of 2.2 total coliform organisms per 100 milliliters (mL), based upon results of the previous seven days in which analysis has been completed. No single sample shall have more than 23 total coliform organisms per 100 mL.

Monitoring for total coliform organisms must occur, at a minimum, on a once per day basis during recycled water production.

Additional Monitoring Requirements

The DEQ has requested the City monitor the following water quality parameters daily during the production of recycled water:

- Flow volume
- Chlorine residual
- pH
- Nutrient content

Beneficial Purposes

It is the policy of the DEQ to encourage the use of recycled water for domestic, agricultural, industrial, recreational, and other beneficial purposes in a manner which protects public health and the environment of the state. The term beneficial purpose is defined by the DEQ as a purpose where recycled water is utilized for a resource value, such as nutrient content or moisture, to increase productivity or to conserve other sources of water.

Class A recycled water is the highest quality of recycled water which may be produced, acceptable for use in all beneficial purposes which lower quality Class B, C, and D recycled water are allowable. Class A recycled water may be used for the following beneficial purposes where all other rules of OAR 340-55 are met:

- Irrigation of any agricultural or horticultural use, including the following:
 - Processed food crops
 - Orchards or vineyards, if an irrigation method is used to apply recycled water directly to the soil
 - Firewood, ornamental nursery stock, Christmas trees, sod, or pasture for animals
 - Growing fodder, fiber, seed crops, or commercial timber
- Landscape irrigation of parks, playgrounds, school yards, residential landscapes, golf courses, cemeteries, highway medians, industrial or business campuses, or other landscapes accessible to the public
- Commercial car washing or fountains when the water is not intended for human consumption
- Water supply source for restricted and non-restricted recreational impoundments
- Artificial groundwater recharge by surface infiltration methods or by subsurface injection in accordance with OAR Chapter 340, division 44
- Stand-alone fire suppression systems in commercial and residential buildings, non-residential toilet or urinal flushing, or floor drain trap priming
- Industrial, commercial, or construction uses limited to: industrial cooling, rock crushing, aggregate washing, mixing concrete, dust control, non-structural firefighting using aircraft, street sweeping, or sanitary sewer flushing

It should be noted where sprinkler irrigation is to use Class A recycled water, recycled water must not be sprayed onto an area where food is being prepared or served, or onto a drinking fountain. Additionally, when recycled water is to be used for agricultural, horticultural or landscape purposes where spray irrigation may be used, or for an industrial, commercial, or construction purposes, the public and personnel at the use area must be notified and signage must be posted noting recycled water is being used and that is not safe for drinking.

Operational Requirements

The operations of a recycled water facility must meet certain requirements set forth by the DEQ, which are summarized as follows.

Recycled Water Use Plan

All use of recycled water must conform to a recycled water use plan approved by DEQ. A recycled water use plan details how the wastewater treatment system owner will comply with the requirements of OAR 340-055. Existing treatment systems and methods must be detailed in the plan. Monitoring and sampling procedures must be documented, operational contingency plans are to be detailed, and estimates for recycled water production are to be documented in the plan.

The City is currently operating under the DEQ-approved *Recycled Water Use Plan for the Chehalem Glenn Golf Course* (CH2M Hill, August 2008). Should the City wish to modify existing systems and/or methods for treatment of its recycled water, or should the City want to add new customers or distribution systems to its existing recycled water system, an updated recycled water plan would be required for review and approval by DEQ.

Facility Requirements

Facilities treating and distributing recycled water must have the following systems in place for DEQ approval.

- *Alarm devices.* In the event of power loss or failure of process equipment essential to the proper operation of the treatment system, alarm devices are required to provide warning.
- *Standby power.* A recycled water treatment system must have sufficient standby power to fully operate all essential treatment processes, unless otherwise approved in writing by DEQ.
- *Redundancy.* A sufficient level of redundant systems and monitoring equipment must be in place to prevent inadequately treated water from being used or discharged from the facility.
- *Cross-connection control.* Connection between a potable water supply system and a recycled water distribution system is not authorized, unless the connection is provided through a DEQ-approved air gap separation. Additionally, all piping and appurtenances associated with a recycled water use system which is outside the

treatment building must be constructed and marked in a manner which prevents cross-connection to a potable water system.

Blending Recycled Water

The DEQ may approve on a case-by-case basis blending recycled water with other water for distribution to non-potable water systems. Before blending recycled water, the wastewater treatment system owner must obtain written authorization from DEQ. In obtaining authorization, the wastewater treatment system owner must submit the following information for review and approval:

- An operations plan
- A description of any additional treatment process
- A description of blending volumes detailed by source
- A range of final recycled water quality at the compliance point identified in the NPDES permit

Waters of the State

No discharge of recycled water is allowed to waters of the state. All recycled waters are to be stored and/or distributed for beneficial purposes. Waters of the state are defined by DEQ as lakes, bays, ponds, impounding reservoirs, springs, wells, rivers, streams, creeks, estuaries, marshes, inlets, canals, the Pacific Ocean within the territorial limits of the State of Oregon, and all other bodies of surface or underground waters, natural or artificial, inland or coastal, fresh or salt, public or private (except those private waters which do not combine or effect a junction with natural surface or underground waters) that are located wholly or partially within or bordering the state or within its jurisdiction.

Summary

The WWTP's tertiary treatment facility is designed to produce Class A recycled water, as defined in OAR 340-55. Class A recycled water is the highest quality of treated water which may be produced, acceptable for many beneficial uses. The operational requirements and beneficial purposes for recycled water production have been provided in this section.

SECTION B3

EXISTING AND FUTURE DEMANDS FOR NON-POTABLE WATER

This section presents existing and projected future non-potable water demands for the City of Newberg's (City's) service area. Demand forecasts are developed from review of historic water use records, as well as from discussions with City staff, to determine likely future non-potable water customers. Potential future demands focus on supplying water for irrigation of residential, industrial and commercial customers.

Service Area

Existing

The sole customer for the City's non-potable water is the Chehalem Glenn Golf Course. The course's 18 holes and driving range total approximately 188 acres, with about 120 acres of the facility being irrigated turf. The golf course's irrigation system has been installed such that it may receive water from any combination of three available sources: recycled water from the City's wastewater treatment plant (WWTP), non-potable water from Otis Springs, and City potable water.

Future

The study area for potential future non-potable water uses include all areas within the city limits and the urban growth boundary (UGB). Areas located outside of the UGB were not investigated, as the City has no reasonable timetable for bringing these properties into the service area.

Non-Potable Water Resources

Wastewater Treatment Plant

Current production capacity at the City's WWTP for recycled, or tertiary treated, water is approximately 1 million gallons per day (mgd). The facility was designed and constructed to allow for expansion of capacity up to 2 mgd.

Otis Springs

Otis Springs is located northeast of Newberg's city limits, directly north of Highway 99E at the foot of Rex Hill. The spring was once used as a supply source for the City's potable water system; however, the Department of Environmental Quality (DEQ) determined Otis Springs to be surface water influenced, and it is no longer connected to the City's potable water system. Pumps at Otis Springs are run based on water level of the irrigation water storage ponds at the Chehalem Glenn Golf Course, and production is metered at both the spring and the golf course. The City reports a production capacity for Otis Springs of up to 0.5 mgd, though maximum flows seen in historical records approach only 0.3 mgd.

Historical Non-Potable Water Demand

The only purchaser to date for the City's non-potable water is the Chehalem Glenn Golf Course. The golf course's non-potable water demand is solely for irrigation of turf. The facility's irrigation demand is met by a combination of the WWTP's recycled water and flows from Otis Springs.

Production records from the City's two non-potable water sources were evaluated to determine historical non-potable water system demands. Daily recycled water production figures from the WWTP were available from the City's Supervisory Control and Data Acquisition (SCADA) system. In the absence of daily production records for Otis Springs, daily production rates were calculated for individual months by averaging total monthly supply over the number of days in each month. Records indicate non-potable water irrigation demands typically begin on or around the start of June and continue through the middle of September, making for an average duration of approximately 16 weeks, or 112 days, for the irrigation season. **Figure B3-1** provides a graphical representation of the daily non-potable water demands for the golf course over full irrigation seasons for the years 2013-2015, with total demand also being separated by individual sources.

The graphs in **Figure B3-1** demonstrate the highly variable nature of non-potable water demand over an irrigation season. The data shows a typical seasonal peak day of approximately 0.6 mgd, with most of these flows being provided as WWTP recycled water. Large spikes in demand seen in July may be accounted for in the golf course banking irrigation water at its onsite storage ponds in preparation of ceasing flows from Otis Springs in the following month of August. A minor modification in the golf course's operations would allow them to begin banking non-potable water for irrigation earlier in the season, likely resulting in a more even distribution of peak demands over the season. Average irrigation season demands total approximately 42 million gallons (MG), with an average daily demand of 0.4 mgd.

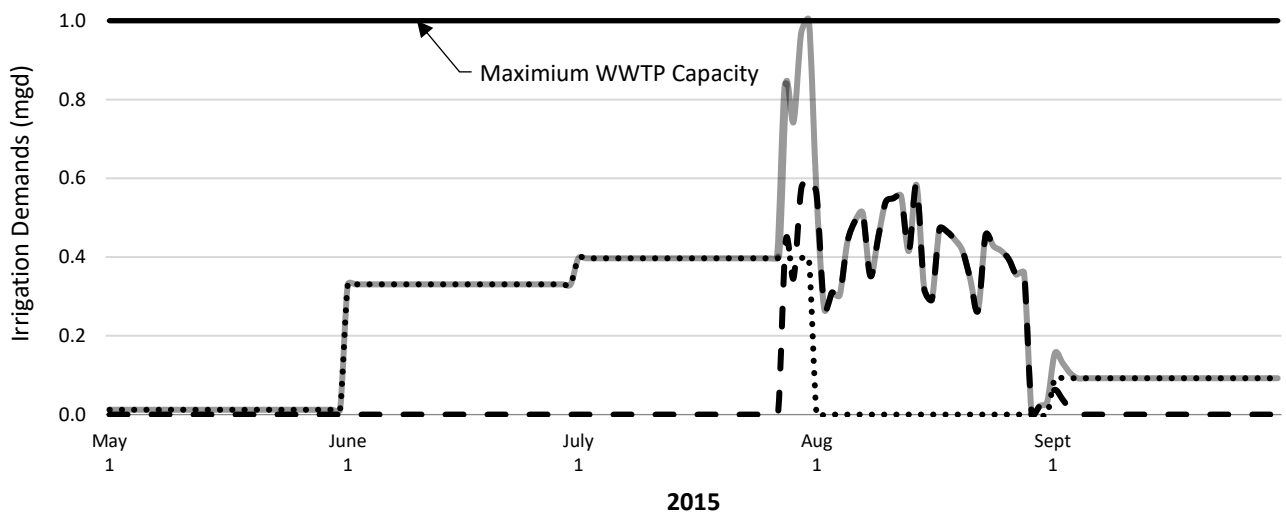
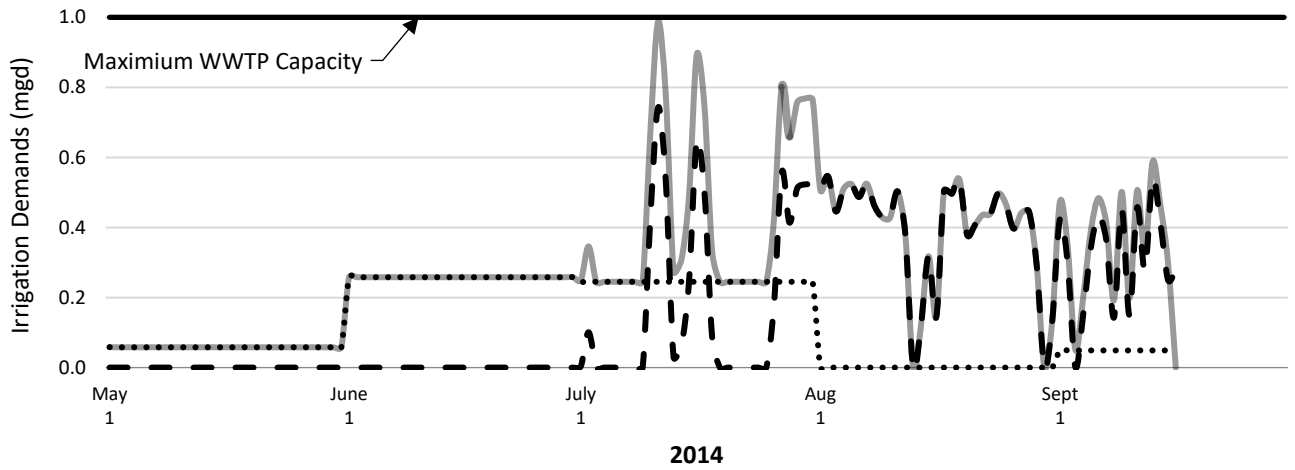
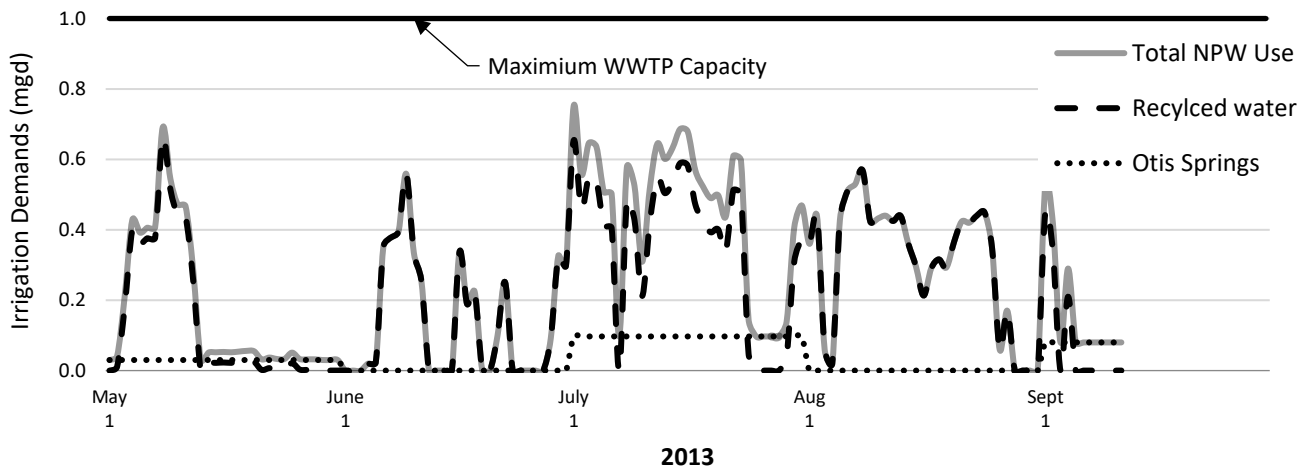


Figure B3-1: Irrigation demands, 2013 - 2015

Future Non-Potable Water Customers and Demand Forecast

Demand forecasts for the City's non-potable water have been developed from a review of historic irrigation water service meter records to determine likely future non-potable water distribution system customers. Those potable water service customers which have existing water meters classified by the City solely for irrigation purposes were examined to determine an overall irrigation demand which may be satisfied using non-potable water. Discussions with City staff were then used to determine the likelihood of an existing irrigation water meter owner to take part in any future expanded non-potable water distribution system. Additionally, a property's vicinity to existing non-potable water distribution infrastructure was used as part of this evaluation.

In reviewing irrigation water service meter records for the individual 2013, 2014, and 2015 seasons, it was determined overall irrigation demands remain consistent on a year-to-year basis. For the purpose of this evaluation and determining potential future irrigation water demands, it has been assumed future irrigation demands for individual properties will remain similar to those currently being recorded. Subsequently, for this evaluation, overall demands for the City's non-potable water will only increase with the addition of new irrigation customers along any new distribution system.

The City has approximately 100 water meters classified for irrigation use. This evaluation looked at those irrigation water services with annual metered use of approximately 450,000 gallons (average daily demand of 3,250 gallons per day) or greater. Irrigators using a minimum of 450,000 gallons annually are within the top 40 percent of the City's irrigation water users, with flows of a high enough volume to warrant interest in any expansion of the City's non-potable water program. In instances where one owner had multiple irrigation water service meters distributed over a single location, individual meter flows were summed into one total demand figure. For instance, George Fox University has 8 irrigation meters across a single large campus, and this customer's use is reported as a single irrigation demand.

Irrigation water demands for the City's top users are summarized in **Table B3-1** for the 2013, 2014, and 2015 seasons. Information on the City's top irrigators provided in **Table B3-1** includes a ranked listing of users from high to low annual consumption, City water meter account number, property owner, physical location of water meter, and total consumption of water in gallons per year. The City's top irrigators, including the Chehalem Glenn Golf Course, account for approximately 89 MG (0.80 mgd) in current irrigation water and potential non-potable water demand. With the addition of the proposed Springbrook Development within the north end of the city limits, which has the potential to become the City's second largest non-potable water consumer, total irrigation season demands increase to nearly 100 MG (0.89 mgd).

**Table B3-1
Irrigation Water Demand Summary**

User Ranking	City Account No.	Owner	Physical Address	2013 Consumption (gallons)	2014 Consumption (gallons)	Consumption (cf) (sum for 2015)	2015 Consumption (gallons)	Average Annual Consumption (gallons)
1	018486-000	CHEHALEM GLENN GOLF COURSE, RECYCLED WATER SOURCE	4501 E FERNWOOD RD	31,463,872	24,093,828	1,944,600	14,545,608	23,367,769
	014711-000	CHEHALEM GLENN GOLF COURSE, OTIS SPRINGS SOURCE	4501 E FERNWOOD RD	5,473,385	18,878,383	4,218,558	31,554,814	18,635,527
2	--	SPRINGBROOK DEVELOPMENT	--	--	--		--	10,860,000
3	Multiple	BPM HOA MANAGEMENT	SPRINGBOOK OAKS	6,654,208	6,534,528	716,400	5,358,672	6,182,469
4	Multiple	GEORGE FOX UNIVERSITY	414 N MERIDIAN ST	5,434,220	4,123,724	526,500	3,938,220	4,498,721
5	Multiple	NEWBERG S.D. / NEWBERG HIGH SCHOOL	2400 DOUGLAS AVE, ATHLETIC FIELD	3,837,988	3,880,624	350,500	2,621,740	3,446,784
6	000265-001	CHEHALEM PARK & REC / DARNELL WRIGHT SOFTBALL COMPLEX.	303 W FOOTHILLS DR	2,487,100	3,547,016	399,400	2,987,512	3,007,209
7	009758-000	FRIENDSVIEW MANOR	1301 E FULTON ST UNIT C	2,597,056	2,871,572	436,600	3,265,768	2,911,465
8	001936-000	HAZELDEN BETTY FORD FOUNDATION	1901 ESTHER ST	2,951,608	1,327,700	329,300	2,463,164	2,247,491
9	019966-000	EMERITUS LIVING	3802 HAYES ST	2,700,280	1,322,464	336,700	2,518,516	2,180,420
10	019222-000	ARBOR OAKS MEMORY CARE	317 WERTH BLVD	1,605,208	2,462,416	172,900	1,293,292	1,786,972
11	010588-000	NEWBERG S.D. / JOAN AUSTIN ELEMENTARY	2200 N CENTER ST	2,561,900	2,062,984	96,000	718,080	1,780,988
12	000090-000	NEWBERG S.D. / CHEHALEM VALLEY MIDDLE SCH	403 W FOOTHILLS DR	3,286,712	946,968	107,900	807,092	1,680,257
13	002096-001	NEWBERG S.D. / MT VIEW MID SCHOOL	2015 EMERY DR	2,143,020	1,673,276	120,500	901,340	1,572,545
14	018955-000	ALLISON INN AND SPA	2525 ALLISON LANE-ZIMRI DR-2" METER	362,032	3,186,480	61,100	457,028	1,335,180
15	001201-003	CHEHALEM PARK & REC / J JAQUITH FIELDS	1215 N COLLEGE ST	880,396	1,403,248	180,800	1,352,384	1,212,009
16	004804-000	FRED MEYER	3300 PORTLAND RD	1,095,820	1,306,008	146,200	1,093,576	1,165,135
17	004974-000	PGE	1101 WILSONVILLE RD	783,156	828,036	230,200	1,721,896	1,111,029
18	014221-000	OAK MEADOWS @ NEWBERG	3897 OAK MEADOWS LP	1,013,540	1,075,624	121,900	911,812	1,000,325
19	023433-001	NO OWNER ON RECORD	NO ADDRESS ON RECORD		759,220	132,800	993,344	584,188
20	Multiple	VITTORIA SQUARE	3300 VITTORIA WAY	607,376	759,968	167,100	1,249,908	872,417
21	004467-000	NEWBERG S.D. / EDWARDS ELEMENTARY	715 E 8TH ST	1,293,292	479,468	101,900	762,212	844,991
22	015302-000	WERTH FAMILY, LLC	TRACT A, WERTH BLVD	638,792	797,368	124,200	929,016	788,392
23	014252-000	OAK MEADOWS @ NEWBERG	DETENTION POND @ OAK MEADOWS	698,632	769,692	82,300	615,604	694,643
24	011226-001	THE GREENS @ FERNWOOD RD, NW CORNER @ WTR FOUNTAIN	GREENS AVE	708,356	667,216	88,600	662,728	679,433
25	004935-000	CANYON RIDGE APT	401 S EVEREST RD	790,636	444,312	101,500	759,220	664,723
26	004948-000	PARR LUMBER	200 N ELLIOTT RD	590,172	583,440	104,200	779,416	651,009
27	010431-002	NO OWNER ON RECORD	NO ADDRESS ON RECORD	297,704	575,212	117,500	878,900	583,939
28	014761-002	NO OWNER ON RECORD	NO ADDRESS ON RECORD	392,700	742,764	76,200	569,976	568,480
29	001745-000	SPRINGBROOK APARTMENTS	1401 SPRINGBROOK RD	579,700	563,992	61,000	456,280	533,324
30	003896-002	CHEHALEM PARK AND REC / REC CENTER	502 E 2ND ST	256,564	430,848	111,700	835,516	507,643
31	015301-001	WERTH FAMILY, LLC	TRACT C, PROVIDENCE DR	488,444	386,716	67,000	501,160	458,773
32	001753-000	A-DEC	2601 CRESTVIEW DR - BLDG	296,208	491,436	75,600	565,488	451,044
Total Annual Consumption(gallons):				84,970,077	89,976,531	11,907,658	89,069,282	98,865,297
Total Annual Consumption(mgd):				0.76	0.80	0.11	0.80	0.88

Springbrook Development

Potential non-potable demand projections include the proposed Springbrook Development, to be sited within the north end of the city limits. The new development will be approximately 50 acres in size. Current plans for development provide for multiple community parks and individual residential lawns. Based upon discussions with the City, it has been estimated 50% of the development will require consistent irrigation.

To estimate irrigation demands within the Springbrook Development, the City's historical irrigation season of approximately 16 weeks is used. Using historical weekly watering data for the Newberg area as obtained from the Regional Water Providers Consortium, an average application rate of approximately 1 inch per week will be required to sufficiently irrigate turf and ornamental plants during this season. Maintaining an application rate of 1 inch per week for a full 16-week irrigation season will be equivalent to applying 1.33 feet of water over the planned irrigated areas.

Total irrigation water demands for the development may be calculated as follows:

$$\begin{aligned}\text{Annual volume of water} &= 50\% (50 \text{ acres} \times 43,560 \text{ SF/acre}) \times 16''/12 \text{ of water applied} \\ &= 50\% (2,178,000 \text{ SF}) \times 1.33 \text{ feet of water applied} \\ &= 1.45 \text{ million cubic feet } (\sim 11 \text{ MG})\end{aligned}$$

Averaged over the irrigation season, this equates to a daily demand of nearly 0.1 mgd.

Summary

This section presents existing and projected future non-potable water demands for the City's service area. Demand forecasts are developed from review of historic water use records, as well as from discussions with City staff, to determine likely future non-potable water customers. The focus of determining future demands is to estimate the potential to supply non-potable water for irrigation of residential, industrial and commercial customers.

SECTION B4 NON-POTABLE WATER DISTRIBUTION SYSTEM

This section presents alternatives for an expanded non-potable water distribution system within the City of Newberg's (City's) service area.

Existing Non-Potable Water Distribution System

The sole customer for the City's non-potable water is the Chehalem Glenn Golf Course, owned and operated by the Chehalem Park & Recreation District (CPRD). The golf course receives non-potable water from both Otis Springs and the City's waste water treatment plant (WWTP). Otis Springs water is delivered to the north end of the golf course through approximately 4,750 linear feet (LF) of 8-inch diameter pipe. Recycled water from the WWTP is routed to the southern end of the golf course through approximately 7,500 LF of City-owned 10-inch diameter pipe and 1,500 LF of privately-owned CPRD 8-inch diameter main.

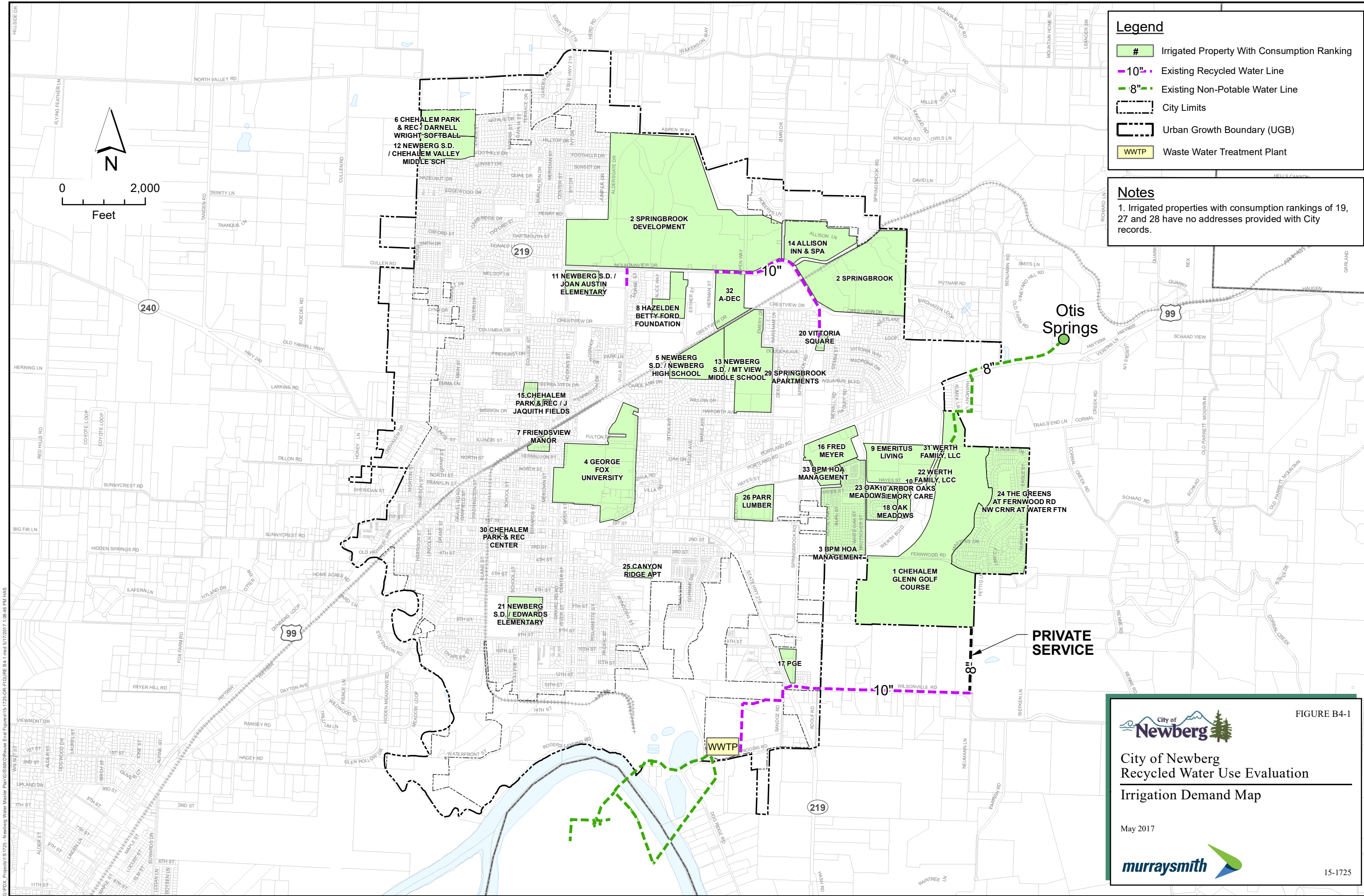
The City has also constructed numerous sections of America Water Works Association (AWWA) C900 PVC pressure pipe, colored purple to denote non-potable water use, within the northern end of the city. These sections of purple pipe have been installed over the course of several years as part of other utility improvement work completed by the City. The intention in constructing this piping has been to integrate it into a larger non-potable water distribution network in the future.

Expansion of Non-Potable Water Distribution System

The City is interested in opportunities to connect existing metered irrigation customers supplied with potable water to an expanded non-potable water system.

The locations for the City's top irrigators, including the proposed Springbrook Development, and existing non-potable water infrastructure are shown in **Figure B4-1**. Each of these properties, apart from the Chehalem Glenn Golf Course, receive irrigation water from connections to the City's potable water distribution system. Most of the properties are in the east and north sections of the city, in relatively close proximity to the City's existing non-potable water distribution system infrastructure. Expansion of the existing non-potable water distribution system should look to maximize development near existing infrastructure.

It should be noted, following any potential expansion of the City's non-potable water distribution system, there is no requirement in the City's development code for property owners to connect to this system. Since non-potable water cannot be mixed with potable water, connecting existing metered irrigation customers to an expanded non-potable water system would require improvements between meters and new and existing distribution mains. Construction costs estimated in this Section include only work associated with main line improvements and do not include improvements at meters or from new main to customer meters.

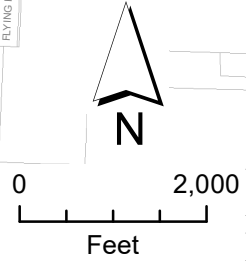


Legend

- # Irrigated Property With Consumption Ranking
- 10" Existing Recycled Water Line
- 8" Existing Non-Potable Water Line
- City Limits
- Urban Growth Boundary (UGB)
- WWTP Waste Water Treatment Plant


Notes

1. Irrigated properties with consumption rankings of 19, 27 and 28 have no addresses provided with City records.




G:\PDX_Proj\15-1725 - Newberg Water Master Plan\GIS\MapDocs\Reuse Eval\Figure B4-1.mxd, 5/17/2017, 1:08:46 PM, HAS

FIGURE B4-1


 City of Newberg
 Recycled Water Use Evaluation
 Irrigation Demand Map

May 2017



15-1725

Expansion Options

An evaluation was completed for the proposed expansion of the City's non-potable water distribution system. Four options for the expansion of the system were investigated. A preferred final option is provided that minimizes construction complexities, installation costs, and future operation and maintenance costs.

Option A: Do Nothing

Under this option, the City would continue to serve the Chehalem Glenn Golf Course using recycled water generated at the WWTP in combination with non-potable water from Otis Springs. No new infrastructure would be constructed, and existing capacity for recycled water production at the WWTP would not be improved. Future users near the existing non-potable water piping and supply sources may be connected to the system over time based upon their interests and willingness to pay for improvements.

There are no additional capital costs incurred by the City under this option.

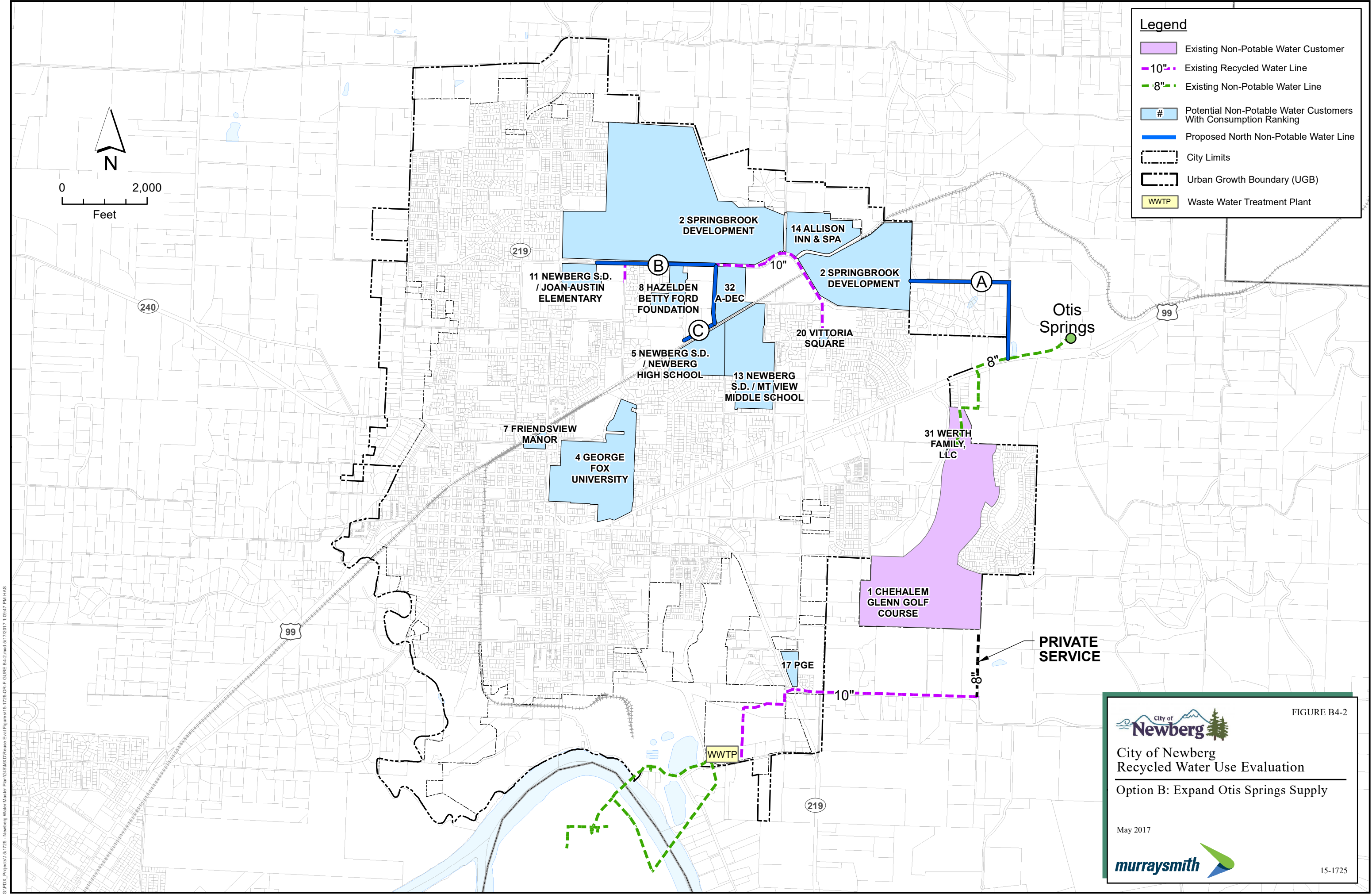
Option B: Expand Supply from Otis Springs

This option includes installation of additional piping from the Otis Springs supply line to serve existing and new development on the north end of the City, as shown in **Figure B4-2**. Average annual consumption for these properties totals approximately 22.5 million gallons (MG) or 0.2 million gallons per day (mgd). Recycled water from the WWTP would be the sole source to supply irrigation water to the Chehalem Glenn Golf Course.

Construction of the non-potable piping improvements could be completed in segments, labeled as A through C in **Figure B4-2**. Proposed piping improvements are shown within existing public right-of-way. Construction of Segment A would allow for Otis Springs supply to the proposed Springbrook Development. It is understood from discussions with City staff that conditions for development of this community would require the installation of non-potable water distribution piping to serve its various parks and residential lawns. Once the piping is installed through Springbrook Development, it may be connected to purple pipe previously installed by the City in the immediate area. Construction of Segments B and C may occur at later dates, as may be desired.

Pumping improvements at Otis Springs are recommended to replace and upgrade aged infrastructure and allow for a constant pressure pumping configuration. As the anticipated demand is well under the springs' production capacity of 0.5 mgd, there appears to be no need to construct storage onsite.


Estimated costs associated with expanding supply from Otis Springs are provided in **Table B4-2**. Full build out of this option is estimated to cost approximately \$3.6 million.




Legend

- Existing Non-Potable Water Customer
- 10" Existing Recycled Water Line
- 8" Existing Non-Potable Water Line
- # Potential Non-Potable Water Customers With Consumption Ranking
- Proposed North Non-Potable Water Line
- City Limits
- Urban Growth Boundary (UGB)
- WWTP Waste Water Treatment Plant

FIGURE B4-2


 City of Newberg
 Recycled Water Use Evaluation
 Option B: Expand Otis Springs Supply

May 2017



15-1725

G:\PDX_Projects\15-1725 - Newberg Water Master Plan\GIS\Map\Reuse Eval\Figure B4-2.mxd, 5/17/2017 1:08:47 PM HAS

**Table B4-2
Costs for Expansion Option B**

Improvements	Segment A	Segment B	Segment C	Totals
Piping ¹	\$1,350,000 (approx. 4,500 LF)	\$1,050,000 (approx. 3,500 LF)	\$750,000 (approx. 2,500 LF)	\$3,150,000
Pumping	\$400,000	--	--	\$400,000
Storage	--	--	--	--
Subtotal	\$1,750,000	\$1,050,000	\$750,000	\$3,550,000

Notes:

1: Cost estimates assume installation of 8-inch diameter AWWA C900 DR18 purple PVC piping, including appurtenances, trench backfill and surface restoration, at \$300/LF.

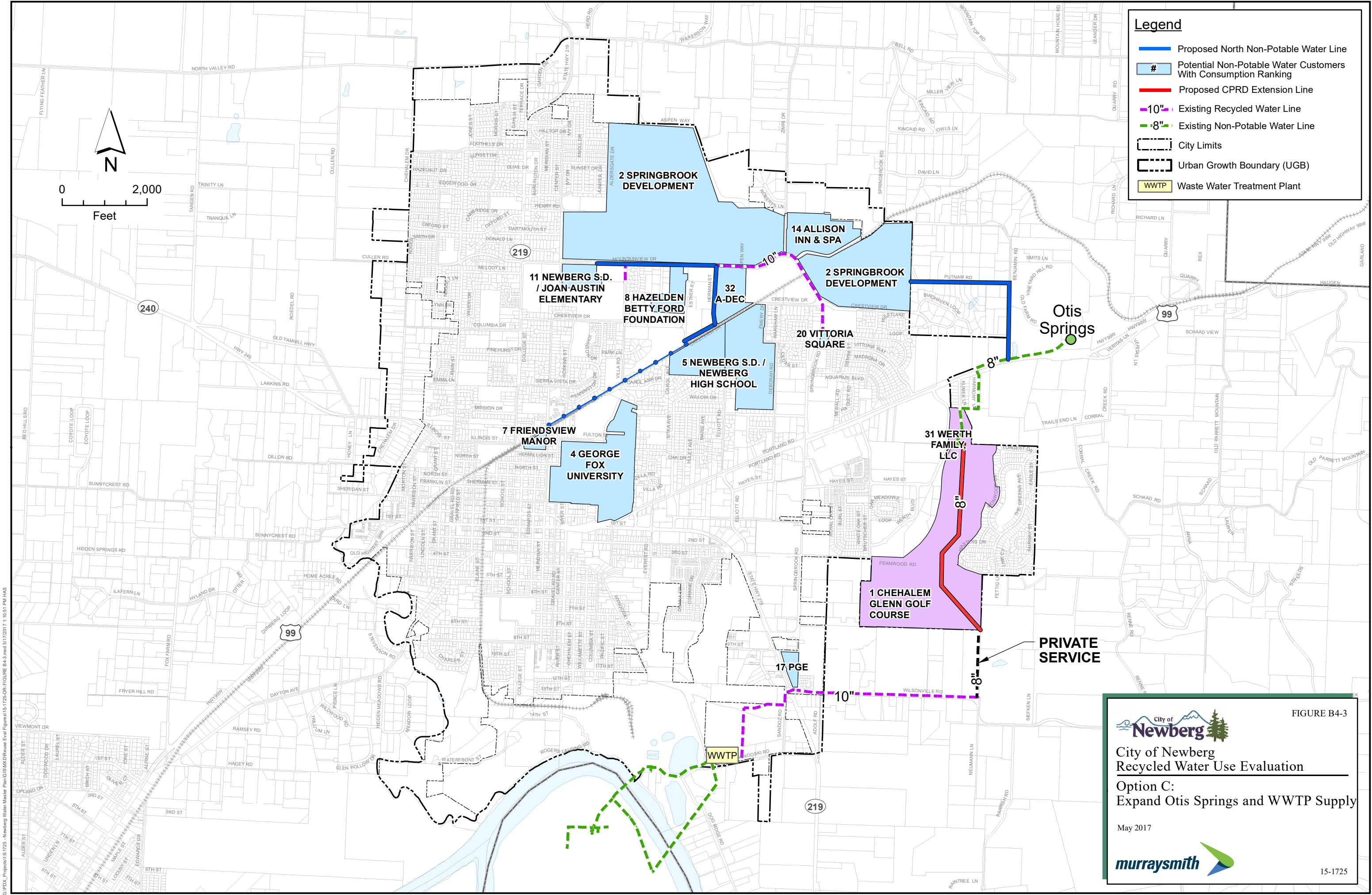
Option C: Expand Supply from Otis Springs and WWTP

This option includes installation of piping from the Otis Springs supply line to serve existing and new development on the north end of the City, as discussed with non-potable water expansion Option B. This option also includes extending CPRD’s existing private line to the Chehalem Glenn Golf Course to connect with the existing Otis Springs supply at the north end of the golf course. Piping improvements proposed with this option are shown in **Figure B4-3**. Average annual consumption for these properties, including the golf course, totals approximately 78 MG (0.7 mgd). Recycled water from the WWTP would be used in combination with Otis Springs to meet non-potable water irrigation demands for both the Chehalem Glenn Golf Course and existing residential, industrial and commercial customers.

The proposed North Non-Potable Water Line could be constructed in segments, as discussed in detail for Option B. Additional piping to reach potential customers at the far west terminus of the line may require an agreement to place the line within railroad property or a re-routing of the alignment from that currently shown. Additional non-potable water irrigation customers could be added to the system following an extension of the CPRD line through the golf course.

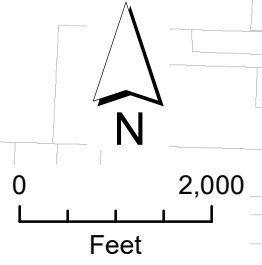
Pumping improvements at Otis Springs are recommended to replace and upgrade aged infrastructure and allow for a constant pressure pumping configuration. Additionally, at such a time as CPRD line is extended through the golf course, modifications to existing recycled water effluent pumps may be considered. As the anticipated demand for the system is well under the combined WWTP and springs’ production capacity of 1.5 mgd, there appears to be no need to construct storage at either location.

Estimated costs associated with expanding supply from Otis Springs and the CPRD supply line are provided in **Table B4-3**. Full build out of this option is estimated to cost approximately \$6.7 million. Estimates do not incorporate costs to connect existing irrigation customers to the non-potable water main improvements. Extensive service piping to individual meters may be required to serve potential customers adjacent to the golf course.



Legend

- Proposed North Non-Potable Water Line
- # Potential Non-Potable Water Customers With Consumption Ranking
- Proposed CPRD Extension Line
- 10" Existing Recycled Water Line
- 8" Existing Non-Potable Water Line
- City Limits
- Urban Growth Boundary (UGB)
- WWTTP Waste Water Treatment Plant



G:\PDX_Projects\15-1725 - Newberg Water Main Plan\GIS\Map\Output\Map\15-1725-OR-FIGURE B4-3.mxd, 5/17/2017 1:10:51 PM HAS

FIGURE B4-3

City of Newberg
 Recycled Water Use Evaluation
 Option C:
 Expand Otis Springs and WWTTP Supply
 May 2017

15-1725

**Table B4-3
Costs for Expansion Option C**

Improvements	North Line (Segments A - C)	North Line Extension	CPRD Line Extension	Totals
Piping ¹	\$3,150,000	\$1,200,000 (approx. 4,000 LF)	\$1,500,000 (approx. 5,000 LF)	\$5,850,000
Pumping	\$400,000	--	\$400,000	\$800,000
Storage	--	--	--	--
Subtotal	\$3,550,000	\$1,200,000	\$1,900,000	\$6,650,000

Notes:

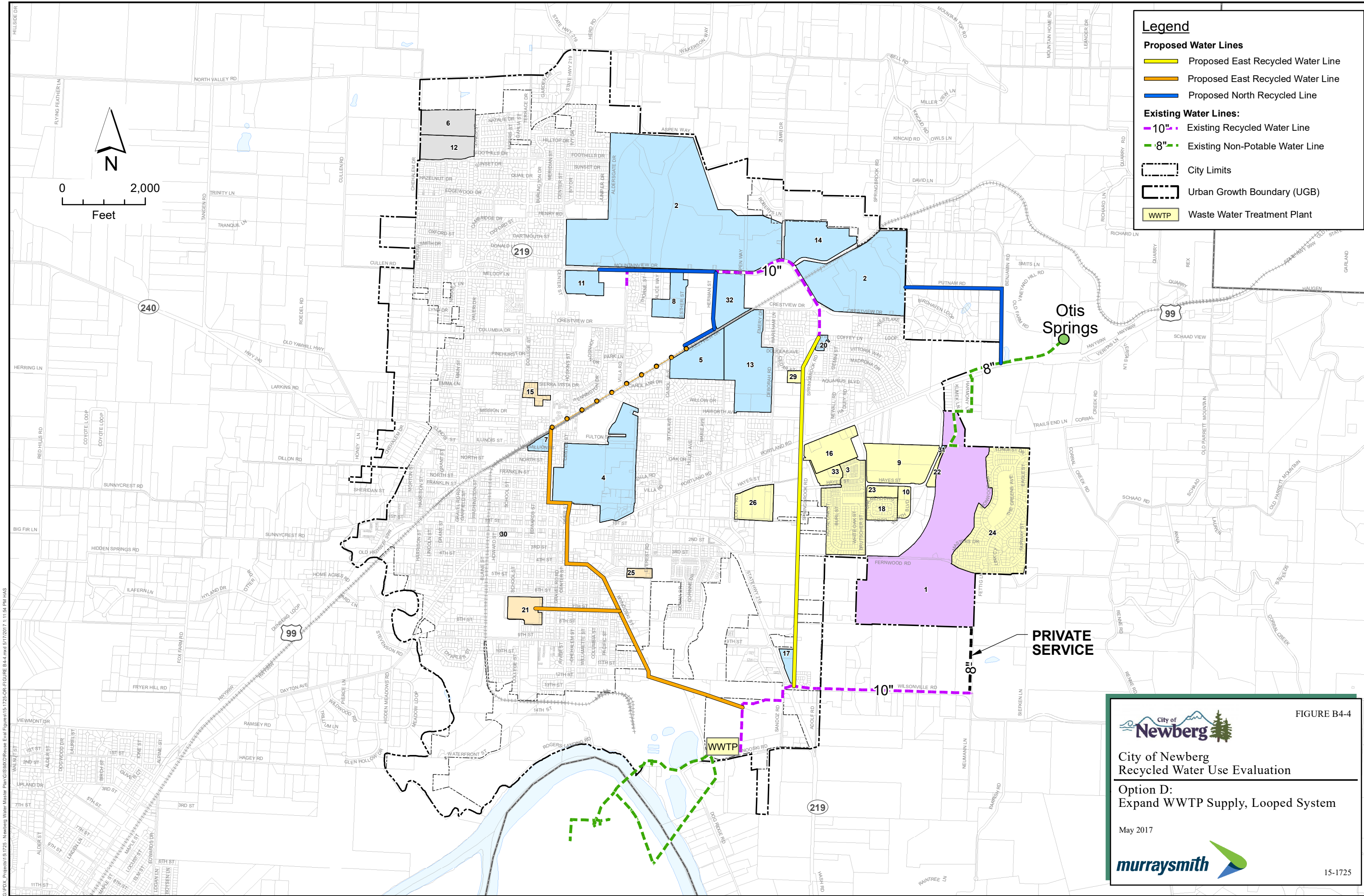
1: Cost estimates assume installation of 8-inch diameter AWWA C900 DR18 purple PVC piping, including appurtenances, trench backfill and surface restoration, at \$300/LF.

Option D: Expand WWTP Supply, Looped System

This option for expansion of the City’s non-potable water system includes development of a looped distribution network to, eventually, service all the City’s top irrigators, as shown in **Figure B4-4**. Average annual consumption of this distribution network, excluding the golf course, totals approximately 50 MG (0.45 mgd); with the golf course included, average annual consumption for the build-out non-potable water distribution system is approximately 92 MG (0.8 mgd). Under this option, Otis Springs would only provide service to the golf course.

Construction of the non-potable piping improvements will be completed in segments. Proposed piping improvements are shown within existing public right-of-way, except the western portion of the North (Blue) Recycled Water Line. In the current alignment shown for the North Recycled Water Line, an agreement to place the line within railroad property or a re-routing of the alignment will be required. The largest annual irrigation demands are found along the proposed North Recycled Water Line at approximately 23 MG (0.2 mgd). To supply the North Recycled Water Line, though, either the proposed West or East Recycled Water Line would first need to be constructed. The East (Yellow) Recycled Water Line has average annual irrigation demands of approximately 18 MG (0.15 mgd), almost twice the volume of the West (Orange) Recycled Water Line’s demands of approximately 9.5 MG (0.1 mgd). Additionally, constructing the East Recycled Water Line to supply the North Recycled Water Line distributes the greatest amount of non-potable water to customers at the lowest costs and delays the need for finding a means to connect the West Recycled Water Line to the North Recycled Water Line.

Demands for the build-out of this scenario, with or without the inclusion of supply to the golf course, do not surpass the existing 1.0 mgd capacity of the WWTP’s recycled water production facility. Upgrades to the WWTP’s recycled water production capacity, then, are not readily required under this option. However, existing recycled water effluent pumps would likely need to be reconfigured or replaced to serve the larger distribution system. If the City desires to provide a reliable source for non-potable water to irrigators under this option, it is recommended two days’ worth of storage for the system be provided at approximately



Legend

Proposed Water Lines

- Proposed East Recycled Water Line (Yellow)
- Proposed East Recycled Water Line (Orange)
- Proposed North Recycled Line (Blue)

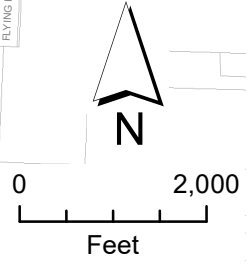
Existing Water Lines:

- 10" Existing Recycled Water Line (Purple)
- 8" Existing Non-Potable Water Line (Green)

City Limits (Dashed line)

Urban Growth Boundary (UGB) (Solid line)

WWTP Waste Water Treatment Plant (Yellow box)



PRIVATE SERVICE

Otis Springs

City of Newberg

City of Newberg
 Recycled Water Use Evaluation

Option D:
 Expand WWTP Supply, Looped System

May 2017

murraysmith

FIGURE B4-4

15-1725

G:\PDX_Proj\15-1725 - Newberg Water Master Plan\GIS\MapDocs\Reuse Eval\Figure B4-4.mxd, 5/17/2017, 11:54 AM, HAS

1.6 MG. Capital costs associated with pumping and storage improvements may be phased with construction of new non-potable water distribution piping.

Estimated costs associated with expanding non-potable water supply from the WWTP are provided in **Table B4-4**. Full build out of this option is estimated to cost approximately \$11.7 million.

Table B4-4
Costs for Expansion Option D

Improvements	East (Yellow) Line	North (Blue) Line	West (Orange) Line	Totals
Piping ¹	\$2,550,000 (approx. 8,500 LF)	\$1,800,000 (approx. 6,000 LF)	\$4,500,000 (approx. 15,000 LF)	\$8,850,000
Pumping	\$400,000	\$400,000	--	\$800,000
Storage	\$1,000,000	\$1,000,000	--	\$2,000,000
Subtotal	\$3,950,000	\$3,200,000	\$4,500,000	\$11,650,000

Notes:

1: Cost estimates assume installation of 8-inch diameter AWWA C900 DR18 purple PVC piping, including appurtenances, trench backfill and surface restoration, at \$300/LF.

2: Storage estimates assume a ground-level welded steel tank.

Preferred Expansion Option

Based on the evaluation of four options for expansion of the City’s non-potable water distribution system, it appears Option B provides the City with minimal construction complexities, installation costs, and future operation and maintenance costs in comparison to other alternatives. Option B also allows the City to reconsider Option D or other expansions of the system if future opportunities for non-potable water use arise.

Summary

This section of the report presented alternatives for an expanded non-potable water distribution system within the City’s service area. A preferred expansion option for the City’s non-potable water distribution system was selected.





Water Solutions, Inc.

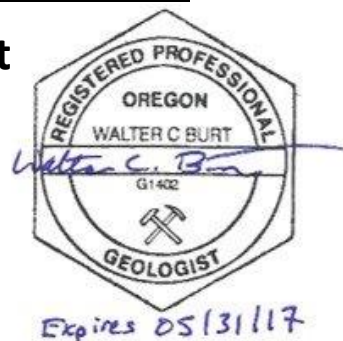
TECHNICAL MEMORANDUM

City of Newberg Supply Source Expansion Assessment

PREPARED FOR: Heidi Springer, PE – Murraysmith
Brian Ginter, PE – Murraysmith

PREPARED BY: Walt Burt, RG – GSI Water Solutions, Inc.
DeEtta Fosbury, RG – GSI Water Solutions, Inc.

DATE: January 9, 2017



Introduction

This technical memorandum (TM) summarizes GSI Water Solutions, Inc.'s (GSI) assessment of alternatives for future expansion of the City of Newberg's (City) supply source capacity. This assessment was prepared under subcontract to Murraysmith as an element of the City's 2016 water system master plan update.

The purpose of this assessment is to identify and initially evaluate potential future long-term source capacity expansion alternatives. The City's sole source of supply is its Marion County wellfield, which is located on the south side of the Willamette River, across from the City's water treatment plant (WTP) and service area. The City relies on two pipelines to convey water from the wellfield: one is suspended on an aging and now unused road bridge, and one crosses under the river. The City's highest priority objective for future source expansion is to improve its supply resiliency by developing 2 million gallons per day (mgd) of redundant capacity, ideally located on the north side (City-side) of the river. The City's preference is that at least some source capacity could be located in the northern portion of the City's service area.

This assessment focuses on the evaluation of groundwater source alternatives, although a summary of initial water rights considerations related to the feasibility of developing a surface water source of supply from the Willamette River also is included.

Background

The City has evaluated a variety of locations and technologies for supplying additional groundwater supply capacity, including evaluating the feasibility of (1) constructing a horizontal collector well (Ranney, 1993; CH2M Hill, 2000), (2) using ASR as a water management tool (CH2M Hill, 2000), and (3) expanding groundwater capacity within (Sweet, Edwards & Associates, Inc., 1983, CH2M Hill, 1992) and in the vicinity of the existing well field location (Ranney, 1980; CH2M Hill, 1997; 2000; GSI, 2006). Significant findings of these studies are summarized as follows:

- The general focus of these studies was the coarse-grained, recent alluvial sediments bordering the south and north sides of the Willamette River, although one study did evaluate the potential to develop a groundwater source within the Chehalem Valley (CH2M Hill, 1997). The study concluded that the potential for developing a groundwater source in the valley that met certain minimum capacity criteria was low.
- Locations identified as having a higher possibility for developing additional supply capacity on the basis of the potential presence of productive alluvial aquifer materials included:
 - the existing Marion County well field,
 - Ash Island,
 - areas north and east of Dundee on the north side of the river,
 - the floodplain areas adjacent to the north side of the Highway 219 bridge (Gearns Ferry),
 - Willamette Greenway State Park, located several miles east of the City.

While the alluvial aquifer is hydraulically connected to the river, the connection in the vicinity of the existing well field is limited, as evidenced by microscopic-particulate analysis (MPA) testing demonstrating that groundwater produced by the City's wells located near the river is not under the direct influence of surface water, and by high iron and manganese concentrations present in raw groundwater produced by the City's wells even after extended pumping durations. The implication of this finding is that a collector well is not a preferred alternative for capacity expansion within the City's well field.

2016 Source Expansion Evaluation

This evaluation expands on the findings of the prior studies to address the City's stated goal of 2 mgd of additional source capacity with preference for locating the capacity on the north side of the river. This evaluation considers to varying degrees three general alternatives for expanding the City's supply capacity:

1. Additional groundwater supply capacity
2. Surface water supply from the Willamette River
3. Storage using aquifer storage and recovery (ASR)

The primary factors that determine which potential groundwater source expansion and storage alternatives may be feasible include aquifer yield and water rights permitting. The feasibility of developing a surface water source involves several factors, the chief of which is the availability of water rights. This evaluation provides an initial assessment of considerations regarding water rights for a surface water source on the Willamette River, and evaluation of other factors related to a surface water source are beyond the scope of this evaluation.

While prior studies have focused primarily on the shallow alluvial aquifer, the City's source expansion priorities dictate expanding the focus of this evaluation to include consideration of other aquifers on the north side of the river. The assessment of developing additional groundwater source capacity involved two general steps: (1) identifying where the hydrogeology may be favorable for groundwater supply and/or ASR system development and where a water right can be obtained for a 2 mgd source of supply, and (2) developing potentially feasible alternatives, evaluating each relative to relevant criteria to identify benefits, risks and key uncertainties.

The remainder of this report includes the following elements:

- Description of the hydrogeology of the Newberg area to provide the basis for evaluation of the groundwater source alternatives
- Evaluation of feasibility of obtaining water rights for groundwater and Willamette River surface water sources
- Identification and evaluation of alternatives
- Summary of results

Hydrogeologic Setting

This section summarizes key aspects of the hydrogeology of the Newberg area, including the Chehalem Valley and bordering uplands (Chehalem Mountain and Parrett Mountain) to provide background and context for identifying favorable conditions for developing a 2 mgd supply and/or ASR system. The City of Newberg is bounded by the Red Hills of Dundee to the west and Parrett Mountain to the east. The Willamette River bounds the City to the south, and Chehalem Mountain is located just north of the City. The Newberg area is underlain by four major geologic units, which include (from oldest to youngest): Eocene to Miocene-age marine sediments, middle to late Miocene-age basalt flows of the Columbia River Basalt Group (CRBG), late Tertiary to early Quaternary semi-consolidated to unconsolidated (basin-fill) sediments, and Quaternary alluvial sediments near the river. The general characteristics of these units that are relevant to the potential to develop a groundwater supply source are summarized below. Figure 1 shows the general distribution of these units and mapped structures in the study area.

Marine Sediments

Marine sediments, consisting of tuffaceous and basaltic sandstone, siltstone, shale, and claystone, are exposed north and west of the City. Wells completed in this unit typically yield less than 10 gallons per minute (gpm), although locally some wells completed in fractured shale or sandstone may produce up to 200 gpm (Frank and Collins, 1978). The groundwater from this unit is generally of poor quality, containing elevated levels of total dissolved solids (TDS). This unit is not considered further as a target for source development because of poor quality water and low well yields.

CRBG

CRBG aquifers are an important source of municipal and agricultural groundwater supply in the Willamette Valley, and host several municipal ASR systems in the Tualatin Basin and City of Salem. Consequently, this evaluation took a close look at the potential feasibility of developing a groundwater source of supply or ASR system in the CRBG.

The CRBG consists of a series of laterally extensive tabular sheet basalt lava flows that originated from eruptive fissures in western Idaho and eastern Oregon and Washington, covering large areas of the Columbia River Plateau, Columbia Gorge and Willamette Valley. CRBG basalt flows typically exhibit a three-part intraflow structure: flow top, flow interior and flow bottom. The flow top and flow bottom are commonly vesicular and brecciated, which together may form relatively permeable zones that comprise the primary aquifers in the CRBG.

The CRBG in northwest Oregon consists of several individual lava flows; eleven separate flows were identified in the Parrett Mountain area by Miller et. al. (1994). The individual basalt flows range from a few feet to a few hundred feet thick, and are on average approximately 100 feet thick. The CRBG is estimated to be approximately 1,000 feet thick in the vicinity of Chehalem Mountains and Parrett Mountain. The Dundee Hills, located southwest of Newberg, also are comprised of CRBG flows, although

the section is significantly thinner than that of Chehalem and Parrett Mountains. The presence and nature of the CRBG underneath the City has not been documented.

The Chehalem Valley and south side of Chehalem Mountain define the Gales Creek/Mt Angel fault zone, a regional northwest-trending fault zone, which displaces older marine sediments against CRBG in the Chehalem Valley. Where larger faults offset water-bearing interflow zones in the CRBG, the aquifers are commonly bounded or compartmentalized. Compartmentalization limits the amount of water that can be stored in an aquifer and magnifies drawdowns in production wells. These effects limit the productivity and longer-term sustainable capacity of wells. The CRBG may be absent under portions of the City as a result of displacement by the fault. Surrounding basalt highlands are segmented by parallel northwest-trending and cross-cutting faults (Miller, et al, 1994; and Frank and Collins, 1978). As a consequence, CRBG aquifers are expected to be highly-compartmentalized, particularly under Parrett Mountain and the Dundee Hills. Declining water levels and boundary effects identified during aquifer testing in these areas are consistent with a compartmentalized aquifer system.

A review of water well logs for the general vicinity of the City indicates that well yields for the CRBG range between 5 and 450 gpm, but are generally less than 150 gpm for domestic or community supply wells. Further, the basalt aquifers in the highlands around Newberg have experienced declining water levels in response to pumping. A study completed by Miller et. al. (1994) found that groundwater levels in the CRBG in the Parrett Mountain area had declined on average 1 foot per year over the previous 14 years. The water level declines have prompted the Oregon Water Resources Department (OWRD) to designate the CRBG aquifers under Chehalem Mountain and Parrett Mountain as Groundwater Limited Areas (GWLAs; Figure 1). Limited well yields and groundwater level declines in these areas are consistent with compartmentalization of the CRBG aquifers, which has unfavorable implications both for developing a sustainable source and for implementing ASR in the CRBG.

The few basalt wells within the City limits are located mostly in the northern portion of the City, and generally yield less than 80 gpm. United States Geological Survey (USGS) regional-scale mapping suggests the possible presence of a relatively thick section of CRBG beneath the older basin-fill sediments near the Willamette River; however, the presence of basalt under the southern portion of the City is unverified, and older mapping interprets that the basalt section has been removed by faulting and erosion under a portion of the City. Additional investigation, including drilling exploratory borings near the periphery of the south and west edges of the City limits would be necessary to confirm the presence of the CRBG and to assess the viability of the CRBG aquifer(s) in this area.

In summary, well yields and the nature and distribution of the CRBG, where known to be present outside the GWLAs, suggest that the potential for drilling a supply well with a high capacity (>500 gpm) within the CRBG is low. The potential for developing a groundwater source in the CRBG in areas that have not been explored (and the CRBG potentially is absent) is highly uncertain.

Basin-Fill Sediments

This geologic unit consists of alluvial sediments deposited in the Chehalem Valley and south into the Willamette Valley, and includes the Willamette Silt and the Lower Sedimentary Unit (LSU) of Conlon, et al (2015). Within the Willamette and Chehalem valleys, this unit consists of fine-grained sediments and is typically described on well logs as blue clay with minor amounts of sand and gravel present (Conlon et. al., 2015). In the vicinity of the City, the LSU is primarily silt and clay, with occasional beds of fine sand and some gravel. The thickness of this unit varies from a few feet up to approximately 480 feet (Frank and Collins, 1978). The LSU overlies the CRBG, and where the CRBG is not present, the LSU overlies the Marine Sediments. The Willamette Silt overlies the LSU, and is generally less than 50 feet thick. Wells

completed in the basin-fill sediments typically have production rates of less than 200 gpm. On the basis of low existing well yields, the potential for developing a high yield production well within the basin-fill sediments is low.

Younger Alluvium

This unit consists of younger alluvial sediments deposited within the floodplain of the Willamette River. In the general vicinity of the City, the lower portion of this unit commonly consists of channel-derived sand and gravel, which is interlayered with and overlain by backwater/overbank-derived silt and clay. The coarser section of the unit comprises the alluvial aquifer, the most productive aquifer in the Newberg area, and is the City's source of supply for its Marion County wellfield.

The Willamette River is entrenched into older sediments in the Newberg area. The implication of this environment is that the floodplain areas where younger alluvial sediments are present are limited in extent on the outside (north) of the bend in the river as it flows past Newberg. Areas where the alluvial aquifer is confirmed or more likely to be present include: (1) within the broad floodplain that defines the inside of the riverbend on the south side of the river, and (2) in two areas on the north side of the river: including between the City and Dundee, and the area adjacent to the Highway 219 bridge, southeast of the City (Figure 1).

In most areas, the coarser-grained sediments forming the alluvial aquifer are 10 to 30 feet thick, although several investigations focused on the area surrounding the City's production wells have identified a paleochannel with up to 95 feet of coarser-grained sediments (CH2M Hill, 2000). The City's wellfield is located within and around this paleochannel (Figure 2). A thicker sequence of coarse-grained sediments also has been observed in two irrigation wells located within the area east of Highway 219 on the north side of the river. Wells completed in the alluvial aquifer typically produce water with high concentrations of iron and manganese.

Summary

Wells completed in the Marine Sediments are likely to produce low quantities of poor-quality water. Likewise, the LSU is not a productive aquifer in this area. The CRBG aquifers outside and in the northern part of the City, where known to be present, are compartmentalized, have low to medium yields, and declining water level trends. The presence, thickness, and productivity of the CRBG in the southern portion of the City is unknown. Wells completed in younger alluvium present under the Willamette River floodplain and in hydraulic connection with the river are known to produce 1,000 to 3,000 gpm, depending on seasonal variations in water levels, well construction, and the thickness and nature of the alluvium in which the well is completed. Consequently, the highest-potential alternative for developing a 2 mgd groundwater source on the north side of the river is to target the coarse material found in the younger alluvium near the Willamette River.

Water Rights Considerations

Surface Water Rights

At the request of the City, we completed a preliminary evaluation of the feasibility of obtaining a water right to develop a Willamette River surface water supply source, including obtaining a new water right and acquiring an existing right. This evaluation did not include consideration of other feasibility factors for development of a surface water source.

Obtaining a New Surface Water Permit

The following discussion evaluates the City of Newberg's ability to obtain a new surface water right authorizing the use of up to 2 mgd of surface water from the Willamette River for municipal purposes. Prior to issuing a permit, OWRD will review a surface water application to determine whether:

- 1) Water is available for the proposed use;
- 2) The proposed use is allowed in the applicable basin program administrative rules;
- 3) The use would not cause injury to other water rights; and
- 4) The use is consistent with other rules of the Water Resources Commission.

If OWRD finds that each of the criteria is met, the agency can presume that the proposed use would be in the public interest and issue a water use permit. (It is worth noting that third parties can challenge this determination as part of the permit application process.)

Based on our review of each of these criteria, as described below, GSI anticipates that OWRD would find that the proposed use of water from the Willamette River would be in the public interest, and could issue a permit for that use. As discussed below, the permit would, however, be expected to have conditions that could limit the use of water during periods of low flow.

Water Availability: To determine water availability for new surface water permits, OWRD considers its water availability analysis at 80 percent exceedance, which indicates whether the requested water would be expected to be available 8 years out of 10. Water is available in the Willamette River above the Molalla River at 80 percent exceedance each month of the year. Therefore, OWRD would find water to be available for the proposed use.

Basin Program Administrative Rules: OWRD's Willamette River basin program administrative rules identify the "classified" (allowable) uses of the water in the basin's waterways. The classified uses of water from the mainstem Willamette River below the Calapooia River (near Albany) include the use of water for municipal purposes. As a result, OWRD would find the proposed use of surface to be consistent with the Basin Program.

Injury: A new permit issued for the proposed use would be "junior in priority" to all existing water rights. Under the prior appropriation system, if insufficient water was available to meet the needs of all water users, the most junior would be regulated off until the needs of the senior water right holders were met. Based on this system, OWRD would conclude that issuance of a new permit would not cause injury to existing water rights.

Other Rules of the Commission: As part of this final assessment, OWRD will consider whether the proposed use of water is consistent with its "Division 33 rules," which are used to determine whether the use will impair or be detrimental to the public interest with regard to fish species listed under the state or federal endangered species acts. As part of this process, OWRD will request input from the Oregon Department of Fish and Wildlife (ODFW) and the Oregon Department of Environmental Quality (DEQ) about impacts of the proposed water use on listed fish and fish habitat. Based on our experience with other Willamette River permit applications, we would anticipate ODFW (and potentially DEQ) to raise some concerns about the proposed use of water and to recommend approval of the application with conditions. The most significant condition we would expect the agencies to recommend would be a condition to protect certain levels of streamflow in the Willamette River. (These target flows were identified as part of the Willamette Basin Project Biological Opinion.) The condition would only allow the diversion of water if the stream gage at Salem showed that the following target flows were met:

Time Period	Streamflow in cubic feet per second
October	5,630
November through March	6,000
April 1 to April 15	15,000
April 16 to April 30	17,000
May	15,000
June 1 to June 15	12,600
June 16 to June 30	8,500
July through September	5,630

The streamflows in the Willamette River are controlled primarily by the U.S. Army Corps of Engineers (USACE) releases of water from the Willamette Basin Project federal reservoirs. The USACE typically operates the reservoirs in a manner that causes these target flows to be met. During deficit water years, however, these target flows may not be met. In such cases, the condition recommended by ODFW would preclude the diversion of water under a new permit. In 2015, the flow targets were not met for a total of 142 days.

GSI anticipates that OWRD would issue the City a permit for the proposed use of surface water from the Willamette River. The City may, however, be unable to obtain water under the permit during periods of low flow due to conditions that are expected to be included in the permit. These conditions are being applied to new permits in order to maintain adequate stream flows during summer months. Use can be curtailed during times when the Willamette River does not meet target stream flows (as determined by the Oregon Department of Fish and Wildlife and the Oregon Department of Environmental Quality). For example, target flows were not met during the summer of 2015 for a total of 142 days.

The City should also be aware that in the Willamette Basin Program administrative rules, there are “minimum perennial streamflows” (MPSFs) for the use of stored water. At some point in the future, the MPSFs may be changed into instream water rights that would protect water released from the federal reservoirs as it flows down the Willamette River, which could possibly affect holders of Willamette River water rights. The City may want to investigate this issue further if it is seriously considering obtaining a Willamette River water right.

Obtaining an Existing Surface Water Right

An alternative to obtaining a new surface water permit would be to purchase an existing surface water right, ideally one that does not have the same conditions to which a new permit would be attached. To be acquired, the water right would need to be perfected, as evidenced by a water right certificate, and “transferred” (changed) to allow the City to use the water for municipal purposes. OWRD would evaluate a transfer application to determine whether the requested change would cause “injury” to existing water rights (prevent them from receiving water to which they are entitled) or “enlargement” (increase the amount of water that could be used under the water right). Additionally, a transfer cannot change the source of water, so water flowing past the original point of diversion must also be able to flow past the new point of diversion. A detailed analysis of a transfer would require identification and review of a water right to be transferred. Typically transferring water downstream will not be determined to cause injury or enlargement. Also, on the Willamette River it may also be possible to transfer an existing water right to a new location upstream under certain circumstances.

Groundwater Rights

Obtaining a New Groundwater Right

No new groundwater permits will be issued for municipal supply in the CRBG in the Parrett Mountain or Chehalem Mountain GWLAs, and it is unlikely that OWRD would issue a permit for a new CRBG source in the Dundee Hills. Consequently, the areas where OWRD potentially would issue a water right for the CRBG are limited. Figure 1 shows locations outside the GWLAs where CRBG has been mapped. As mentioned earlier, the presence and nature of CRBG is unknown across a broad area within and west of the City.

For the remainder of this analysis, we have assumed that the well(s) would likely be completed in the alluvial aquifer and located within one-quarter mile of, and hydraulically connected to, the Willamette River. Prior to issuing a groundwater permit, OWRD would review a permit application according to the same four criteria described above for a new surface water permit application:

- 1) Water is available for the proposed use;
- 2) The proposed use is allowed in the applicable basin program administrative rules;
- 3) The use would not cause injury to other water rights; and
- 4) The use is consistent with other rules of the Water Resources Commission.

We have evaluated each of these review criteria to determine the expected outcome of OWRD's review of a permit application requesting the use of 2 mgd of groundwater for municipal use.

Water availability: First, OWRD will evaluate whether groundwater is available for the proposed use. In performing this evaluation, OWRD will consider the water bearing unit (or aquifer) from which groundwater will be withdrawn for the proposed use, the proposed rate of water use, and any existing information OWRD has regarding the aquifer's water level (e.g., whether the aquifer water level is stable, increasing, or declining). A declining aquifer level suggests that existing groundwater withdrawals are exceeding recharge to the aquifer, which may result in OWRD making an unfavorable finding regarding groundwater availability.

In addition, OWRD will determine if the proposed use would have the potential for substantial interference (PSI) with surface water. If OWRD found PSI with surface water, it would subject the groundwater use to regulatory limitations on the adjacent surface water source, such as surface water availability. In making this determination, OWRD will first determine whether a well is developing water from a confined or unconfined aquifer. Next, OWRD will determine whether the aquifer is hydraulically connected to surface water. In making this determination, OWRD will assume that a well less than one-quarter mile from a surface water source that produces water from an unconfined aquifer is hydraulically connected to the surface water. Finally, if the well is determined to produce water from an aquifer that is hydraulically connected to surface water, OWRD will determine whether it has the potential to cause substantial interference with surface water. OWRD will assume that a use of hydraulically-connected groundwater will have PSI if it meets any of the following criteria:

1. The well is less than one-quarter mile from the surface water;
2. The well is less than one mile from the surface water, and groundwater would be appropriated at a rate greater than five cubic feet per second (cfs) ;
3. The well is less than one mile from the surface water, and groundwater would be appropriated at a rate greater than one percent of the pertinent minimum perennial streamflow, senior instream water right, or the natural streamflow that is expected 80 percent of the time; or

4. The well is less than one mile from the surface water, and groundwater appropriation for a period of 30 days would cause stream depletion greater than 25 percent of the rate of appropriation.

For a permit application to use groundwater from the alluvial aquifer, we anticipate that OWRD would find that groundwater is available. Because the alluvial aquifer is expected to have hydraulic connection with surface water, OWRD will next determine if the proposed use of groundwater would have PSI with the surface waters. Since the new well is expected to be located within one-quarter mile from the Willamette River, it is expected to have PSI with the River. As a result, limitations on the use of surface water would be applied to the new groundwater right. As previously described, however, water is available in the Willamette River above the Molalla River at 80 percent exceedance each month of the year. So surface water availability does not impose any limitations on the use of groundwater.

Basin Program Administrative Rules: OWRD's Willamette River basin program administrative rules "classify" groundwater for municipal use. In addition, because the proposed well will likely be within one-quarter mile of the Willamette River, the basin program rule classifications for surface water would also apply. As described above, the classified uses of water from the mainstem Willamette River below the Calapooia River (near Albany) include the use of water for municipal purposes. As a result, OWRD should find the use of groundwater for the proposed use to be consistent with the Basin Program rules.

Injury: Except for two irrigation wells located at the east side of the area on the north side of the river next to the Highway 219 bridge, no other wells are located in the areas of interest for an alluvial aquifer source. While the likelihood that OWRD would find the new use would cause injury if a new well(s) was installed on the west side of the floodplain area is low, this issue should be evaluated in the event the City determines to further evaluate whether to install a well(s) in this area.

Other Rules of the Water Resources Commission: Finally, OWRD will evaluate whether the proposed use of water is consistent with other OWRD administrative rules. In this case, the rules that OWRD would consider would be those related to current well construction standards and Division 33 rules (related to listed fish species).

As part of its review OWRD will evaluate whether the construction of the well proposed for use in the permit application meets current water well construction standards (as provided in the agency's administrative rules in OAR 690-210). If OWRD identifies a construction issue, OWRD will require that the construction of the well be modified to meet standards before a water use permit is issued.

As described above, OWRD will also request input from ODFW and DEQ about impacts of the proposed water use on listed fish and fish habitat. However, ODFW and DEQ typically have not recommended any additional permit conditions for groundwater applications.

The process for acquiring a new groundwater permit (assuming the application meets all of the requirements) is expected to take approximately one year. The City should secure a water right, whether through a transfer or obtaining a new permit, prior to beginning construction of a supply source. There is a high likelihood of obtaining a water right, but the City should be aware of the intrinsic risk whenever a water right transaction occurs. OWRD may impose restrictions, curtailments, or other limitations on a new water right.

Transferring an Existing Groundwater Right

The City may potentially move one or more of its existing groundwater rights to appropriate water from a well(s) on the north side of the Willamette River. To change the authorized point of appropriation (well) for an existing water right certificate, a water right transfer application must be filed with OWRD.

The agency will evaluate a transfer application to determine whether the requested change would cause “injury” to existing water rights or “enlargement.” Additionally, since a transfer cannot change the source of water appropriated, the new well would need to appropriate water from the same aquifer from which the current well appropriates water. Although the new well(s) would be located across the river from the current wells operated under the permit, OWRD is likely to conclude that the well(s) would draw from the same aquifer because the flood plain alluvial sediments are both in connection with the river.

The proposed change would not be expected to cause enlargement because use at the new well would be limited to the amount that could be used at the original well. Finally, the change would not be expected to cause injury to existing water rights. However, the City should complete additional analysis in consultation with OWRD to verify this assumption given the presence of two irrigation wells and a surface water right on Spring Brook within the same floodplain area as the CPRD properties.

Subsurface Storage Alternative: Aquifer Storage and Recovery

ASR is the underground storage of treated drinking water in a suitable aquifer and the subsequent recovery of the water from the same well or wells, generally requiring no re-treatment other than disinfection. A suitable aquifer is capable of storing sufficient volumes and supports recovery rates that meet the City’s needs. Based on the City’s goal of developing 2 mgd (1,388 gpm) of redundant capacity, and assuming a recovery period of up to 90 days, 190 million gallons of storage is needed. (OWRD typically allows recovery of up to 95 percent of the annual storage volume.) The ideal geologic setting for ASR is a confined and relatively productive aquifer of sufficient extent to accommodate the target storage volume. In the Newberg area, the basin-fill sediments and alluvial sediments are ill-suited for ASR, whereas, the CRBG hosts several operational ASR systems in Oregon.

The two most important criteria for determining whether ASR is feasible are the availability of excess treated source water for storage and the presence of a suitable aquifer. Potential challenges with other feasibility factors, such as infrastructure needs, land ownership/use and geochemical compatibility between the storage aquifer, native groundwater and ASR source water, generally can be addressed with engineered and administrative solutions.

Based on our review of the regional hydrogeology and other factors, developing an ASR system capable of delivering 2 mgd to the City for an extended period would face significant challenges. While several successful ASR systems target the CRBG in the Tualatin Basin and northern Willamette Valley, the CRBG in the highland areas surrounding the City of Newberg appears to be a faulted and highly bounded system. Compartmentalization of the CRBG aquifers have significant potential to limit achievable recovery rates and storage volumes. The compartmentalized nature of the CRBG also presents a higher risk of excessive interference with existing water users. Recently-applied OWRD conditions that commonly limit new wells completed in the CRBG to one interflow zone also may limit recovery and injection rates, thus requiring additional wells to meet capacity goals.

An order-of-magnitude estimate of the number of ASR wells needed to achieve a cumulative recovery rate of 2 mgd in the Parrett Mountain and Chehalem Mountain areas is 6 to 10, based on an initial survey of the average pumping capacities of existing higher-yielding wells (150 – 250 gpm). However, the feasibility of any particular location is highly uncertain, potentially requiring testing of many more sites to identify suitable locations. We do not recommend further evaluation of this alternative at this time because of (1) the high number of locations that would need to be tested and developed, (2) the

high cost to develop each site, including the well, ASR pump station, piping and disinfection and (3) high uncertainty regarding the suitability of the CRBG aquifers in the area for ASR.

Groundwater Supply Alternatives

This evaluation of alternatives for developing additional groundwater source capacity focuses on groundwater withdrawal from the alluvial flood plain sediments (alluvial aquifer). Consistent with findings of previous studies, the alluvial aquifer provides the City with the best opportunity for developing an additional 2 mgd of source capacity, based on current knowledge. Developing source capacity from other aquifers, including the CRBG, basin-fill sediments and marine sediments were eliminated from further consideration for the following reasons:

- The presence and suitability of the CRBG as a long-term supply source within the City is unknown and would require a significant investment to explore, and the potential for the CRBG to provide a sufficient source of supply where known to be present outside the GWLAs is low.
- Neither the basin-fill sediments nor the marine sediments appear to be able to support wells of sufficient capacity to supply the rates and quantities needed by the City.

Two basic alternatives for developing source capacity in the alluvial aquifer are available to the City. One alternative is to develop additional capacity in or near the City's Marion County wellfield on the south side of the river. This is the alternative with the highest certainty and has some other advantages. However, it does not address the City's primary objective with regards to this next increment of source capacity: to develop redundancy on the north side of the river. The second alternative is to evaluate the feasibility of developing capacity in locations where the alluvial aquifer is present on the north side of the river. This alternative accomplishes the City's objective of developing source redundancy on the north side of the river but has higher associated uncertainty.

These general alternatives were evaluated relative to two key feasibility criteria: water rights permitting and favorable hydrogeology. The more favorable alternatives identified were further evaluated for advantages and disadvantages relative to other feasibility criteria listed below:

Property Ownership and Land Use: The availability of land and land use authorization for development of a well(s). Preference is for publicly-owned parcels zoned for land uses compatible with siting a municipal water source.

Water Quality: Potential water quality and types of treatment needed. The City currently treats its groundwater supply to remove iron. The City does not currently have capabilities to treat surface water or groundwater under the direct influence of surface water.

Infrastructure: The proximity of the site(s) to treatment and distribution piping capable of conveying 1 to 2 mgd of additional supply capacity.

Source vulnerability: Proximity of known contamination or land uses with a potential to adversely affect source water quality. The former Yamhill County landfill and known Department of Environmental Quality (DEQ) cleanup sites are examples (Figure 3).

The following sections summarize the feasibility of developing a groundwater source in the alluvial aquifer and the benefits, risks and an approach to further evaluating each alternative.

Marion County Wellfield Capacity Expansion Alternative

The City completed several studies since 1980 to evaluate the potential to develop groundwater supplies from the alluvial aquifer within the floodplain on the south side of the river. The outcome of these studies was continued expansion of the City's Marion County wellfield, centered on the thickest known section of saturated aquifer. The City has fully developed the pumping capacity of the majority of this channel feature, although the capacities of two wells (4 and 5) are diminished, potentially because of biofouling. While the aquifer becomes appreciably thinner northwest and south of the wellfield (Figure 2), the thickness and nature of the aquifer and potential presence of additional channel features have not been fully explored on the south end of the City's parcel, nor in the northerly portions of the adjacent parcel. The presence of undeveloped alluvial aquifer on the City's parcel and adjacent areas, and the diminished capacity of the City's older wells (particularly Well 4) present a couple of potential opportunities for developing additional capacity on the south side of the river, which could be implemented independently or collectively:

- 1) Evaluate whether the capacities of Well 4 and Well 5 can be restored and/or whether replacing Well 4 would be beneficial
- 2) Fully explore the City's parcel and nearby areas, and drill a new well(s) based on the results of this assessment

While additional source capacity within or near the City's Marion County wellfield does not address the City's primary objective of developing 2 mgd of redundancy on the north side of the river to improve system resiliency, the alternative has a few inherent advantages:

- The City owns the parcel occupied by the wellfield and has existing land use approvals to utilize the parcel, which is designated for exclusive farm use (EFU), for municipal drinking water source.
- Much of the access, power and conveyance infrastructure necessary to add capacity is already in place.
- The City holds undeveloped water right capacity for this aquifer, and changes to the City's water rights to add or move well locations should be relatively simple.

The primary disadvantage of this alternative is that this redundant capacity also would rely on the conveyance across the river and not provide the level of resiliency the City seeks by locating redundant capacity on the north side of the river. Another disadvantage is that the yield of individual wells may be lower than the City's existing wells, resulting in a higher cost per unit capacity. The approach and general steps for developing additional source capacity in or near the Marion County wellfield are summarized below:

Improve/Replace Existing Wells

This option would involve evaluating whether the performance of older existing wells 4 and 5 could be restored to improve overall source capacity, and if not, whether the City should consider replacing Well 4. The performance and capacities of wells 4 and 5 have been significantly diminished since originally installed. Recent advances in well assessment and rehabilitation methods may better inform the City whether to continue to operate these assets as-is or consider implementing a thorough and structured rehabilitation program to restore their capacity. One possible conclusion of the assessment would be that completing a comprehensive rehabilitation program would not be worthwhile. The evaluation could also include an assessment of whether replacing Well 4 would significantly improve overall source

capacity given that Well 4 is located at a sufficient distance from the remainder of the wells such that it would be less affected by interference from other wells.

Implementation of this option would include the following steps:

- 1) Complete a comprehensive assessment of Well 4 and potentially Well 5 to develop a full understanding of the causes of well fouling and diminished well performance. The assessment would initially involve review of information from prior assessment and rehabilitation efforts, including well videos, performance testing, water quality data and rehabilitation methodologies used. The information review would be followed by targeted water quality and bacteriological testing, and possibly a well video survey
- 2) Develop a structured rehabilitation program to target the mechanisms of fouling and evaluate potential effectiveness
- 3) Evaluate potential capacity gains to be achieved by replacing Well 4
- 4) Complete a cost/benefit analysis
- 5) Implement a structured rehabilitation program, depending on results of cost/benefit analysis

Drill New Wells on City or Adjacent Parcel

CH2M Hill (1992) estimated that the capacity of a new well drilled within the thinner (~20 feet) section of the alluvial aquifer would be between 450 and 700 gpm. However, the well capacity potential for certain portions of the City's parcel and the adjacent western parcel is not well understood because the depth, thickness and nature of the alluvial aquifer has not been fully explored. This option would involve filling in gaps in knowledge of the thickness of the alluvial aquifer on the City's parcel and developing the desired capacity increment by installing wells in the most advantageous locations on the basis of well capacity, property, permitting and infrastructure (power and conveyance) costs. The initial phase of this option would explore the extent and thickness of the aquifer on the adjacent parcel to fully understand the resource capacity of the parcels:

- 1) Negotiate an agreement with the owner of the parcel adjacent to the City's property.
- 2) Conduct a surface geophysical survey using time-domain electromagnetic (TDEM) methods, which has been proven effective at identifying and quantifying the thickness of the alluvial aquifer in environment of the Marion County wellfield.
- 3) Identify the most promising locations for installing a well(s) based on aquifer thickness and well interference.
- 4) Install a test boring to confirm the select location(s) is favorable for a production well
- 5) Develop a cost/benefit analysis based on projected well capacity and costs for permitting, installing a production well, installing the pumping system and controls, and connecting the well to the conveyance system.
- 6) Amend the City's groundwater permit to move or add the prospective well locations.
- 7) Install, test, and connect one or more production wells, as needed

North Side Capacity Expansion Alternative

This alternative involves developing source capacity in the alluvial aquifer on the north side of the river. Target areas for exploring the presence and nature of the alluvial aquifer include: (1) the floodplain on either side of Highway 219, termed the Gearns Ferry Area, and (2) the floodplain between Rogers Landing County Park (Rogers Landing) and the City of Dundee, referred to below as the Southwestern Area. The general locations of these areas are shown in figures 1 and 3.

Prior studies also identified Willamette Greenway State Park as an additional alternative for developing a source on the north side of the river. However, the park is located approximately 4 miles east of the City, and because of the high cost to install conveyance to the water treatment plant is not considered further in this evaluation.

Developing source capacity at one of these two locations addresses the City's primary objective of developing 2 mgd of redundancy on the north side of the river to improve system resiliency. Other advantages include the availability of publicly-owned property, and water rights currently held by the City could be utilized for wells completed in the alluvial aquifer. Also, wells completed in the vicinity of the Gearns Ferry Area indicate productive aquifer materials are present at least in some areas. However, potential well yields and water quality at the possible target are uncertain because neither location has been adequately explored. Past and present land uses at both locations require further evaluation to understand whether they pose a potential risk to source water quality. Both areas would require installing up to a mile of piping to convey raw water from the areas to the City's water treatment plant. A summary of the issues and general steps associated with evaluating and developing additional source capacity in the target areas on the north side of the river are summarized below.

Gearns Ferry Area

The Gearns Ferry Area was identified during previous groundwater supply studies as potentially having favorable conditions for developing a groundwater supply source from the alluvial aquifer (CH2M Hill, 1997). The Gearns Ferry Area includes two parcels owned by Chehalem Parks and Recreation District (CPRD) adjacent to the east and west sides of Highway 219 (Figure 4). The remainder of the Gearns Ferry Area is privately-owned. Nearly all of the floodplain is in cultivation, and the land is designated EFU.

The City completed a limited evaluation of the groundwater supply potential of the eastern portion of the CPRD property in 2006 (GSI, 2006), based on the identification of productive aquifer conditions in two irrigation wells located on the Willamette Farms property to the east of the CPRD parcel and an irrigation/domestic well located to the west (Figure 4). The investigation included drilling an exploratory borehole on the east edge of the CPRD property and water quality testing of the Willamette Farms wells. Although the test borehole did not intercept a thick sequence of productive material, the majority of the CPRD property remains unexplored and appears to have potential to host a thicker sequence of productive alluvial aquifer materials. The 2006 investigation did identify the presence of cyanide in a sample from one of the Willamette Farms wells, most likely a residue from agricultural chemical use. Consequently, additional investigation of groundwater quality and current agricultural practices at the Willamette Farms and CPRD parcels, as well as water quality testing on the CPRD site, would be necessary to assess the risks to source water quality prior to investing in a supply source at this location.

As indicated above, further investigation is necessary to evaluate the feasibility of developing a groundwater source at the CPRD property to address the two primary data gaps: (1) verify the presence and pumping capacity of the aquifer, and estimate well yields; and (2) evaluate groundwater quality and current and potential future agricultural practices to assess risks to source water quality. We recommend the following approach for the feasibility evaluation:

1. Meet with OWRD hydrogeologists and permit specialists to review any potential concerns or constraints to be addressed in applying for a transfer to add a new well(s) at this location to the City's existing water rights.
2. Complete a surface geophysical survey (TDEM) of the CPRD property to identify the distribution, depth and thickness of coarse-grained alluvial aquifer materials.
3. Sample the Willamette Farms and any other identified wells completed in alluvial aquifer, and analyze for a complete suite of inorganic and synthetic organic compounds, including pesticides, fungicides and herbicides.
4. Conduct outreach to the adjacent landowners to gage support for a wellfield project on EFU land
5. Interview owners/managers of adjacent properties and lessees of the CPRD property to review current and planned future farm practices.
6. Drill two to three test borings using roto sonic techniques to verify the results of the geophysical survey, collect water quality samples and identify a location(s) for advancing a test well. The test borings will target locations where geophysics indicates a substantial thickness of alluvial aquifer is present at least 200 feet from the river to avoid the presumption that groundwater is under the direct influence of surface water, and therefore requires treatment.
7. Complete a test well and complete a long-term aquifer test and water quality sampling.
8. Should the results of the investigations demonstrate that the desired capacity of acceptable quality can be developed, prepare a conceptual design and costs for a well(s), pump and controls, conveyance and treatment plant upgrades to bring the new source online.
9. Submit a transfer application to add a new well(s) to one of the City's existing alluvial aquifer water rights.

Southwest Area

The Southwest Area encompassing the floodplain between Rogers Landing and the City of Dundee is the other proximal area with potentially-favorable hydrogeologic conditions for development of a groundwater source of supply in the alluvial aquifer on the north side of the river (Figure 5). However, this particular area has several challenges and thus is less preferable than the Gearn's Ferry area. First, little information is available from which to assess the yield potential in this area. Also, the only publicly-owned property potentially suitable for development of a groundwater source is the Rogers Landing, located at the north end of the floodplain. A closed landfill is located between Rogers Landing and Dundee, approximately ¼-mile from the western edge of the park. The potential for contamination related to the landfill to affect a groundwater source installed in this area requires scrutiny. The land located between the landfill and the City of Dundee is privately-held agricultural land designated EFU, which may present some access and land use challenges.

Similar to the CPRD property, further investigation is necessary to evaluate the feasibility of developing a groundwater source in the Southwestern Area to address two primary data gaps: (1) verify the presence and pumping capacity of the aquifer, and estimate well yields; and (2) evaluate groundwater quality, potential landfill impacts, and current and potential future agricultural practices to assess risks to source water quality. We recommend the following approach to evaluate the feasibility of developing a groundwater source in the Southwest Area:

1. Complete a surface geophysical survey (TDEM) of the select location to identify the distribution, depth and thickness of coarse-grained alluvial aquifer materials.
2. Conduct outreach to the adjacent landowners to gage support for a wellfield project on EFU land.
3. Interview owners/managers of adjacent agricultural properties to review current and planned future farm practices.
4. Drill two to three test borings to verify the results of the geophysical survey, collect water quality samples and identify a location(s) for advancing a test well. The test borings will target locations where geophysics indicates a substantial thickness of alluvial aquifer is present at least 200 feet from the river to avoid the presumption that groundwater is under the direct influence of surface water, and therefore requires treatment.
5. Complete a test well and complete a long-term aquifer test and water quality sampling.
6. Should the results of the investigations demonstrate that the desired capacity of acceptable quality can be developed, prepare a conceptual design and costs for a well(s), pump and controls, conveyance and treatment plant upgrades to bring the new source online.
7. Submit an application to add a new well(s) to one of the City's existing alluvial aquifer water rights.

Summary

The City desires to develop 2 mgd of new source capacity to provide redundancy and service future growth. Ideally, the new source capacity would be located on the north side of the river to improve system resiliency by reducing dependence on the City's sole source of supply, the Marion County wellfield, which is located across the Willamette River. While this evaluation is focused primarily on groundwater source alternatives, three general alternatives for developing additional source capacity were assessed varying degrees. The general alternatives and scope of this evaluation for each are as follows

1. New Willamette River surface water supply: evaluation of water rights considerations only
2. Subsurface storage using ASR: initial desktop assessment of the potential to develop an ASR system with 2 mgd of recovery capacity based on hydrogeological conditions
3. Additional groundwater source capacity: identification and evaluation of alternatives for expanding the capacity for the City's existing Marion County wellfield and developing a new groundwater source on the north side of the river, including water rights considerations and roadmaps for implementation

Willamette River Surface Water Source

The assessment of the potential to develop a surface water source from the Willamette River was limited to a review of water rights considerations. At present GSI anticipates that OWRD would issue the City a new permit for the proposed use of surface water from the Willamette River. The City may, however, be unable to obtain water under the permit during periods of low flow due to conditions that are expected to be included in the permit. Use can be curtailed during times when the Willamette River does not meet target stream flows (as determined by the Oregon Department of Fish and Wildlife and

the Oregon Department of Environmental Quality). For example, target flows were not met during the summer of 2015 for a total of 142 days.

An alternative to obtaining a new surface water permit would be to purchase an existing surface water right, ideally one that does not have the same conditions to which a new permit would be attached. A detailed analysis of a transfer would require identification and review of a water right to be transferred. Typically transferring water downstream will not be determined to cause injury or enlargement. Also, on the Willamette River it may also be possible to transfer an existing water right to a new location upstream under certain circumstances. In the absence of viable subsurface storage options, the City's most reliable alternative for developing a surface supply would be to identify and transfer an existing, certificated water right.

Subsurface Storage using ASR

Based on our review of the regional hydrogeology and other factors, developing an ASR system capable of delivering 2 mgd to the City for an extended period would face significant challenges. An order-of-magnitude estimate of the number of ASR wells needed to achieve a cumulative recovery rate of 2 mgd in the Parrett Mountain and Chehalem Mountain areas is 6 to 10, based on an initial survey of the average pumping capacities of existing higher-yielding wells (150 – 250 gpm). However, the feasibility of any particular location is highly uncertain, potentially requiring testing of many more sites to identify suitable locations. Implementation of this alternative would entail acquiring a sufficient number of suitable sites, testing each site and developing suitable sites. Assuming feasible based on site availability and hydrogeological conditions, the cost of each increment of capacity would likely be prohibitive. , For these reasons, we do not recommend further evaluation of this alternative at this time.

Groundwater Supply Development

Of the four primary aquifer systems in the Newberg area, only the alluvial aquifer, present within the Willamette River floodplain, appears to have the potential to develop a 2 mgd supply. Two potential alternatives for development of the desired capacity from the Alluvial Aquifer are available to the City:

1. Enhance and expand the capacity of the existing Marion County wellfield by rehabilitating or replacing existing underperforming wells and/or developing new wells on undeveloped portions of the City's or adjacent properties.
2. Develop a new source of supply on the north side of the river at one of two locations where the Alluvial Aquifer appears to be present: the Southwestern and the Gearn's Ferry areas.

Enhance or Expand Capacity of Marion County Wellfield

This alternative includes several intrinsic advantages, including the presence of existing conveyance, property ownership and somewhat less uncertainty about the hydrogeological conditions. However, the City's resiliency objective is not addressed by developing additional capacity on the south side of the river. This general alternative includes two options, (1) rehabilitate and/or replace existing wells to increase capacity, or (2) drill new wells in undeveloped portions of the City's parcel or the adjacent parcel located to the west. Both options could be implemented with only minor modifications to the City's existing water rights.

Rehabilitate and/or replace existing wells: This option would involve evaluating whether the performance of older existing wells 4 and 5 could be restored to improve overall source capacity, and if not, whether the City should consider replacing Well 4. An advantage of this option is that it could maximize the utility of existing wells and distribution infrastructure.

Drill new wells on City or adjacent parcel: This option would involve filling in gaps in knowledge of the thickness and permeability of the alluvial aquifer for certain portions of the City's parcel and the adjacent western parcel, and developing the desired capacity increment by installing wells in the most advantageous locations on the basis of well capacity, property, permitting and infrastructure (power and conveyance) costs.

North Side Capacity Expansion Alternative

This alternative involves developing source capacity in the alluvial aquifer on the north side of the river in either the Gearns Ferry Area, or the Southwestern Area (figures 1 and 3). Developing source capacity at one of these two locations addresses the City's primary objective of developing 2 mgd of redundancy on the north side of the river to improve system resiliency. Other advantages include the availability of publicly-owned property, and water rights currently held by the City could be utilized for wells completed in the alluvial aquifer. Also, wells completed in the vicinity of the Gearns Ferry Area indicate productive aquifer materials are present at least in some areas. However, potential well yields and water quality at the possible target are uncertain because neither location has been adequately explored. Past and present land uses at both locations require further evaluation to understand whether they pose a potential risk to source water quality. Both areas would require installing up to a mile of piping to convey raw water from the areas to the City's water treatment plant.

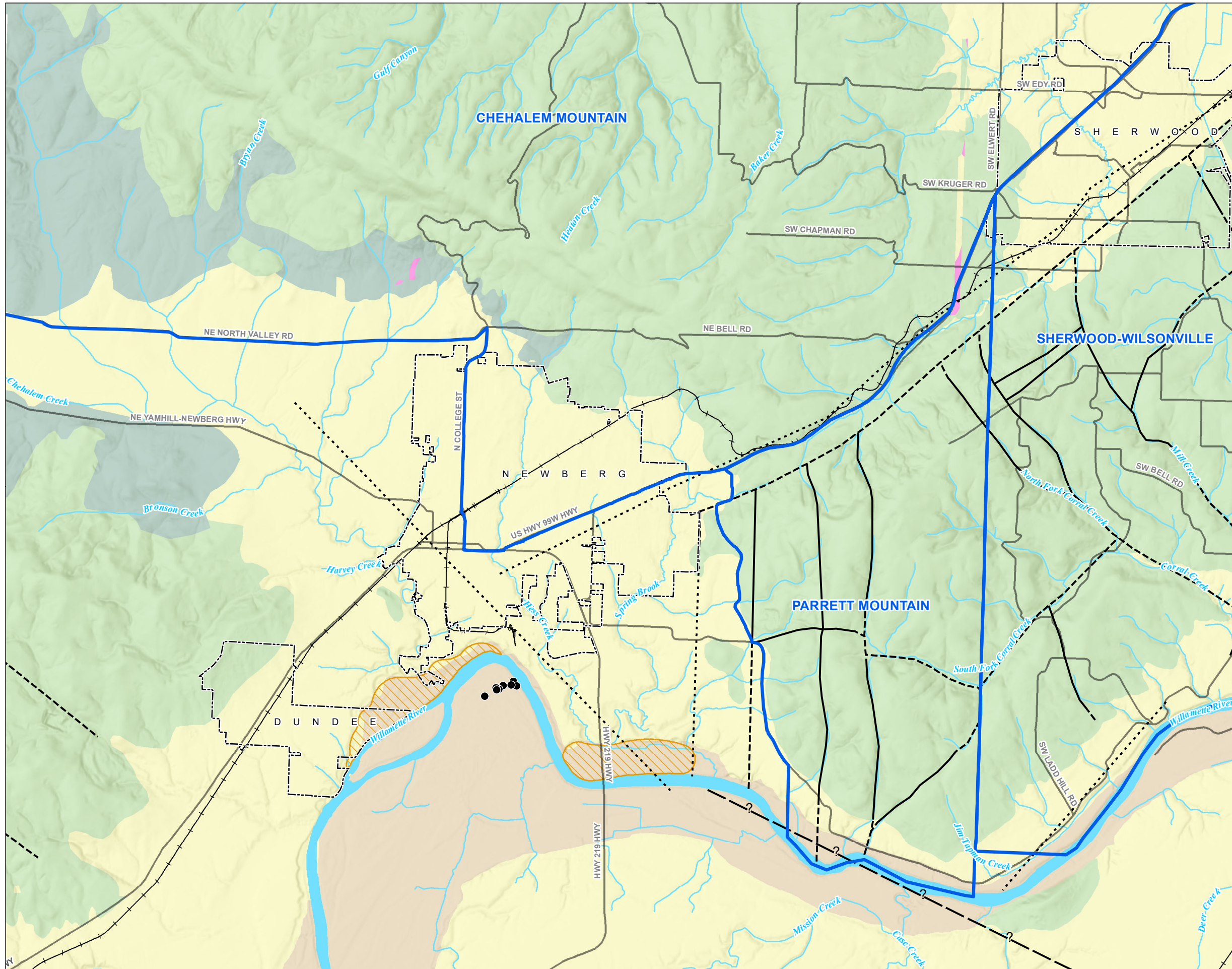
References

- CH2M Hill, 1992. City of Newberg, well field evaluation study. Report dated October 1, 1992.
- CH2M Hill, 1993. City of Newberg Ranney collector feasibility study. Report dated December 22, 1993.
- CH2M Hill, 1997. City of Newberg preliminary groundwater availability study. Technical memorandum dated July 17, 1997.
- CH2M Hill, 2000. Newberg wellfield exploration, test well installation, pump test, and well interference analysis. Report dated March 9, 2000.
- Conlon, T.D., Wozniak, K.C., Woodcock, D., Herrera, N.B., Fisher, B.J., Morgan, D.S., Lee, K.L., and Hinkle, S.R. Ground-water hydrology of the Willamette Basin, Oregon. U.S. Geological Survey Scientific Investigations Report 2005-5168, 83 p.
- Frank, F.J. and C.A. Collins, 1978. Groundwater in the Newberg Area, Northern Willamette Valley, Oregon. U.S. Geological Survey and State of Oregon Water Resources Department, Groundwater Report No. 27.
- GSI, 2006. Gearns Ferry property investigation. Memorandum from Jeff Barry to Dan Danicic, City of Newberg.
- Miller, D.W., Gates, S.M., Brodersen, B.T., and Zwart, M.J., 1994. Groundwater conditions of basalt aquifers, Parrett Mountain, Northwestern Willamette Valley, Oregon: Oregon Water Resources Department, Groundwater Report 40, 144 p.
- Ranney Method Western Corporation, 1980. Tigard Water District hydrogeological survey – Ranney collector feasibility report. Consultant report to Tigard Water District.
- Sweet, Edwards & Associates, Inc., 1983. Newberg well field hydrogeologic study. Consultant report submitted to Kramer, Chin & Mayo, Inc.

Figures

This page intentionally left blank.

FIGURE 1
Geologic Setting
 Expansion Assessment
 Newberg, Oregon



LEGEND

Surficial Geology

- Floodplain Deposits of the Willamette River and Major Tributaries (Younger Alluvium)
- Quarternary Alluvium (Basin-Fill)
- Tertiary Sedimentary Rocks (Basin-Fill Sediments)
- Columbia River Basalt Group (CRBG)
- Marine Sediments

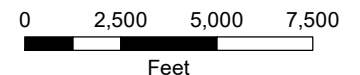
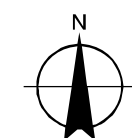
- Normal Fault
- Approximate Fault
- Concealed Fault
- Uncertain Fault

All Other Features

- City Production Well
- Potential Alluvial Aquifer Source Location
- OWRD Groundwater Limited Area
- Cities
- Major Road
- Railroad
- Watercourse
- Waterbody

NOTE:

Fault lines digitized from USGS PP-1424-A and OWRD Groundwater Report No. 40 (Miller, D.W., et al., 1994, Groundwater Conditions of Basalt Aquifers, Parrett Mountain, Northern Willamette Valley, Oregon).

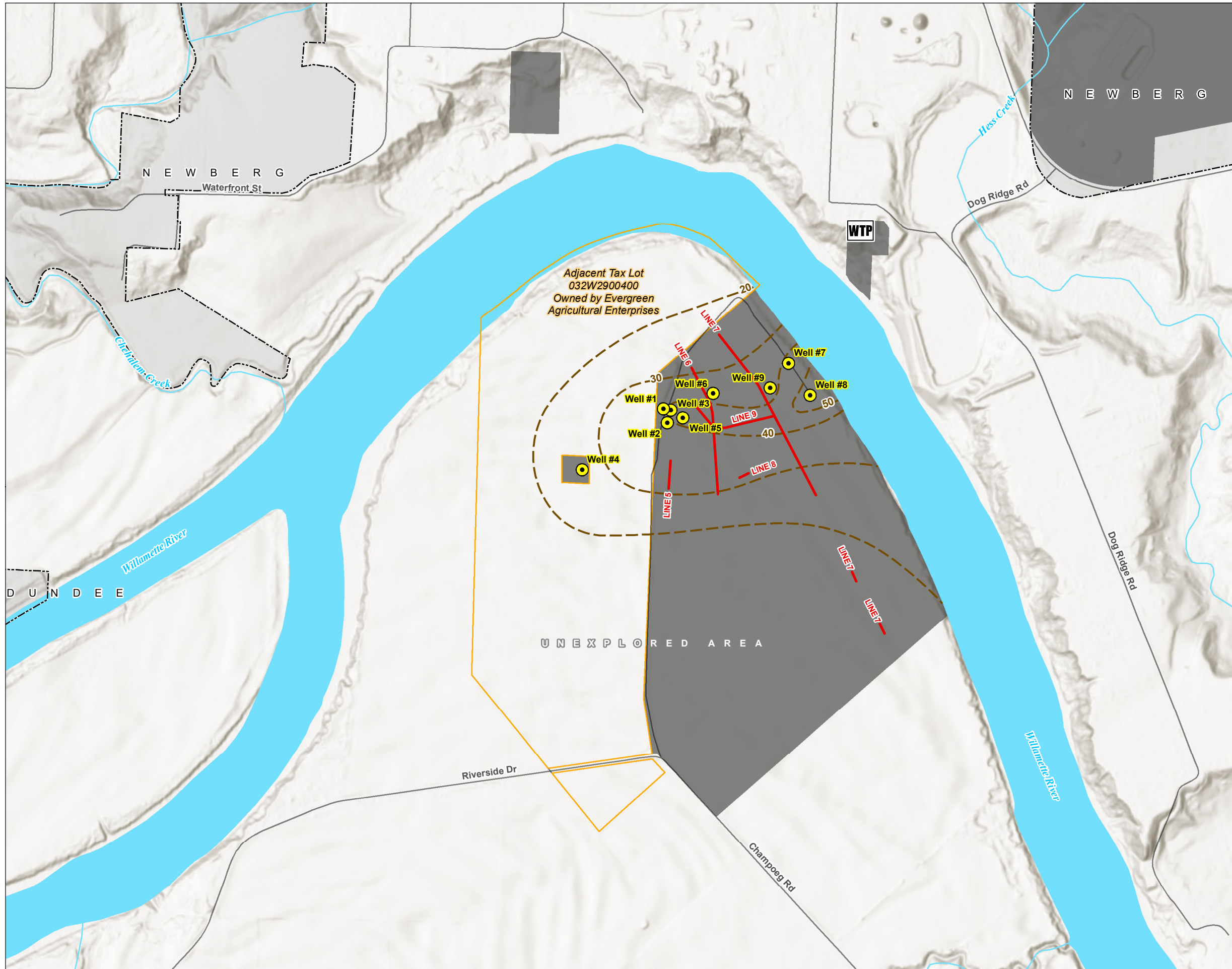


MAP NOTES:











Date: May 27, 2016
 Data Sources: Newberg, OWRD, DOGAMI, METRO, RLIS

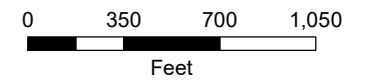


FIGURE 2
Geophysical Investigations
 Expansion Assessment
 Newberg, Oregon



LEGEND

-  Production Well
-  Geophysical Investigation Location
-  Estimated Thickness (feet) of Coarse-Grained Deposits (CH2M, 1992)
-  Newberg Water Treatment Plant
-  Cities
-  City-Owned Tax Lot
-  Adjacent Tax Lot
-  Major Road
-  Watercourse
-  Waterbody

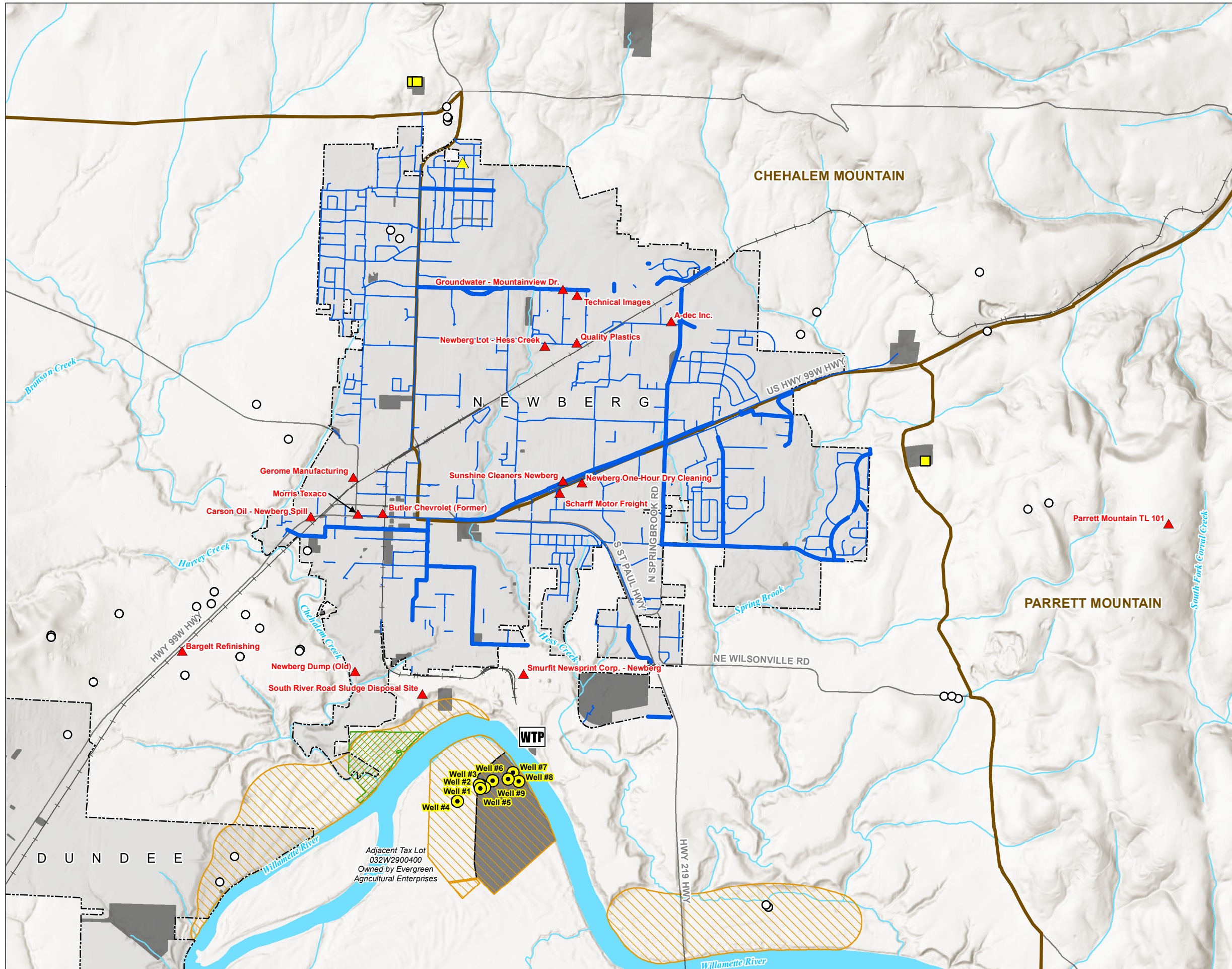


MAP NOTES:

Date: May 27, 2016
 Data Sources: Newberg, Yamhill Co GIS, Marion Co GIS, METRO RLIS, CH2MHILL Well Field Study (1992)



FIGURE 3
Potential Source Expansion Areas
 Expansion Assessment
 Newberg, Oregon



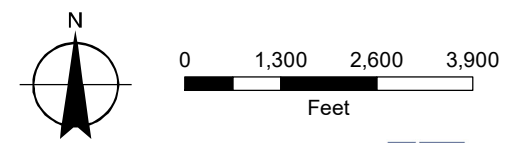
LEGEND

Distribution System

- Production Well
- Pump Station
- Enclosed Storage Facility
- Newberg Water Treatment Plant
- 8, 9, and 10 inch diameter water main (capable of distributing 700 gpm [1 MGD])
- 10 inch diameter water main (capable of distributing more than 800 gpm)

All Other Features

- DEQ ECSI Site
- Potential Alluvial Aquifer Source Location
- Groundwater Right Point of Appropriation (POA)
- Approximate Former Yamhill County Landfill
- OWRD Groundwater Limited Areas
- Cities
- City-Owned Tax Lot
- Adjacent Tax Lot to Wellfield
- Major Road
- Railroad
- Watercourse
- Waterbody

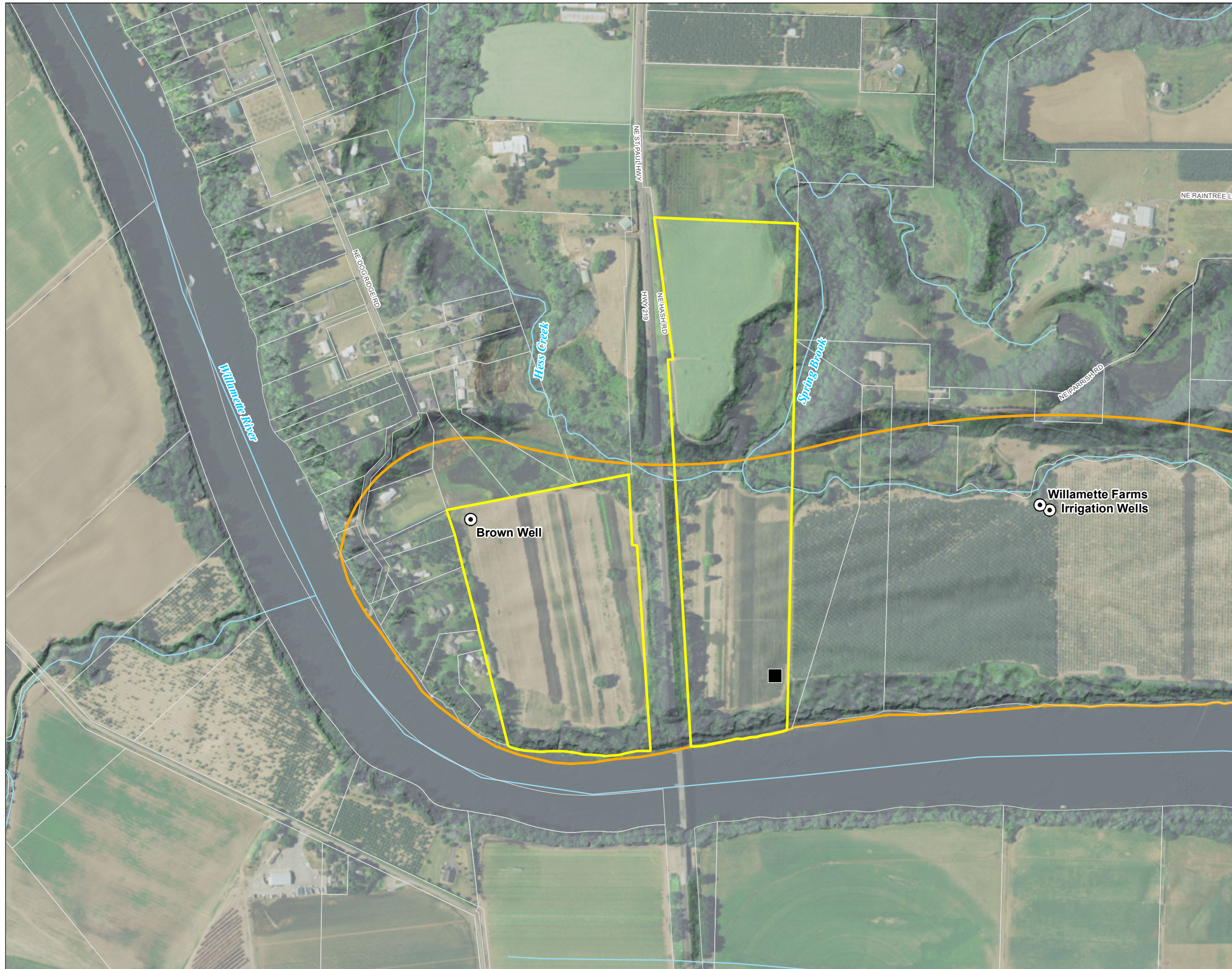


MAP NOTES:

Date: May 31, 2016
 Data Sources: Newberg, OWRD, OR DEQ, Yamhill Co GIS, Marion Co GIS, METRO RLIS

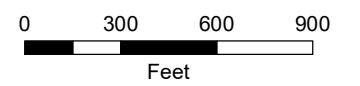
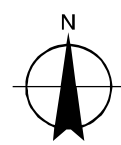


FIGURE 4
Gearns Ferry Site
 Expansion Assessment
 Newberg, Oregon



LEGEND

- Location of GSI Gearns Ferry Investigation (2006)
- ⊙ Existing Well
- ▭ Tax Lot Owned by Chehalem Valley Parks and Recreation District
- ▭ All Other Tax Lots
- ▭ Potential Alluvial Aquifer Source Location
- ~ Watercourse

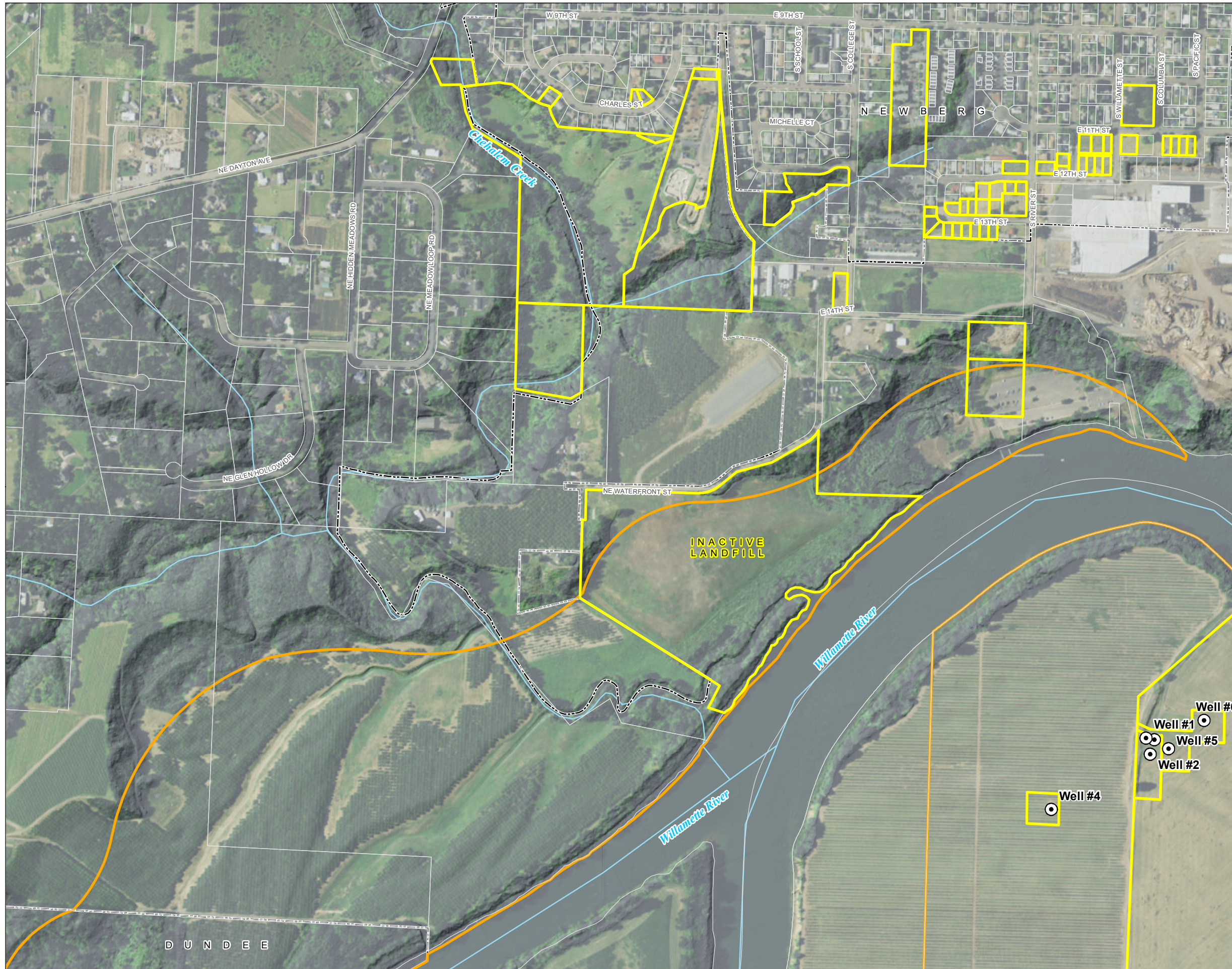


MAP NOTES:

Date: May 31, 2016
 Data Sources: Newberg, Yamhill Co GIS, Marion Co GIS, METRO RLIS, Air photo taken on June 30, 2014 by the USDA

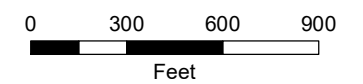
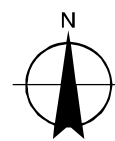


FIGURE 5
Southwest Area
 Expansion Assessment
 Newberg, Oregon



LEGEND

- ⊙ Existing Well
- ▭ Tax Lot Publicly Owned
- ▭ All Other Tax Lots
- ▭ Potential Alluvial Aquifer Source Location
- - - City Limit
- ~ Watercourse



MAP NOTES:

Date: May 31, 2016
 Data Sources: Newberg, Yamhill Co GIS, Marion Co GIS, METRO RLIS, Air photo taken on June 30, 2014 by the USDA





Methodology Report

Water System Development Charges

Prepared For
City of Newberg

February 22, 2017



Introduction

Oregon legislation establishes guidelines for the calculation of system development charges (SDCs). Within these guidelines, local governments have latitude in selecting technical approaches and establishing policies related to the development and administration of SDCs. A discussion of this legislation follows, along with the methodology for calculating updated water SDCs for the City of Newberg (the City) based on the recently completed Water System Master Plan (Murraysmith).

SDC Legislation in Oregon

In the 1989 Oregon state legislative session, a bill was passed that created a uniform framework for the imposition of SDCs statewide. This legislation (Oregon Revised Statute [ORS] 223.297-223.314), which became effective on July 1, 1991, (with subsequent amendments), authorizes local governments to assess SDCs for the following types of capital improvements:

- Drainage and flood control
- Water supply, treatment, and distribution
- Wastewater collection, transmission, treatment, and disposal
- Transportation
- Parks and recreation

The legislation provides guidelines on the calculation and modification of SDCs, accounting requirements to track SDC revenues, and the adoption of administrative review procedures.

SDC Structure

SDCs can be developed around two concepts: (1) a reimbursement fee, and (2) an improvement fee, or a combination of the two. The **reimbursement fee** is based on the costs of capital improvements *already constructed or under construction*. The legislation requires the reimbursement fee to be established or modified by an ordinance or resolution setting forth the methodology used to calculate the charge. This methodology must consider the cost of existing facilities, prior contributions by existing users, gifts or grants from federal or state government or private persons, the value of unused capacity available for future system users, rate-making principles employed to finance the capital improvements, and other relevant factors. The objective of the methodology must be that future system users contribute no more than an equitable share of the capital costs of *existing* facilities. Reimbursement fee revenues are restricted only to capital expenditures for the specific system with which they are assessed, including debt service.

The methodology for establishing or modifying an **improvement fee** must be specified in an ordinance or resolution that demonstrates consideration of the *projected costs of capital improvements identified in an adopted plan and list*, that are needed to increase capacity in the system to meet the demands of new development. Revenues generated through improvement fees are dedicated to capacity-increasing capital improvements or the repayment of

debt on such improvements. An increase in capacity is established if an improvement increases the level of service provided by existing facilities or provides new facilities.

In many systems, growth needs will be met through a combination of existing available capacity and future capacity-enhancing improvements. Therefore, the law provides for a **combined fee** (reimbursement plus improvement component). However, when such a fee is developed, the methodology must demonstrate that the charge is not based on providing the same system capacity.

Credits

The legislation requires that a credit be provided against the improvement fee for the construction of “qualified public improvements.” Qualified public improvements are improvements that are required as a condition of development approval, identified in the system’s capital improvement program, and either (1) not located on or contiguous to the property being developed, or (2) located in whole or in part, on or contiguous to, property that is the subject of development approval and required to be built larger or with greater capacity than is necessary for the particular development project to which the improvement fee is related.

Update and Review

The methodology for establishing or modifying improvement or reimbursement fees shall be available for public inspection. The local government must maintain a list of persons who have made a written request for notification prior to the adoption or amendment of such fees. The legislation includes provisions regarding notification of hearings and filing for reviews. The notification requirements for changes to the fees that represent a modification to the methodology are 90-day written notice prior to first public hearing, with the SDC methodology available for review 60 days prior to public hearing.

Other Provisions

Other provisions of the legislation require:

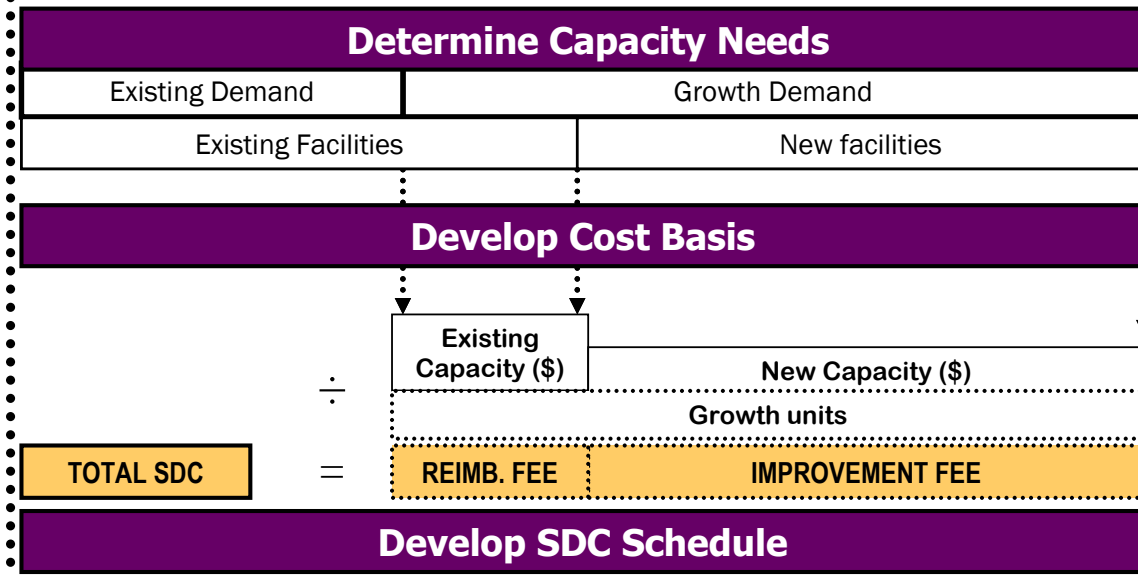
- Preparation of a capital improvement program (CIP) or comparable plan (prior to the establishment of a SDC), that includes a list of the improvements that the jurisdiction intends to fund with improvement fee revenues and the estimated timing, cost, and eligible portion of each improvement.
- Deposit of SDC revenues into dedicated accounts and annual accounting of revenues and expenditures, including a list of the amount spent on each project funded, in whole or in part, by SDC revenues.
- Creation of an administrative appeals procedure, in accordance with the legislation, whereby a citizen or other interested party may challenge an expenditure of SDC revenues.

The provisions of the legislation are invalidated if they are construed to impair the local government’s bond obligations or the ability of the local government to issue new bonds or other financing.

Methodology Overview

The general methodology used to calculate water SDCs in Newberg is illustrated in **Figure 1**. It begins with an analysis of system planning and design criteria to determine growth’s capacity needs, and how they will be met through existing system available capacity and capacity expansion. Then, the capacity to serve growth is valued to determine the “cost basis” for the SDCs, which is then spread over the total growth capacity units to determine the system wide unit costs of capacity. The final step is to determine the SDC schedule, which identifies how different developments will be charged, based on their estimated capacity requirements.

Figure 1 – Overview of SDC Methodology



Water SDC Methodology

This section presents the updated water system development charge (SDC) analysis, based on the City's recently completed Water System Master Plan (Master Plan).

Determine Capacity Needs

Table 1 shows the planning assumptions for the water system as determined by the Master Plan. Capacity requirements are generally evaluated based on the following system design criteria:

- Maximum Day Demand (MDD) -- The highest daily recorded rate of water production in a year. Used for allocating source, pumping and delivery facilities.
- Storage Requirements -- Storage facilities provide three functions: operational (or equalization) storage, and storage for emergency and fire protection needs. Used for allocating storage facility costs.

Table 1
City of Newberg
Water System Development Charge Analysis
Planning Data

	MDD (mgd) ¹	Storage (mg)
Capacity Requirements		
Current		
System	4.90	
Zone 1	4.86	5.87
High Elevation Zones	0.04	0.20
Future Requirements		
System	8.77	
Zone 1	7.35	8.8
High Elevation Zones	1.42	1.7
Growth Allocations		
System Growth	3.87	
<i>Share of Future Requirements</i>	<i>44%</i>	
Zone 1 Growth	2.49	2.93
<i>Share of Future Requirements</i>	<i>34%</i>	<i>33%</i>
High Elevation Growth	1.38	1.5
<i>Share of Future Requirements</i>	<i>97%</i>	<i>88%</i>

¹ Includes potable and non-potable systems

As shown in Table 1, system MDD is currently about 4.9 million gallons per day (mgd), including both potable and non-potable use. Growth in MDD is projected to be about 3.9 mgd over the study period. For supply and delivery purposes, the potable and non-potable

systems are evaluated on a combined basis, as collectively the systems will be used to meet future MDD.

Storage requirements are about 5.6 million gallons (mg) currently, and are limited to the potable system. Future storage requirements are expected to be 8.8 mg in Zone 1, and 1.7 mg in Zone 2. Pumping and storage requirements are evaluated separately for each zone.

Develop Cost Basis

The capacity needed to serve new development will be met through a combination of existing available system capacity and additional capacity from planned system improvements. The reimbursement fee is intended to recover the costs associated with the growth-related capacity in the existing system; the improvement fee is based on the costs of capacity-increasing future improvements needed to meet the demands of growth. The value of capacity needed to serve growth in aggregate within the planning period, adjusted for grants and contributions used to fund facilities, is referred to as the “cost basis”.

Reimbursement Fee

Table 2 shows the reimbursement fee cost basis calculations. The reimbursement fee cost basis reflects the growth share of existing system assets of June 30, 2016. As shown in Table 2, the value of the existing water system (based on original purchase cost) is almost \$44 million. When developer contributions are deducted, the City’s historical investment in water system facilities totals about \$39 million (excluding vehicles and minor equipment costs).

The growth share for each asset type is based on the planning data provided in Table 1. The existing supply, storage, and delivery system facilities all have capacity that will be utilized by future growth, and therefore the allocations are based on growth’s share of future demands. As shown in Table 1, growth share of future MDD (used to allocate supply and delivery costs) is 44 percent, and storage (based on Zone 1 requirements) is 33 percent. Support facilities are allocated 20 percent to future growth, based on the City’s estimates. The reimbursement fee cost basis excludes any assets (like the sodium hypochlorite equipment) that will be replaced by planned capital improvements. As show in Table 2, the reimbursement fee cost basis totals \$16.3 million.

Table 2

City of Newberg
 Water System Development Charge Analysis
 Reimbursement Fee Cost Basis

Description	Original	City	Growth Share	
	Cost	Cost	%	\$
Supply				
Wells	\$3,762,294	\$3,762,294	44%	\$1,660,214
Treatment	\$9,970,901	\$9,970,901	44%	\$4,399,930
Sodium Hypochlorite Equipment	\$167,464	\$167,464	0%	\$0
Springs	\$52,059	\$52,059	44%	\$22,972
Effluent Re-use	\$2,319,652	\$2,319,652	44%	\$1,023,609
Subtotal	\$16,272,370	\$16,272,370		\$7,106,726
Storage				
Corral Creek	\$3,573,002	\$3,573,002	33%	\$1,189,647
North Valley Rd. Reservoir	\$1,939,871	\$1,939,871	33%	\$645,889
Reservoir 1 & 2	\$1,157,019	\$1,157,019	33%	\$385,235
Reservoir 3	\$12,487	\$12,487	33%	\$4,158
East Reservoir	\$320,070	\$320,070	33%	\$106,569
Other	\$43,818	\$43,818	33%	\$14,589
Subtotal	\$7,046,267	\$7,046,267		\$2,346,087
Water Delivery				
Developer	\$4,576,425	\$0	44%	\$0
City Water	\$10,389,944	\$10,389,944	44%	\$4,584,844
Parallel River Line	\$3,191,301	\$3,191,301	44%	\$1,408,248
Water Line N Arterial S Curve	\$1,027,555	\$1,027,555	44%	\$453,436
Effluent Reuse	\$818,636	\$818,636	44%	\$361,245
Subtotal	\$20,003,861	\$15,427,436		\$6,807,774
Support Facilities				
3rd St. Building/Land	\$226,272	\$226,272	20%	\$45,254
2nd St. Parking	\$74,535	\$74,535	20%	\$14,907
Subtotal	\$300,807	\$300,807		\$60,161
Total	\$43,623,305	\$39,046,880		\$16,320,748

Source: City Fixed Asset Records as of June 30, 2016

Improvement Fee

Table 3 shows the improvement fee cost basis calculations. As with the existing facility costs, the costs of most planned improvements (from the Master Plan and the City's capital improvement plan) are allocated in proportion to future demands using the percentages shown in Table 1. Pumping and other high elevation water infrastructure improvements are allocated in proportion to the upper zone needs, and existing distribution main upsizing (which is specific to Zone 1) are allocated in proportion to Zone 1 MDD. System extension at Chehalem Drive and Columbia Drive, and in the nonpotable system is needed only for future growth. Support facilities are allocated 20 percent to growth based on the City's analysis.

As shown in Table 3, the total improvement fee cost basis is about \$15 million.

Table 3
City of Newberg
Water System Development Charge Analysis
Improvement Fee Cost Basis (Project List)

ID#	PROJECT	Time Period	Cost Estimate	SDC-Eligible Portion %	\$
Supply					
	2 mgd redundant supply development	2019-2023	\$3,619,000	44%	\$1,596,982
	Hypochlorite Generator	2018	\$500,000	44%	\$220,639
	Water Rights Review and Reconfiguration	2018	\$25,000	44%	\$11,032
Subtotal			\$4,144,000		\$1,828,652
Pumping					
P-1	Bell East Pump Station - Zone 3	2022-2023	\$1,450,000	97%	\$1,409,155
P-2	Bell West Pump Station - Zone 2	2019-2020	\$1,450,000	97%	\$1,409,155
Subtotal			\$2,900,000		\$2,818,310
Distribution					
M-1-M-8, M-18	Upsize existing mains; construct new distribution loops to improve fire flow capacity	2018-2022	\$2,202,000	34%	\$745,984
M-9	NE Zimri Dr Zone 3 distribution backbone within UGB	2023	\$346,000	97%	\$336,254
M-19	Chehalem Dr water system extension west and north to Columbia Dr	2018-2019	\$600,000	100%	\$600,000
M-14 & M-15	N College St - N Terrace Street - Bell West P.S. (P-2) - Veritas School	2019-2020	\$433,000	97%	\$420,803
	College Street WL to Mountain View	2018	\$470,000	10%	\$47,000
	Fixed Base Radio Read	2020	\$1,000,000	44%	\$441,277
Subtotal			\$5,051,000		\$2,591,317
Future High Elevation Water Infrastructure					
R-1	1.7 MG Bell Road Reservoir - Zone 3	20 Year +	\$2,400,000	88%	\$2,117,647
M-16	Zimri Dr. E transmission main to Bell Rd Reservoir	20 Year +	\$1,847,000	97%	\$1,794,972
M-17	Bell Rd W transmission main - N College Street to Zimri Dr.	20 Year +	\$1,726,000	97%	\$1,677,380
Subtotal			\$0		\$5,589,999
Planning					
	Seismic Resilience Study	2018	\$150,000	44%	\$66,192
	Water Management & Conservation Plan	2027	\$100,000	44%	\$44,128
	Water System Master Plan update	2027	\$250,000	44%	\$110,319
	SDC Study	2017	\$5,000	100%	\$5,000
	WTP & Bridge Transmission Main Slope Stability Study	2018	\$150,000	44%	\$66,192
Subtotal			\$655,000		\$291,830
Other					
	North non-potable water line and Otis Springs pumping improvements	2024-2027	\$1,750,000	100%	\$1,750,000
	Public Works Maintenance Facility Master Plan	2018-2022	\$737,500	20%	\$147,500
Subtotal			\$2,487,500		\$1,897,500
Total			\$21,210,500		\$15,017,608

Develop Unit Costs

The unit costs of capacity are determined by dividing the respective cost bases by the system-wide growth-related capacity requirements defined in Table 1. The system-wide unit costs are then multiplied by the capacity requirements per equivalent dwelling unit (EDU) to yield the fees per EDU. Table 3 shows these calculations.

Table 4
City of Newberg
Water System Development Charge
Unit Cost Calculations

	System Component						Total
	Supply	Storage/ Pumping	Distribution	Upper Elevation	Planning	Support	
Reimbursement Cost Basis	\$7,106,726	\$2,346,087	\$6,807,774	\$0	\$0	\$60,161	\$16,320,748
Growth Capacity Req (mgd)	3.9	3.9	3.9			3.9	
Unit Cost	\$1,836,363	\$606,224	\$1,759,115			\$15,546	
Capacity per EDU (mgd)	0.000605	0.000605	0.000605			0.000605	
Reimbursement \$/EDU	\$1,110	\$367	\$1,064	\$0	\$0	\$9	\$2,550
Improvement Cost Basis	\$1,828,652	\$2,818,310	\$4,341,317	\$5,589,999	\$291,830	\$147,500	\$15,017,608
Growth Capacity Req (mgd)	3.9	3.9	3.9	3.9	3.9	3.9	
Unit Cost	\$472,520	\$728,245	\$1,121,787	\$1,444,444	\$75,408	\$38,114	
Capacity per EDU (mgd)	0.000605	0.000605	0.000605	0.000605	0.000605	0.000605	
Improvement \$/EDU	\$286	\$440	\$678	\$873	\$46	\$23	\$2,346

EDU capacity requirements are estimated based on current MDD and the total number of meter equivalents in the system. The base service unit for the water system is a 3/4-inch meter, the standard size for a single family dwelling. The meter equivalents for larger meter sizes represent the equivalent hydraulic capacity relative to a 3/4-inch meter. **Table 5** shows the meter equivalency factors for each meter size.

Based on the existing MDD and meter equivalents, the estimated capacity requirement per EDU is 605 gallons per day (0.000605 mgd). Applying the capacity requirement per EDU by the unit costs of capacity yields reimbursement and improvement costs per EDU of \$2,550 and \$2,346, respectively as shown in Table 4.

SDC Schedule

Table 5 shows the SDC schedule for each meter size for potable and non-potable customers. The potable SDCs include the full cost per EDU shown in Table 4, while the non-potable SDCs exclude the costs of storage and upper elevation pumping and other improvements. The total SDC per EDU for potable and non-potable are \$4,896 and \$3,216, respectively. The SDCs for larger meter sizes are scaled up based on the hydraulic capacity factors.

Table 5
City of Newberg
Water System Development Charge Analysis
SDC Schedule

Meter Size	SDCr	SDCi	Potable SDC	Factor 3/4"
Potable				
3/4"	\$2,550	\$2,346	\$4,896	1.0
1"	\$4,335	\$3,989	\$8,323	1.7
1 1/4"	\$6,375	\$5,866	\$12,240	2.5
1 1/2"	\$8,415	\$7,743	\$16,157	3.3
2"	\$13,514	\$12,435	\$25,949	5.3
3"	\$25,499	\$23,463	\$48,961	10.0
4"	\$42,583	\$39,183	\$81,765	16.7
6"	\$84,145	\$77,427	\$161,572	33.0
8"	\$135,142	\$124,352	\$259,494	53.0
10"	\$195,489	\$179,880	\$375,368	76.7
NonPotable				
3/4"	\$2,183	\$1,033	\$3,216	1.0
1"	\$3,712	\$1,755	\$5,467	1.7
1 1/4"	\$5,458	\$2,581	\$8,040	2.5
1 1/2"	\$7,205	\$3,408	\$10,613	3.3
2"	\$11,572	\$5,473	\$17,044	5.3
3"	\$21,833	\$10,326	\$32,159	10.0
4"	\$36,461	\$17,244	\$53,706	16.7
6"	\$72,049	\$34,076	\$106,125	33.0
8"	\$115,716	\$54,728	\$170,443	53.0
10"	\$167,387	\$79,166	\$246,553	76.7



APPENDIX E

Addendum Riverfront Master Plan (Adopted 5/3/21)

Technical Memorandum

Date: May 2021

Project: Water Master Plan Technical Update

To: Mr. Brett Musick, PE
City of Newberg

From: Heidi Springer, PE
Murraysmith

Re: Technical Update Addendum – Riverfront water demand, performance criteria review, distribution system analysis, IBTER analysis

Introduction and Purpose

The Newberg City Council accepted the 2019 Riverfront Master Plan (RMP) on September 16, 2019. The purpose of this Water Master Plan (WMP) Technical Update Addendum is to build on and refine the proposed water infrastructure identified in the RMP. The RMP identified various infrastructure improvements necessary to support the overall vision of the Riverfront area and the development and redevelopment opportunities.

Although refining the recommended Riverfront area infrastructure was the initial goal for this WMP Technical Update, the City also identified other water system analyses and recommended improvements since 2017 which are included in this update.

The 2020 Technical Update of the City of Newberg's (City's) 2017 Water Master Plan (WMP) focused on three key areas:

1. **Riverfront** - update the 2017 WMP analysis and capital improvement program (CIP) to include the Riverfront Master Plan (RMP) area
2. **Seismic resilience** – update the 2017 WMP CIP to include recommended improvements from the City's Seismic Resilience Assessment (SRA) (HDR, 2020)
3. **IBTER** – evaluate the water system impact, if any, of potential increased density in two areas near downtown Newberg to support an Infrastructure Based Time Extension Request (IBTER) under Oregon House Bill 2001 Middle Housing implementation rules

Each of these analyses resulted in recommended changes to the City's water system CIP. This memo documents the analyses, results, and recommendations including key assumptions. This technical memorandum is not intended to meet all State requirements for a WMP update it is rather to provide supporting analysis for an amendment to the 2017 WMP. The goal of this technical update is to assist the City in planning for adequate water infrastructure to serve new development areas that were not included in the 2017 WMP and incorporate seismic resilience recommendations in the City's long-term water system planning.

Background

Riverfront

In 2019 the City accepted the Riverfront Master Plan (RMP), a re-development concept plan for a 450-acre area adjacent to the Willamette River at the southern end of Newberg's water service area. The RMP area includes the former WestRock mill site which was permanently closed in 2016 while the 2017 WMP project was in progress. At that time, the mill site and portions of the surrounding RMP area were outside of the City's water service area.

The RMP includes proposed land use for the Riverfront area which is used in this technical update to estimate future water demand for the Riverfront. The RMP also includes high-level water system improvement recommendations to serve proposed land uses and potential development in the Riverfront area. This technical update implements the RMP recommendations by conducting analysis to refine the recommended infrastructure, such as, recommended water main size and incorporating this recommended infrastructure into the City's existing WMP CIP.

Seismic Resilience

In accordance with utility planning guidelines in the Oregon Resilience Plan the City conducted a water system Seismic Resilience Assessment (HDR, 2020) to identify geohazards associated with a Cascadia Subduction Zone (CSZ) earthquake and possible impacts to vulnerable water system facilities from the CSZ. This technical update, included as **Appendix B**, incorporates recommended capital improvements and recommendations for further evaluation of specific facilities from the City's SRA. This WMP technical update does not include any additional assessment of seismic geohazards or potential water facility vulnerabilities to seismic hazards.

IBTER

This technical update includes recommended capital improvements identified as part of the IBTER analysis. The details of the IBTER analysis are documented in a separate technical memorandum included as **Appendix A**. The IBTER analysis is an estimate of the impact of increased residential housing density on water system infrastructure in two areas of the City of Newberg. Increased housing density is anticipated as a result of 2019 Oregon legislation, House Bill (HB) 2001 Missing Middle Housing, which requires updates to local laws throughout Oregon that currently limit the types of housing approved for construction in residentially zoned areas.

The City will adopt regulations that will allow for the development of duplexes and other types of middle housing in areas zoned for residential development to comply with this legislation and address needed housing types for residents at all income levels.

The IBTER analysis documented in **Appendix A** was conducted to inform an Infrastructure-Based Time Extension Request (IBTER) as described in Oregon Administrative Rules (OARs) 660-046-0300 to 0370 which became effective August 7, 2020. An approved IBTER would grant the City additional time to comply with the requirements of HB 2001 Middle Housing.

IBTER Study Areas

City staff identified two areas for infrastructure analysis to inform an IBTER:

- North of Downtown Newberg - up to the rail line that runs through Newberg to Hess Creek (**Appendix A, Figure 1**)
- South of Downtown Newberg - from the Chehalem Creek and railroad line intersection to the WestRock line and Hess Creek (**Appendix A, Figure 2**)

2017 WMP References

The City will complete an addendum to the 2017 WMP utilizing this Technical Update. To support this addendum, sections of the 2017 WMP which are impacted by analyses documented in this report are indicated in brackets throughout the text. Example: [Sect. 2, page 2-1]. Changes are summarized in **Table 9** at the end of this memo.

Water Demand Update

Water demand refers to all potable water required by the system including residential, commercial, industrial, and institutional uses. Potable water demands are described using three water use metrics, each stated in gallons per unit of time, such as, million gallons per day (mgd):

- average daily demand (ADD) - the total annual water volume used system-wide divided by 365 days per year
- maximum day demand (MDD) - the largest 24-hour water volume for a given year, occurs each year between July 1st and September 30th, historically about 2 times ADD in Newberg
- peak hour demand (PHD) - the largest hour of demand on the maximum water use day, estimated as 1.7 times MDD

Water demand can be calculated using either water consumption or water production data. Water consumption data is taken from the City's customer billing records and includes all revenue metered uses. Water production is measured as the water supplied to the distribution system from the City's Water Treatment Plant (WTP) plus the water volume supplied from distribution

storage. Water production includes unaccounted-for water like water loss through minor leaks and unmetered, non-revenue uses, such as, hydrant flushing. For the purposes of this analysis, water production data is used to estimate current water demand.

Current Demand

Table 1 summarizes the City’s current and historical system-wide water demand based on water production data from the WTP. [Table 2-1, page 2-3] As shown in **Table 1** Newberg’s system-wide demand has remained steady over the last 10 years. In general, the City’s per person water demand is declining with ADD growing approximately 7 percent and population growing 10 percent over the same period. Per person water demand is measured in gallons per capita per day (gpcd) and is used to correlate water demand with population for estimating future water demand.

Table 1
Current and Historical Water Demand

Year	Population	ADD		MDD	
		(mgd)	(gpcd)	(mgd)	(gpcd)
2010	22,110	2.23	101	4.84	219
2011	22,230	2.24	101	4.42	199
2012	22,300	2.27	102	4.76	213
2013	22,580	2.24	99	4.39	194
2014	22,765	2.31	101	4.43	194
2015	22,900	2.38	104	4.75	207
2016	23,465	2.34	100	Data not requested	
2017	23,480	2.35	100	Data not requested	
2018	23,795	2.39	100	4.72	198
2019	24,045	2.27	94	4.16	173
2020	24,120	2.34	97	4.60	191

1. Population estimates are from Portland State University Population Research Center (PSU PRC) 2019 annual report.

Estimated Future Demand

The 2017 WMP included estimated future water demand in 2035 based on anticipated population growth. Due to slower than anticipated growth since 2017, it is assumed that the 2035 water demand projection from the 2017 WMP is an adequate estimate of projected 20-year demand in 2041 within the current water service area.

Riverfront

The Riverfront area was outside of the anticipated future water service area in the 2017 WMP, thus projected demand for this area must be added to projected 20-year demands from the 2017 WMP. Potential development in the Riverfront area is estimated based on anticipated land use described in the RMP Appendix C Preferred Alternative E. Future water demand is estimated by applying an average water use per acre (non-residential) or per unit (residential) based on 2019 City water billing records. **Figure 1** illustrates estimated water demand. **Table 2** summarizes projected 20-year water demand [Table 2-3, page 2-5] including the Riverfront area.

Projected demands presented in **Table 2** assume that all future Riverfront demand will be served from Pressure Zone 1 [Table 2-4, page 2-6], the Riverfront area will reach saturation development or build-out within 20 years (by 2041), and water use characteristics will resemble those of existing Newberg water customers. Projected demands do not explicitly include high water use industries, such as, food processing or semi-conductor manufacturing.

Table 2
Projected 20-year Water Demand

20-year Demand (mgd)	ADD	MDD	PHD
2035 Demand from 2017 WMP	3.89	7.78	13.23
Riverfront demand	0.17	0.34	0.58
2041 Projected Demand	4.06	8.12	13.80

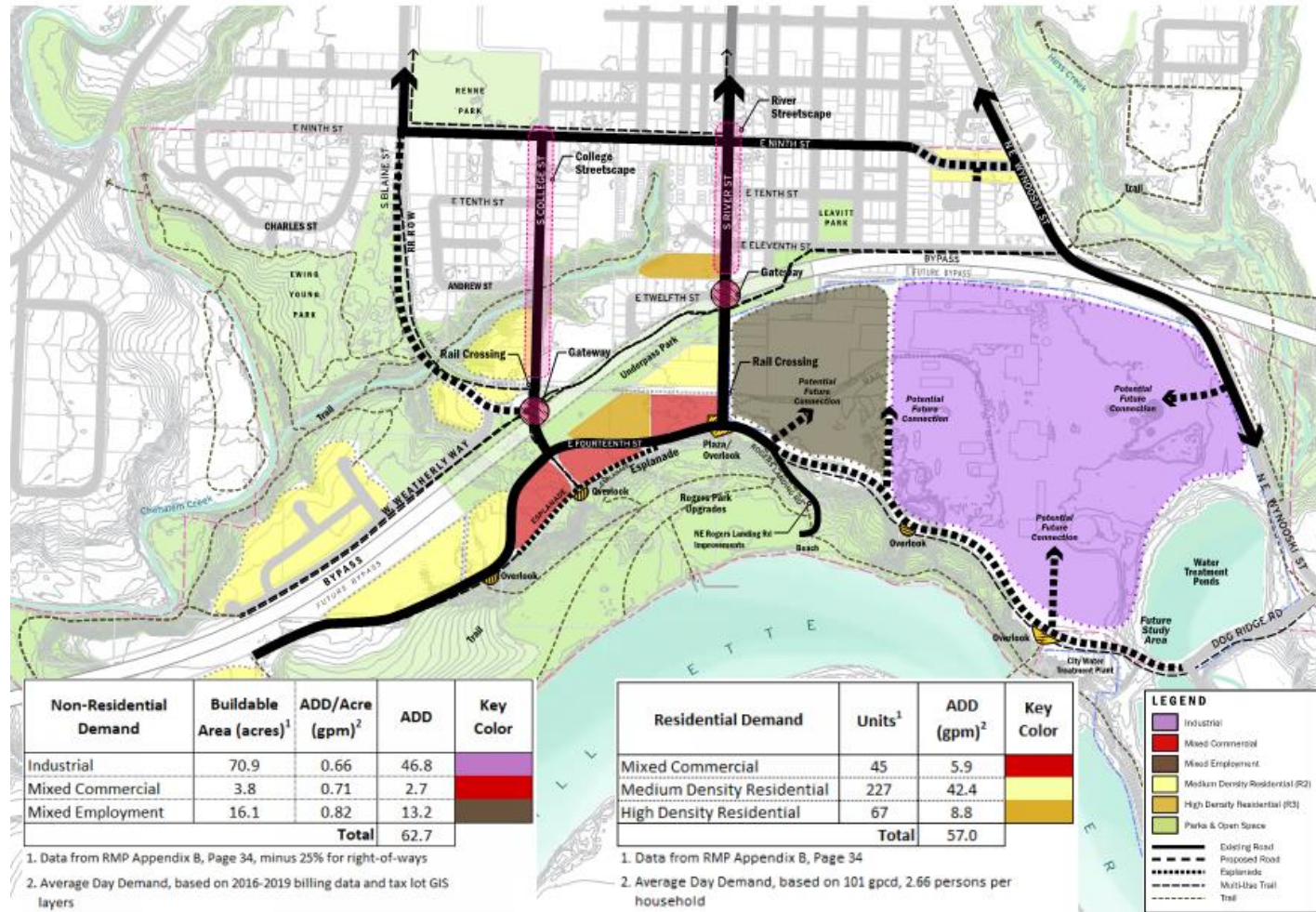
Future Demand by Zone

As stated above, all future Riverfront water demand is anticipated to be served from Zone 1. Existing demand in Zone 2 is assumed to be approximately the same as existing Zone 2 presented in the 2017 WMP. Future Zone 2 and 3 water demands projected in the 2017 WMP to occur in 2035 are assumed to occur by 2041. Future water demands for Zones 2, 3, and 4 projected to occur beyond the 20-year planning horizon in the 2017 WMP, remain beyond the new 20-year planning horizon (2041) for this analysis. Existing, projected 20-year, and build-out demand is summarized in **Table 3** [Table 2-4, page 2-6]

Table 3
Projected Future Demand by Zone

Zone	Current (mgd)		2041 (mgd)		Build-out (mgd)	
	ADD	MDD	ADD	MDD	ADD	MDD
1	2.31	2.23	3.76	7.52	3.79	7.58
2	0.02	2.24	0.27	0.54	0.27	0.54
3	-	-	0.03	0.06	0.33	0.66
4	-	-	-	-	0.11	0.22
TOTAL	2.33	4.47	4.06	8.12	4.50	9.00

Figure 1
 Estimated Water Demand – Future Riverfront Development



1. Basemapping and proposed zoning in Figure 1 taken from RMP Appendix C Preferred Alternative E.

Performance Criteria Review

Performance criteria defines water system operating standards, such as, service pressure and required supply or storage capacity. These criteria are used to evaluate the existing water supply and distribution system under existing and projected future water demand conditions. Criteria is also used to size proposed facilities to serve future growth or mitigate deficiencies in the existing water infrastructure. **Table 4** summarizes performance criteria from the 2017 WMP and proposed criteria for this WMP Technical Update [Sect. 3, Summary, page 3-8]. No changes were recommended to 2017 WMP performance criteria. Criteria was selected for required fire flow in unique Riverfront zoning designations.

Based on 2019 Oregon Fire Code (OFC) revisions, the City could elect less conservative required fire flow criteria for industrial, institutional, and hospitality zoned areas. The 2019 OFC Appendix B.105 sets a maximum required fire flow from any public water system at 3,000 gallons per minute (gpm) in areas with adequate and reliable water systems such as the City of Newberg. This 3,000 gpm requirement is less than the 4,500 gpm for this zoning documented in the 2017 WMP. Maintaining the more conservative fire flow criteria for these zoning designations did not increase the number of fire flow related CIP projects within the water service area.

Table 4
Performance Criteria Comparison Summary

Water System Component	Evaluation Criterion	2017 WMP Value	2020 WMP Update Value	Design Standard/Guideline and Comments on Differences
Water Supply	MDD Supply under Firm Capacity Conditions	Largest well out of service; 1 transmission main out of service; One treatment train out of service; Largest high-service pump out of service	No change	Washington Water System Design Manual
	Normal Range, during ADD	40-80 psi	No change	City's 2015 Public Works <i>Design and Construciton Standards</i> , Oregon Plumbing Specialty Code
Service Pressure	Maximum, without PRV	80 psi	No change	Oregon Plumbing Specialty Code 608.2
	Minimum, during emergency or fire flow	20 psi	No change	OAR 333-061
	Minimum, during PHD ²	75% of normal, not less than 30 psi	No change	Murraysmith recommended
	Velocity during PHD or fire flow	Not to exceed 8 fps	No change	City's 2015 Public Works <i>Design and Construciton Standards</i>
Velocity during ADD	Not to exceed 5 fps	No change		
Minimum Pipe Diameter	8-inch minimum for new, permanently dead-ended residential water mains and primary feeder mains in residential areas	No change		
Storage	Operational Storage	PHD for 2.5 hours with non-emergency pumps serving at full capacity	No change	Washington State Department of Health's <i>Water System Design Manual</i>
	Fire Storage	Flow times duration of most severe fire demand within each zone	No change	2019 Oregon Fire Code B106
	Emergency Storage	100% of MDD	No change	Murraysmith recommended (City has a single supply source)

Table 4
Performance Criteria Comparison Summary (continued)

Water System Component	Evaluation Criterion	2017 WMP Value	2020 WMP Update Value	Design Standard/Guideline and Comments on Differences	
Required Fire Flow and Duration	Low Density - Single Family and Duplex Residential <= 3,600 sq ft	1,000 gpm for 2 hours	No change	2014 Oregon Fire Code vs. 2019 Oregon Fire Code Appendix B, Insurance Services Office (ISO) Supply Gradings for Public Protection Classification (PPC)	
	Single Family and Duplex Residential >3,600 sq ft	1,500 gpm for 2 hours	Possible increase, not selected 1,750 gpm for 2 hours		
	Medium Density Residential	1,500 gpm for 2 hours	Possible increase, not selected 2,000 gpm for 2 hours		
	High Density Residential	2,000 gpm for 3 hours	Possible increase, not selected 3,000 gpm for 3 hours		
	Commerical	3,000 gpm for 3 hours	No change		
	Industrial, Institutional, and Hospitality	4,500 gpm for 3 hours	Possible decrease, not selected 3,000 gpm for 3 hours		
	Mixed Commercial (RMP)	-	2,000 gpm for 3 hours		Murraysmith recommended for new land use designations in Riverfront area
	Mixed Employment (RMP)	-	3,000 gpm for 3 hours		

Distribution System Analysis

The distribution system analysis is an evaluation of existing supply, finished water storage, and pumping facilities as well as distribution mains to determine if adequate capacity is available to meet the criteria defined in **Table 4** through the 20-year planning period. As previously described, projected 20-year (2041) water demands within the current water service area remain the same for this analysis as those projected in the 2017 WMP to occur in 2035. The new Riverfront area adds approximately 4 percent to the projected 20-year Zone 1 ADD for this WMP Technical Update. This minor increase in projected demand will not impact the City's Zone 1 storage or Zone 1 pumping capacity which is adequately sized for projected 20-year demands as concluded in the 2017 WMP [Sect 5, Tables 5-1 and 5-2]. Facilities recommended in the 2017 WMP to serve future growth in higher elevation Zones 2 and 3, such as the Bell Road Reservoir, are not impacted by this future Riverfront demand.

Supply

Capacity criteria documented in **Table 4** states that supply capacity must be equal to MDD. As shown in **Table 2**, projected 20-year MDD with the Riverfront area exceeds the current 8 mgd capacity of the City's WTP by 0.12 mgd. Although this indicates a supply deficiency in 20 years [Sect. 4, page 4-8], for a deficiency this small, approximately 1.5 percent of demand, it is recommended that the City manage this deficit through operational strategy rather than investing capital in constructing additional storage. This would mean using more depth in the City's existing Zone 1 storage reservoirs, North Valley and Corral Creek, to meet the small amount of demand that exceeds supply from the WTP on the 2 to 3 days of each year that system demand is expected to be over 8 mgd.

When considering an operational approach to offsetting projected future deficiencies it is also important to recognize the degrees of uncertainty involved in projecting future water demand. Planning for future water demand growth involves uncertainty in population and economic growth rates as well as customer water use volumes, conservation, and potential impacts from climate change. As growth continues in the City, projected growth rates and customer water use characteristics can be revised to represent trends more accurately at the time. As these projected demand revisions are completed, this operational strategy recommendation to address supply deficiencies should be revisited.

Distribution Mains

For the current analysis, distribution mains were evaluated using a hydraulic network analysis model developed and calibrated for the 2017 WMP. Capacity deficiencies and recommended improvements were the same as those identified in the 2017 WMP except for the Riverfront and IBTER areas. These results are as expected given the localized change in 20-year projected demand from the anticipated Riverfront development and increased fire flow requirements because of changes in zoning to accommodate future middle housing in the IBTER analysis areas. Analysis results and recommended improvements are documented in the following paragraphs. Proposed

Riverfront and IBTER piping improvement CIP projects are illustrated on **Figure 2** at the end of this memo and summarized in **Tables 5** and **6**.

Future Riverfront Distribution Mains

Distribution main alignments to serve future Riverfront development are based on proposed roadway alignments from the RMP and preliminary site plans from the Riverrun development on the north side of W Weatherly Way. Riverfront distribution mains are sized based on the projected 20-year demands summarized in **Table 2** and required fire flow based on proposed zoning from the RMP Appendix C Preferred Alternative E zoning as presented in **Table 4** and **Figure 1**.

Table 5
Proposed Riverfront Improvements

Project No.	Project Description	Estimated Cost
RMP-1	Install 2,398 LF of 12-inch DI Pipe in Wynooski Street	\$ 1,080,000
RMP-2	Install 2,447 LF of 12-inch DI Pipe in new Riverfront road between S River Street and City WTP	\$ 1,102,000
RMP-3	Install 1,422 LF of 8-inch DI Pipe in NE Waterfront Street from S College Street west to (future) crossing to S Gia Court	\$ 512,000
RMP-4	Install 1,163 LF of 8-inch DI Pipe in NE Waterfront Street from (future) S Gia Ct crossing west to loop under bypass to W Weatherly Way	\$ 419,000
RMP-5	Install 834 LF of 8-inch DI Pipe in S College Street between E 10th and E 13th Streets	\$ 301,000
RMP-6	Install 812 LF of 12-inch DI Pipe in S River Street between E 12th and E 14th Streets	\$ 366,000
RMP-7	Install 521 LF of 12-inch DI Pipe in E 11th Street between S River and S Willamette Streets	\$ 235,000
RMP-8	Install 1,001 LF of 12-inch DI Pipe in E 14th Street between S College Street and S River Street	\$ 451,000
RMP-9	Install 271 LF of 8-inch DI Pipe in S College Street between W Weatherly Way and E 14th/NE Waterfront Street	\$ 98,000
TOTAL COST		\$ 4,564,000

1. All costs in 2020 dollars.
2. Includes: costs for fittings/valves and connections to existing services and hydrants; local street trench patch resurfacing; an allowance of 30% for construction contingency, 25% for engineering, permitting and inspection, and 1% for Oregon Corporate Activity Tax (applied to construction costs only)
3. Not included: whole or half street overlay cost; easement or property acquisition costs; City project management and administrative costs

IBTER Analysis

Consistent with IBTER state guidelines, local fire flow availability and service pressure resulting from potential increased density within the IBTER study areas were evaluated. The full IBTER analysis report is available in **Appendix A**. IBTER guidelines limit estimated housing unit growth due to HB 2001 to less than 3 percent. Increased water demand for such a small percent of residential growth has no impact on water system operating pressure.

Fire Flow Availability

Fire flow availability was tested at 2,000 gpm in the IBTER study areas consistent with high density residential required fire flow from **Table 4**. This 2,000 gpm fire flow may be conservative in some parts of the IBTER study areas where smaller structures with fewer units, like duplexes, are more likely to be developed. However, providing water infrastructure capable of supplying a 2,000 gpm fire flow allows the City to consider a broader range of middle housing options as HB 2001 zoning changes are evaluated.

Fire flow availability in the south IBTER study area is constrained by high pipe flow velocity. Adequate pressure is available to supply fire flow and maintain service pressures above 20 psi for public health. However, small diameter 4- and 6-inch pipe grids in the south study area create flow velocities over 20 feet per second (fps) during a fire flow event. Fire flow in the north study area is less constrained with 8-inch diameter well looped existing mains interconnected with the 18-inch diameter North Valley Reservoirs transmission main.

The primary concern with high pipe velocity is abrasion of the interior pipe coating, which can expose the pipe material to corrosion and lead to potential pipe failure. This is generally a greater concern when high flow velocity extends over a long period of time as part of normal system operation. In the case of a fire flow event, these high flow velocities are both infrequent and for a short time when they do occur. Thus, a pipe velocity higher than the 8 fps specified in **Table 4** may be acceptable, provided there is adequate available pressure to supply fire flow as is the case in Newberg's IBTER south study area. For the purposes of this analysis available fire flow in IBTER study areas is evaluated at a flow velocity of 14 fps.

Recommended Middle Housing (IBTER) Pipe Improvements

Eight significant pipe improvement projects are recommended for the south study area and one minor project is recommended for the north study area to provide adequate fire flows to potential higher density development. In the south, existing development is primarily served from a 4- and 6-inch diameter pipe grid. While a 6-inch diameter main can provide a 1,000 gpm single-family residential fire flow, a 6-inch diameter grid does not have adequate capacity to provide a 2,000 gpm multi-family residential fire flow.

Existing 6-inch diameter mains along key corridors in the south study area, including S College Street, S River Street, and E 9th Street, are recommended to be upsized to 12-inch diameter mains to provide a large diameter backbone for the area to meet 2,000 gpm fire flow requirements for

potential higher density development. Additional looping is also recommended to connect larger diameter mains with the 18-inch diameter transmission main in Wynooski Street and for the W 4th Street neighborhood between Dayton Avenue and Hwy 99W.

Two areas in the southwest corner of the south study area cannot be supplied a 2,000 gpm fire flow without significant or total pipe replacement and upsizing. The first area is the S Charles Street loop, which is bordered by Chehalem Creek to the west making it difficult to loop with the water system outside of the south study area. The second area is between S College Street and S River Street just north of the Newberg Dundee Bypass, which does not have an existing east-west right-of-way to provide additional looping. Rather than replacing these pipes in their current alignments, it is instead recommended that the City assess fire flow to these areas and potential distribution system looping along with future transportation projects associated with the Riverfront area, such as the extension of S Blaine Street south of Ewing Young Park and the extension of a future road across the former WestRock mill property connecting the area around the City’s WTP and NE Rogers Landing Road.

Table 6
Proposed IBTER Improvements

Project No.	Project Description	Estimated Cost
I-1	Install 1,733 LF of 8-inch DI Pipe in S Main Street, W 4th Street, S Lincoln Street, and W 5th Street	\$ 624,000
I-2	Install 2,558 LF of 12-inch DI Pipe in S Blaine Street	\$ 1,152,000
I-3a	Install 28 LF of 8-inch DI Pipe in S College Street north of E 9th Street	\$ 11,000
I-3b	Install 2,934 LF of 12-inch DI Pipe in E 9th Street, Charles Street, and S College Street	\$ 1,321,000
I-4a	Install 42 LF of 8-inch DI Pipe in S Meridian Street north of E 5th Street	\$ 16,000
I-4b	Install 730 LF of 12-inch DI Pipe in S Meridian Street	\$ 329,000
I-5	Install 3,691 LF of 12-inch DI Pipe in E 7th Street, S Pacific Street, E 9th Street, and Paradise Drive	\$ 1,662,000
I-6	Install 2,736 LF of 12-inch DI Pipe in S River Street (north of the by-pass)	\$ 1,232,000
I-7	Install 453 LF of 12-inch DI Pipe in E 5th Street	\$ 204,000
I-8	Install 159 LF of 8-inch DI Pipe from E 11th Street to the Boston Square Apartments	\$ 58,000
I-9	Install 15 LF of 8-inch DI Pipe in Vermillion Street	\$ 6,000
Total Cost		6,615,000

1. All costs in 2020 dollars.
2. Includes: costs for fittings/valves and connections to existing services and hydrants; local street trench patch resurfacing; an allowance of 30% for construction contingency, 25% for engineering, permitting and inspection, and 1% for Oregon Corporate Activity Tax (applied to construction costs only)
3. Not included: whole or half street overlay cost; easement or property acquisition costs; City project management and administrative costs

Seismic Resilience

As of 2018, OARs governing WMPs require that water providers address seismic resilience in their WMPs. The City conducted a water system Seismic Resilience Assessment (SRA) in 2020 (HDR, 2020). The purpose of the SRA is to define seismic recovery goals for the City system, evaluate the expected performance of the water system during a CSZ earthquake, and identify recommended mitigation measures to address deficiencies.

Geohazards and System Vulnerability

The SRA included a review of the existing geologic and geotechnical conditions in Newberg's water service area to develop seismic ground motion, seismic hazard, and permanent ground deformation hazard maps. Water system components were compared against these seismic hazard maps showing peak ground velocity, probability of liquefaction, and landslide induced permanent ground deformation.

Based on the SRA, vulnerabilities were identified in the raw water pipeline bridge, the 30-inch raw water transmission main, the wellfield, and the WTP due to lateral spreading and soil liquefaction. In general, the SRA review of the WTP structures indicated that none meet either the structural or non-structural performance objectives outlined as part of the seismic recovery goals. The SRA noted that while the buildings will not withstand a CSZ event, the WTP site itself is not susceptible to a landslide into the adjacent Willamette River. The SRA states significant work is required at the WTP to meet recovery goals, and further evaluation is recommended to compare the cost of upgrading the WTP with building a new WTP. Follow-on analysis conducted after the SRA indicates retrofitting the WTP is the more cost-effective option for addressing these seismic vulnerabilities as presented in the seismic improvements **Table 7**.

The water distribution network is considered a lower priority for seismic resilience based on the seismic recovery goals established by the City in the SRA. Improvements are recommended in the SRA at system finished water reservoirs at the North Valley site to address hydraulic control and yard piping seismic vulnerabilities. Distribution backbone piping is also recommended for replacement with more seismically resilient materials.

Recommended Seismic Mitigation Projects

Table 7 summarizes projects recommended in the SRA to mitigate seismic vulnerabilities in the City's water facilities and water distribution backbone piping. The SRA provided a range of costs for mitigation projects as well as recommendations for additional studies needed to assess specific facilities. City staff provided final cost estimates for these projects to be included in the CIP.

Table 7
Proposed Seismic Resilience Improvements

Project	Description	Estimated Cost
Existing WTP Seismic Retrofit	Install ground improvements between WTP site and the Willamette shoreline to prevent lateral movement, strengthen structural components to withstand a CSZ	\$ 8,500,000
Emergency Connection and Controls at the WTP	Add an emergency cross-connection and hydraulic control valves to isolate the WTP during an earthquake	\$ 500,000
Improvements to North Valley Reservoirs	Add hydraulic control valves and replace a portion of the pipe at North Valley Water Storage Tanks	\$ 1,050,000
Cast Iron and Concrete Pipe Replacement - 20 year total	Replacement of more than 37,000 linear feet of old cast iron and concrete pipe	\$ 1,500,000
Seismic Resilience Planning and Studies		
	Develop new engineering standards	\$ 50,000
	Additional geotechnical investigations to define geohazards	\$ 75,000
	Investigate specific structural recommendations at existing WTP and other City facilities	\$ 100,000
	Evaluate mitigation strategies for raw water pipeline bridge	\$ 75,000
Total Cost		\$ 11,850,000

Capital Improvement Program Update

The 2017 WMP CIP project list [Table 7-5, page 7-15] was updated by:

- Removing completed projects
- Revising costs for projects with more refined City budgeted costs and adjusting for regional construction cost changes since 2017
- Adding proposed CIP projects for Riverfront, IBTER/middle housing areas, and seismic resilience as presented in **Tables 5, 6, and 7**

The proposed CIP for this WMP Technical Update is presented in **Table 8**.

Cost Estimates

An estimated cost has been developed for each recommended improvement project. For Riverfront and IBTER projects, new piping is assumed to be ductile iron pipe installed by private contractors. Seismic resilience improvement costs were taken from the SRA and refined as needed by City staff.

Cost estimates represent opinions of cost only, acknowledging that final costs of individual projects will vary depending on actual labor and material costs, market conditions for construction, regulatory factors, final project scope, project schedule and other factors. The Association for the Advancement of Cost Engineering International (ACE) classifies cost estimates depending on project definition, end usage, and other factors. The cost estimates presented here are considered Class 4 with an end use being a study or feasibility evaluation and an expected accuracy range of -30 percent to +50 percent. As the project is better defined, the accuracy level of the estimates can be narrowed.

Since construction costs change periodically, an indexing method to adjust present estimates in the future is useful. The Engineering News-Record (ENR) Construction Cost Index (CCI) is a commonly used index for this purpose. For purposes of future cost estimate updating, the ENR CCI for Seattle, Washington for these estimates is 12,771.70 (September 2020).

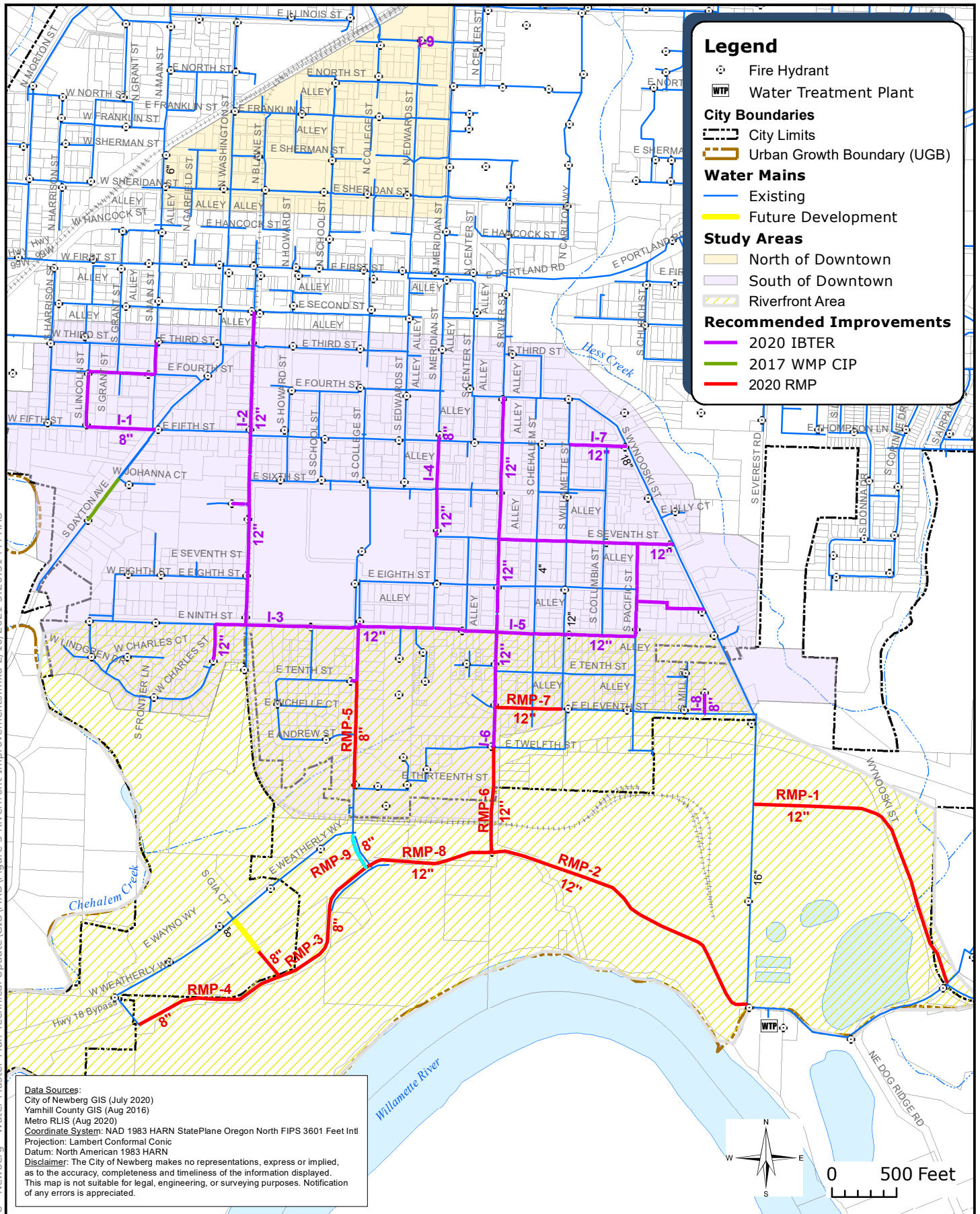
Table 8

Capital Improvement Program (CIP)

Improvement Category	Project No.	Project Title	CIP Cost Summary ¹				Purpose	
			5-year 2021 to 2026	5 to 10-year 2027 to 2031	10 to 20-year 2032 to 2041	20-year TOTAL		
Supply		2 mgd redundant supply development	\$ 3,915,000			\$ 3,915,000	Resilience	
		Seismic resilience - add emergency connection and controls at existing WTP	\$ 500,000			\$ 500,000	Resilience	
		Seismic resilience - existing WTP seismic upgrade		\$ 8,500,000		\$ 8,500,000	Resilience, replacement of existing, not SDC eligible	
<i>Supply Subtotal</i>			\$ 4,415,000	\$ 8,500,000	\$ -	\$ 12,915,000		
Storage Reservoirs		Seismic resilience - North Valley Reservoirs hydraulic control valves and site piping improvements		\$ 1,050,000		\$ 1,050,000	Resilience, replacement of existing, not SDC eligible	
<i>Storage Subtotal</i>			\$ -	\$ 1,050,000	\$ -	\$ 1,050,000		
Pump Stations	P-1	Bell East Pump Station - Zone 3 constant pressure	\$ 2,605,000			\$ 2,605,000	Growth, Reliability	
	P-2	Bell West Pump Station - Zone 2 constant pressure; mains Bell West P.S. to Veritas School M-14, M-15	\$ 2,017,104			\$ 2,017,104	Growth, Reliability	
<i>Pump Stations Subtotal</i>			\$ 4,622,104	\$ -	\$ -	\$ 4,622,104		
Distribution Mains ³	M-1 thru 5, M-7, 8, 18	Upsize existing mains and construct new distribution loops to improve fire flow capacity	\$ 2,085,000	\$ 901,000		\$ 2,986,000	Improve level of service - Zone 1	
	M-9	NE Zimri Drive Zone 3 distribution backbone within UGB	\$ 413,000			\$ 413,000	Growth, reliability - Zone 2 and 3	
	M-19	Chehalem Drive water system extension north to Columbia Drive		\$ 721,000		\$ 721,000	Service area extension	
	M-20	ODOT 219/N College Street - waterline relocation and valves	\$ 568,000			\$ 568,000	ODOT requirement/system maintenance	
	<i>IBTER Fire Flow improvements for increased housing density</i>						\$ 6,615,000	
	I-1	Upsize existing 6-inch mains to 8-inch mains on S Main, S Lincoln, W 4th, W 5th Streets			\$ 624,000	\$ 624,000	Growth, upsize existing	
	I-2	Upsize existing 4- and 6-inch mains to 12-inch mains on S Blaine Street		\$ 1,152,000		\$ 1,152,000	Growth, upsize existing	
	I-3a	Upsize existing 6-inch main to 8-inch main in S College Street north of E 9th Street		\$ 11,000		\$ 11,000	Growth, upsize existing	
	I-3b	Upsize existing 6-inch mains to 12-inch mains in E 9th Street, Charles Street, and S College Street		\$ 1,321,000		\$ 1,321,000	Growth, upsize existing	
	I-4a	Upsize existing 6-inch main to 8-inch main in S Meridian Street north of E 5th Street			\$ 16,000	\$ 16,000	Growth, upsize existing	
	I-4b	Upsize existing 6-inch main to 12-inch main in S Meridian Street			\$ 329,000	\$ 329,000	Growth, upsize existing	
	I-5	Upsize existing 4- and 6-inch mains to 12-inch mains in E 7th Street, S Pacific Street, E 9th Street, and Paradise Drive	\$ 1,662,000			\$ 1,662,000	Growth, upsize existing	
	I-6	Upsize existing 6-inch mains to 12-inch mains in S River Street (north of the by-pass)		\$ 1,232,000		\$ 1,232,000	Growth, upsize existing	
	I-7	Upsize existing 6-inch mains to 12-inch mains in E 5th Street			\$ 204,000	\$ 204,000	Growth, upsize existing	
	I-8	Upsize existing 6-inch main to 8-inch main from E 11th Street to the Boston Square Apartments			\$ 58,000	\$ 58,000	Growth, upsize existing	
	I-9	Upsize existing 6-inch main to 8-inch main in Vermillion Street			\$ 6,000	\$ 6,000	Growth, upsize existing	
	<i>RMP Riverfront area improvements</i>						\$ 4,564,000	
	RMP-1 thru 4, 8, & 9	New water mains to serve future development in Riverfront area		\$ 1,831,000	\$ 1,831,000	\$ 3,662,000	Growth, Zone 1 not currently served	
	RMP-5	Upsize existing 6-inch S College St main to 8-inch main to serve future Riverfront development		\$ 301,000		\$ 301,000	Growth, upsize existing	
	RMP-6, 7	Upsize existing 6-inch River and 11th St mains to 12-inch mains to serve future Riverfront development (south of the by-pass)		\$ 601,000		\$ 601,000	Growth, upsize existing	
	Seismic resilience - cast iron and concrete pipe replacement		\$ 500,000	\$ 1,000,000	\$ 1,500,000	Resilience		
	Routine Main Replacement Program	\$ 875,500	\$ 1,000,000	\$ 2,000,000	\$ 3,875,500	Asset renewal, reliability		
<i>Distribution Mains Subtotal</i>			\$ 5,603,500	\$ 9,571,000	\$ 6,068,000	\$ 21,242,500		
Future High Elevation Water Infrastructure	R-1	1.7 MG Bell Road Reservoir - Zone 3			\$ 2,886,000	\$ 2,886,000	Growth, reliability	
	M-16	Zimri Drive East transmission main to Bell Road Reservoir			\$ 3,078,000	\$ 3,078,000	Growth, reliability	
	M-17	Bell Road west transmission main - N College Street to Zimri Drive			\$ 2,678,000	\$ 2,678,000	Growth, reliability	
<i>Zone 2, 3, 4 Infrastructure Subtotal</i>			\$ -	\$ -	\$ 8,642,000	\$ 8,642,000		
Planning		Water Management & Conservation Plan update		\$ 150,000		\$ 150,000	Requirement	
		Water Master Plan update			\$ 300,000	\$ 300,000	Requirement	
		AWIA Risk & Resilience Assessment	\$ 103,000			\$ 103,000	Requirement	
	<i>Seismic resilience planning</i>							
		Develop new engineering standards		\$ 50,000		\$ 50,000	Resilience	
		Additional geotechnical investigations to define geohazards		\$ 75,000		\$ 75,000	Resilience	
		Investigate specific structural recommendations at existing WTP and other City facilities		\$ 100,000		\$ 100,000	Resilience	
	Evaluate mitigation strategies for raw water pipeline bridge		\$ 75,000		\$ 75,000	Resilience		
<i>Planning Subtotal</i>			\$ 103,000	\$ 450,000	\$ 300,000	\$ 853,000		
Other		Fixed base automatic meter reading infrastructure (AMI)	\$ 453,998			\$ 453,998	Efficiency	
		North non-potable water line and Otis Springs pumping improvements		\$ 2,105,000		\$ 2,105,000	Non-potable system growth	
		Public Works Maintenance Facility Master Plan	\$ 844,145			\$ 844,145		
<i>Other Subtotal</i>			\$ 1,298,143	\$ 2,105,000	\$ -	\$ 3,403,143		
<i>CIP Total</i>			\$ 16,041,747	\$ 21,676,000	\$ 15,010,000	\$ 52,727,747		

Table 9
2017 WMP References

Technical Update memo page or reference	2017 WMP Report Section		Description
	Section or reference	Page	
Table 1	Table 2-1	2-3	Historical Water Demand Summary - add data through 2020
Table 2	Table 2-3	2-5	Future Water Demand Summary - update 2035 to 2041, add Riverfront
Table 3, Page 5 Riverfront	Table 2-4	2-6	Future Water Demand by Pressure Zone - update Zone 1, all Riverfront demand is in Zone 1
Table 4	Section 3	3-8	Criteria summary - add recommended fire flow for new Riverfront zoning designations
Page 10 Supply	Section 4	4-8	Treatment capacity summary text - update with projected 20-year demands and operational strategy to address deficiency
Page 10 Distribution System Analysis	Table 5-1 & 5-2	5-5	Storage and pumping analysis tables - update Zone 1 required capacity based on change in 20-year demand with Riverfront, no impact to capacity
Table 8	Table 7-5	7-15	CIP Table - replace with updated



**Water Master Plan
 Technical Update**

**Figure 2
 Riverfront (RMP) &
 Middle Housing (IBTER)
 CIP Projects**

Technical Memorandum

Date: October 30, 2020

Project: Newberg Water Master Plan (WMP) Technical Update

To: Brett Musick, P.E.
City of Newberg Engineering

From: Heidi Springer, P.E.
MurraySmith

Re: Water system analysis results to inform Infrastructure Based Time Extension Request (IBTER) for Oregon House Bill 2001 (HB 2001) Missing Middle Housing

This project is funded by Oregon general fund dollars through the Department of Land Conservation and Development. The contents of this document do not necessarily reflect the views or policies of the State of Oregon.

Introduction and Purpose

This memo documents an analysis of the estimated impact of increased residential housing density on water system infrastructure in two areas of the City of Newberg (City). Increased housing density is anticipated as result of 2019 Oregon legislation, House Bill (HB) 2001 Missing Middle Housing, which requires updates to local laws throughout Oregon that currently limit the types of housing approved for construction in residentially zoned areas. The City will adopt regulations that will allow for the development of duplexes and other types of middle housing in areas zoned for residential development to comply with this legislation and address needed housing types for residents at all income levels.

This analysis was conducted to inform an Infrastructure-Based Time Extension Request (IBTER) as described in Oregon Administrative Rules (OARs) 660-046-0300 to 0370 which became effective August 7, 2020. An approved IBTER would grant the City additional time to comply with the requirements of HB 2001 Missing Middle Housing.

IBTER Study Areas

City staff identified two areas for infrastructure analysis to inform an IBTER:

- North of Downtown Newberg - up to the rail line that runs through Newberg to Hess Creek (**Figure 1**)
- South of Downtown Newberg - from the Chehalem Creek and railroad line intersection to the WestRock line and Hess Creek (**Figure 2**)

Water System Background

The existing Newberg water system is served almost entirely as a single pressure zone, Zone 1. Both IBTER study areas are in Zone 1. Zone 1 customers receive pressure from three finished water storage reservoirs, North Valley Reservoirs 1 and 2 north of downtown and Corral Creek Reservoir east of downtown. These reservoirs are filled through the distribution system pipe network by pumps at the City's Water Treatment Plant on the Willamette River near the former WestRock mill site. The WTP is supplied by the City's wellfield on the south side of the Willamette River across from the WTP.

In general, the City's distribution system runs at relatively high pressures with most customers receiving near 80 pounds per square inch (psi), which is the Oregon Plumbing Code service pressure maximum.

The City adopted the current Water Master Plan (WMP) in 2017. The current WMP identifies a single distribution main capital improvement program (CIP) project within the IBTER south study area, replacement of a 4-inch diameter main on Dayton Avenue to meet fire flow criteria (WMP CIP M-2).

Water System Hydraulic Analysis

Consistent with IBTER state guidelines, the following analysis considers fire flow availability and service pressure impacts, if any, resulting from increased density within the IBTER study areas. Required fire flow by land use type and acceptable service pressure ranges in the distribution system are as established in the 2017 WMP and summarized in the following paragraphs.

IBTER guidelines specify that only localized utility impacts, not system-wide impacts, should be evaluated in support of an IBTER, thus a Zone 1 storage and system-wide supply analysis are not examined in detail. In general, the City's existing Zone 1 storage and supply facilities have adequate surplus capacity, therefore a short-term storage or supply impact is not expected from increased density in these limited areas. Impacts to the distribution system piping to meet fire

flow and pressure criteria are understood to be only those improvements needed beyond what was recommended in the 2017 WMP, WMP CIP M-2.

A distribution system analysis was conducted using a steady-state hydraulic network analysis model developed and calibrated with field flow testing data for the 2017 WMP.

Water Demand

Water demands can be estimated using either water consumption billed to customers or finished water production recorded at the WTP. For planning purposes, water consumption from billing records is used to assign water use geographically throughout the water system model based on service address. However, water consumption data does not capture non-revenue water, such as minor leaks and maintenance uses like hydrant flushing for water quality. To account for non-revenue water uses, distributed demands by customer service address are scaled up in the model to match water produced by the WTP. This approach effectively distributes non-revenue water evenly throughout the distribution system.

Water Demand Metrics

Water demand is described using two metrics:

- Average Daily Demand (ADD) – the total water production for a given year divided by 365 days
- Maximum Day Demand (MDD) – the largest calendar day (24 hours) water production for a given year; in Newberg and western Oregon, maximum day demand occurs between July 1 and September 30th each year (this is referred to as the peak season)

Demand per Dwelling Unit

In systems with primarily residential demands like Newberg, it can be useful to estimate a demand per person per day measured in gallons per capita day (gpcd). This is estimated as system-wide ADD divided by the water service area population. This per capita demand implicitly includes all non-residential water system demands and can be used to forecast future water demands based on population growth or new residential unit construction. **Table 1** summarizes estimated demand per dwelling unit based on historical WTP production records, Newberg population estimates from the Portland State University Population Research Center (PSU PRC), and a 2.66 average number of persons per dwelling unit from US Census data. MDD is approximately two times ADD, consistent with the 2017 WMP.

Table 1
Average Water Demand per Dwelling Unit

Year	ADD (mgd)	Population	ADD/person (gpcd)	ADD/unit (gpd)	MDD/unit (gpd)
2016	2.35	23,465	100	266	532
2017	2.35	23,480	100	266	532
2018	2.39	23,795	101	269	538
2019	2.27	24,045	94	250	500
Average ADD and MDD per Unit in gallons per day (gpd)				263	526

Estimated Growth from Increased Density due to Middle Housing

Per state IBTER guidelines in OAR 660-046-0320 and 330, the City may consider a one percent growth rate for infill development in the IBTER study areas. The City may consider a three percent growth rate for any properties considered un- or underdeveloped. Underdeveloped is defined in the OARs as a larger than one-half acre parcel zoned for detached single-family housing which has an existing density of less than or equal to two units per acre.

City Planning staff provided detailed parcel information for each area and identified parcels which may be considered underdeveloped. Estimated growth in dwelling units for the IBTER study areas based on this parcel data and the OAR guidelines is summarized in **Table 2**.

Table 2
Estimated Dwelling Unit Growth

IBTER Area	Existing Units			Infll Growth Units	Redevelopment Growth Units
	Developed Parcels	Underdeveloped Parcels	TOTAL Existing Units	(1% for existing developed)	(3% for existing underdeveloped)
South of Newberg	1,485	36	1,521	18	3
Single Family	879	35	914	9	2
Multi Family	428	-	428	5	-
Duplex	125	1	126	2	1
Triplex	21	-	21	1	-
Fourplex	32	-	32	1	-
North of Newberg	176	-	176	3	-
Single Family	170	-	170	2	-
Multi Family	-	-	-	-	-
Duplex	6	-	6	1	-
TOTAL Existing Units			1,697	TOTAL Growth	24

Estimated Study Area Demand

Current demand and estimated demand with middle housing growth for the IBTER study areas is summarized in **Table 3**. Current ADD was estimated based on geographic assignment of 2015 billing records in the hydraulic model for the 2017 WMP and 2019 City WTP production. As shown in **Table 1**, ADD has remained relatively constant since 2016.

Table 3
IBTER Study Area Demand Summary

Area	Current Demand (gpd)		Estimated Demand with middle housing growth (gpd)	
	ADD	MDD	ADD	MDD
South of Downtown	336,240	672,480	341,763	683,526
North of Downtown	52,070	104,141	52,859	105,719

Distribution System Performance Criteria

System performance was evaluated using pressure, pipe velocity, and required fire flow criteria established in the 2017 WMP and summarized in **Table 4**.

Table 4
Distribution Performance Criteria

Water System Component	Evaluation Criterion	2017 WMP Value	Design Standard/Guideline
Service Pressure	Normal Range, during ADD	40-80 psi	City's 2015 Public Works <i>Design and Construction Standards</i>
	Maximum, without PRV	80 psi	Oregon Plumbing Specialty Code 608.2
	Minimum, during emergency or fire flow	20 psi	OAR 333-061
Distribution Mains	Velocity during fire flow	Not to exceed 8 fps	City's 2015 Public Works <i>Design and Construction Standards</i>
	Velocity during ADD	Not to exceed 5 fps	
Required Fire Flow and Duration	Low Density – Single-Family and Duplex Residential <= 3,600 sq ft	1,000 gpm for 2 hours	Oregon Fire Code
	Single-Family and Duplex Residential >3,600 sq ft	1,500 gpm for 2 hours	
	Medium Density Residential	1,500 gpm for 2 hours	
	High Density Residential	2,000 gpm for 3 hours	
	Commercial	3,000 gpm for 3 hours	
	Industrial, Institutional, and Hospitality	4,500 gpm for 3 hours	

Assumptions and Modeling Conditions

For the purposes of this analysis, it is assumed that all Zone 1 reservoirs are operating approximately three-quarters full and the WTP is not actively pumping to fill storage reservoirs.

Analysis Findings and Distribution System Constraints

Service Pressure

Modeled main line pressures under MDD conditions in the IBTER south area are between approximately 90 and 100 psi. Pressures in the north study area range between approximately 80 and 90 psi. These mainline pressure ranges remain the same with the approximately two percent increase in water demand generated by potential middle housing increased density.

Fire Flow Availability

Fire flow availability was tested at 2,000 gallons per minute (gpm) consistent with high density residential required fire flow from **Table 4**. This 2,000 gpm fire flow may be conservative in some parts of the IBTER study areas where smaller structures with fewer units, like duplexes, are more likely to be developed. However, providing water infrastructure capable of supplying a 2,000 gpm fire flow allows the City to consider a broader range of middle housing options as HB 2001 zoning changes are evaluated.

Fire flow availability in the south IBTER study area is constrained by high pipe flow velocity. Adequate pressure is available to supply fire flow and maintain service pressures above 20 psi for public health. However, small diameter 4- and 6-inch diameter pipe grids in the south study area create flow velocities over 20 feet per second (fps) during a fire flow event. Fire flow in the north study area is less constrained with 8-inch diameter well looped existing mains interconnected with the 18-inch diameter North Valley Reservoirs transmission main.

The primary concern with high pipe velocity is abrasion of the interior pipe coating, which can expose the pipe material to corrosion and lead to potential pipe failure. This is generally a greater concern when high flow velocity extends over a long period of time as part of normal system operation. In the case of a fire flow event, these high flow velocities are both infrequent and for a short time when they do occur. Thus, a pipe velocity higher than the 8 fps specified in **Table 4** may be acceptable, provided there is adequate available pressure to supply fire flow as is the case in Newberg's IBTER south study area. According to information from the Ductile Iron Pipe Research Association (DIPRA), 14 fps is a conservative maximum pipe velocity based on satisfactory historical performance of cement mortar lined ductile iron pipe. For the purposes of this analysis available fire flow is evaluated at a flow velocity of 14 fps.

Figure 3 at the end of this memo illustrates available fire flow in the north and south IBTER study areas with existing water mains under max day demand conditions and with a maximum flow velocity of 14 fps.

Recommended Improvements

Eight significant pipe improvement projects are recommended for the south study area and one minor project is recommended for the north study area to provide adequate fire flows to potential higher density development. In the south, existing development is primarily served from a 4- and 6-inch diameter pipe grid. While a 6-inch diameter main can provide a 1,000 gpm single-family residential fire flow, a 6-inch diameter grid is inadequate to provide a 2,000 gpm multi-family residential fire flow.

Existing 6-inch diameter mains along key corridors in the south study area, including S College Street, S River Street, and E 9th Street, are recommended to be upsized to 12-inch diameter mains to provide a large diameter backbone for the area to meet 2,000 gpm fire flow requirements for potential higher density development. Additional looping is also recommended to connect larger diameter mains with the 18-inch diameter transmission main in Wynooski Street and for the W 4th Street neighborhood between Dayton Avenue and Hwy 99W.

Two areas in the southwest corner of the south study area cannot be supplied a 2,000 gpm fire flow without significant or total pipe replacement and upsizing. The first area is the S Charles Street loop, which is bordered by Chehalem Creek to the west making it difficult to connect to the water system outside of the south study area. The second area is between S College Street and S River Street just north of the Newberg Dundee Bypass, which does not have an existing east-west right-of-way to provide additional looping. Rather than replacing these pipes in their current alignments, it is instead recommended that the City assess fire flow to these areas and potential distribution system looping along with future transportation projects associated with the Riverfront area, such as the extension of S Blaine Street south of Ewing Young Park and the extension of a future road across the former WestRock mill property connecting the area around the City's WTP and NE Rogers Landing Road.

Figure 4 at the end of this memo illustrates recommended pipe improvement projects.

Cost Estimates

An estimated cost has been developed for each recommended piping improvement project. New piping is assumed to be ductile iron pipe installed by private contractors.

Cost estimates represent opinions of cost only, acknowledging that final costs of individual projects will vary depending on actual labor and material costs, market conditions for construction, regulatory factors, final project scope, project schedule and other factors. The Association for the Advancement of Cost Engineering International (AACE) classifies cost estimates depending on project definition, end usage, and other factors. The cost estimates presented here are considered Class 4 with an end use being a study or feasibility evaluation and an expected accuracy range of -30 percent to +50 percent. As the project is better defined, the accuracy level of the estimates can be narrowed.

Since construction costs change periodically, an indexing method to adjust present estimates in the future is useful. The Engineering News-Record (ENR) Construction Cost Index (CCI) is a commonly used index for this purpose. For purposes of future cost estimate updating, the current ENR CCI for Seattle, Washington is 12,771.70 (September 2020).

Recommended improvements and estimated costs are summarized in **Table 5**.

Table 5
Recommended Improvements

Project No.	Project Description	Estimated Project Cost ¹⁻⁶
I-1	Install 1,733 LF of 8-inch DI Pipe in S Main Street, W 4th Street, S Lincoln Street, and W 5th Street	\$624,000
I-2	Install 2,558 LF of 12-inch DI Pipe in S Blaine Street	\$1,152,000
I-3	Install 2,962 LF of 8- and 12-inch DI Pipe in E 9th Street, Charles Street, and S College Street	\$1,332,000
I-4	Install 772 LF of 8- and 12-inch DI Pipe in S Meridian Street	\$345,000
I-5	Install 3,691 LF of 12-inch DI Pipe in E 7th Street, S Pacific Street, E 9th Street, and Paradise Drive	\$1,662,000
I-6	Install 2,736 LF of 12-inch DI Pipe in S River Street	\$1,232,000
I-7	Install 453 LF of 12-inch DI Pipe in E 5th Street	\$204,000
I-8	Install 159 LF of 8-inch DI Pipe from E 11th Street to the Boston Square Apartments	\$58,000
I-9	Install 15 LF of 8-inch DI Pipe in Vermillion Street	\$6,000
Total Cost		\$6,615,000

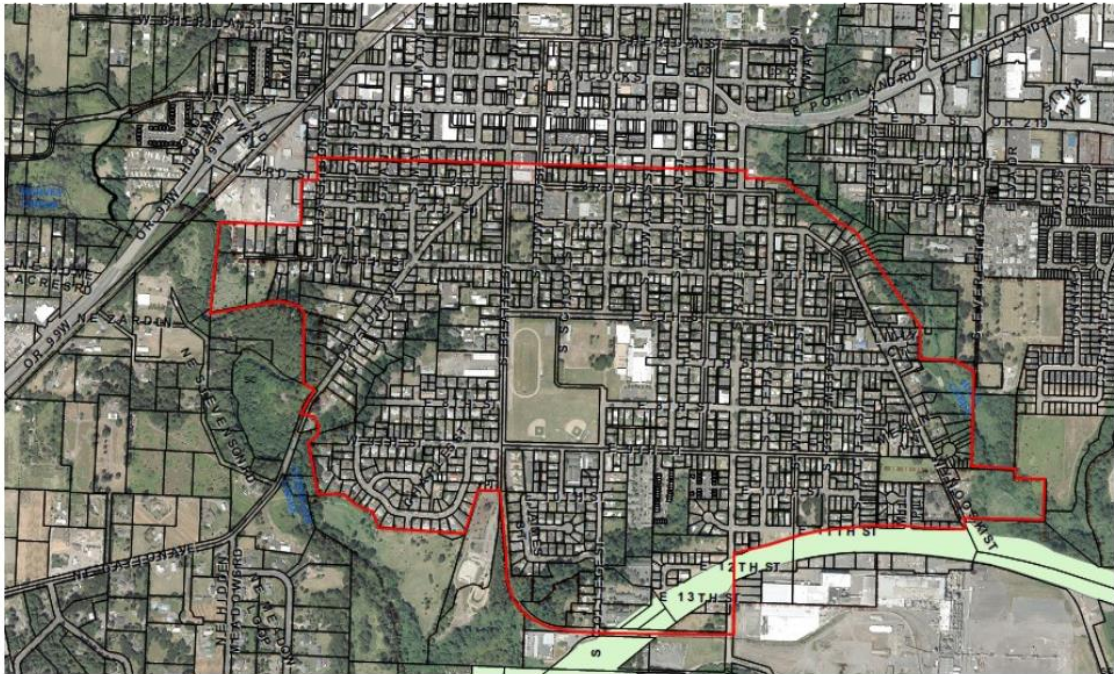
Notes:

1. All costs are in 2020 dollars
2. Includes costs for fittings/valves and connections to existing services and hydrants
3. Includes local street trench patch resurfacing; whole or half street overlays are not included
4. Includes an allowance of 30% for construction contingency, 25% for engineering, permitting and inspection, and 1% for Oregon Corporate Activity Tax (applied to construction costs only)
5. Easement and right-of-way costs are not included
6. City project management and administrative costs are not included

Figure 1: North of Downtown Newberg



Figure 2: South of Downtown Newberg



Memo

Date: Monday, July 20, 2020

Project: Seismic Resilience Assessment

To: Brett Musick, PE, City of Newberg

From: Andy McCaskill, P.E.; Katie Walker, P.E.

Subject: Executive Summary

Introduction

The City of Newberg (City) operates a water system consisting of a wellfield, raw water transmission pipelines, a water treatment plant, three water storage reservoirs, one pump station, and distribution system pipelines. In support of the 2017 Water Master Plan and Oregon Health Authority (OHA) guidelines, the City conducted a water system seismic resilience assessment (SRA). The purpose of the SRA is to define level-of-service (LOS) goals, evaluate the expected performance of the system during a Cascadia Subduction Zone (CSZ) earthquake, and identify recommended mitigation measures to address deficiencies. The SRA included the following studies:

- Seismic Resiliency Goals – during this study, goals and retrofit performance criteria were defined (see Appendix A).
- Geotechnical Engineering Report (GER) – during this study, geotechnical conditions were reviewed to identify seismic hazards (see Appendix B).
- Vulnerabilities Assessments – the purpose of this report was to assess the vulnerabilities of the City’s water system and the pipeline bridge (see Appendix C).
- Mitigation Recommendations – mitigation strategies were recommended and developed at a conceptual level to address some system vulnerabilities (see Appendix D).
- Recommendations for Future Studies – additional studies were identified to clarify and confirm the City’s seismic mitigation needs (see Appendix E).

This executive summary presents the purpose and key findings from each study.

Seismic Recovery Goals

In this study, the water system level of service goals were established to define performance expectations after a CSZ earthquake. A collaborative workshop was conducted to identify the restoration priorities for the City with short-term (no disruption) needs including fire suppression and the Providence Newberg Medical Center. Using guidelines in the Oregon Resilience Plan (ORP) tailored to the City’s needs, recovery goals were identified for all major components of the water system (see Attachment A).

The study also identified the backbone of the City’s water system, which are the components required to meet the short-term needs outlined in the recovery goals (see Attachment B). These

components should be designed or modified to experience only minor damage during a CSZ earthquake.

In addition to defining goals and identifying the system backbone, objectives for retrofitting existing water system components were identified based on how quickly they could be restored.

Geotechnical Engineering Report

The GER included a review of the existing geologic and geotechnical conditions to develop seismic ground motion, seismic hazard, and permanent ground deformation hazard maps. At the WTP, the following was conducted:

- One boring
- Evaluation of liquefaction potential and liquefaction-induced settlement
- Evaluation of potential for slope failure
- Evaluation of seismically induced ground movement and potential for lateral spread

Vulnerabilities Assessment

In the Vulnerabilities Assessments, water system components were compared against the seismic hazard maps developed in the GER showing peak ground velocity, probability of liquefaction, and landslide induced permanent ground deformation. In addition to a desktop review, a site visit was conducted to inspect the water system and interview City personnel. Based on the assessment, the following vulnerabilities were identified:

Pipeline Bridge

A desktop assessment was conducted to review the bridge, but record drawings were not available. The assessment concluded that the bridge and transmission main are unlikely to survive a CSZ earthquake. A retrofit, likely costing in the tens-of-millions, would be required with additional studies and inspections needed to clarify and confirm the bridge conditions.

Wellfield

In general, the wells are likely at risk for liquefaction and lateral spread. During a CSZ earthquake, differential settlement could occur between the well casing and pipe connection, the well screen could be plugged, and the seismic shaking could cause groundwater levels to fluctuate. Additional vulnerabilities include lack of backup power and lack of reliable access across the river.

30-inch HDPE Transmission Main

Based on a review of the geotechnical documents from the construction of the main, the transmission main is susceptible to liquefaction induced settlement on the southern side of the river, and at the shallowest section on the northern side of the river. These conditions would likely result in differential settlement causing pipe separation or damage during a CSZ earthquake.

Water Treatment Plant

Studies conducted at the WTP indicate up to two feet of lateral spread displacements at a distance of approximately 300 feet from the crest of the slope during a CSZ earthquake. Stability analyses also showed seismically induced ground displacements in the range of approximately 7.5 feet. In addition, the review of the slope indicated that it is only marginally stable under static conditions and not stable in seismic or post-seismic conditions.

A site visit was conducted to assess components at the WTP. In general, the review of the structures indicated that none meet either the structural or non-structural performance objectives outlined as part of the Seismic Recovery Goals. Significant work is required at the WTP to meet recovery goals, and it was recommended that further evaluation be conducted to compare the cost of upgrading the WTP versus building a new WTP. However, it should be noted that while the buildings will not withstand a CSZ event, the plant site itself is not susceptible to a landslide into the river.

Water System Backbone

The seismic hazard maps prepared under the GER were applied against pipeline information, such as age, corrosion, and material, to identify the estimated number of pipeline breaks and length of repair. For the non-landslide areas, it is estimated that 245 breaks will occur (see Attachment C, Table 1). For the landslide prone areas, a range of 84 to 626 breaks will occur (see Attachment C, Table 2).

Water Distribution Pipelines

The water distribution network is considered a lower priority for seismic resilience based on the LOS goals established by the City. For the non-landslide areas, it is estimated that 1,159 water breaks will occur (see Attachment C, Table 3). For the landslide prone areas, a range of 336 to 2,518 breaks will occur (see Attachment C, Table 4).

WTP Yard Piping

Several vulnerabilities exist at the WTP including:

- Lack of isolation valves at the WTP to prevent water loss or cross contamination, or preserve water storage at the WTP
- Lack of a WTP bypass line to supply water from the wellfield to the distribution for firefighting or domestic use (boiling required for potable use)
- Lack of seismic couplings at building pipeline penetrations to prevent pipe separation

Water Storage Tanks Yard Piping

Vulnerabilities at the Corral Creek Site include:

- Flexible couplings may need to be replaced with seismic couplings to provide more movement during an earthquake
- Lack of seismic couplings on the pipeline to prevent pipe separation
- Lack of a hydraulic control valve to quickly protect water storage if a loss of power or SCADA occurs

Vulnerabilities at the North Valley Water Storage Tanks include:

- Unknown capabilities of couplings at pipe penetrations
- Inlet/outlet line will be subject to landslide movements and pipeline separation
- Lack of a hydraulic control valve to quickly protect water storage if a loss of power or SCADA occurs

Water System Operations

Vulnerabilities and observations related to water system operations include:

- No fire flow or pressure deficiencies were identified that could affect system recovery after a CSZ earthquake
- No deficiencies in water system storage capacity
- SCADA system could be improved or expanded to include greater centralized monitoring and control of the system, with backup power and communications improved at identified locations
- Lack of a redundant water supply, which is currently being investigated under another study
- Ensure GIS mapping is adequately detailed to locate critical isolation valves and facilities in an emergency.

Mitigation Recommendations

The Vulnerabilities Assessment identified areas where the City needs to improve or retrofit the water system. The following five mitigation strategies were identified as top priorities for the City. Mitigation strategies were presented in two separate memos: one for recommendations at the WTP and one for recommendations within the distribution and storage system.

Rehabilitation of Existing WTP

The existing WTP is susceptible to liquefaction, ground deformation, and lateral spreading. The goal of rehabilitation is to address the deficiencies identified in previous studies by installing ground improvements between the WTP site and the shoreline to prevent lateral movement and strengthening structural components to withstand a CSZ event. The range of construction cost estimates could be from \$3.3M to \$13M.

Construction of Greenfield WTP

Since several structures at the existing WTP are nearing the end of their useful life, an alternative strategy is to replace the existing plant with a seismically resilient one. The range of construction cost for a new plant could be from \$12.3M to \$49.2M.

Emergency Connection and Control at the WTP

As identified in the vulnerability assessment, the WTP poses several risks if a CSZ earthquake occurs. By adding a point for emergency cross-connection and installing hydraulic control valves, the plant could be isolated during an earthquake event, allowing raw water to continue

into the distribution system. The construction cost for these improvements is approximately \$500K.

Improvements to Water Storage

The vulnerability assessment identified the potential for water loss at the storage tanks during a CSZ earthquake. By adding hydraulic control valves and replacing a portion of the pipe at North Valley Water Storage Tanks, water storage at the tanks could be preserved. The construction for the improvements at the Corral Creek Site is approximately \$300K, and \$750K at the North Valley Water Storage Tanks.

Cast Iron and Concrete Pipe Replacement

Based on the evaluation of pipeline in the City's backbone, old cast iron and concrete pipe poses the greatest risk for damage during a CSZ earthquake. The construction costs for the replacement of pipe is approximately \$12.5M and represents the replacement of more than 37,000 linear feet of pipe.

Recommendations for Future Studies

To further refine mitigation strategies, additional studies are required. Studies recommended include the following list (Note that this list is not all-inclusive as other efforts will likely be identified):

- Develop new engineering standards to address seismic resiliency needs in new infrastructure or buildings
- Identification of alternative water demands that could impact water storage available within the system
- Additional geotechnical investigations to better classify the seismic hazards that the water system may experience and allow the City to focus on the most hazardous areas.
- Investigate specific structural recommendations for structures at the WTP and other City facilities
- Evaluate specific mitigation strategies for the pipeline bridge
- Investigate additional mitigation strategies that address remaining vulnerabilities



Attachment A:
Water System Recovery Goals



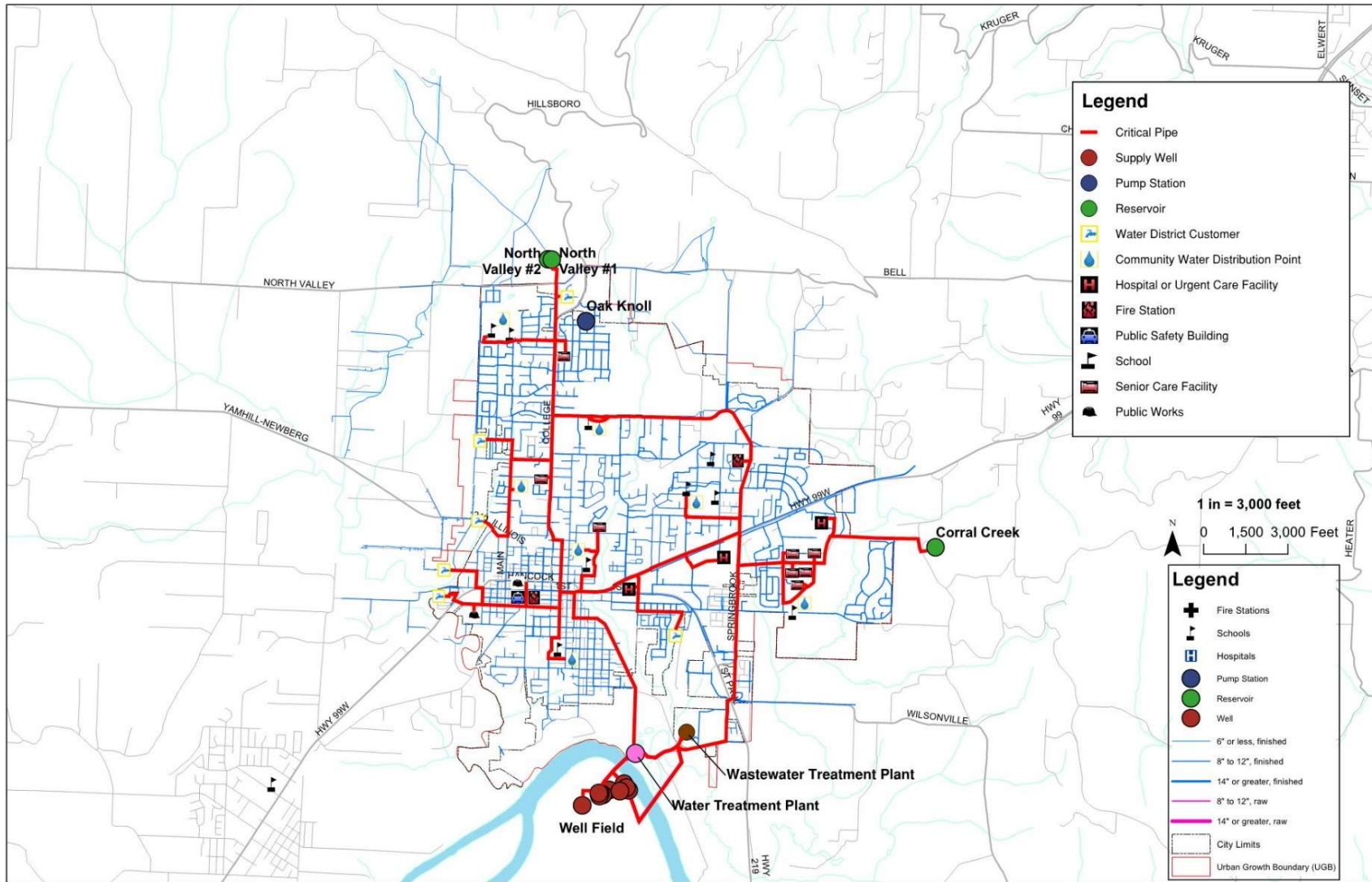
City of Newberg Water System Recovery Goals
(adapted from OSSPAC 2013 and NIST 2015)

Water Systems	Target Timeframe for Recovery							
	Phase 1: Short-Term			Phase 2: Intermediate			Phase 3: Long-Term	
	Days			Weeks			Months	
	0-1	1-3	3-7	1-2	2-4	4-12	3-6	6-12
Source								
Raw or source water and terminal reservoirs	R	Y		G				
Raw water conveyance (pump stations and piping to WTP)	R	Y		G				
Water Production	R	Y		G				
Well and/or Treatment operations functional	R	Y		G				
Transmission (including Booster Stations)								
Backbone transmission facilities (pipelines, pump station, and tanks)	G							
Water for fire suppression at key supply points (to promote redundancy)	G							
Control Systems								
SCADA and other control systems	G							
Distribution								
Critical Facilities								
Wholesale Users (other communities, rural water districts)	G							
Hospitals	G							
EOC, Police Stations, Fire Stations, Public Works Buildings	Y	G						
Emergency Housing								
Emergency Shelters	Y	G						
Housing/Neighborhoods								
Potable water available at community distribution centers		Y	G					
Water for fire suppression at fire hydrants			R	Y	G			
Community Recovery Infrastructure								
All other clusters			R	Y	G			

Key to Table
 Desired time to restore components to 30% operational R
 Desired time to restore components to 60% operational Y
 Desired time to restore components to 90% operational G



Attachment B:
Water System Backbone Map





Attachment C:
Water System Summary Tables



Table 1. Water System Backbone Summary, Non-Landslide Areas

Pipe Material	Total Material Length Within Geo-Hazard (ft)	Percentage of Backbone Total	Est. Total No. of Breaks	Est. No. of Breaks per 1,000 ft.	Est. Space Between Breaks (ft)
Cast Iron	23,860	25%	89	4	268
Ductile Iron	58,433	62%	109	2	536
RCC	12,592	13%	47	4	268
Grand Total	94,884	100%	245	3	387

Table note: Estimated Number of Breaks Due to peak ground velocity (PGV) and peak ground deformation (PGD) (non-landslide) by Pipe Material

Table 2. Water System Backbone Summary, Landslide Areas

Pipe Material	Total Material Length Within Geo-Hazard(ft.)	Percentage of Backbone Total	Est. Total No. of Breaks	Est. No. of Breaks per 1,000 ft.	Est. Space Between Breaks (ft.)
Cast Iron	1,193	1%	30-228	25-191	5-39
Ductile Iron	2,922	3%	37-279	13-95	10-79
RCC	630	1%	16-120	25-191	5-39
Grand Total	4,744	5%	84-626	64-477	5-79

Table note: Estimated Number of Breaks Due to PGD (landslide) by Pipe Material

Table 3. Water Distribution System Summary, Non-Landslide Areas

Pipe Material	Total Material Length Within Geo-Hazard (ft)	Percentage of Distribution Total	Est. Total No. of Breaks	Est. No. of Breaks per 1,000 ft.	Est. Space Between Breaks (ft)
C-900	11,713	3%	35	3	336
CI	106,470	23%	397	4	268
DI	296,271	63%	553	2	536
PVC	28,707	6%	85	3	336
Other	23,905	5%	89	4	268
Grand Total	467,065	100%	1,159	2	403

Table note: Estimated Number of Breaks Due to PGV and PGD (non-landslide) by Pipe Material

Table 4. Water Distribution System Summary, Landslide Areas

Pipe Material	Total Material Length Within Geo-Hazard(ft.)	Percentage of Distribution Total	Est. Total No. of Breaks	Est. No. of Breaks per 1,000 ft.	Est. Space Between Breaks (ft.)
C-900	586	3%	12-89	20-153	7-49
CI	5,324	23%	135-1,016	25-191	5-39
DI	14,814	63%	188-1,413	13-95	10-79
PVC	1,435	6%	29-219	20-153	7-49
Other	1,195	5%	30-228	25-191	5-39
Grand Total	23,353	100%	336-2,518	59-439	5-79

Table note: Estimated Number of Breaks Due to PGD (landslide) by Pipe Material



Appendix A: Seismic Resiliency Goals



WATER SYSTEM SEISMIC RESILIENCE STUDY

**CITY OF NEWBERG PUBLIC WORKS DEPARTMENT
NEWBERG, OREGON**

Final Technical Memorandum: Seismic Recovery Goals

August 16th, 2019

SEFT Project Number: B19009.00

Table of Contents

List of Figures	ii
List of Tables.....	iii
1.0 Introduction and Background	1
1.1 City of Newberg Water System Description	1
1.2 Seismic Resilience Study.....	1
1.3 Resilience Planning by Other Metro Region Agencies.....	2
2.0 Community Resilience.....	3
2.1 Definition	4
2.2 Planning Process	4
2.3 Seismic Hazard	4
3.0 Level of Service Goals	8
3.1 SPUR Resilient City	8
3.2 Oregon Resilience Plan	8
3.3 NIST Community Resilience Planning Guide.....	10
3.4 San Francisco Public Utilities Commission	11
3.5 Community Needs Following a Major Earthquake	12
3.6 Water Supply Points for Fire Suppression	14
3.7 Community Water Distribution Points.....	14
3.8 City of Newberg Water System Level of Service Goals	16
4.0 City of Newberg Backbone System Supporting Short-Term Community Needs.....	18
5.0 Translation of Level of Service Goals into System Performance Requirements	20
5.1 Considerations	20
5.1.1 Geotechnical Hazards.....	20
5.1.2 Effects of Aftershocks	20
5.1.3 Repair Difficulty.....	20
5.1.4 Availability of Public Works Department Staff	21
5.1.5 Availability of Design Professionals and Contractors	21
5.1.6 Availability of Repair Materials or Replacement Equipment.....	21
5.1.7 Infrastructure Dependencies	21
5.2 Water System Structures	23
6.0 Limitations	28
References	29

List of Figures

Figure 2.1 – Six-Step Process to Planning for Community Resilience.....	6
Figure 2.2 – Oregon and Northern Japan Mirror Image Subduction Zones	7
Figure 2.3 – Historic Cascadia Subduction Zone Earthquake Timeline	7
Figure 3.1 – Potential Water Supply Points for Fire Suppression	15
Figure 3.2 – Potential Community Water Distribution Points	15
Figure 4.1 – City of Newberg Water System Backbone	19

List of Tables

Table 3.1 – ORP Water System Recovery Goals: Valley Zone	10
Table 3.2 – City of Newberg Social/Economic Recovery Goals.....	13
Table 3.3 – City of Newberg Water System Recovery Goals.....	17

1.0 Introduction and Background

1.1 City of Newberg Water System Description

The City of Newberg water system currently consists of the City's wellfield, raw water transmission pipelines, water treatment plant, three water storage reservoirs, one pump station, and distribution system pipelines. The entire water service area is one pressure zone, except for approximately 40 customers that are served by the Oak Knoll booster pump station. The system uses approximately 56 miles of distribution pipelines to provide water to business and residential customers within the City of Newberg service area and six small water district wholesale customers. The primary water supply is the City's well field located on the south side of the Willamette River in Marion County. Two raw water transmission mains cross the river to the treatment plant. An under river 30-inch diameter high density polyethylene transmission main can supply 100% of the treatment plant capacity. An older 24-inch diameter cast iron transmission main is supported by a decommissioned highway bridge. The City's water treatment plant is a conventional filtration facility with a nominal capacity of 9 million gallons per day (MGD). The current average day demand for the water system is approximately 2.4 MGD and summertime demands can increase to approximately 4.5 MGD.

1.2 Seismic Resilience Study

Based on recommendations contained in the 2017 City of Newberg Water Master Plan and requirements of the Oregon Health Authority, the City of Newberg is conducting a water system seismic resilience study. This study will evaluate the expected performance of the City water system following a Magnitude 9.0 (M9.0) Cascadia Subduction Zone (CSZ) earthquake and identify preliminary recommendations for improvements that should be implemented to enable the City to more rapidly restore water service after a major earthquake, to meet community social and economic needs. The scope of this seismic resilience study includes:

1. Define water system level of service (LOS) goals for the City water system following a major seismic event;
2. Identify key backbone system components that are required to achieve these LOS goals, including the locations of key supply points for water for fire suppression and community water distribution;
3. Define performance criteria for individual system components that are required to achieve these LOS goals;
4. Conduct a limited geotechnical seismic hazards evaluation for the City water system and slope stability analysis at the water treatment plant site (Shannon & Wilson);
5. Conduct a limited well/pipeline (HDR), and structural/nonstructural (SEFT/HDR) vulnerability assessment to determine estimated system performance following a M9.0 CSZ earthquake;

6. Identify gaps between the LOS goals and current performance estimates; and
7. Develop preliminary mitigation recommendations to close these gaps utilizing new or retrofit infrastructure, changes to design standards, enhancements in emergency response planning, and recommendations for further study.

This Technical Memorandum (TM) presents the HDR team recommendations related to scope items 1 through 3.

1.3 Resilience Planning by Other Metro Region Agencies

The resilience planning effort being undertaken by the City of Newberg is similar to the planning activities undertaken by several Portland metro region agencies. Additionally, numerous other agencies on the west coast of the United States and Canada are actively conducting resilience planning and resilience-based capital improvement projects.

Tualatin Valley Water District, City of Hillsboro Water Department, and Willamette Water Supply Program

TVWD and the City of Hillsboro Water Department have each completed a water system resilience plan and they are partnering to complete the billion-dollar Willamette Water Supply Program (WWSP) to provide an additional water supply for the region. When complete, the WWSP will greatly enhance the ability of the partner agencies to deliver water to their customers immediately after a major earthquake by providing a resilient and reliable water supply for the region, designed to meet stringent seismic performance goals.

City of Portland

The Portland Water Bureau has completed a water system resilience planning project and is beginning to incorporate recommendations from the plan into their capital improvement projects. The Bureau of Environmental Services has completed a wastewater system seismic resilience master plan and has already begun to incorporate early action item recommendations into practice.

City of Gresham

The City of Gresham has completed resilience planning projects for both their water and wastewater systems and are beginning to incorporate recommendations from these plans into their capital improvement projects. They have successfully leveraged their water system resilience plan to obtain Federal Emergency Management Agency pre-disaster mitigation grant funding to implement seismic improvements at one of their water reservoirs.

2.0 Community Resilience

Events like Hurricane Katrina in 2005, the Great East Japan M9.0 Earthquake and Tsunami in 2011, and Hurricane Sandy in 2012 have underscored the devastating impacts that natural disasters can inflict at a local, regional, state, and multi-state level. The Federal government has defined the National Preparedness Goal as: “A secure and resilient Nation with the capabilities required across the whole community to prevent, protect against, mitigate, respond to, and recover from the threats and hazards that pose the greatest risk” (FEMA, 2015).

One strategy to achieve this National Preparedness Goal is to plan for and implement programs and strategies to improve disaster resilience at the local, regional, state, and national level. Oregon is a national leader in community resilience. In February of 2013, the Oregon Seismic Safety Policy Advisory Commission submitted a report to the 77th Legislative Assembly entitled the *Oregon Resilience Plan: Reducing Risk and Improving Recovery for the Next Cascadia Earthquake and Tsunami* (OSSPAC, 2013). The report discussed the risk that is faced by the citizens of Oregon from an impending Cascadia Subduction Zone earthquake and accompanying tsunami, and the gaps that exist between the current state of Oregon’s infrastructure and where it needs to be. In addition to life safety impacts, the report also highlighted the economic vulnerabilities to individuals and communities from such an event. The *ORP* went on to outline steps that can be taken over the next 50 years to bring the state closer to resilient performance through a systematic program of vulnerability assessments, capital investments in public infrastructure, new incentives to engage the private sector, and policy changes that reflect current understanding of the Cascadia threat. While the *ORP* specifically addresses improving resilience in the aftermath of a major earthquake, implementation of the plan is also expected to improve resilience for other hazards.

A primary focus of the *ORP* goals is to minimize the long-term economic damage associated with the potential out-migration of businesses and population that would be expected to occur following a major disaster if basic services cannot be restored rapidly enough to meet the communities social and economic needs. Resilience of the water system will be key to the region’s economic recovery. For example, the fundamental goal of quickly restoring the supply of safe drinking water to homes and businesses will help to enable residents to shelter-in-place and businesses to resume operation as quickly as possible after the event. Small businesses are particularly vulnerable to being closed for an unplanned amount of time and many may not be able to re-open if closed for more than a month. Each business closing negatively impacts employment, tax revenue, and the long-term economic and social viability of the City. The more rapidly that businesses are able to reopen, the quicker revenue will normalize, and money will circulate within the region’s economy. At a fundamental level, the water system must be functioning at a certain level for service fees to be collected to provide revenue for the City of Newberg to sustain everyday functions and to help fund the recovery process.

2.1 Definition

In the field of community disaster planning, a common definition of “resilience” has been put forth by Presidential Policy Directive (PPD). PPD-8 [2011] defines resilience as “the ability to adapt to changing conditions and withstand and rapidly recover from disruption due to emergencies.” PPD-21 [2013] refined the definition to “...the ability to prepare for and adapt to changing conditions and to withstand and recover rapidly from disruptions. Resilience includes the ability to withstand and recover from deliberate attacks, accidents, or naturally occurring threats or incidents.”

2.2 Planning Process

While varied forms of community disaster preparedness planning have been taking place for decades, a specific focus on community resilience has developed over about the last 10 years. In 2015, the National Institute of Standards and Technology (NIST) published NIST Special Publication 1190, *Community Resilience Planning Guide for Buildings and Infrastructure Systems* (NIST, 2015). The *Guide* outlines a consistent framework for a six-step resilience planning process (see Figure 2.1) that is designed to be conducted at a community level, involving broad representation from local and regional government, building owners, infrastructure system owner/operators, and community representatives. The *Guide* process can also be adapted to resilience planning for a specific infrastructure system (e.g. water system), with some limitations. One of the main limitations of an individual infrastructure system planning approach is that it requires assumptions to be made that can’t be tested with community stakeholders and other infrastructure system providers. For instance, operation of water pump stations requires commercial electrical power or emergency generators with adequate fuel supplies. The timeline for restoration of commercial electrical power or availability of fuel for generators is largely controlled by stakeholders that aren’t involved in a water system only planning scenario.

2.3 Seismic Hazard

One of the initial steps in the resilience planning process involves determining the specific hazards to be safeguarded against. Consistent with Oregon Health Authority requirements, the City of Newberg has selected a M9.0 Cascadia Subduction Zone scenario earthquake as the hazard to be explicitly considered for this seismic resilience study.

The geologic and seismologic information available for identifying the potential seismicity throughout the State of Oregon is continually evolving, and large uncertainties are associated with estimates of the probable magnitude, location, and frequency of occurrence of earthquakes. The available information indicates the potential seismic sources that may affect the state can be grouped into three categories:

- Subduction zone events related to sudden slip between the upper surface of the Juan de Fuca plate and the lower surface of the North American plate,
- Subcrustal events related to deformation and volume changes within the subducted mass of the Juan de Fuca plate, and
- Local crustal events associated with movement on shallow, local faults.

A major contributor to the seismic hazard in western Oregon is the Cascadia Subduction Zone (CSZ) that lies off the coast of Oregon, Washington, Northern California, and British Columbia. The CSZ is an active plate boundary along which the remnants of the Farallon Plate (the Gorda, Juan de Fuca and Explorer plates) are being subducted beneath the western edge of the North American continent. Figure 2.2 shows that the subduction zone off the coast of Oregon is a mirror image of the subduction zone off the coast of Northern Japan that produced the deadly Magnitude 9.0 Tohoku earthquake in 2011. Seismologists anticipate that the strong shaking from a CSZ earthquake will last from 3 to 5 minutes, much longer than the 30-second strong shaking experienced in a typical California earthquake.

Seismologists' understanding of the damaging earthquakes produced by the CSZ has steadily increased over the past 25 years. Research by the Oregon Department of Geology and Mineral Industries (DOGAMI), Oregon State University, and others has provided evidence of the timeline of historic great CSZ earthquakes. The timeline of these 41 earthquakes over the last 10,000 years is provided in Figure 2.3, showing that past earthquakes have occurred at highly variable intervals, and can range widely in size and in which parts of the Pacific Northwest they affected. The rupture distance for these CSZ earthquakes varies from a short rupture along the Northern California and Southern Oregon Coast, to a rupture along the entire length of the subduction zone from Northern California to British Columbia. There is about a 37 percent chance in the next 50 years of a Magnitude 8+ earthquake originating on the southern portion of the CSZ and up to a 15 percent chance in the next 50 years of a great earthquake affecting the entire Pacific Northwest. The scenario involving rupture of the Northern Oregon portion would significantly impact all Western Oregon, including Newberg.



Figure 2.1 – Six-Step Process to Planning for Community Resilience (NIST, 2015)

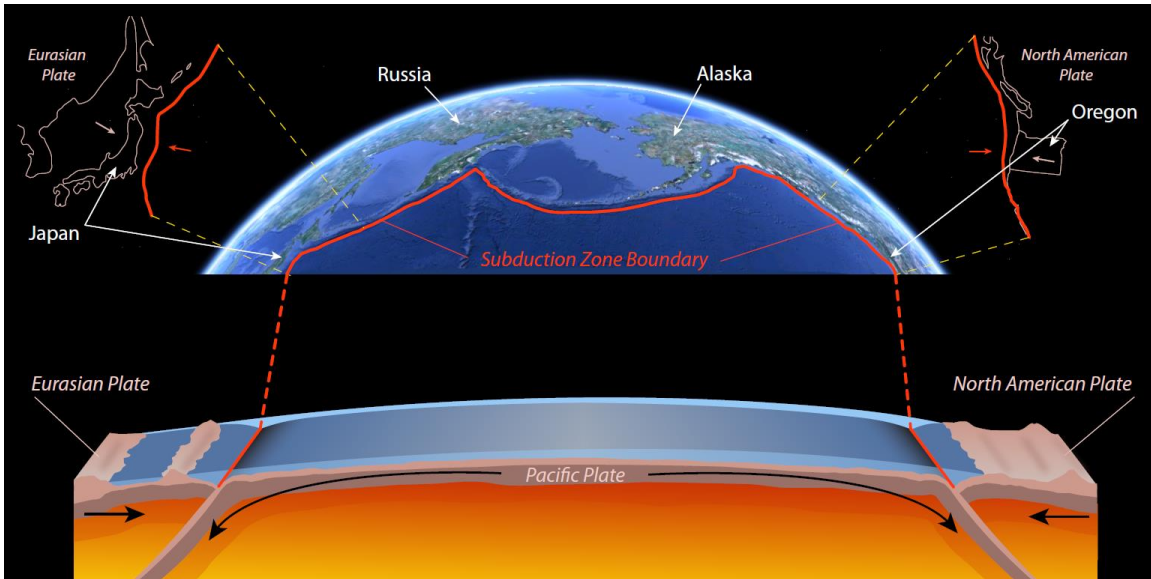


Figure 2.2 – Oregon and Northern Japan Mirror Image Subduction Zones (OSSPAC, 2013)

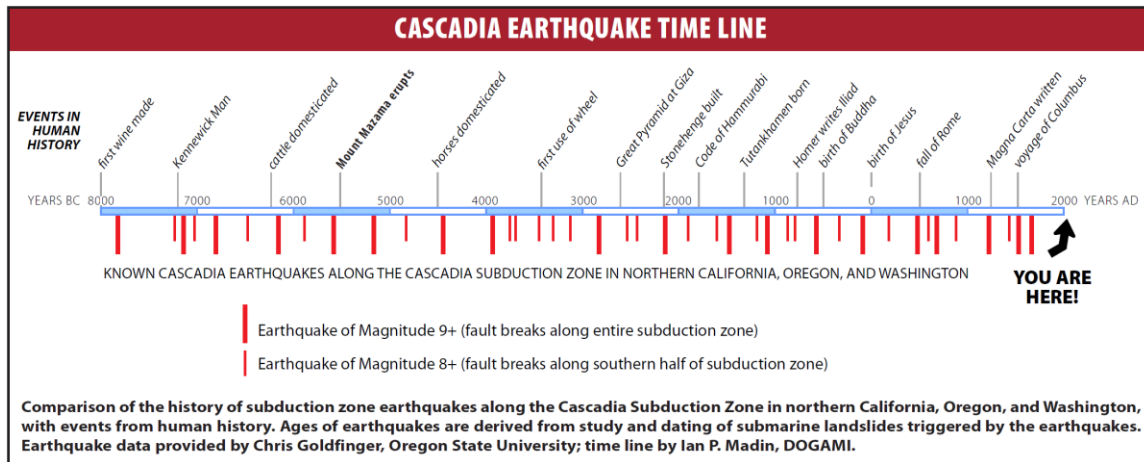


Figure 2.3 – Historic Cascadia Subduction Zone Earthquake Timeline (DOGAMI, 2010)

3.0 Level of Service Goals

Resilience planning involves establishing level of service (LOS) goals to define system performance expectations after being impacted by the hazard under consideration. These LOS goals could be simple, such as maintain service for 100 percent of customers during a routine winter storm that disrupts commercial electrical power for 24 hours, or they may be more complex for more damaging hazards like major earthquakes. This section presents examples of LOS goals included in other plans and then describes the LOS goals suggested for adoption by the City of Newberg for the water system.

3.1 SPUR Resilient City

In one of the first studies of its kind, the San Francisco Planning + Urban Research Association (SPUR) developed a series of policy papers aimed at raising awareness of how San Francisco’s buildings and lifeline infrastructure are likely to perform in an expected earthquake and identifying actions that could be implemented before an earthquake to improve the City’s resilience. The report outlined the importance of how the restoration timeline for water, wastewater, electrical power, and other lifeline systems impacts the speed with which a community can return to normal after a major disruption (SPUR, 2009). The report established the goals of restoring lifeline services to: 1) 90 percent of customers within 72 hours, 2) 95 percent of customers within one month, and 3) 100 percent of customers within four months after an expected level earthquake. It is assumed that critical facilities (e.g., hospitals, emergency operations centers, etc.) would be included in the 90 percent of customers restored within 72 hours. For buildings, the SPUR report defines the expected level earthquake as one having a 10 percent probability of occurring in a 50-year period and compares it to a magnitude 7.2 earthquake on the peninsula segment of the San Andreas Fault. The SPUR report also indicated that for lifeline systems, that typically have a longer design life than buildings, a larger expected level earthquake should be considered.

3.2 Oregon Resilience Plan

The threat of a Cascadia earthquake is a significant enough physical, economic, and social risk in the Pacific Northwest that in 2012 and 2013, at the request of the State of Oregon Legislative Assembly, the Oregon Seismic Safety Policy Advisory Commission (OSSPAC) and a team of volunteer professionals developed the *Oregon Resilience Plan: Reducing Risk and Improving Recovery for the Next Cascadia Earthquake and Tsunami* (OSSPAC, 2013). The *ORP* outlines steps that can be taken over a 50-year period to bring the state closer to resilient performance through a systematic program of vulnerability assessments, capital investments in buildings and infrastructure systems, new incentives to engage the private sector, and policy changes that reflect current understanding of the Cascadia threat to our community and economy.

OSSPAC assembled eight task groups, comprising over 160 volunteer subject-matter experts from government, universities, the private sector, and the general public. Task Groups included: (1) Cascadia earthquake scenario, (2) business and workforce continuity, (3) coastal communities, (4) critical and essential buildings, (5) transportation, (6) energy, (7) information and communications, and (8) water and wastewater. Task Group activities were overseen by OSSPAC and an Advisory Group. Each Task Group was charged to:

- Determine the likely impacts of a Magnitude 9.0 Cascadia earthquake and tsunami on its assigned sector, and estimate the time required to restore functions in that sector if the earthquake were to strike under present conditions;
- Define acceptable timeframes to restore functions after a future Cascadia earthquake to fulfill expected resilient performance; and
- Recommend changes in practice and policies that, if implemented during the next 50 years, will allow Oregon to reach the desired resilience targets.

The various task groups used estimates of the seismic hazard and expected ground motions developed by the Cascadia Earthquake Scenario Task Group in combination with knowledge of the construction era and condition of existing infrastructure to estimate the expected performance and service restoration times if the scenario event were to occur at the time the *ORP* was being developed.

The *ORP* used the SPUR model as a starting point for developing LOS goals (target timelines for restoration of services) after a Cascadia earthquake. These restoration targets were established assuming system resilience enhancements would be implemented over the following 50 years. These targets were set for three levels of service:

- Minimal level of service restored for the use of emergency response;
- Functional level of service up to 50 percent of capacity that is sufficient to get the economy moving again, and an
- Operational level of service where restoration is up to 90 percent of capacity (which may still rely on temporary fixes).

Table 3.1 summarizes the *ORP*'s goals for the restoration of water service for the Willamette Valley (after 50 years of resilience improvements) and compares it to the expected performance if the earthquake were to have occurred at the time the *ORP* was written. The time differences between the *ORP* restoration target (LOS) goal and expected performance illustrates the resilience gaps that require investment in infrastructure improvements, and public policy enhancements over the coming years.

**Table 3.1 – ORP Water System Recovery Goals: Valley Zone
(adapted from OSSPAC 2013)**

	0-24 hours	1-3 days	3-7 days	1-2 weeks	2-4 weeks	1-3 months	3-6 months	6-12 months	1-3 years	3+ years
Potable water available at supply source (WTP, wells, impoundment)	R	Y		G			X			
Main transmission facilities, pipes, pump stations, and reservoirs (backbone) operational	G					X				
Water supply to critical facilities available	Y	G				X				
Water for fire suppression – at key supply points	G		X							
Water for fire suppression – at fire hydrants			R	Y	G			X		
Water available at community distribution centers/points		Y	G	X						
Distribution system operational		R	Y	G				X		

Key to Table

Target Timeframe for Recovery:

- Desired time to restore components to 20-30% operational
- Desired time to restore components to 50-60% operational
- Desired time to restore components to 80-90% operational
- Current state (90% operational)

R
Y
G
X

3.3 NIST Community Resilience Planning Guide

The authors of the NIST *Guide* built upon the framework established by SPUR and the *ORP* in developing recommendations for community resilience planning. The categories, for which restoration timeline goals should be set, were further expanded to consider additional system components and to clarify that restoration timelines will likely vary based on the building cluster that is being supported (critical facilities, emergency housing, housing/neighborhoods, etc.). The *Guide* does not make recommendations for recovery timelines but provides a framework that communities can use to collectively establish these recovery timeline goals. The expanded *Guide* performance goal table

along with the restoration timeline goals established by the *ORP* have been used in developing level of service goals for this project. Further description of the recommended City of Newberg water system level of service goals developed as part of this project is provided in Section 3.8.

3.4 San Francisco Public Utilities Commission

The San Francisco Public Utilities Commission (SFPUC) outlines seismic design requirements in an agency specific engineering standard, *General Seismic Requirements for Design of New Facilities and Upgrade of Existing Facilities* (SFPUC, 2014). The purpose of the Standard is “to set forth consistent criteria for the seismic design and retrofit of San Francisco’s water and wastewater infrastructures. These systems comprise buildings, aboveground and underground piping, retaining walls, underground structures, tanks and basins, dams and reservoirs, special structures, and equipment under the jurisdiction of the SFPUC.”

The SFPUC Standard establishes that the water system basic level of service goal is to deliver winter day demand (WDD) within 24 hours after a major earthquake. For critical and non-redundant structures and components, this major earthquake is defined as having a 5% probability of exceedance in 50 years (975-year return period). The basic level of service goal also considers several supplemental criteria that include (SFPUC, 2014):

- Deliver WDD to at least 70% of SFPUC wholesale customers’ turnouts within each of the three customer groups;
- Achieve a 90% confidence level of meeting the above goal, given the occurrence of a major earthquake;
- To achieve the basic level of service, the SFPUC shall rely on the wholesale customer’s own water systems and supply or other regional water purveyor’s systems. SFPUC will work with customers to assess their ability to contribute to their own system reliability;
- The SFPUC shall consider a facility to have failed if it cannot be brought back to its intended purpose within 24 hours without secondary damage resulting; and
- To achieve the basic level of service, the SFPUC shall assume that power supplies are available, whether from the grid or from standby sources.

The SFPUC shall assume that no significant repairs are performed in the first 24 hours following a major earthquake. Possible operations that might occur during the first 24 hours include valve operations, temporary bypasses, and restoration of minor planned outages, if regional infrastructure remains intact.

3.5 Community Needs Following a Major Earthquake

To support the region’s economic and community recovery after a major disaster, infrastructure services are required to be restored as the building clusters that rely on these services come back online (i.e., a building that will take six months to reopen due to repair of structural damage doesn’t need water service until the end of that six months). In some cases, like that for smaller businesses, an outage of critical services like water for more than a few weeks may mean a business cannot return to a location. The current expectation of many Oregonians is that water service will be restored within one month after a major earthquake (City Club, 2017). The water system recovery goals suggested in the *ORP* are generally consistent with this public expectation. The *ORP* also sets goals for partial recovery in the initial days and weeks after a major earthquake with the aim of supporting rapid economic and social recovery.

Given that it would be cost prohibitive to eliminate all earthquake damage, a fundamental short-term community need will be to provide water for fire suppression and for use by hospitals, emergency shelters, and other similar facilities. Immediately after the event, it is anticipated that the City of Newberg will focus on repairing any damage to the water system supplying these critical customers and then quickly transition to restoring water service to other customers. This goal for rapid restoration of the water service will help support the Newberg Community’s desire that residents will be able to shelter-in-place in their homes immediately after a major earthquake and that they will be able to resume a semi-normal daily routine after two to four weeks by returning to school/work, shopping at their local grocery store, receiving medical care at their local clinic, etc. All these normal activities involve the use of water. At first it is expected that temporary measures will be required to distribute water, but as the weeks progress more permanent fixes will be implemented and the temporary measures will slowly disappear. The City may also be challenged by an influx of people displaced from coastal communities that were severely impacted by the earthquake and associated tsunami. Therefore, the post-disaster emergency water demand could increase to support additional short-term residents.

Table 3.2 provides a breakdown of restoration priorities for City customers that was jointly developed in a collaborative workshop conducted with the HDR team and City of Newberg staff. The table links social/economic needs to restoration timeline goals [short-term (no disruption), short-term (1-3 days), intermediate-term (within 4 weeks), and long-term (months)]. Note that these restoration timeline goals have been established based on our current understanding of the community’s social and economic needs, without consideration or knowledge of the current expected seismic performance of these existing community facilities. In order to support community social and economic needs on a timeline that is similar to that proposed for the water system, many of these community facilities may need to be seismically retrofit or replaced with new buildings designed with a higher structural and nonstructural performance objective. If a facility that is critical to supporting community short- and intermediate-term social/economic needs is relocated, site selection criteria for the new location should consider proximity to

the water system backbone or the water system backbone should be appropriately modified to include the location of the new facility.

Table 3.2 – City of Newberg Social/Economic Recovery Goals

Response/Recovery Phase	Social/Economic Needs
<p align="center">Short-Term (no disruption)</p>	<ul style="list-style-type: none"> • Water Supply Points for Fire Suppression <ul style="list-style-type: none"> ○ North Valley and Corral Creek Reservoirs ○ Newberg High School ○ Chehalem Valley Middle School ○ Edwards and Joan Austin Elementary Schools ○ George Fox University ○ Portland Community College ○ Rogers Landing (drafting from Willamette River) • Providence Newberg Medical Center
<p align="center">Short-Term (1-3 days)</p>	<ul style="list-style-type: none"> • Newberg Public Safety Building (Police Station, City EOC) • Fire stations <ul style="list-style-type: none"> ○ TVF&R Station #20 and #21 • Community Water Distribution Points <ul style="list-style-type: none"> ○ Calvary Chapel Newberg ○ Chehalem Glenn Golf Course ○ Church of Jesus Christ of Latter-Day Saints ○ Family Life Church ○ First Presbyterian Church ○ Grace Baptist Church ○ George Fox University ○ Newberg Christian Church ○ Newberg Friends Church ○ Northside Community Church ○ River Street Church of God ○ Seventh Day Adventists ○ Zion Lutheran Church • Urgent Care Centers <ul style="list-style-type: none"> ○ Newberg Urgent Care ○ Providence Express Care • Dialysis Center (Fresenius Kidney Care) • Emergency shelters <ul style="list-style-type: none"> ○ Newberg High School ○ Chehalem Valley and Mountain View Middle Schools ○ Edwards Elementary School ○ George Fox University (locations TBD) • Senior Care Facilities <ul style="list-style-type: none"> ○ Arbor Oaks Terrace ○ Astor House at Springbrook ○ Avamere Newberg ○ Brookdale Newberg ○ Friendsview Retirement Community ○ Friendsview Springbrook Meadows ○ Marquis Newberg ○ Willow Place

Table 3.2 – City of Newberg Social/Economic Recovery Goals (cont.)

Response/Recovery Phase	Social/Economic Needs
<p>Short-Term (cont.) (1-3 days)</p>	<ul style="list-style-type: none"> • Sportsman Airpark (supplied by Sam Whitney Water District) • Wastewater Treatment Plant (pump seal water) • Public Works Department buildings • Newberg School District Office
<p>Intermediate-Term (within 4 weeks)</p>	<ul style="list-style-type: none"> • Water District Customers <ul style="list-style-type: none"> ○ Chehalem Terrace ○ Chehalem Valley ○ NW Newberg ○ Sunny Acres ○ West Sheridan • City of Newberg facilities • Remaining Newberg School District facilities • Medical office buildings • 90% of customer connections • 90% of fire hydrants
<p>Long-Term (months)</p>	<ul style="list-style-type: none"> • Remaining 10% of customer connections • Remaining 10% of fire hydrants

3.6 Water Supply Points for Fire Suppression

Table 3.2 and Figure 3.1 identify the potential location of nine key supply points distributed throughout the city where tanker trucks could obtain water for fire suppression if the hydrant system is down following a major earthquake. At the two reservoir sites, it may be necessary to install seismic shutoff valves to preserve water storage, install segments of hardened pipe, and upgrade roadway access to the reservoirs. At the fire water distribution points within the city, it is anticipated that hydrants will be installed that are connected to the hardened backbone system and are designed to accommodate any expected permanent ground deformation. The Rogers Landing Boat Launch is proposed as an alternative site where fire trucks could draft water from the Willamette River.

3.7 Community Water Distribution Points

Table 3.2 and Figure 3.2 identify the potential location of 12 community water distribution points throughout the city where city residents could obtain potable water following a major earthquake. The City of Newberg Public Works Department is working with faith-based organizations to provide the manpower necessary to operate these water distribution sites. At the community water distribution points, it is recommended that hydrants be installed that are connected to the hardened backbone system and are designed to accommodate any expected permanent ground deformation.

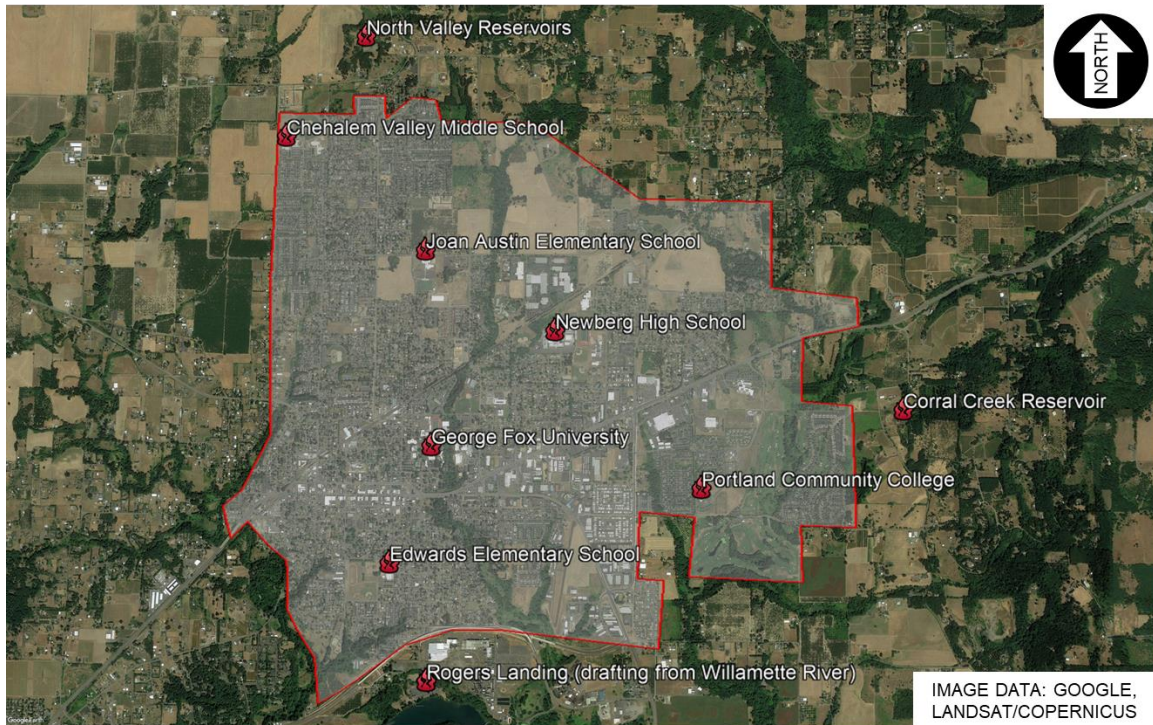


Figure 3.1 – Potential Water Supply Points for Fire Suppression

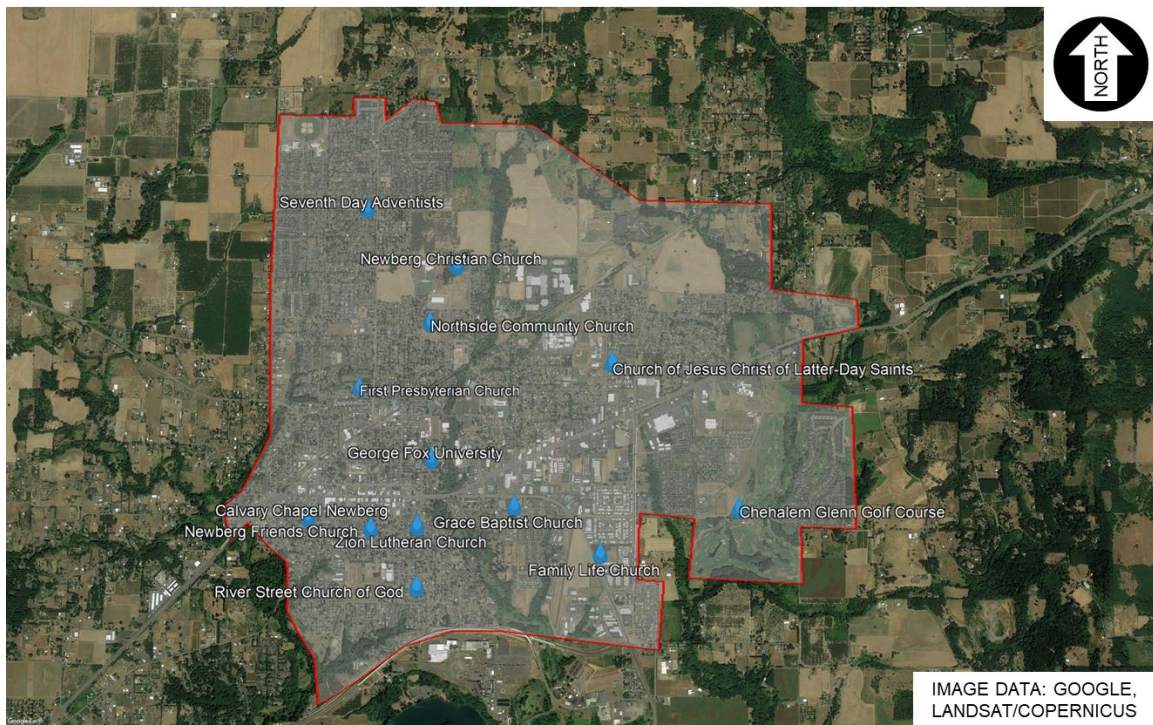


Figure 3.2 – Potential Community Water Distribution Points

3.8 City of Newberg Water System Level of Service Goals

The *ORP* was developed assuming a three-tiered LOS goal approach to implement a phased restoration of services and help define the speed of recovery for a community's infrastructure systems. The *ORP* recommended a timeline for these three-tiered LOS goals but provided the flexibility for an individual utility to define how the levels of functional restoration are to be achieved for their specific system. The LOS (i.e., restoration timeline) goals proposed for adoption by the City of Newberg align with those presented in the *ORP* and are augmented by additional considerations suggested by the *NIST Guide*. Table 3.3 summarizes these goals for the City of Newberg water system broken down in terms of specific goals for source, transmission, control systems, and distribution. All goals are based on providing water meeting minimum regulatory requirements, although a boil water notice may be in effect due to damage throughout the distribution system. Table 3.3 provides additional information about the recommended definition of 30%, 60%, and 90% operational for City of Newberg water system infrastructure. For example, the 90% operational goal for hospital facilities has been defined to mean that the City of Newberg water system is capable of delivering 90% of their average winter day demand of water meeting minimum regulatory requirements to hospital facilities within the City of Newberg service area.

**Table 3.3 – City of Newberg Water System Recovery Goals
(adapted from OSSPAC 2013 and NIST 2015)**

Water Systems	Target Timeframe for Recovery							
	Phase 1: Short-Term			Phase 2: Intermediate			Phase 3: Long-Term	
	Days			Weeks			Months	
	0-1	1-3	3-7	1-2	2-4	4-12	3-6	6-12
Source								
Raw or source water and terminal reservoirs	30% AWDD ^a	60% AWDD		90% AWDD				
Raw water conveyance (pump stations and piping to WTP)	30% AWDD	60% AWDD		90% AWDD				
Water Production	30% AWDD	60% AWDD		90% AWDD				
Well and/or Treatment operations functional	30% AWDD	60% AWDD		90% AWDD				
Transmission								
Backbone transmission facilities (pipelines, pump station, and tanks)	90% AWDD							
Water for fire suppression at key supply points (to promote redundancy)	90% of required fire flow and duration available							
Control Systems								
SCADA and other control systems	90% of components required for normal operation are functional							
Distribution								
Critical Facilities								
Hospitals	90% of AWDD							
EOC, Police Stations, Fire Stations, Public Works Buildings	60% of AWDD	90% AWDD						
Emergency Housing								
Emergency Shelters	60% of emergency water for drinking/sanitation	90% of emergency water for drinking/sanitation						
Housing/Neighborhoods								
Potable water available at community distribution centers		60% of emergency water for drinking/sanitation	90% of emergency water for drinking/sanitation					
Water for fire suppression at fire hydrants			30% of hydrants restored	60% of hydrants restored	90% of hydrants restored			
Community Recovery Infrastructure								
All other clusters			30% of customer connections restored	60% of customer connections restored	90% of customer connections restored			

^a AWDD = Average Winter Day Demand

Key to Table

Desired time to restore components to 30% operational R
 Desired time to restore components to 60% operational Y
 Desired time to restore components to 90% operational G

4.0 City of Newberg Backbone System Supporting Short-Term Community Needs

Satisfying short-term LOS restoration timeline goals requires critical components of the water production, treatment, transmission, and distribution system to remain operational or experience only minor damage after a major earthquake. These critical system components usually include: small diameter distribution pipelines and associated reservoirs/pump stations that connect to critical and essential facilities (hospitals, emergency shelters, etc.), large diameter transmission pipelines and associated pump stations, treatment plant structures, and certain support facilities (laboratories, maintenance shops, etc.). If an assessment of these critical system components reveals any gaps between the expected performance and that required to achieve the LOS goals, then these deficient components should be seismically retrofit or replaced, as appropriate.

The HDR team has collaborated with the City of Newberg to identify the proposed backbone for the City water system shown in Figure 4.1. The backbone system provides water distribution system connections between the well field, raw water transmission pipelines, water treatment plant, finished water reservoirs, and distribution system pipelines that serve facilities that are required to meet short-term community needs (see Table 3.2). The backbone systems proposed for the City of Newberg water system is consistent with that envisioned during the development of the *ORP*. The backbone includes elements of the water system that are required to meet short-term LOS restoration timeframe goals in the initial days after a major earthquake. Since it would be challenging to implement any significant repairs to the backbone system in the initial days after an earthquake, the elements of the backbone system should be designed or retrofit such that they experience only minor or no geotechnical, structural, and nonstructural related damage during a major earthquake.

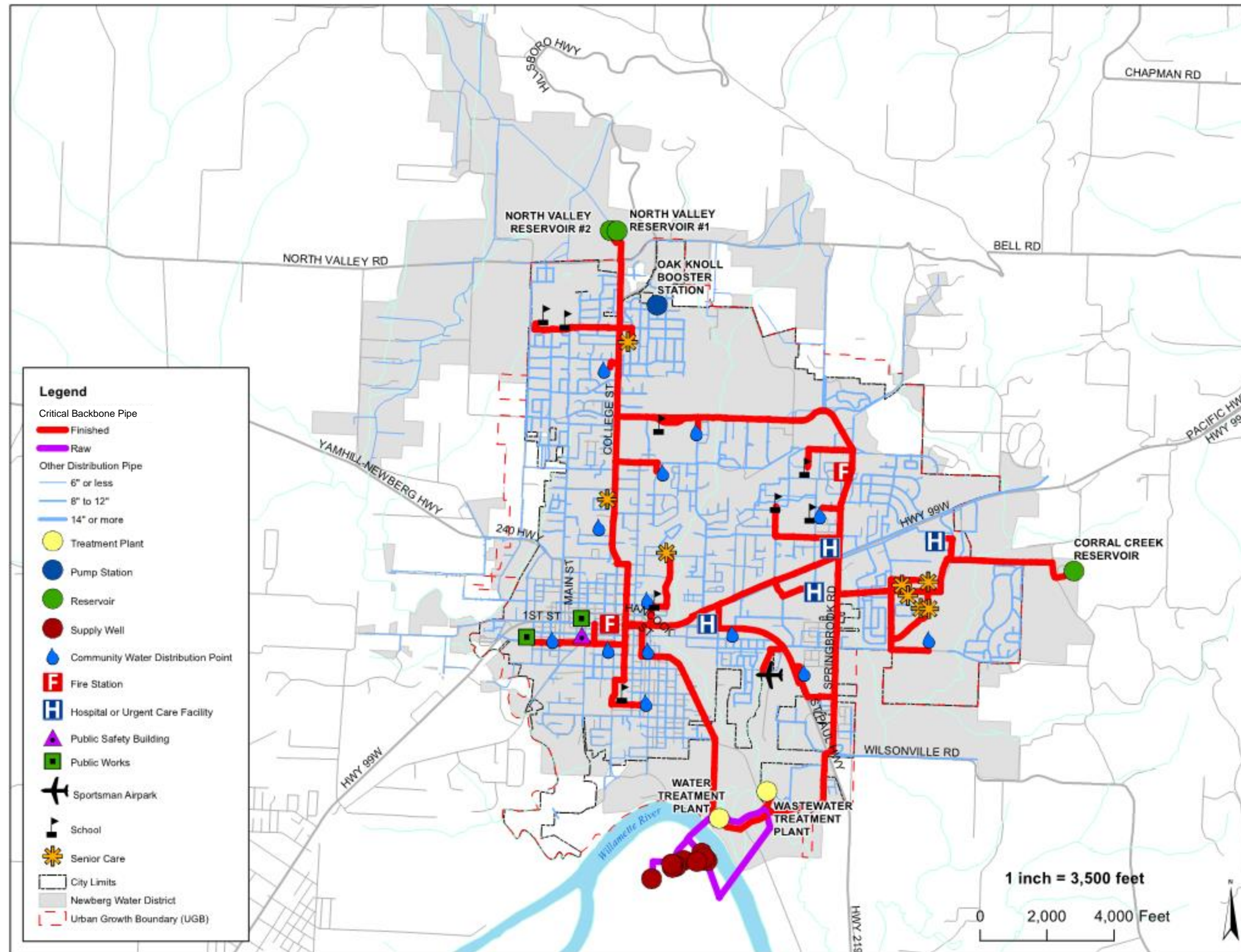


Figure 4.1 – City of Newberg Water System Backbone

5.0 Translation of Level of Service Goals into System Performance Requirements

Several factors need to be taken into consideration when translating the City of Newberg LOS goals into performance requirements for the seismic design or retrofit of water system components. Section 5.1 describes several of the factors that have been considered in developing the recommended general performance requirements detailed in Section 5.2.

5.1 Considerations

The following subsections describe factors considered in developing performance requirements for the various components of the City of Newberg water system. For future water system projects, these factors should also be evaluated on a project-specific basis to determine if there are any unique features of the project that require modification of the general seismic resilience-based performance requirements.

5.1.1 Geotechnical Hazards

Observations from past earthquakes have indicated that geotechnical hazards are a major contributing factor to the expected post-earthquake performance of water systems. Infrastructure that is exposed to liquefaction, lateral spreading, or landslide geotechnical hazards requires special design considerations that include either mitigation measures to address the geotechnical hazard or predetermined work-arounds to bypass components that may fail during an earthquake. Water treatment plants can be particularly vulnerable to damage from earthquake-induced liquefaction and lateral spreading because these facilities are often constructed in low-lying areas near water sources. These areas correspond with those at high risk for liquefaction and lateral spreading. Transmission and distribution piping that crosses creeks or other low-lying areas are also particularly vulnerable to damage from earthquake-induced liquefaction and lateral spreading.

5.1.2 Effects of Aftershocks

Major earthquakes are often accompanied by numerous aftershocks. In the 2011 Tohoku Japan earthquake two major aftershocks caused additional damage to infrastructure systems, resulting in relapses in the number of customer outages (Nojima, 2012). It may be necessary to reevaluate system components or perform additional repairs after major aftershocks.

5.1.3 Repair Difficulty

Certain water system components (like large diameter transmission mains) may be very difficult to repair after an earthquake. If a component is anticipated to be difficult to repair and it is also important to system performance, then it should be designed to minimize any potential earthquake damage that would impact the functionality of the component. Other assets of this type could include pipes under railroad tracks or highways.

5.1.4 Availability of Public Works Department Staff

The first priority for many City of Newberg Public Works Department staff in the initial hours and days following a major earthquake will be to ensure the health and safety of their families. Once those critical needs are addressed, City of Newberg Public Works Department staff will, ideally, be available to report to work. However, even after they return to work, it is possible that the City Emergency Manager may assign Public Works Department staff to work on non-water system related tasks that are deemed more critical to the City's disaster response activities. This scenario suggests that Public Works Department staff may have limited ability to perform repairs or implement predetermined work-arounds in the initial hours and days after an earthquake. Critical components of the water system that are required to be operational within the first 3-7 days after an earthquake should be designed or seismically retrofitted to remain operational during and immediately after a major earthquake.

5.1.5 Availability of Design Professionals and Contractors

The restoration timeline goals and required repairs must be in line with the anticipated availability of qualified design professionals and contractors to design and implement the repairs. It is anticipated that the design and construction of major repairs to a pump station or treatment plant structure would take between 6-12 months. It is anticipated that the design and construction that replaces a pump station or treatment plant structure would take a minimum of 18 months. These timeframes may increase if the City decides to rebuild the pump stations to a higher standard of performance, i.e., a resilient design, which may require more planning and design time.

5.1.6 Availability of Repair Materials or Replacement Equipment

The City of Newberg maintains limited supplies of emergency repair materials, but these supplies are not anticipated to be adequate for the number of repairs that may be necessary after a major earthquake. For disasters that impact a relatively small geographic region, it is possible that other nearby utilities could lend repair supplies. However, a CSZ earthquake will impact the entire Pacific Northwest (from Northern California to British Columbia) and relying on neighboring utilities as a potential source for repair materials is likely impractical.

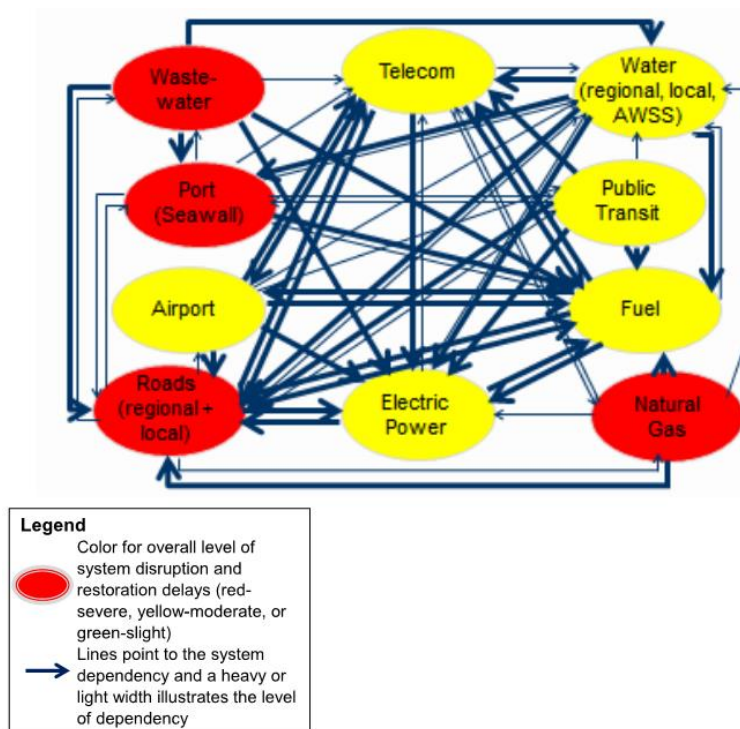
Additionally, some equipment used in pump stations and treatment plants is not available from manufacturer's stock and has a long lead time for production. Special consideration must be given to this difficult-to-source equipment to ensure that it is either not damaged during an earthquake, a predetermined work-around has been established, or the equipment manufacturing lead time aligns with restoration timeline goals.

5.1.7 Infrastructure Dependencies

The restoration of water system infrastructure is highly dependent on other infrastructure systems. Examples of these dependencies include:

- Co-location with and damage to other lifeline systems (roads, bridges, wastewater pipes, etc.);
- Liquid fuel availability for trucks, generators, and equipment;
- Commercial electrical power;
- Transportation system for delivery of repair materials and mutual aid assistance crews; and
- Cellular communications system for coordination of City of Newberg staff and contractors.

The level of service goals and performance requirements suggested in this report assume that all lifeline service providers will be making significant investments in the earthquake resilience of their systems in the next 45 years. If one or more lifeline sectors do not make these system improvements, then the speed of community recovery could be greatly impacted because of the dependencies between all infrastructure systems. Figure 5.1 shows an example of the complicated dependency relationships among lifelines in the San Francisco Bay Area (City and County of San Francisco Lifelines Council, 2014). Heavy and light lines widths depict the relative level of dependencies anticipated to occur between the various lifelines systems following a scenario M7.9 earthquake on the San Andreas fault.



**Figure 5.1 – Lifeline Interdependencies in the San Francisco Bay Area
(City and County of San Francisco Lifelines Council, 2014)**

5.2 Water System Structures

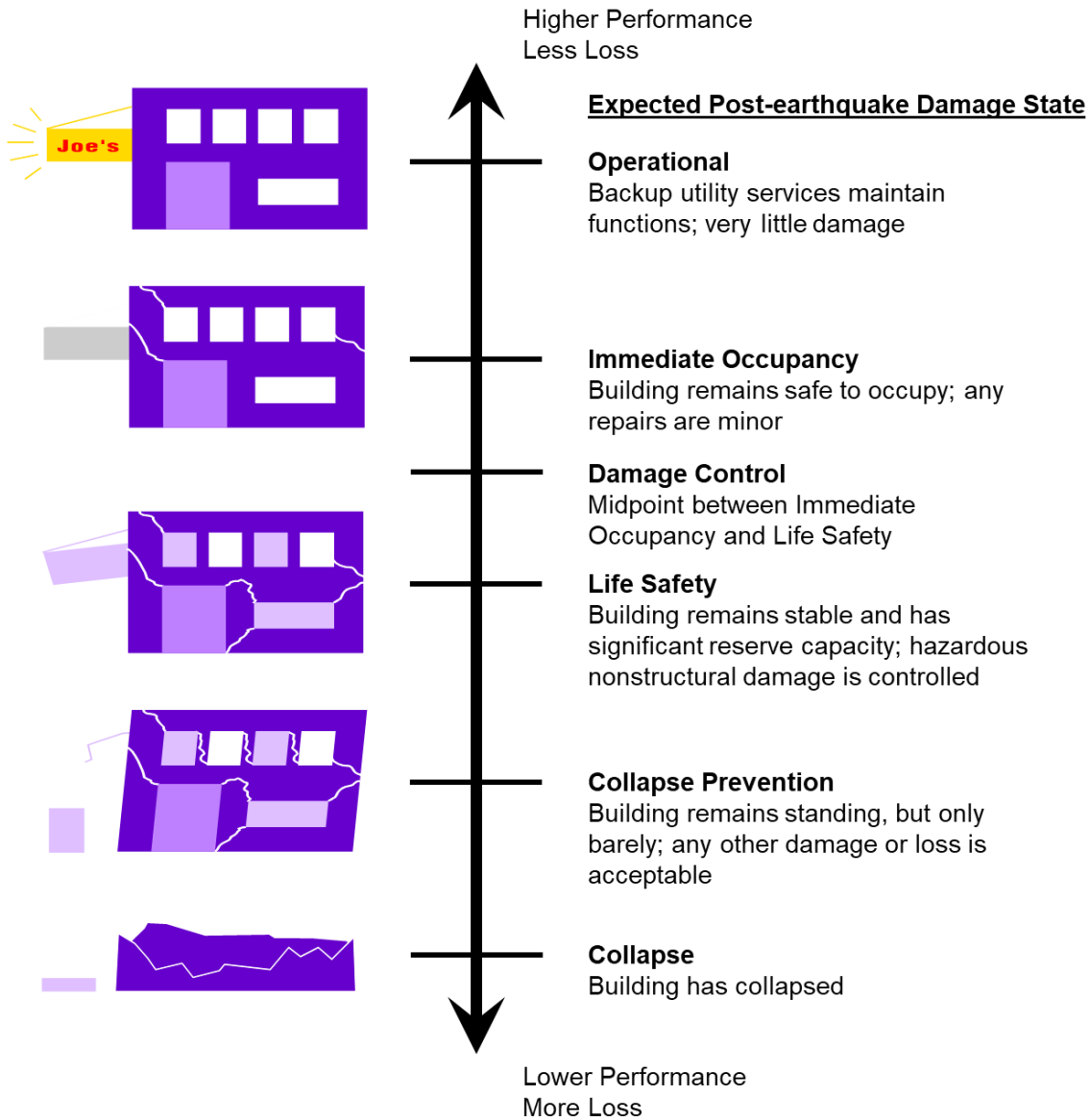
Water system structures (reservoirs, pump stations, etc.) required to maintain water pressure for fire suppression are designated as Risk Category IV structures and water system structures not required to maintain water pressure for fire suppression are designated as Risk Category III structures according to the requirements of the latest edition of the *Oregon Structural Specialty Code* (OSSC, 2014). For new structures, the construction cost increase associated with elevating the design standard from Risk Category III to Risk Category IV is typically relatively minor. Therefore, it is recommended that all new water system structures should be designed per the more stringent *Oregon Structural Specialty Code* seismic design requirements for Risk Category IV structures. Also, since geotechnical hazards (e.g., liquefaction and lateral spreading, etc.) can significantly impact the performance of water system structures following a major earthquake, it is recommended that site-specific geotechnical investigations and analysis be conducted to characterize these potential hazards. Water system structure designs should include appropriate measures to mitigate these potential site-specific geotechnical hazards. Equipment associated with water system structures should be adequately braced and seismically certified, per the requirements of the latest edition of *ASCE 7, Minimum Design Loads for Buildings and Other Structures* (ASCE, 2017a), so that it could remain operational after a design level earthquake, as long as dependent systems are also functional [e.g., electrical power (emergency generator or commercial), etc.]. Piping entering or exiting water system structures should be designed to accommodate the anticipated earthquake-induced relative movement between the structure and surrounding soil.

In order to meet the target LOS goals, water system structures need to meet or exceed defined levels of structural and nonstructural seismic performance. ASCE 41-17, *Seismic Evaluation and Retrofit of Existing Buildings* (ASCE, 2017b), presents several structural and nonstructural seismic performance objectives and describes the expected level of earthquake damage associated with each performance objective. Also included are expectations about the operability and reparability of earthquake damage for these various performance objectives. The ASCE 41-17 descriptions of these performance objectives are provided below and summarized in Figure 5.2. Table 5.1 provides a comparison between these performance objectives and the intended performance associated with *Oregon Structural Specialty Code* Risk Categories.

Table 5.1 – Comparison of Seismic Performance Objectives with OSSC Risk Categories

Risk Category	Performance Objective ^a	
	Structural	Nonstructural
IV	Immediate Occupancy	Operational
III	Damage Control	Position Retention
I & II	Life Safety	Position Retention

^a For the BSE-1N seismic hazard level as defined by ASCE 41-17



**Figure 5.2 – Building Performance Objectives
 (adapted from ASCE, 2017b)**

Structural Performance Objectives

Immediate Occupancy: “Immediate Occupancy” refers to the post-earthquake damage state in which only very limited structural damage has occurred. The basic vertical- and lateral-force-resisting systems of the building retain almost all their pre-earthquake strength and stiffness. The risk of life-threatening injury from structural damage is very low, and although some minor structural repairs might be appropriate, these repairs would generally not be required before re-occupancy. Continued use of the building is not limited by its structural condition but might be limited by damage or disruption to nonstructural elements of the building, furnishings, or equipment and availability of external utility services.

Damage Control: “Damage Control” refers to a midway point between Life Safety (see next description) and Immediate Occupancy (see previous description). This performance objective is intended to provide a structure with a greater reliability of resisting collapse and being less damaged than a typical structure, but not to the extent required of a structure designed to meet the Immediate Occupancy Performance Level. Although this level is a numerically intermediate level between Life Safety and Immediate Occupancy, the two performance objectives are essentially different from each other. The primary consideration for Immediate Occupancy is that the damage is limited in such a manner as to permit reoccupation of the building, with limited repair work occurring while the building is occupied. The primary consideration for Life Safety is that a margin of safety against collapse be maintained and that consideration for occupants to return to the building is a secondary impact to the Life Safety objective being achieved. The Damage Control Performance Level provides for a greater margin of safety against collapse than the Life Safety Performance Level would. The level might control damage in such a manner as to permit return to function more quickly than the Life Safety Performance Level, but not as quickly as the Immediate Occupancy Performance Level does.

Life Safety: “Life Safety” refers to the post-earthquake damage state in which significant damage to the structure has occurred but some margin against either partial or total structural collapse remains. Some structural elements and components are severely damaged, but this damage has not resulted in large falling debris hazards, either inside or outside the building. Injuries might occur during the earthquake; however, the overall risk of life-threatening injury from structural damage is expected to be low. It should be possible to repair the structure; however, for economic reasons, this repair might not be practical. Although the damaged structure is not an imminent collapse risk, it would be prudent to implement structural repairs or install temporary bracing before re-occupancy.

Nonstructural Performance Objectives

Operational: “Operational” refers to the performance level where most nonstructural systems required for normal use of the building are functional, although minor cleanup and repair of some items might be required. Achieving the Operational nonstructural performance level requires considerations of many elements beyond those that are normally within the sole province of the structural engineer’s responsibilities. For Operational nonstructural performance, in addition to ensuring that nonstructural components are properly mounted and braced within the structure, it is often necessary to provide emergency standby equipment to provide utility services from external sources that might be disrupted. It might also be necessary to perform qualification testing to ensure that all necessary equipment will function during or after strong shaking.

Position Retention: “Position Retention” refers to the nonstructural condition of a building after an event where, presuming that the building is structurally safe, occupants can occupy the building safely, with some limitations: normal use might be impaired, some cleanup might be needed, and some inspection might be warranted. In general, building equipment is secured in place and might be able to function if the necessary utility service is available. However, some components might experience misalignments or internal damage and be inoperable. Power, water, natural gas, communications lines, and other utilities required for normal building use might not be available. Cladding, glazing, ceilings, and partitions might be damaged but would not present safety hazards or un-occupiable conditions. For this performance level, the risk of life-threatening injury caused by nonstructural damage is very low.

Detailed geotechnical and structural seismic evaluations should be conducted for existing water system structures to determine if their anticipated seismic performance will enable LOS goals to be achieved. To satisfy the target water system restoration timeline, structures that must be operational soon after a major earthquake should be evaluated and if required, seismically retrofit to a more stringent structural and nonstructural performance level than those that are not required until later in the recovery phase. Table 5.2 provides the seismic retrofit criteria proposed for adoption by the City of Newberg for water system infrastructure in terms of the structural and nonstructural performance objectives presented in ASCE 41. These performance objectives are for the Basic Safety Earthquake-1 for use with the Basic Performance Objective Equivalent to New Building Standards (BSE-1N). This BSE-1N seismic hazard level is consistent with that used to design new structures per the *Oregon Structural Specialty Code*. Note that the proposed LOS goals require that the water system has essentially been restored to a 90% operational level within 2-4 weeks after a M9.0 CSZ earthquake. This would suggest that the majority of system components are capable of achieving Immediate Occupancy structural performance and Operational nonstructural performance. Table 5.2 also includes alternative (less stringent) retrofit performance objectives for system components that might not be required to be returned to service until 1-6 months or 6-12 months after the earthquake. For example, the City of Newberg may decide that one of

the reservoirs is not required to achieve short- and intermediate-term LOS goals and may elect to relax the restoration timeline goals for that particular water system structure.

Table 5.2 – Water System Seismic Retrofit Performance Objectives

Restoration Timeline	Retrofit Performance Objective ^a	
	Structural	Nonstructural
0-1 months	Immediate Occupancy	Operational
1-6 months	Immediate Occupancy	Position Retention ^b
6-12 months	Damage Control ^c	Position Retention ^b

^a For the BSE-1N seismic hazard level as defined by ASCE 41-17.

^b Assumes lead time for delivery and installation of damaged equipment falls within restoration timeline goals, otherwise equipment should be seismically certified per the requirements of the latest edition of ASCE 7.

^c Assumes that the structural damage can be repaired within restoration timeline goals. For earthquake damage that may be especially difficult to repair within the target timeline, structure should be retrofitted to satisfy the Immediate Occupancy performance objective.

6.0 Limitations

The opinions and recommendations presented in this report were developed with the care commonly used as the state of practice of the profession. No other warranties are included, either expressed or implied, as to the professional advice included in this report. This report has been prepared for the City of Newberg to be used solely in its evaluation of the seismic safety of the water system referenced. This report has not been prepared for use by other parties and may not contain sufficient information for purposes of other parties or uses.

References

- ASCE. (2017a) ASCE 7-16, *Minimum Design Loads for Buildings and Other Structures*, American Society of Civil Engineers, Reston, VA.
- ASCE. (2017b). ASCE 41-17, *Seismic Evaluation and Retrofit of Existing Buildings*, American Society of Civil Engineers, Reston, VA.
- City and County of San Francisco Lifelines Council. (2014) *Lifelines Interdependency Study I Report*, San Francisco, CA.
- City Club. (2017) *Big Steps Before the Big One: How the Portland area can bounce back after a major earthquake*, City Club of Portland, Portland, OR.
- DOGAMI. (2010) *Cascadia*, Winter 2010, Department of Geology and Mineral Industries, Salem, OR.
- FEMA. (2015) *National Preparedness Goal*, Federal Emergency Management Agency, Washington D.C.
- NIST. (2015) *Community Resilience Planning Guide for Building and Infrastructure Systems*, NIST Special Publication 1190, National Institute of Standards and Technology, Gaithersburg, MD.
- Nojima, N. (2012) Restorations and System Interactions of Lifelines in the Great East Japan Earthquake Disaster, 2011, *Proceedings of the International Symposium on Engineering Lessons Learned from the 2011 Great East Japan Earthquake*, Tokyo, Japan
- OSSC. (2014) *Oregon Structural Specialty Code*, International Code Council, Country Club Hills, IL.
- OSSPAC. (2013) *The Oregon Resilience Plan, Reducing Risk and Improving Recovery for the Next Cascadia Earthquake and Tsunami*, Oregon Seismic Safety Policy Advisory Commission, Salem, OR.
- SFPUC. (2014) *General Seismic Requirements for Design of New Facilities and Upgrade of Existing Facilities*, San Francisco Public Utilities Commission, San Francisco, CA.
- SPUR. (2009) *Lifelines: Upgrading Infrastructure to Enhance San Francisco's Earthquake Resilience*, San Francisco Planning + Urban Research Association, San Francisco, CA.



Appendix B: Geotechnical Engineering Report

SUBMITTED TO:
HDR, Engineering Inc.
1001 SW 5th Avenue,
Suite 1800
Portland, Oregon 97204

BY:
Shannon & Wilson, Inc.
3990 Collins Way, Suite 100
Lake Oswego, OR 97035

(503) 210-4750
www.shannonwilson.com

GEOTECHNICAL ENGINEERING REPORT
City of Newberg Water System
Seismic Resilience Study
NEWBERG, OREGON

PAGE INTENTIONALLY LEFT BLANK FOR DOUBLE-SIDED PRINTING

Submitted To: HDR, Engineering Inc.
1001 SW 5th Avenue,
Suite 1800
Portland, Oregon 97204
Attn: Joe Miller

Subject: GEOTECHNICAL ENGINEERING REPORT, CITY OF NEWBERG WATER
SYSTEM SEISMIC RESILIENCE STUDY, NEWBERG, OREGON

Shannon & Wilson prepared this report and participated in this project as a subconsultant to HDR Engineering, Inc. (HDR). Our scope of services was specified in the Geotechnical Subconsultant Agreement dated April 29, 2019. This report presents results of our geotechnical seismic hazard assessment for the City of Newberg's (the City) water system and service area for use in assessing the vulnerability of the City's critical infrastructure. The assessment was performed utilizing Geographic Information System (GIS) data and is based on the magnitude 9.0 Cascadia Subduction Zone (CSZ) scenario defined in the Oregon Resilience Plan (OSSPAC, 2013). Along with evaluating the seismic hazard within the City, we were also tasked with evaluating the seismic hazard and slope stability at the Water Treatment Plant (WTP).

We appreciate the opportunity to be of service to you on this project. If you have questions concerning this report, or we may be of further service, please contact us.

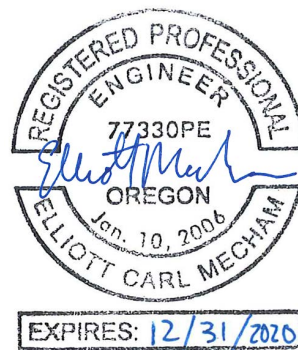
Sincerely,

SHANNON & WILSON, INC.

David Jacobson, GIT
Staff Geologist

Kevin Wood, PE
Senior Engineer

KJW:DSJ:WJP:ECM/cec



Elliott Mecham, PE
Associate | Engineer

CONTENTS

CONTENTS

1 SCOPE OF SERVICES1

2 SEISMIC HAZARD MAPPING1

 2.1 Approach.....1

 2.2 Existing Information Review2

 2.2.1 Regional Seismological Setting.....2

 2.2.2 Oregon Resilience Plan.....3

 2.2.3 Geology.....3

 2.2.4 Available Mapping.....5

 2.3 Modifications to Published Geologic Mapping6

 2.4 Seismic Hazard Maps6

 2.5 Shear Wave Velocity, Vs307

 2.6 Liquefaction Hazard7

 2.7 Landslide Susceptibility8

 2.8 PGA, SA1, SA0.3, and PGV.....8

 2.9 Probability of Liquefaction8

 2.10 Liquefaction-Induced PGD.....9

 2.10.1 Lateral Spreading9

 2.10.2 Settlement.....9

 2.11 Probability of Earthquake-Induced Landslides9

 2.12 Earthquake-Induced Landslide PGD9

 2.13 Seismic Hazards at Critical Infrastructure.....10

3 WATER TREATMENT PLANT SLOPE EVALUATION10

 3.1 Background10

 3.2 Subsurface Conditions.....11

 3.3 Groundwater.....11

 3.4 Seismic and Geologic Hazards.....11

 3.5 Strong Ground Motion.....12

 3.6 Liquefaction12

 3.7 Liquefaction Analysis and Liquefaction-Induced Settlement13

 3.8 Lateral Spreading13

3.9 Slope Stability14

 3.9.1 Approach14

 3.9.2 Static15

 3.9.3 Seismic15

 3.9.4 Post-Seismic.....15

 3.9.5 Results of the Slope Stability Analysis15

4 LIMITATIONS.....16

5 REFERENCES17

Exhibits

Exhibit 1: Site-Adjusted Peak Ground Acceleration12

Exhibit 2: Summary of Liquefaction-Induced Settlement13

Exhibit 3: Summary of Slope Stability Results.....15

Tables

Table 1: Seismic Hazards Mapped at Selected Infrastructure Locations

Figures

Figure 1: Geologic Map

Figure 2: Shear Wave Velocity, Vs30

Figure 3: Liquefaction Hazard

Figure 4: Landslide Susceptibility (Dry Conditions)

Figure 5: Landslide Susceptibility (Wet Conditions)

Figure 6: Peak Ground Acceleration, PGA

Figure 7: 0.3-Second Spectral Acceleration, SA0.3

Figure 8: 1-Second Spectral Acceleration, SA1

Figure 9: Peak Ground Velocity, PGV

Figure 10: Probability of Liquefaction

Figure 11: Liquefaction-Induced Lateral Spreading Permanent Ground Deformation, PGD

Figure 12: Liquefaction-Induced Settlement Permanent Ground Deformation, PGD

Figure 13: Probability of Earthquake-Induced Landslides (Dry)

Figure 14: Probability of Earthquake-Induced Landslides (Wet)

Figure 15: Earthquake-Induced Landslide Permanent Ground Deformation, PGD (Dry)

Figure 16: Earthquake-Induced Landslide Permanent Ground Deformation, PGD (Wet)

Figure 17: Water Treatment Plant Vicinity Map

Figure 18: Water Treatment Plant Slope Site and Exploration Plan

Appendices

Appendix A: Field Explorations

Appendix B: Slope Stability Summary Results

Important Information

CONTENTS

1 SCOPE OF SERVICES

The purposes of the HDR team's seismic hazard assessment are to define water system level-of-service goals, assess the existing system with respect to the levels of service, and develop recommended mitigation measures to address deficiencies. Shannon & Wilson's task is to prepare and provide GIS maps of:

- probability of liquefaction
- probability of earthquake-induced landslides
- liquefaction-induced permanent ground deformation
- earthquake-induced-landslide permanent ground deformations

To achieve these purposes, our scope of services included the following:

- Review existing geologic and geotechnical information;
- Develop seismic ground motion, seismic hazard, and permanent ground deformation hazard maps;
- Perform one boring at the WTP;
- Evaluate liquefaction potential and liquefaction-induced settlement at the WTP;
- Evaluate potential for slope failure for static, seismic, and post-seismic (liquefied) conditions using a limit equilibrium analyses and Slope-W software at the WTP;
- Evaluate seismically induced ground movement using Newmark-type analyses at the WTP;
- Evaluate potential for lateral spread using empirical methods at the WTP, and;
- Summarize the geotechnical evaluations at the WTP and provide maps for the seismic hazard assessment in a Technical Memorandum.

To support the team's structural vulnerability assessment, we also included maps of peak ground acceleration, 0.3- and 1-second spectral accelerations, peak ground velocity, and liquefaction-induced settlement in addition to the maps listed above.

2 SEISMIC HAZARD MAPPING

2.1 Approach

The GIS map layers developed for this project are primarily based on published geologic maps; variations from actual site conditions should be expected. Also, the analyses,

methods and approaches applied herein were developed and used by the Oregon Department of Geology and Mineral Industries (DOGAMI) and the Federal Emergency Management Agency (FEMA) for planning purposes only. They are not the same as those used for site-specific, code-based geotechnical design.

2.2 Existing Information Review

2.2.1 Regional Seismological Setting

Earthquakes in the Pacific Northwest occur largely as a result of the subduction of the Juan de Fuca plate beneath the North American plate along the Cascadia Subduction Zone (CSZ). The CSZ is located approximately parallel to the coastline from northern California to southern British Columbia. The compressional forces that exist between these two colliding plates cause the oceanic Juan de Fuca plate to descend, or subduct, beneath the continental plate at a rate of about 1.5 inches per year. This process leads to volcanism in the North American plate and stresses and faulting in both plates throughout much of the western regions of southern British Columbia, Washington, Oregon, and northern California. Stress between the colliding plates is periodically relieved through great earthquakes at the CSZ plate interface.

Within the regional tectonic framework and historical seismicity, three broad earthquake sources are identified:

- **Subduction Zone Interface Earthquakes** originate along the CSZ, which is located 25 miles beneath the coastline. Paleoseismic evidence and historic tsunami records from Japan indicate that the most recent subduction zone interface event was in 1700 AD and was an approximately magnitude 9 earthquake that likely ruptured the full length of the CSZ.
- **Deep-Focus, Intraplate Earthquakes** originate from within the subducting Juan de Fuca oceanic plate as a result of the downward bending and tension in the subducted plate. These earthquakes typically occur 28 to 38 miles beneath the surface. Such events on the CSZ are estimated to be as large as magnitude 7.5. Historic earthquakes include the 1949 magnitude 7.1 Olympia earthquake, the 1965 magnitude 6.5 earthquake between Tacoma and Seattle, and the magnitude 6.8 2001 Nisqually earthquake. The highest rate of CSZ intraslab activity is beneath the Puget Sound area, with much lower rates observed beneath western Oregon.
- **Shallow-Focus Crustal Earthquakes** are typically located within the upper 12 miles of the earth's surface. The relative plate movements along the CSZ cause not only east-west compressive strain but dextral shear, clockwise rotation, and north-south compression of the leading edge of the North American Plate (Wells and others, 1998), which is the cause of much of the shallow crustal seismicity of engineering significance in the region. The largest known crustal earthquake in the Pacific Northwest is the 1872

North Cascades earthquake with an estimated magnitude of about 7. Other examples include the 1993 magnitude 5.6 Scotts Mill earthquake and magnitudes 5.9 and 6.0 Klamath Falls earthquakes.

2.2.2 Oregon Resilience Plan

The Oregon Resilience Plan is a result of Oregon House Resolution 3, adopted in April 2011. The House Resolution directed the Oregon Seismic Safety Policy Advisory Commission “to lead and coordinate preparation of an Oregon Resilience Plan that reviews policy options, summarizes relevant reports and studies by state agencies, and makes recommendations on policy direction to protect lives and keep commerce flowing during and after a Cascadia earthquake and tsunami” (OSSPAC, 2013). A task group then developed a Cascadia Earthquake Scenario for use by other work groups as a basis for assessing the effects of the scenario on various sectors of society or parts of the built environment.

This assessment is for a magnitude 9.0 CSZ earthquake, as defined in the Oregon Resilience Plan. Other magnitudes of CSZ events and earthquakes from other sources are not considered.

2.2.3 Geology

The City of Newberg is located in the Willamette Valley physiographic province (Orr and others, 1992). The local geology has been mapped by numerous authors, including Schlicker and Deacon (1967), Frank and Collins (1978), Burns and others (1997), O’Connor and others (2001), and Wells and others (2018). A simplified geologic map of the City is presented in Figure 1 and is based on DOGAMI publications OGDC-6 (Smith and Row, 2015) and SLIDO 3.4 (Burns and Watzig, 2017).

Published mapping suggests that the city is underlain at depth by oceanic sandstone of the Scappoose Formation and basalt of the Columbia River Basalt Group (CRBG), which flowed in the area between about 17 million and 6 million years ago. These units are exposed at the ground surface along the northeast side of the city with smaller outcrops on the east and west sides of the city (see Figure 1).

Based on maps and cross sections prepared by Frank and Collins (1978), the CRBG in the project area is overlain by Pliocene (5.3 to 2.6-million-year-old) Troutdale Formation, which locally consists of silt and clay with occasional beds of sand and gravel. These sediments have historically been referred to by several names, including Troutdale Formation (Schlicker and Deacon, 1967; Frank and Collins, 1978), Sandy River Mudstone equivalent (Madin, 1990), and Hillsboro Formation (Wilson, 1998). These sediments, referred to in this report as Pliocene Alluvium, were deposited in local sub-basins that had been created by

extensive faulting and folding of the CRBG and underlying basement rocks (Schlicker and Deacon, 1967). In the vicinity of the City, small outcrops are mapped to the northeast and north (see Figure 1).

Throughout most of the City, the Pliocene Alluvium is concealed at the surface by Pleistocene flood sediments (see Figure 1). The Pleistocene flood sediments were deposited during repeated glacial outburst floods (O'Connor and others, 2001). During the late stages of the last great ice age, between about 18,000 and 15,000 years ago, a lobe of the continental ice sheet repeatedly blocked and dammed the Clark Fork River in western Montana, which then formed an immense glacial lake called Lake Missoula. The lake grew until its depth was sufficient to buoyantly lift and rupture the ice dam, which allowed the entire massive lake to empty catastrophically. Once the lake had emptied, the ice sheet again gradually dammed the Clark Fork Valley, and the lake refilled, leading to 40 or more repetitive outburst floods, at intervals of decades (Allen and others, 2009). The floods are collectively known as the Missoula Floods, and during each short-lived episode, floodwaters washed across the Idaho panhandle, through the eastern Washington scablands, and through the Columbia River Gorge.

When the floodwater emerged from the western end of the gorge, it deposited a tremendous load of boulders, cobbles, and gravel nearest the mouth of the gorge and along the main channel of the Columbia River. Floodwaters stretched along most of the Willamette Valley, creating a temporary lake known as Lake Allison (Orr and others, 1992). Once spread out, the lower-energy waters deposited variable thicknesses of micaceous sand and silt throughout the Willamette Valley, as far south as Eugene (Allen and others, 2009). Within the vicinity of the City, several authors, including Schlicker and Deacon (1967) and Frank and Collins (1978), refer to the fine-grained sediments as Willamette Silt. In this report, we have adopted the name Fine-Grained Missoula Flood Deposits, after more recent mapping by O'Connor and others (2001). In Figure 1, the Fine-Grained Missoula Flood Deposits are mapped as Missoula Flood Deposits.

Additional, more recent geologic units, which appear throughout the project site, and are included on Figure 1, are Landslide Deposits, Floodplain Deposits, and Alluvium of Smaller Streams. The Landslide Deposits were added to the site geologic map based on mapping from SLIDO 3.4 (Burns and Watzig, 2017). Landslide deposits typically consist of a mix of unconsolidated rock, soil, sediment, and colluvium. Only a single landslide deposit was added to the geologic map of the project site in the northeast corner of Figure 1. Within the southern portion of the project site, Holocene and upper Pleistocene Floodplain Deposits are mapped around the Willamette River. These units, which were mapped by O'Connor and Others, 2001, consist of unconsolidated silt, sand, and gravel. This unit incorporates both active channels and modern floodplains. In some areas, this unit can reach 15 meters in

thickness. The Alluvium of Smaller Streams, which is also in the southern section of the project site, is predominantly made up of unconsolidated clay, silt, sand, and some gravel. This unit is differentiated from the Floodplain Deposits based on the size of the stream which deposited it.

2.2.4 Available Mapping

DOGAMI developed a publication based on the Oregon Resilience Plan CSZ scenario for the state of Oregon. The publication, Open-File Report O-13-06, primarily consists of GIS data of site conditions, ground motions, ground deformations, and other hazards associated with a magnitude 9.0 event on the CSZ (Madin and Burns, 2013). Datasets of interest for this project include the following:

- Shear Wave Velocity within 30 meters of the Ground Surface (Vs30)
- Bedrock and Site Peak Ground Acceleration (PGA)
- Bedrock and Site 1-second Spectral Acceleration (SA1)
- Bedrock and Site Peak Ground Velocity (PGV)
- Liquefaction Susceptibility, Probability, and Permanent Ground Deformation (PGD)
- Earthquake-Induced Landslide Susceptibility, Probability, and PGD

The provided methodology indicates that, within the project area, the majority of these datasets were derived based on the Relative Earthquake Hazard Map of the Portland Metro Region (IMS-1; Mabey and others, 1997); the Oregon Geologic Data Compilation Release 5 (OGDC-5; Ma and others, 2009); and the Statewide Landslide Information Database for Oregon Release 2 (SLIDO-2; Burns and others, 2011). The bedrock ground motions included in the publication were provided to DOGAMI by the U. S. Geological Survey (USGS) and are based on the USGS Cascadia M 9.0 scenario ShakeMap®.

Following the publication of O-13-06, DOGAMI published the Oregon Geologic Data Compilation Release 6 (OGDC-6; Smith and Roe, 2015) and Release 3.4 of the Statewide Landslide Information Database for Oregon (SLIDO-3.4; Burns and Watzig, 2017). These recent publications have not yet been incorporated into DOGAMI's CSZ scenario datasets.

Bedrock 0.3-second spectral acceleration data were downloaded from the USGS website for the Cascadia M 9.0 scenario ShakeMap® (USGS, 2011). Data for the 0.2-second spectral acceleration, as used in building codes, were not available. For preliminary planning purposes, the 0.2-second spectral acceleration can be approximated as the 0.3-second spectral acceleration.

2.3 Modifications to Published Geologic Mapping

Our geologic study draws on data from the O-13-06 document which characterizes the geologic hazards for the Cascadia Subduction Zone event, but also incorporates landslide data from SLIDO 3.4 and new geologic information from the OGDC-6. The OGDC dataset combines the best-known geologic mapping of the entire state into a single database. While more recent mapping of the area has been completed, most notably USGS Open-File Report 2018-1044, the digital files were not made available when both DOGAMI and the USGS were contacted. Minor modifications were made to the OGDC-6 layer based on metadata within the file.

Using the OGDC-6 as the geologic base map, we overlaid and added in deposits from SLIDO-3.4 that were not included in the geologic map. Within the entire study area, only a single landslide deposit had to be added in the northeast portion of the study area. The resulting final map is shown on Figure 1.

2.4 Seismic Hazard Maps

The purpose of the maps is to delineate the ground shaking and permanent ground deformation hazard across the service area based on a magnitude 9.0 CSZ earthquake. Ground shaking hazard is delineated in terms of the following:

- Peak ground acceleration (PGA)
- 0.3-second spectral acceleration (SA0.3)
- 1-second spectral acceleration (SA1)
- Peak ground velocity (PGV)

Permanent ground deformation (PGD) hazard is delineated by the following:

- Probability of liquefaction
- Liquefaction-induced lateral spread PGD
- Liquefaction-induced settlement PGD
- Probability of earthquake-induced sliding in both wet and dry conditions
- Landslide-induced PGD in both wet and dry conditions

These maps were derived using the same approach as the published DOGAMI O-13-06 magnitude 9.0 CSZ scenario maps but using more recently published background information and more targeted assumptions about local conditions. We provide maps of the updated information (i.e., most recent geologic map in Figure 1) and maps developed as intermediate steps (i.e., Figure 3, Liquefaction Hazard, and Figures 4 and 5, Landslide Susceptibility in both wet and dry conditions) in deriving the final hazard maps.

Modifications to both the O-13-06 methodology and additional input maps are summarized below.

2.5 Shear Wave Velocity, V_{s30}

For the study area around Newberg, there are published DOGAMI maps which show V_{s30} values. However, because multiple methodologies were used across the area, the data lacks uniformity. Additionally, there are no 3D shear wave velocity models such as exist for the Portland metropolitan area. Therefore, due to the limited availability of V_{s30} data throughout the project study area, values were assigned based on NEHRP site classes. In our opinion, this was the best way to create a unified map. To do this, V_{s30} values from Holzer and others (2005), which are adapted from BSSC (2001), were assigned to each geologic unit based on its site class. In the determination of site classes, both published classes in O-13-06 as well as interpretation of geologic units were used. Both the site class and V_{s30} values assigned to each geologic category are shown below. These values should be considered estimates and assume that the material in the upper 100 feet is uniform.

- Columbia River Basalt: Site Class B, 1130 m/s
- Troutdale and Scappoose Formations: Site Class B/C Boundary, 760 m/s
- Landslide deposits overlying rock: Site Class C, 540 m/s
- Landslide deposits overlying flood deposits: Site Class D, 270 m/s
- Missoula Flood Deposits: Site Class D, 270 m/s
- Floodplain Deposits and Alluvium of Smaller Streams: Site Class D to E, 180 m/s

While some published DOGAMI maps classify landslide deposits as Site Class F, it is our opinion that the deposits do not meet the criteria of Site Class F material, as defined in the Hazus® -MH 2.0 Technical Manual (FEMA, 2011). The final V_{s30} map is shown on Figure 2.

2.6 Liquefaction Hazard

The liquefaction susceptibility map provided in O-13-06 is a compilation of liquefaction susceptibility maps from other DOGAMI publications. Within the Newberg area, this includes both IMS-7 and IMS-24. Explanatory texts for both of these interpretive map series indicate that susceptible units were assumed to be saturated. This was believed to be a conservative approach as the majority of highly liquefiable sediment is restricted to alluvial deposits in areas of low relief and high rainfall. However, comparison of the maps revealed that different methodologies were used to determine liquefaction susceptibility. This meant that susceptibility within the same unit could vary significantly across the boundary between IMS-7 and IMS-24. Therefore, we used our updated geologic map (Figure 1) and employed the Youd and Perkins (1978) methodology, as well as knowledge of regional

liquefaction susceptibility, to assign new liquefaction susceptibilities and create a unified map. The resulting map is shown on Figure 3.

2.7 Landslide Susceptibility

We generally followed the methodology and Geologic Group assignments as described in O-13-06, using the compiled geologic map shown on Figure 1 and discussed above, as the base map. We assigned Geologic Group C (relatively weak material) to areas mapped as Alluvial of Smaller Streams, Missoula Flood Deposits, Floodplain Deposits, and Landslide Deposits. All other geologic units, including Columbia River Basalt, Scappoose Formation, and Troutdale Formation, were assigned Geologic Group B. We calculated a slope map from bare earth lidar data of the area to complete the landslide susceptibility map because DOGAMI's slope map was not included in O-13-06. In order to give what we believe are upper and lower limits of landslide susceptibility, maps accounting for both dry and wet conditions were generated. Dry conditions assume that the groundwater is below the level of sliding, while wet conditions assume that the groundwater level is at ground surface. The landslide susceptibility maps are shown on Figures 4 and 5.

2.8 PGA, SA1, SA0.3, and PGV

The site amplification factors in O-13-06 were calculated based on site class and the appropriate V_{s30} value for each site, as determined when creating the V_{s30} map as described above. We calculated the PGA and SA1 site amplification factors for the Newberg area from the V_{s30} raster described above using the approach referenced in O-13-06 (Boore and Atkinson, 2008) and applied them to the bedrock PGA and SA1 maps provided with O-13-06 to produce PGA, SA1, and PGV maps modified for Site Class.

Maps of Peak Ground Acceleration, 1-Second Spectral Acceleration, and Peak Ground Velocity are shown on Figures 6, 8, and 9, respectively. The same methodology was used for the 0.3-Second Spectral Acceleration map, shown in Figure 7, using the bedrock SA0.3 map from the USGS scenario. It should be noted that current USGS & DOGAMI mapping does not include mapping for the 0.2-second spectral acceleration, but it does include spectral acceleration for a period of 0.3 seconds. For preliminary planning purposes the 0.2-second spectral acceleration can be approximated as the 0.3-second spectral acceleration.

2.9 Probability of Liquefaction

We used the refined liquefaction hazard map described above and followed the methods presented in O-13-06 to develop a map of liquefaction probability. Because we assigned a liquefaction susceptibility of "Low to Moderate" for Missoula Flood Deposits, its P_{ml} value, which is defined as the proportion of a map unit susceptible to liquefaction, had to be

interpreted. Because geologic units with low and moderate susceptibilities have P_{ml} values of 0.05 and 0.1 respectively. Therefore, Missoula Flood Deposits were assigned a P_{ml} of 0.075. The resulting map is shown on Figure 10.

2.10 Liquefaction-Induced PGD

2.10.1 Lateral Spreading

We used the refined liquefaction hazard map described above and followed the methods presented in O-13-06 to calculate permanent ground deformations from liquefaction-induced lateral spreading. The map of estimated PGD due to lateral spreading is included on Figure 11.

2.10.2 Settlement

DOGAMI did not include a map of predicted ground settlement associated with liquefaction in O-13-06. We calculated estimated liquefaction-induced settlements following the methodology in Chapter 4 of the Hazus® -MH 2.0 Technical Manual (FEMA, 2011), using the refined liquefaction hazard map discussed above.

The FEMA method associates each susceptibility category with a unique settlement amplitude value. Each of the values is assumed to have an uncertainty with a uniform probability distribution from one-half to two times the respective value. The map of estimated PGD due to liquefaction-induced settlement is included on Figure 12.

2.11 Probability of Earthquake-Induced Landslides

We used the refined landslide susceptibility and PGA maps described above and followed the methods presented in O-13-06 to calculate and map the probability of earthquake-induced landslides. To give what we believe are upper and lower limits of the probability of earthquake-induced landslides, we calculated probabilities in both wet and dry conditions. This was done by populating tables 4.17 and 4.18 in Chapter 4 of the Hazus® -MH 2.0 Technical Manual (FEMA, 2011). The resulting maps are shown on Figures 13 and 14.

2.12 Earthquake-Induced Landslide PGD

The earthquake-induced landslide PGD map is based on the methodology in Hazus® -MH 2.0 Technical Manual (FEMA, 2011), which is referenced in O-13-06. We retained the acceleration term that DOGAMI chose to remove from FEMA equation 4-25 because the acceleration is in “decimal fraction of g 's,” not cm/sec^2 , as DOGAMI indicated.

Additionally, we observed that the equation given by DOGAMI for the displacement factor did not produce a curve similar to the FEMA Figure 4.14 relationship. In examining the DOGAMI equation, we saw that if the first constant was made negative, a curve similar to the FEMA Figure 4.14 relationship was seen. Therefore, we based our calculations on this slightly amended and corrected relationship to match the source FEMA publication. As we did for all landslide maps, we generated permanent ground deformation maps for both wet and dry conditions. These maps were based on probability inputs generated when calculating the probability of earthquake-induced landslides. Our maps of estimated earthquake-induced landslide permanent ground deformation are shown on Figures 15 and 16.

2.13 Seismic Hazards at Critical Infrastructure

The locations of selected infrastructure have been provided by HDR. The approximate locations of the selected infrastructure are shown on Figures 1 through 16 and a summary of the GIS map results for seismic hazards at these specific locations are shown on an attached Table 1.

3 WATER TREATMENT PLANT SLOPE EVALUATION

3.1 Background

The existing WTP is adjacent to a steep slope that is north of the Willamette River. The site also contains a pipe bridge that extends from the crest of the north slope to the well fields south of the Willamette River. We understand based on existing information that the north slope has had periods of instability. Most notably, a slide occurred along the north slope in the spring of 1996 and was documented in a report prepared by Squier Associates dated June 24, 1999. A repair to the slope consisting of a rock buttress was designed and documented by Squier Associates in a summary report dated June 28, 2002. According to the summary report, the slope repair was completed on October 26, 1999.

An additional slope evaluation was performed by Northwest Geotech, Inc. (NGI), and was documented in a summary letter dated November 8, 2016. According to the findings in the NGI summary letter, recent and historic landslides have been observed along the riverbank near the existing pipe bridge. We understand that there are two inclinometers installed along the north slope. One inclinometer is located near the existing pipe bridge and the other is south of the existing WTP. However, the data from the two inclinometers was not made available at the time of this report.

The approximate location of the WTP site is shown on Figure 17, Vicinity Map and the current explorations and slope stability section are shown on Figure 18.

3.2 Subsurface Conditions

The field exploration program for the project included two geoprobes, designated P-1 and P-2, and two cone penetration tests (CPTs), designated CPT-1 and CPT-2. The approximate locations of the explorations are shown on Figure 18. The explorations were performed on May 20, 2019. The two geoprobes were advanced to depths ranging from 30 to 68 feet and the two CPTs were advanced to depths ranging from 68 to 83 feet below the existing ground surface (bgs). Details of the field explorations, including techniques used to advance and sample the geoprobes and cone penetration tests, are presented in Appendix A, Field Explorations.

We grouped the materials encountered in our field explorations into three geotechnical units, as described below. This interpretation of the subsurface conditions is based on the explorations and regional geologic information from published sources. The geological units are as follows:

- **Fill:** Silty Gravel with Sand (GM) to Silt with Sand (ML), wood debris also encountered;
- **Fine-Grained Missoula Flood Deposits:** Silt (ML), Silt with Sand (ML), Sandy Silt (ML), Silty Sand (SM), Lean Clay (CL), Fat Clay (CH); and
- **Hillsboro Formation:** Fat Clay (CH).

These geological units were grouped based on their engineering properties, geologic origins, and distribution in the subsurface.

3.3 Groundwater

The depth to groundwater was estimated from a dissipation test performed within CPT-1. According to the results of the dissipation test, the depth to groundwater is approximately 35 feet bgs.

3.4 Seismic and Geologic Hazards

The seismic hazard evaluation for this project was conducted in accordance with the American Society of Civil Engineer's (ASCE) Minimum Design Loads for Buildings and Other Structures, 2016 Edition (ASCE 7-16), which is based on earthquake ground motions with a 2,475-year return period.

3.5 Strong Ground Motion

ASCE 7-16 requires that geotechnical hazard analyses (liquefaction, specifically) be performed for Maximum Considered Earthquake Geometric Mean (MCE_G) ground motions and adjusted for site class effects. Specifically, the peak ground acceleration used in the liquefaction-related hazard analyses, PGA_M , is defined as:

Exhibit 1: Site-Adjusted Peak Ground Acceleration

Equation	Variable and Definition
$PGA_M = F_{PGA} \times PGA$	PGA_M MCE_G Peak Ground Acceleration Adjusted for Site Class Effects
	F_{PGA} Site Coefficient from ASCE 7-16 Table 11.8-1
	PGA MCE_G Peak Ground Acceleration of Site Class B/C Boundary Conditions

Reference: ASCE 7-16, Equation 11.8-1

For this project, we obtained a PGA_M of 0.474g using a PGA of 0.392g and an F_{PGA} of 1.208. PGA is shown in ASCE 7-16 Figure 22-9 and is derived from the most recent USGS National Seismic Hazard Mapping Project ground motion hazard analyses results by Petersen and others (2014). F_{PGA} is a function of site class and PGA as indicated in ASCE 7-16 Table 11.8-1. The shear wave velocities measured in CPT-1 correspond to Site Class D.

3.6 Liquefaction

Liquefaction is a phenomenon in which excess pore pressure of loose to medium dense, saturated, nonplastic to low plasticity silts and granular soils increases during ground shaking. The increase in excess pore pressure results in a reduction of soil shear strength and a quicksand-like condition.

Soil behavior under seismic loading is the primary factor in determining the susceptibility of a soil to liquefaction. Important factors in evaluating soil behavior are relative density, the fines content (percent of soil by weight smaller than 0.075 millimeter, passing the No. 200 sieve), and the plasticity characteristics of the fines. Relative density is estimated based on methods including Standard Penetration Test (SPT) N-values, CPT tip resistances, and shear wave velocity.

The second major component of a liquefaction study is the design earthquake motions. Seismogenic sources that contribute to the seismic hazards at the site include the CSZ interface, CSZ Benioff zone, and local shallow crustal faults. Because the maximum earthquake magnitudes for sources vary significantly, we used a mean maximum magnitude of 7.5 for ground motions with a 2,475-year return period for liquefaction analyses.

3.7 Liquefaction Analysis and Liquefaction-Induced Settlement

Shannon & Wilson evaluated liquefaction potential of the soils by performing liquefaction analyses on the CPTs using the Boulanger and Idriss (2014) method. The liquefaction analysis for CPT soundings was accomplished using the computer program CLiq Version 2 by GeoLogismiki, which incorporates the Boulanger and Idriss (2014) method. Shannon & Wilson used the ground motion parameters described above (i.e., PGA of 0.474g at the surface and moment magnitude 7.5). Soil layers identified as potentially liquefiable in the explorations are summarized in Exhibit 2.

Exhibit 2: Summary of Liquefaction-Induced Settlement

Location	Approximate Ground Surface Elevation (feet)	Approximate Groundwater Elevation (feet)	Approximate Liquefiable Layer Depth (feet)	Approximate Settlement at Ground Surface (inches)
CPT-1	170	135	35 to 45	1.5
CPT-2	170	135	36 to 46	1

Exhibit 2 also presents total estimated liquefaction-induced settlement at the ground surface. Liquefaction-induced settlement magnitudes based on CPT soundings were estimated using Zhang et al. (2002).

3.8 Lateral Spreading

Lateral spreading hazards can exist in areas with mild slopes adjacent to a much steeper slope or vertical face. Lateral spreading failure can occur if soil liquefaction develops during a seismic event and the ground acceleration (inertial force) briefly surpasses the yield acceleration (shear strength) of the liquefied soil. This can cause both the liquefied soil and an overlying non-liquefied crust of soil to displace laterally down mild slopes or towards an embankment face. The displacements are cumulative and permanent in nature.

Shannon & Wilson performed a preliminary screening of lateral spreading hazards at the site using the Zhang et al. (2004) methodology. The results of the Zhang et al. (2004) analyses at the project site indicate lateral spread displacements may be up to approximately 2 feet at a distance of approximately 300 feet from the crest of the slope, which would impact existing infrastructure at the WTP site. More accurate assessments of the liquefaction-related hazards present at the site may be made using non-linear time history numerical models that explicitly model the buildup of excess pore water pressure in the soil and associated soil strain (e.g. 2-dimensional FLAC analyses). However, these analyses are beyond the scope of this project.

3.9 Slope Stability

We performed a slope stability analysis at one cross-section through the slope adjacent to the existing pipe bridge, based on available topographic information (i.e. LiDAR), and our subsurface explorations. The subsurface groundwater was based on the water level estimated from our CPT explorations and the water level within the Willamette River was based on the gage height measured from the nearest river gage. Also, the riverbed elevation was estimated from a USGS bathymetric survey performed in 2002.

3.9.1 Approach

Slope stability is influenced by various factors, including the following: (1) the geometry of the soil mass and subsurface materials; (2) the weight of soil materials overlying a potential failure surface; (3) the shear strength of soils and/or rock along a potential failure surface; and (4) the hydrostatic pressure (groundwater levels) present within the soil mass and along a potential failure surface.

The stability of a slope can be expressed in terms of a factor of safety, which is defined as the ratio of resisting forces to driving forces. At equilibrium, the factor of safety is equal to 1.0, and the driving forces are balanced by the resisting forces. Slope movement is predicted when the driving forces exceed the resisting forces, i.e., the factor of safety is less than 1.0.

An increase in the factor of safety greater than 1.0, whether by increasing the resisting forces or decreasing the driving forces, reflects a corresponding increase in the stability of the mass. The actual factor of safety may differ from the calculated factor of safety, due to variations or uncertainty in the soil strength, subsurface geometry, potential failure surface location and orientation, groundwater level, and other factors that are not completely known.

Shannon & Wilson performed the slope stability analysis using the computer program SLOPE/W, Version 10.0.0.17401 (Geo Slope International, 2018). The Morgenstern-Price method was used for rotational and irregular surface failure mechanisms. We utilized information from the closest explorations to estimate material strength and unit weight parameters for the geologic units assumed to underlie the slope. Specifically, strength correlations based on the CPTs were used. Liquefied strength parameters were developed from CPT correlations.

The slope stability was evaluated for the static, seismic, and post-seismic (liquefied soil) conditions. See discussions of these various conditions below and Exhibit 3 for tabulations of the results of our slope stability analyses.

3.9.2 Static

For slopes supporting or impacting essential facilities, a minimum factor of safety of 1.5 is recommended for the static condition.

3.9.3 Seismic

A minimum factor of safety of 1.1 is recommended for the seismic case. Shannon & Wilson performed pseudo-static analyses to evaluate the seismic slope stability using a horizontal seismic coefficient of 0.237, which is equal to one-half of the PG_{AM} . If the factor of safety of the critical failure surface was less than 1.1, potential displacements were estimated using the procedures in the National Cooperative Highway Research Program (NCHRP) document NCHRP 611 (NCHRP, 2008).

3.9.4 Post-Seismic

A minimum factor of safety of 1.1 is recommended for the post-seismic (liquefied) condition. A failure surface with a factor of safety less than 1.1 indicates the potential for a flow failure caused by a loss of strength within a liquefied soil layer. A flow failure is initiated when a shear failure occurs along a failure surface and is often characterized by large rapid ground movement of the soil mass inside the failure zone.

3.9.5 Results of the Slope Stability Analysis

We evaluated the stability of the slope for static, seismic, and post-seismic conditions. Based on our analysis, the slope is marginally stable under static conditions and is not stable in seismic or post-seismic conditions. The slope stability results are summarized in Exhibit 3 and plots of the results are shown in Appendix B.

Exhibit 3: Summary of Slope Stability Results

Condition	Factor of Safety
Static	1.02
Seismic	0.65
Post-Seismic	0.75

Stability analyses performed for the seismic and post-seismic case indicated that the slope had a factor of safety less than 1.1. Therefore, based on the results, seismically induced displacements and/or flow failures could occur at this site during and after a seismic event. As mentioned previously, lateral spreading (i.e. flow failure) displacements could be in the range of approximately 2 feet at a distance of approximately 300 feet from the crest of the slope. Seismically induced ground deformations using the methods outlined in NCHRP (2008) could be in the range of approximately 7.5 feet.

4 LIMITATIONS

This report, data collection, and hazard mapping has been completed for the exclusive use of HDR, Inc., and the City of Newberg for specific application to the Water System Seismic Resiliency project.

No interpretations between exploration locations are included in this report. The interpretations, conclusions, and recommendations that are contained in this report were prepared in accordance with generally accepted professional geotechnical engineering principles and practices in this area at the time this report was prepared. We make no warranty, either express or implied.

The scope of our geotechnical services described in this report has not included an environmental evaluation regarding the presence or absence of hazardous or toxic materials in the soil, surface water, groundwater, or air, on or below the site for evaluation or disposal of contaminated soils or groundwater, should they be encountered, except as noted in this report.

The subsurface explorations were performed to characterize soil conditions at limited locations at the site and our observations are specific to the locations and depths noted on the explorations and in this report. No amount of subsurface exploration can precisely predict the characteristics, quality, or distribution of subsurface site conditions. Potential variation includes but is not limited to the following: varying conditions between borings, changes to the site and subsurface conditions due to the passage of time or intervening causes (natural and manmade), and seasonal or recharge source-influenced fluctuations of groundwater conditions.

Shannon & Wilson has prepared a document, "Important Information About Your Geotechnical/Environmental Report," to assist you and others in understanding the use and limitations of this document. This document is attached to the end of this report.

5 REFERENCES

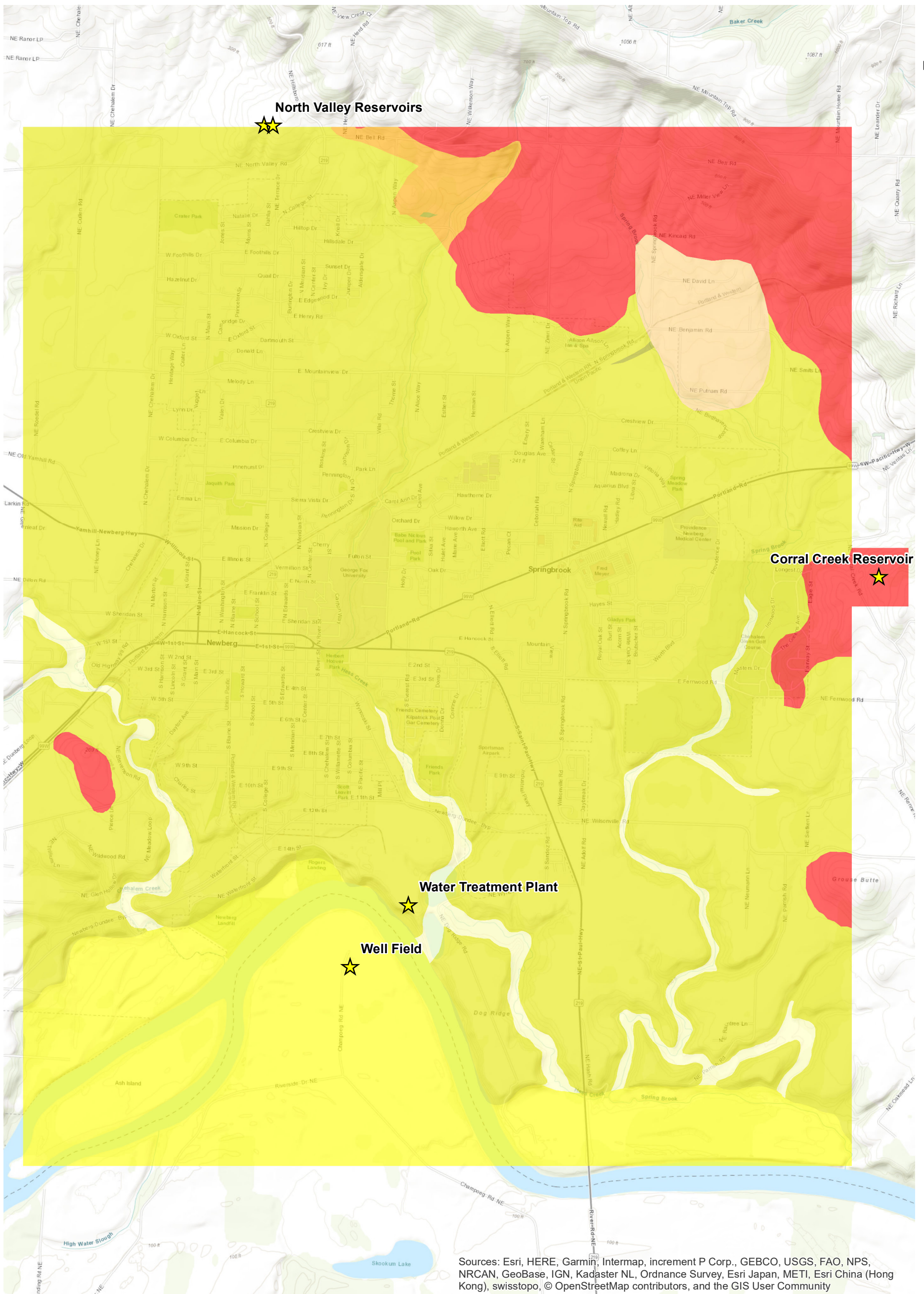
- Allen, J.E., Burns, M., and Burns, S., 2009, *Cataclysms on the Columbia: The Great Missoula Floods* (2nd ed.): Portland, Oregon, Ooligan Press, 204 p.
- American Society of Civil Engineers, 2017, *Minimum design loads and associated criteria for buildings and other structures*: Reston, Va. American Society of Civil Engineers, ASCE Standard ASCE/SEI 7-16, 2 v.
- Boore, D. M. and Atkinson, G. M., 2008, Ground-motion prediction equations for the average horizontal component of PGA, PGV, and 5%-damped PSA at spectral periods between 0.01 s and 10.0 s: *Earthquake Spectra*, v. 24, no. 1, p. 99-138.
- Burns, S., Growney, L., Brodersen, B., Yeats, R.S., and Popowski, T.A., 1997, *Map showing faults, bedrock geology, and sediment thickness of the western half of the Oregon City 1:100,000 quadrangle, Washington, Multnomah, Clackamas, and Marion Counties, Oregon*: Oregon Department of Geology and Mineral Industries Interpretive Map Series IMS-4.
- Burns, W. J.; Mickelson, K. A.; and Saint-Pierre, Evan C., 2011, *Statewide landslide information database for Oregon, release 2 (SLIDO-2)*: Oregon Department of Geology and Mineral Industries Digital Data Series SLIDO-2, scale 1:750,000.
- Burns, W.J., and Watzig, R.J., 2017, *Statewide landslide information database for Oregon, release 3.4 (SLIDO-3.4)*: Oregon Department of Geology and Mineral Industries Digital Data Series SLIDO-3.4, scale 1:750,000.
- Boulanger, R. W. and Idriss, I. M., 2014, *CPT and SPT-based liquefaction triggering procedures*: Davis, Calif., University of California Davis, Center for Geotechnical Modeling, report UCD/CGM-14/01, 134 p.
- Federal Emergency Management Administration, 2011, *HAZUS-MH Technical Manual, Release 2.0*.
- Frank, F. J., and Collins, C. A. (1978). *Groundwater in the Newberg Area, Northern Willamette Valley, Oregon*: United States Department of the Interior Geological Survey, Ground Water Report No. 27.
- Geo-Slope International, 2018, *SLOPE/W 2018*: Calgary, Alberta, Geo-Slope International.
- Holzer, T. L.; Bennett, M. J.; Noce, T. E.; and Tinsley, J. C., 2005, Shear-wave velocity of surficial geologic sediments in northern California: statistical distributions and depth dependence: *Earthquake Spectra*, v. 21, no. 1, p. 161-177.

- Ishihara, Kenji and Yoshimine, Mitsutoshi, 1992, Evaluation of settlements in sand deposits following liquefaction during earthquakes: *Soils and Foundations*, v. 32, no. 1, p. 173-188.
- Ma, L., Madin, I.P., Olson, K.V., and Watzig, R.J., 2009, Oregon Geologic Data Compilation, Release 5: Oregon Department of Geology and Mineral Industries, OGDC-5.
- Madin, I.P., 1990, Earthquake-hazard geology maps of the Portland Metropolitan Area, Oregon: Oregon Department of Geology and Mineral Industries, Open-File Report O-90-2, scale 1:63,360.
- Madin, I.P., and Burns, W.J., 2013, Ground Motion, Ground Deformation, Tsunami Inundation, Coseismic Subsidence, and Damage Potential Maps for the 2012 Oregon Resilience Plan for Cascadia Subduction Zone Earthquakes: Oregon Department of Geology and Mineral Industries, Open-File Report O-2013-06.
- Mabey, M., Black, G.L., Madin, I.P., Meier, D.B., Youd, T.L., Jones, C.F., and Rice, J.B., 1997, Relative Earthquake Hazard Map of the Portland Metro Region, Clackamas, Multnomah, and Washington Counties, Oregon: Oregon Department of Geology and Mineral Industries, Interpretive Map Series IMS-1, scale 1:216,000.
- National Highway Cooperative Research Board, 2008, Seismic Analysis and Design of Retaining Walls, Buried Structures, Slopes, and Embankments: Transportation Research Board, Document 611.
- O'Connor, J.E., Sarna-Wojcicki, A., Wozniak, K.C., Polette, D.J., and Fleck, R.J., 2001, Origin, Extent, and Thickness of Quaternary Geologic Units in the Willamette Valley, Oregon: U.S. Geological Survey Professional Paper 1620.
- Oregon Seismic Safety Policy Advisory Commission (OSSPAC), 2013, The Oregon Resilience Plan.
- Orr, E.L., Orr, W.N., and Baldwin, E.M., 1992, *Geology of Oregon* (4th ed.): Dubuque, Iowa, Kendall/Hunt Publishing Co., 254 p.
- Petersen, M. D.; Moschetti, M. P.; Powers, P. M.; and others, 2014, Documentation for the 2014 update of the United States national seismic hazard maps: U.S. Geological Survey Open-File Report 2014-1091, 243 p.
- Schlicker, H.G. and Deacon, R.J., 1967, Engineering Geology of the Tualatin Valley region, Oregon: Oregon Department of Geology and Mineral Industries Bulletin B-60, 103 p., 5 app., 45 figs., 5 tables, 4 pls., scale 1:48,000.
- Smith, R.L., and Roe, W.P., 2015, Oregon Geologic Data Compilation, Release 6: Oregon Department of Geology and Mineral Industries, OGDC-6.

- Wells, R.E., Weaver, C.S., and Blakely, R.J., 1998, Fore-arc migration in Cascadia and its neotectonic significance: *Geology*, 26, p. 759-762.
- Wells, R.E., Haugerud, R., Niem, A., Niem, W., Ma, L., Madin, I., and Evarts, R., 2018, New geologic mapping of the northwestern Willamette Valley, Oregon, and its American Viticultural Areas (AVAs)—A foundation for understanding their terroir: U.S. Geological Survey Open-File Report 2018-1044, <https://doi.org/10.3133/ofr20181044>.
- Wilson, D.C., 1998, Post-middle Miocene geologic evolution of the Tualatin Basin, Oregon: *Oregon Geology*, v. 60, no. 5.
- Youd, T.L., and Perkins, D.M., 1978, Mapping Liquefaction-Induced Ground Failure Potential: *Journal of the Geotechnical Engineering Division*, Volume 104, Issue 4, p. 433-446.
- Zhang, G., Robertson, P.K., Brachman, R.W.I., 2002, Estimating liquefaction-induced ground settlements from CPT for level ground, *Canadian Geotechnical Journal*.
- Zhang, G., Robertson, P.K., Brachman, R.W.I., 2004, Estimating liquefaction-induced lateral displacements using the standard penetration test or cone penetration test, *Journal of Geotechnical and Geoenvironmental Engineering*.

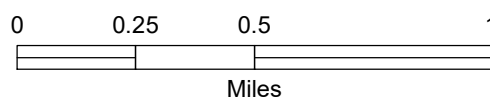
Table 1 - Seismic Hazards Mapped at Selected Infrastructure Locations

Locations	Site Class	PGA (g)	0.3-Second SA (g)	1-Second SA (g)	Liquefaction- Induced Settlement (inches)	Liquefaction- Induced Lateral Spreading (inches)	Earthquake- Induced Landslide PGD (Wet) (feet)
North Valley Reservoir #1	D	0.163	0.486	0.301	0.5-1.5	0-0.1	~2 near slope 150 feet from reservoir
North Valley Reservoir #2			0.482				
Water Treatment Plant	D	0.163	0.599	0.297	0.5-1.5	~16 near slope 120 feet from plant	~20 near slope 120 feet from plant
Corral Creek Reservoir	B	0.133	0.251	0.107	0	0-0.1	~0.5 near slope 100 feet from reservoir



Sources: Esri, HERE, Garmin, Intermap, increment P Corp., GEBCO, USGS, FAO, NPS, NRCAN, GeoBase, IGN, Kadaster NL, Ordnance Survey, Esri Japan, METI, Esri China (Hong Kong), swisstopo, © OpenStreetMap contributors, and the GIS User Community

LEGEND



★ City Properties

Map Unit Name

- Alluvium of smaller streams
- Floodplain deposits
- Landslide deposits
- Missoula Flood Deposits
- Troutdale Formation
- Scappoose Formation
- Columbia River Basalt Group

NOTES

1. Geologic mapping modified from DOGAMI publications OGDC-6 and SLIDO-3.4. See text for details.

City of Newberg Seismic Resiliency
Yamhill County, Oregon

GEOLOGIC MAP

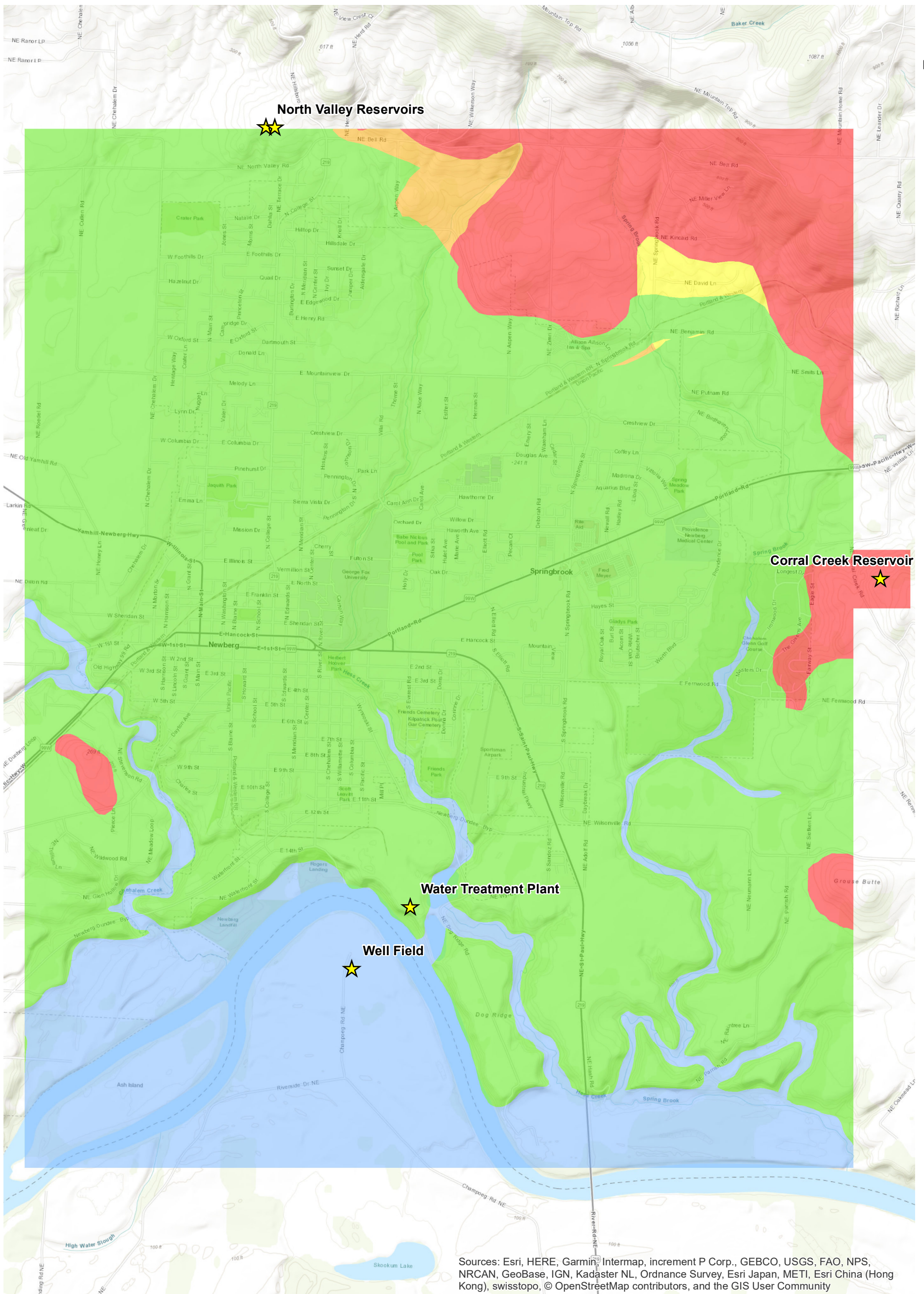
July 2020

101895

SHANNON & WILSON, INC.
GEOTECHNICAL AND ENVIRONMENTAL CONSULTANTS

FIG. 1

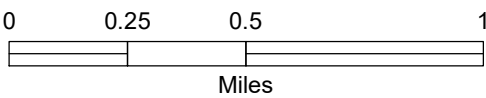
FIG. 1



Sources: Esri, HERE, Garmin, Intermap, increment P Corp., GEBCO, USGS, FAO, NPS, NRCAN, GeoBase, IGN, Kadaster NL, Ordnance Survey, Esri Japan, METI, Esri China (Hong Kong), swisstopo, © OpenStreetMap contributors, and the GIS User Community

LEGEND

- ★ City Properties
- Shear Wave Velocity, Vs30 (m/s)**
- 180
- 270
- 540
- 760
- 1130



NOTES

1. Vs30 based on NEHRP site class and estimated from geologic descriptions. See text for details.

City of Newberg Seismic Resiliency
Yamhill County, Oregon

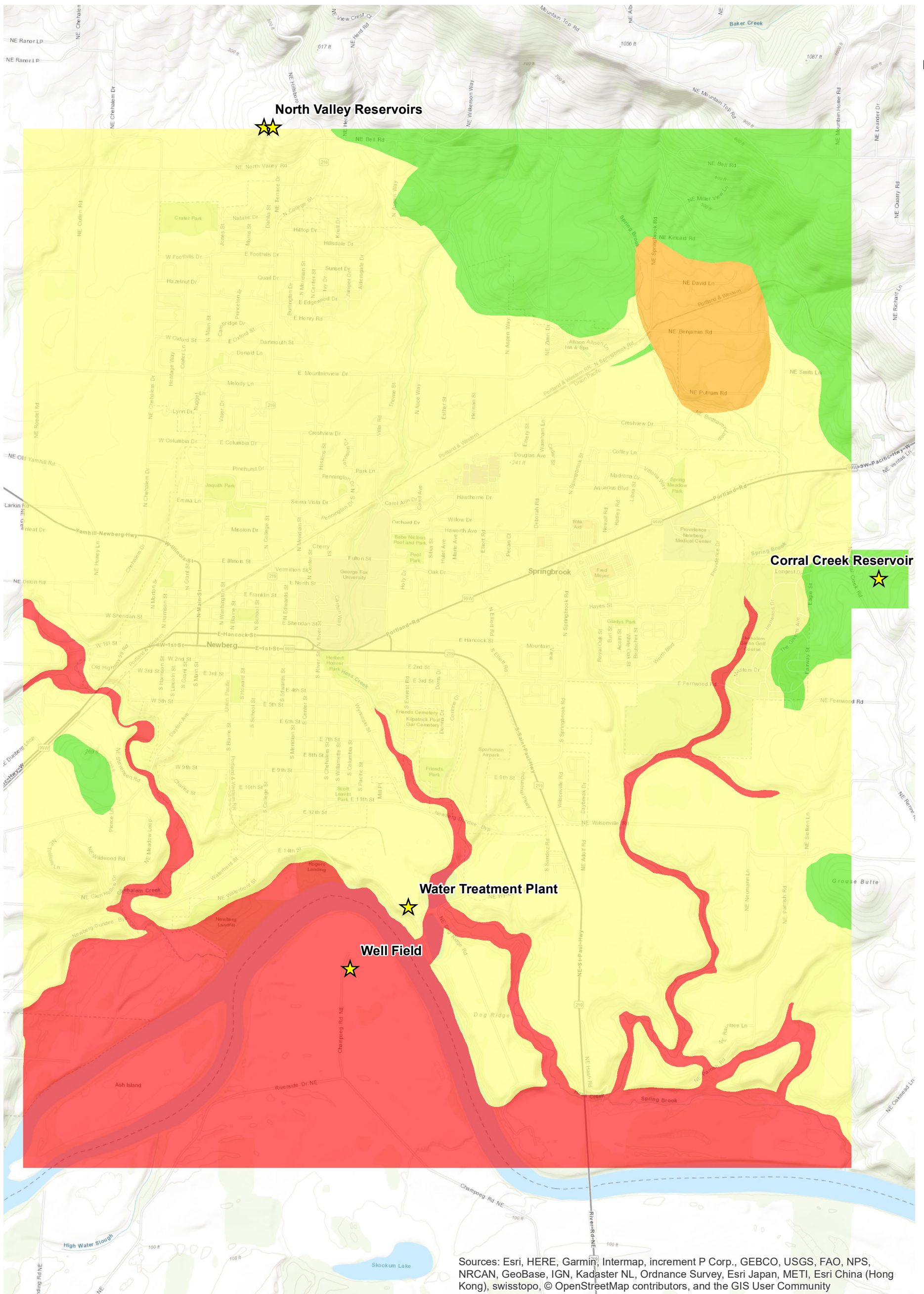
Shear Wave Velocity, Vs 30

July 2020 101895

SHANNON & WILSON, INC.
GEOTECHNICAL AND ENVIRONMENTAL CONSULTANTS

FIG. 2

FIG. 2



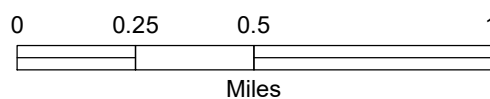
Sources: Esri, HERE, Garmin, Intermap, increment P Corp., GEBCO, USGS, FAO, NPS, NRCAN, GeoBase, IGN, Kadaster NL, Ordnance Survey, Esri Japan, METI, Esri China (Hong Kong), swisstopo, © OpenStreetMap contributors, and the GIS User Community

LEGEND

★ City Properties

Liquefaction Hazard

- Very Low
- Low to Moderate
- Moderate
- High



NOTES

1. Liquefaction hazard map developed from data provided with DOGAMI publication OGDC-6, the Youd and Perkins, 1978 methodology, and knowledge of regional liquefaction hazards.

City of Newberg Seismic Resiliency
Yamhill County, Oregon

LIQUEFACTION HAZARD

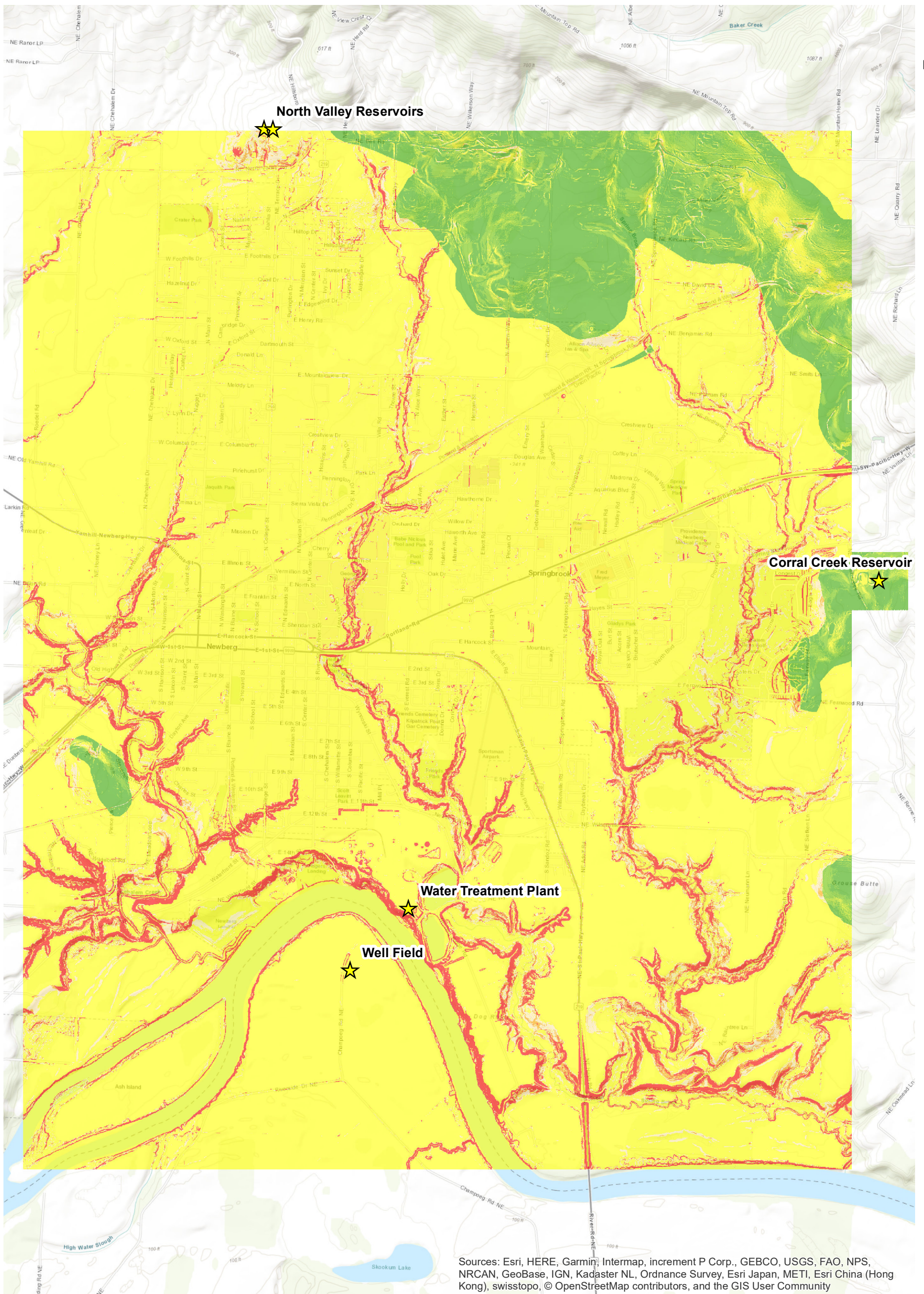
July 2020

101895

SHANNON & WILSON, INC.
GEOTECHNICAL AND ENVIRONMENTAL CONSULTANTS

FIG. 3

FIG. 3



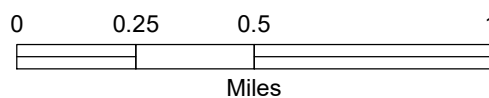
Sources: Esri, HERE, Garmin; Intermap, increment P Corp., GEBCO, USGS, FAO, NPS, NRCAN, GeoBase, IGN, Kadaster NL, Ordnance Survey, Esri Japan, METI, Esri China (Hong Kong), swisstopo, © OpenStreetMap contributors, and the GIS User Community

LEGEND

Landslide Susceptibility in Dry Conditions
(Scale of 0 - 10)



★ City Properties



NOTES

1. Landslide susceptibility calculated from data provided with DOGAMI publications SLIDO-3.4, O-12-02, OGDC-6 and LiDAR. Methodology taken from HAZUS. See text for details.

City of Newberg Seismic Resiliency
Yamhill County, Oregon

**LANDSLIDE SUSCEPTIBILITY
(DRY CONDITIONS)**

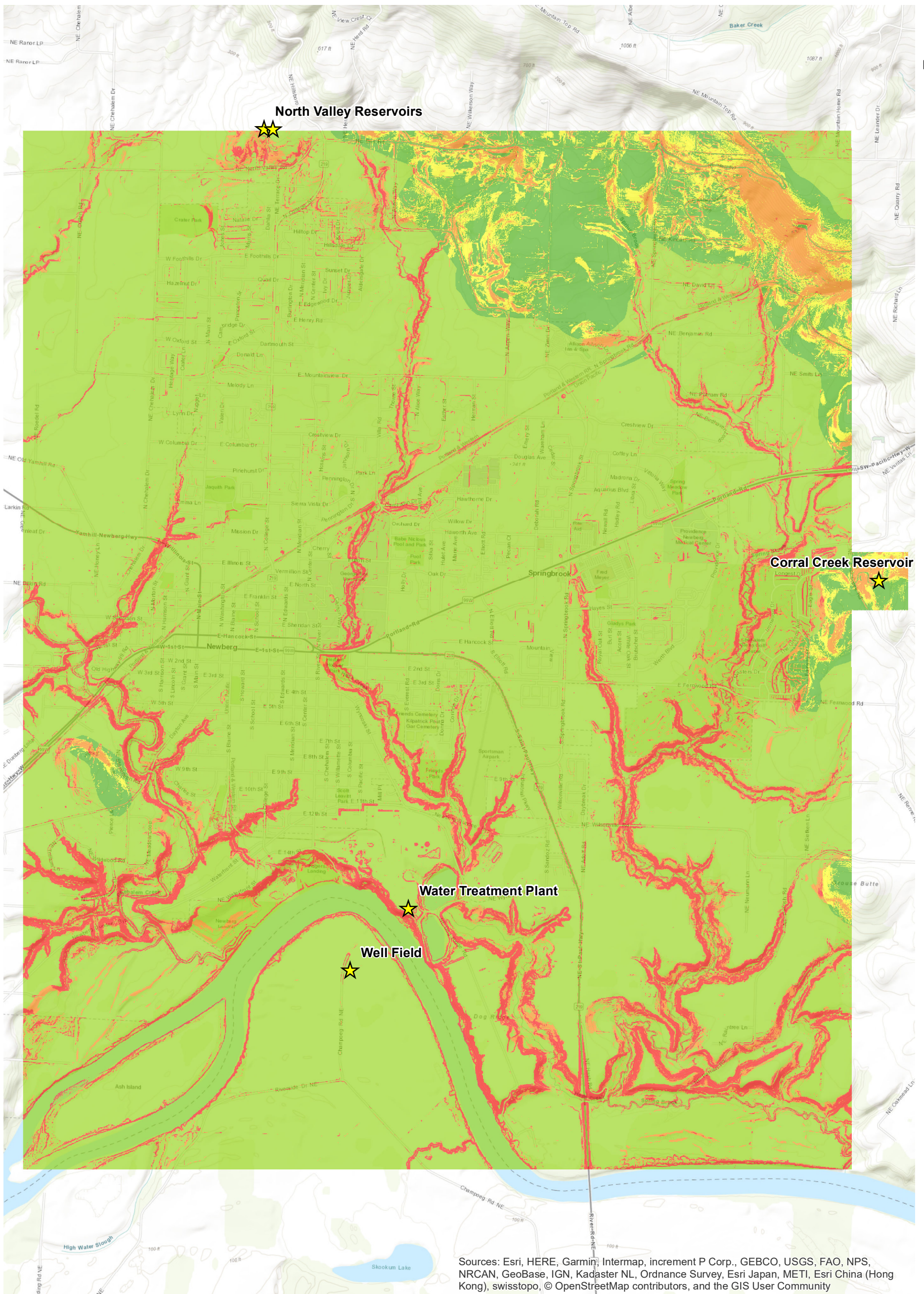
July 2020

101895

SHANNON & WILSON, INC.
GEOTECHNICAL AND ENVIRONMENTAL CONSULTANTS

FIG. 4

FIG. 4



Sources: Esri, HERE, Garmin; Intermap, increment P Corp., GEBCO, USGS, FAO, NPS, NRCAN, GeoBase, IGN, Kadaster NL, Ordnance Survey, Esri Japan, METI, Esri China (Hong Kong), swisstopo, © OpenStreetMap contributors, and the GIS User Community

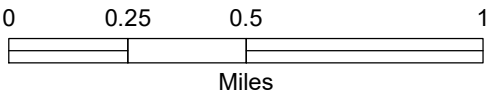
LEGEND

Landslide Susceptibility in Wet Conditions

(Scale of 0 - 10)



★ City Properties



NOTES

1. Landslide susceptibility calculated from data provided with DOGAMI publications SLIDO-3.4, O-12-02, OGDC-6 and LiDAR. Methodology taken from HAZUS. See text for details.

City of Newberg Seismic Resiliency
Yamhill County, Oregon

**LANDSLIDE SUSCEPTIBILITY
(WET CONDITIONS)**

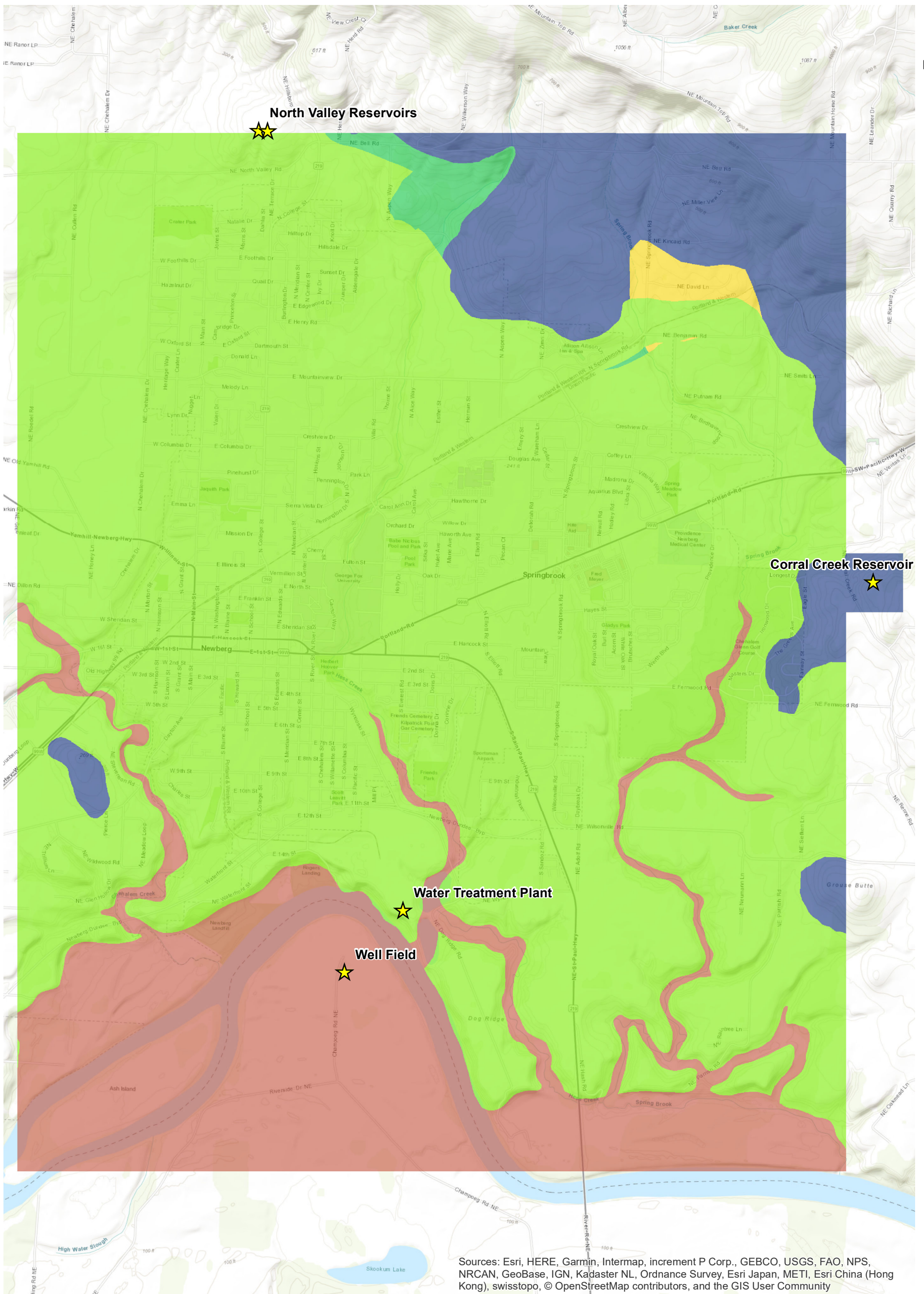
July 2020

101895

SHANNON & WILSON, INC.
GEOTECHNICAL AND ENVIRONMENTAL CONSULTANTS

FIG. 5

FIG. 5

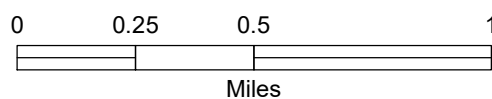


Sources: Esri, HERE, Garmin, Intermap, increment P Corp., GEBCO, USGS, FAO, NPS, NRCAN, GeoBase, IGN, Kadaster NL, Ordnance Survey, Esri Japan, METI, Esri China (Hong Kong), swisstopo, © OpenStreetMap contributors, and the GIS User Community

LEGEND

Site PGA (g)	0.16 - 0.17
0.13 - 0.14	0.17 - 0.18
0.14 - 0.15	0.18 - 0.19
0.15 - 0.16	0.19 - 0.2

★ City Properties



NOTES

1. PGA map for the magnitude 9.0 Cascadia Earthquake Scenario calculated from data provided in DOGAMI publication O-13-06 and methodology in Boore and Atkinson, 2008. See text for details.

City of Newberg Seismic Resiliency
Yamhill County, Oregon

PEAK GROUND ACCELERATION, PGA

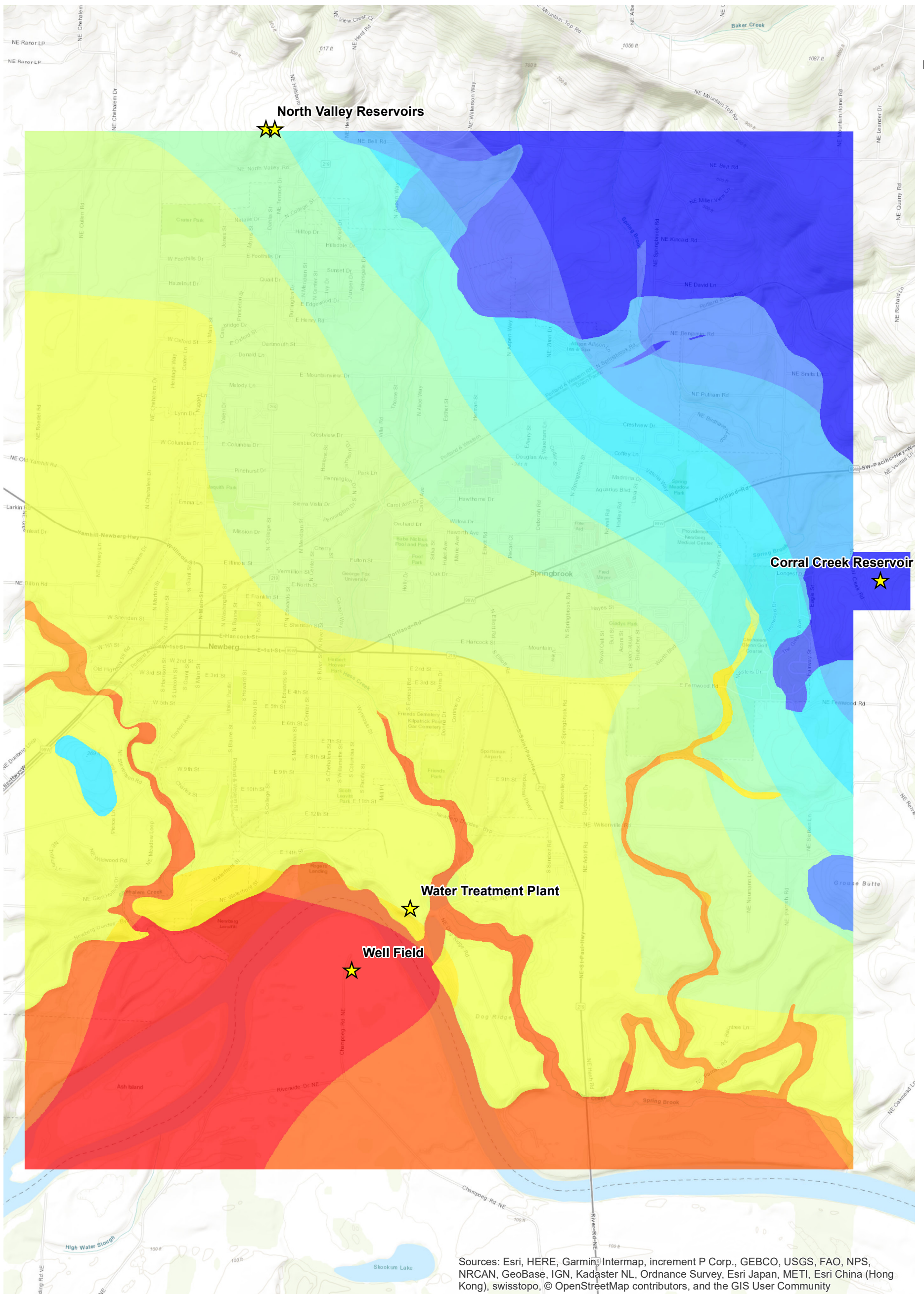
July 2020

101895

SHANNON & WILSON, INC.
GEOTECHNICAL AND ENVIRONMENTAL CONSULTANTS

FIG. 6

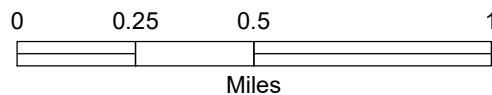
FIG. 6



Sources: Esri, HERE, Garmin, Intermap, increment P Corp., GEBCO, USGS, FAO, NPS, NRCAN, GeoBase, IGN, Kadaster NL, Ordnance Survey, Esri Japan, METI, Esri China (Hong Kong), swisstopo, © OpenStreetMap contributors, and the GIS User Community

LEGEND

★ City Properties	0.36 - 0.4	0.6 - 0.64
Site SA 0.3 (g)	0.4 - 0.44	0.64 - 0.68
0.24 - 0.28	0.44 - 0.48	0.68 - 0.72
0.28 - 0.32	0.48 - 0.52	0.72 - 0.76
0.32 - 0.36	0.52 - 0.56	0.76 - 0.8
	0.56 - 0.6	



NOTES

1. SA0.3 map for the magnitude 9.0 Cascadia Earthquake Scenario calculated from data provided with the USGS Scenario published September 20, 2011, and DOGAMI publications O-12-02 and OGDC-6. See text for details.

City of Newberg Seismic Resiliency
Yamhill County, Oregon

**0.3-SECOND SPECTRAL
ACCELERATION, SA0.3**

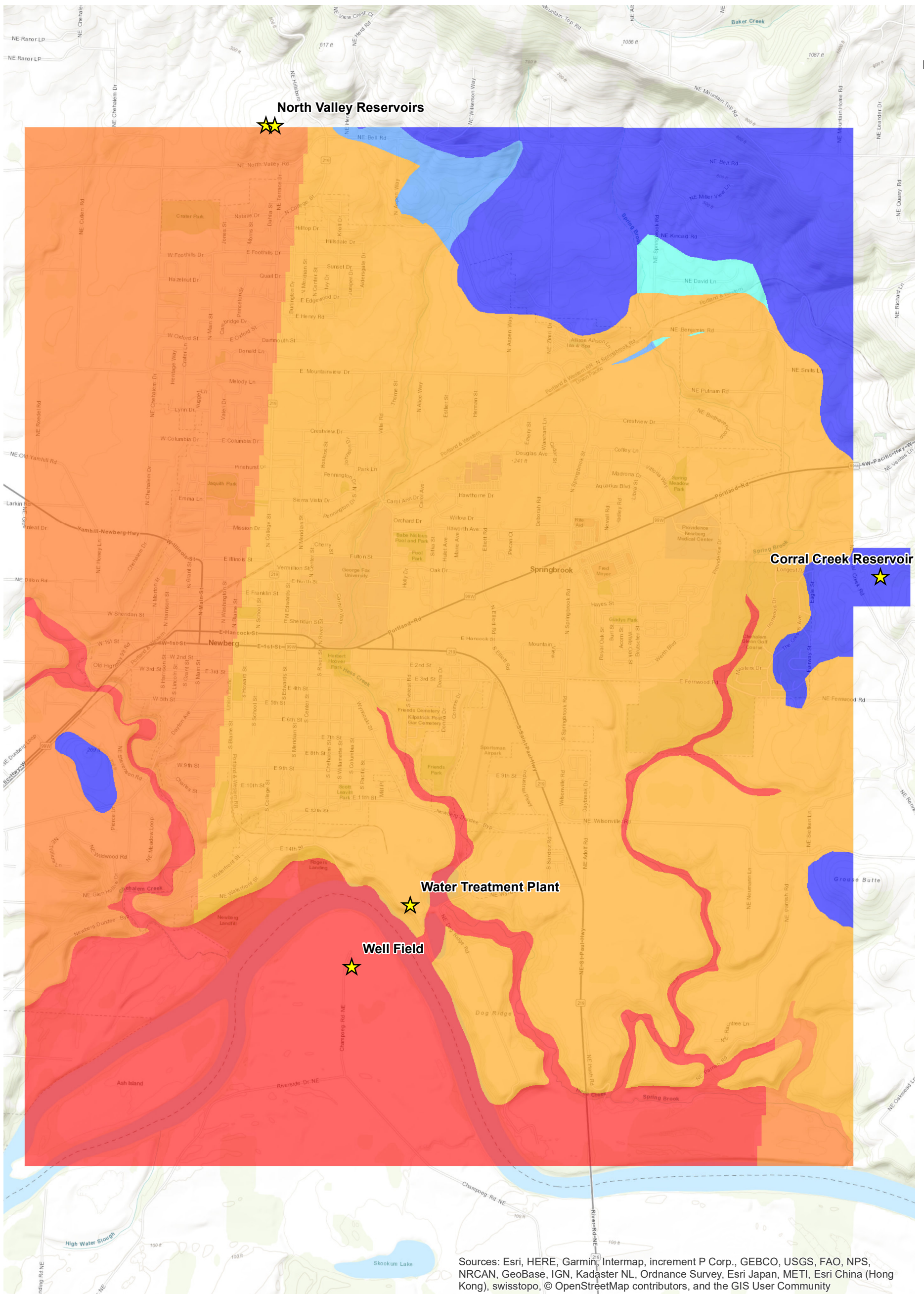
July 2020

101895

SHANNON & WILSON, INC.
GEOTECHNICAL AND ENVIRONMENTAL CONSULTANTS

FIG. 7

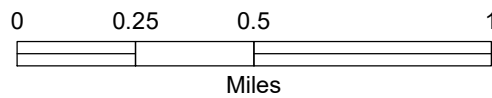
FIG. 7



Sources: Esri, HERE, Garmin, Intermap, increment P Corp., GEBCO, USGS, FAO, NPS, NRCAN, GeoBase, IGN, Kadaster NL, Ordnance Survey, Esri Japan, METI, Esri China (Hong Kong), swisstopo, © OpenStreetMap contributors, and the GIS User Community

LEGEND

- ★ City Properties
- 0.2 - 0.22
- 0.22 - 0.24
- 0.24 - 0.26
- 0.26 - 0.28
- 0.28 - 0.3
- 0.3 - 0.32
- 0.32 - 0.34
- 0.10 - 0.12
- 0.12 - 0.14
- 0.14 - 0.16
- 0.16 - 0.18
- 0.18 - 0.2



NOTES

- SA1 map for the magnitude 9.0 Cascadia Earthquake Scenario calculated from data provided in DOGAMI publications O-13-06 and OGDC-6, and methodology in Boore and Atkinson, 2008. See text for details.

City of Newberg Seismic Resiliency
Yamhill County, Oregon

**1-SECOND SPECTRAL
ACCELERATION, SA1**

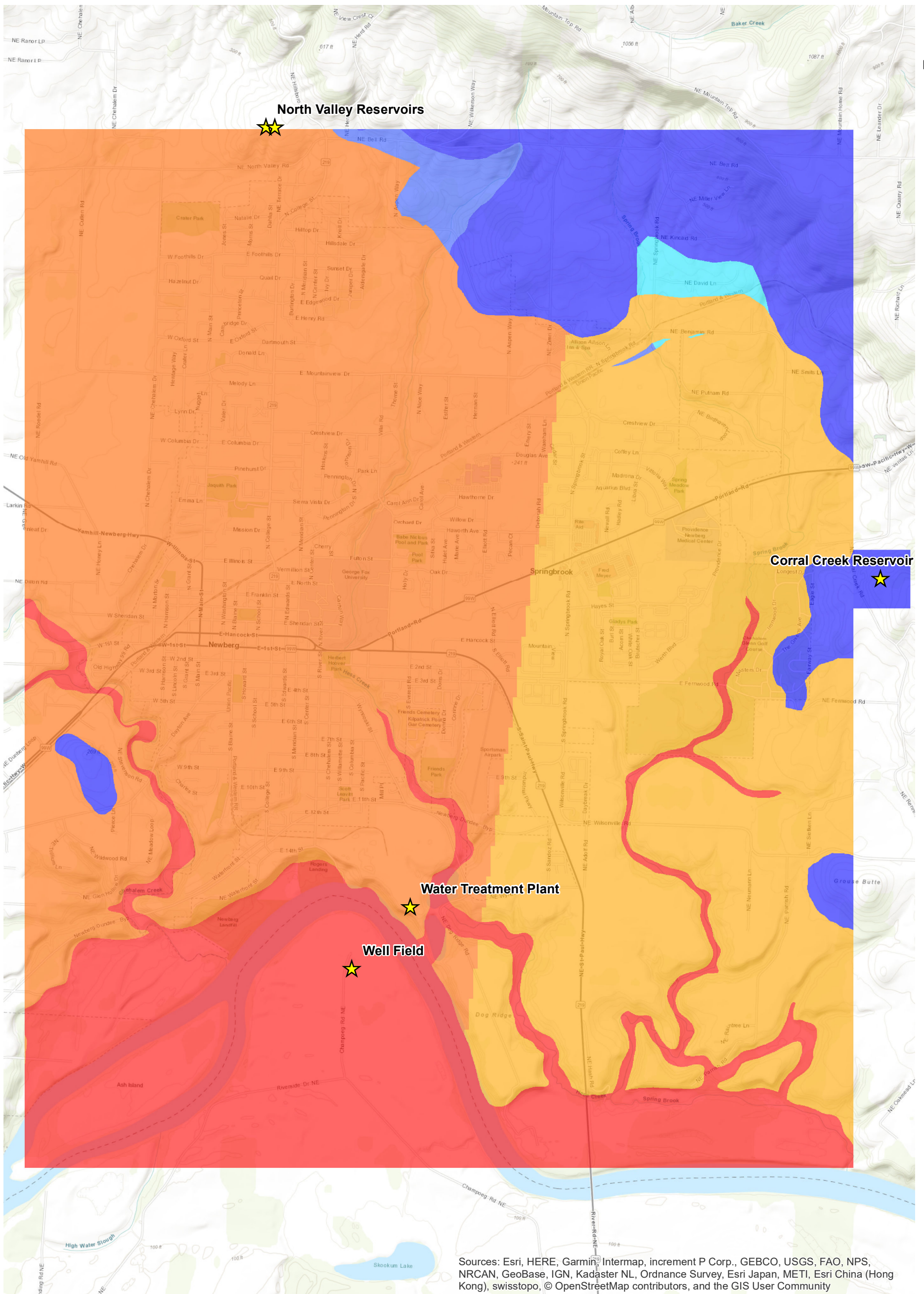
July 2020

101895

SHANNON & WILSON, INC.
GEOTECHNICAL AND ENVIRONMENTAL CONSULTANTS

FIG. 8

FIG. 8

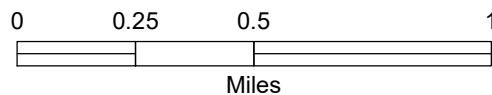


Sources: Esri, HERE, Garmin, Intermap, increment P Corp., GEBCO, USGS, FAO, NPS, NRCAN, GeoBase, IGN, Kadaster NL, Ordnance Survey, Esri Japan, METI, Esri China (Hong Kong), swisstopo, © OpenStreetMap contributors, and the GIS User Community

LEGEND

Site PGV (cm/sec)	20 - 22
10 - 12	22 - 24
12 - 14	24 - 26
14 - 16	26 - 28
16 - 18	28 - 30
18 - 20	30 - 32

★ City Properties



NOTES

1. PGV map for the magnitude 9.0 Cascadia Earthquake Scenario calculated from data provided in DOGAMI publications O-13-06 and OGDC-6, and methodology in Boore and Atkinson, 2008. See text for details.

City of Newberg Seismic Resiliency
Yamhill County, Oregon

PEAK GROUND VELOCITY, PGV

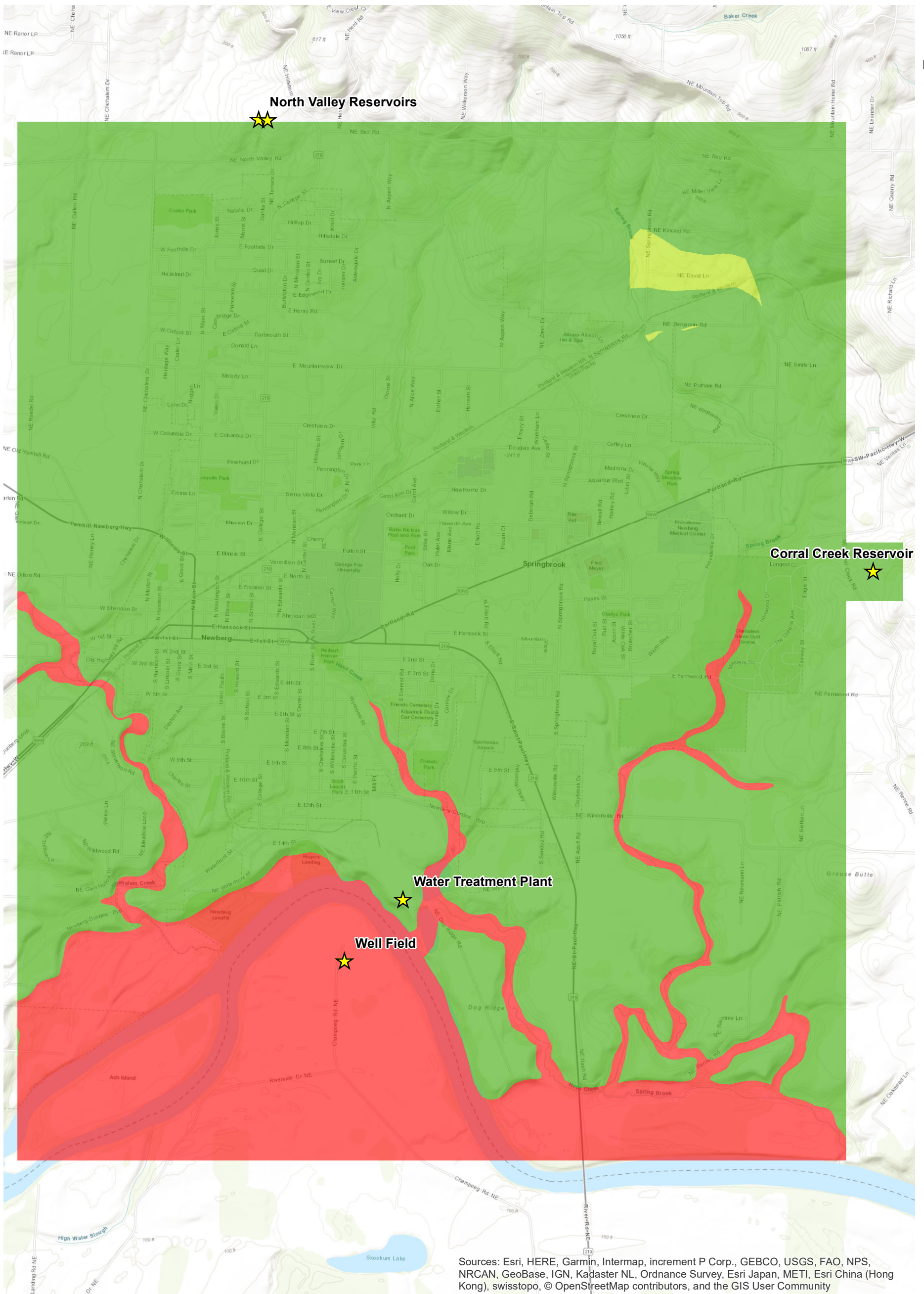
July 2020

101895

SHANNON & WILSON, INC.
GEOTECHNICAL AND ENVIRONMENTAL CONSULTANTS

FIG. 9

FIG. 9



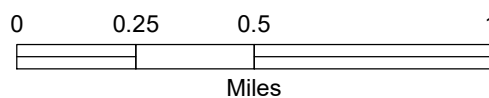
Sources: Esri, HERE, Garmin, Intermap, increment P Corp., GEBCO, USGS, FAO, NPS, NRCAN, GeoBase, IGN, Kadaster NL, Ordnance Survey, Esri Japan, METI, Esri China (Hong Kong), swisstopo, © OpenStreetMap contributors, and the GIS User Community

LEGEND

Liquefaction Probability (%)
(Proportion of Area Expected to Liquefy)

- 0 - 1
- 1 - 5
- 5 - 10
- 10 - 15

City Properties



NOTES

1. Probability of liquefaction for magnitude 9.0 Cascadia Earthquake Scenario calculated from data provided with DOGAMI publications O-12-02 and OGDC-6. See text for details.

City of Newberg Seismic Resiliency
Yamhill County, Oregon

PROBABILITY OF LIQUEFACTION

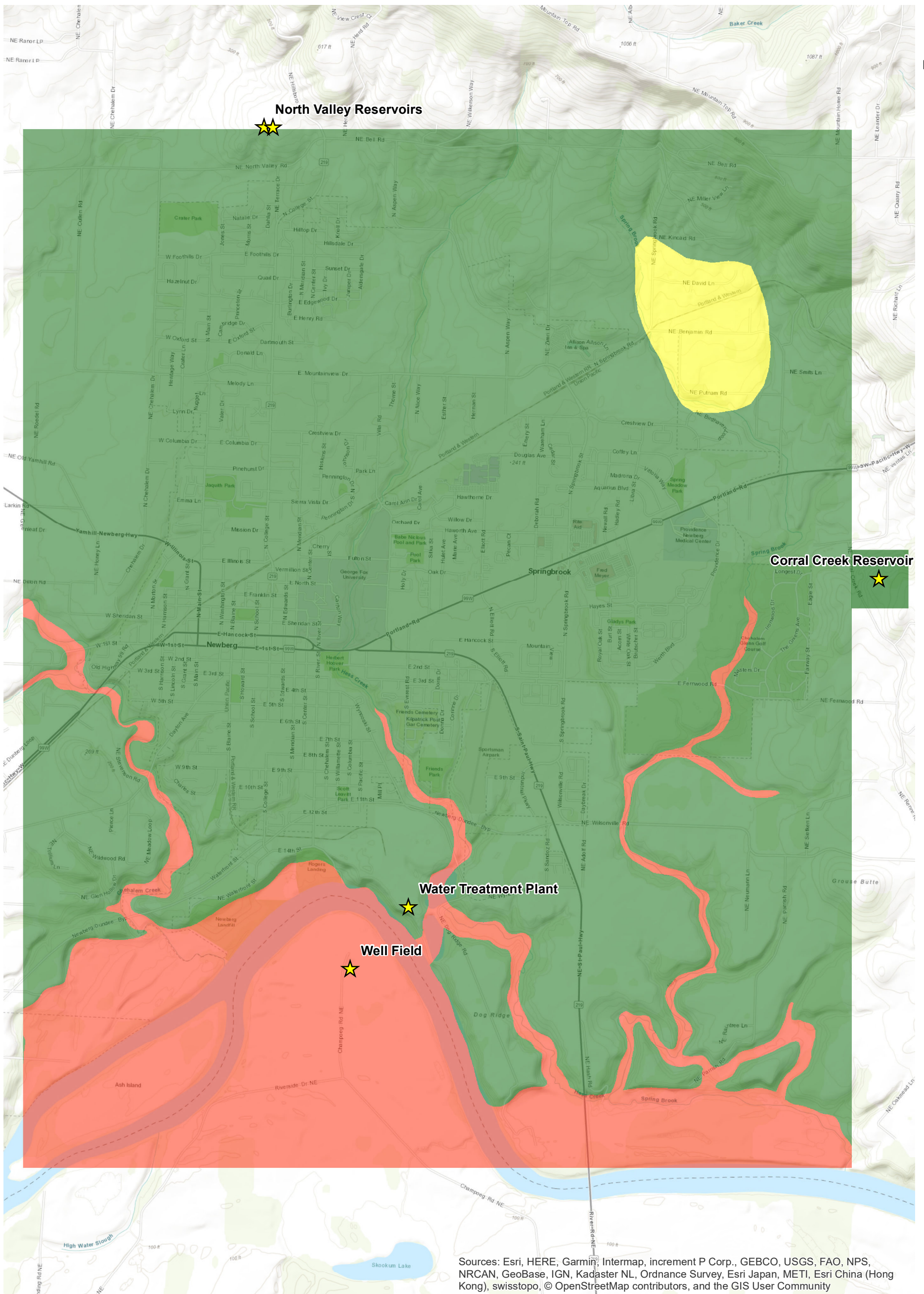
July 2020

101895

SHANNON & WILSON, INC.
GEOTECHNICAL AND ENVIRONMENTAL CONSULTANTS

FIG. 10

FIG. 10



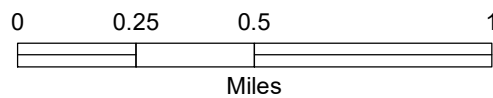
Sources: Esri, HERE, Garmin, Intermap, increment P Corp., GEBCO, USGS, FAO, NPS, NRCAN, GeoBase, IGN, Kadaster NL, Ordnance Survey, Esri Japan, METI, Esri China (Hong Kong), swisstopo, © OpenStreetMap contributors, and the GIS User Community

LEGEND

★ City Properties

Liquefaction-Induced Lateral Spreading PGD (in)

- 0 - 0.1
- 0.1 - 2
- 2 - 6
- 6 - 12
- 12 - 24



NOTES

1. Liquefaction-induced lateral spreading PGD for the magnitude 9.0 Cascadia Earthquake Scenario calculated from data provided with DOGAMI publications O-12-02, OGDC-6 and FEMA publication Hazus-MH 2.0 Technical Manual. See text for details.

City of Newberg Seismic Resiliency
Yamhill County, Oregon

LIQUEFACTION-INDUCED LATERAL SPREADING PERMANENT GROUND DEFORMATION, PGD

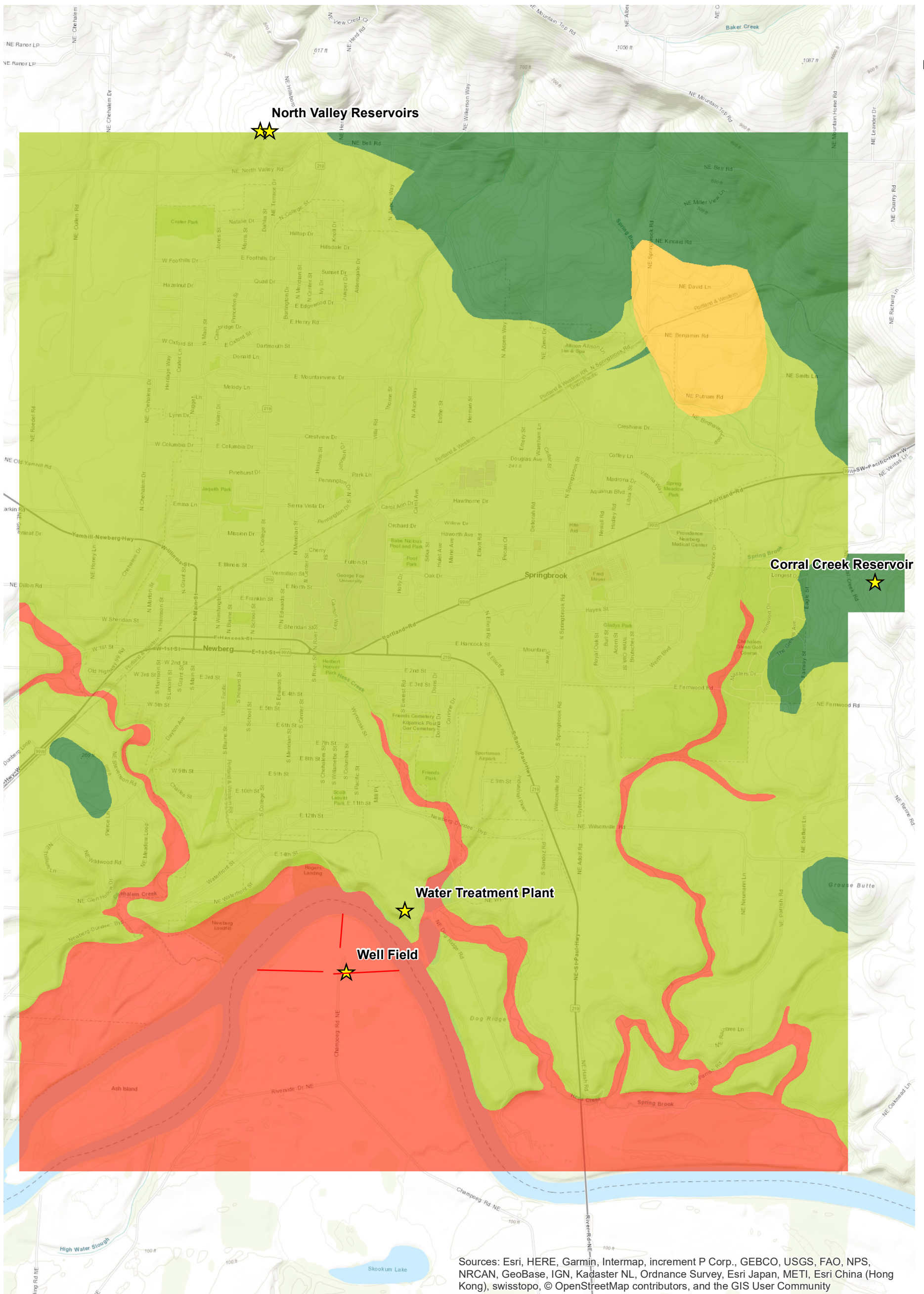
July 2020

101895

SHANNON & WILSON, INC.
GEOTECHNICAL AND ENVIRONMENTAL CONSULTANTS

FIG. 11

FIG. 11



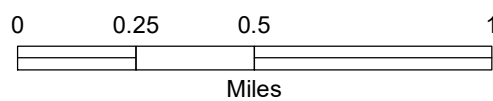
Sources: Esri, HERE, Garmin, Intermap, increment P Corp., GEBCO, USGS, FAO, NPS, NRCAN, GeoBase, IGN, Kadaster NL, Ordnance Survey, Esri Japan, METI, Esri China (Hong Kong), swisstopo, © OpenStreetMap contributors, and the GIS User Community

LEGEND

★ City Properties

Liquefaction-Induced Settlement PGD (in)

- 0
- 0.5 - 1.5
- 1.5 - 2
- 2 - 6



NOTES

1. Liquefaction-induced settlement PGD for the magnitude 9.0 Cascadia Earthquake Scenario calculated from data provided with DOGAMI publications O-12-02, OGDC-6 and FEMA publication Hazus-MH 2.0 Technical Manual. See text for details.

City of Newberg Seismic Resiliency
Yamhill County, Oregon

**LIQUEFACTION-INDUCED
SETTLEMENT PERMANENT
GROUND DEFORMATION, PGD**

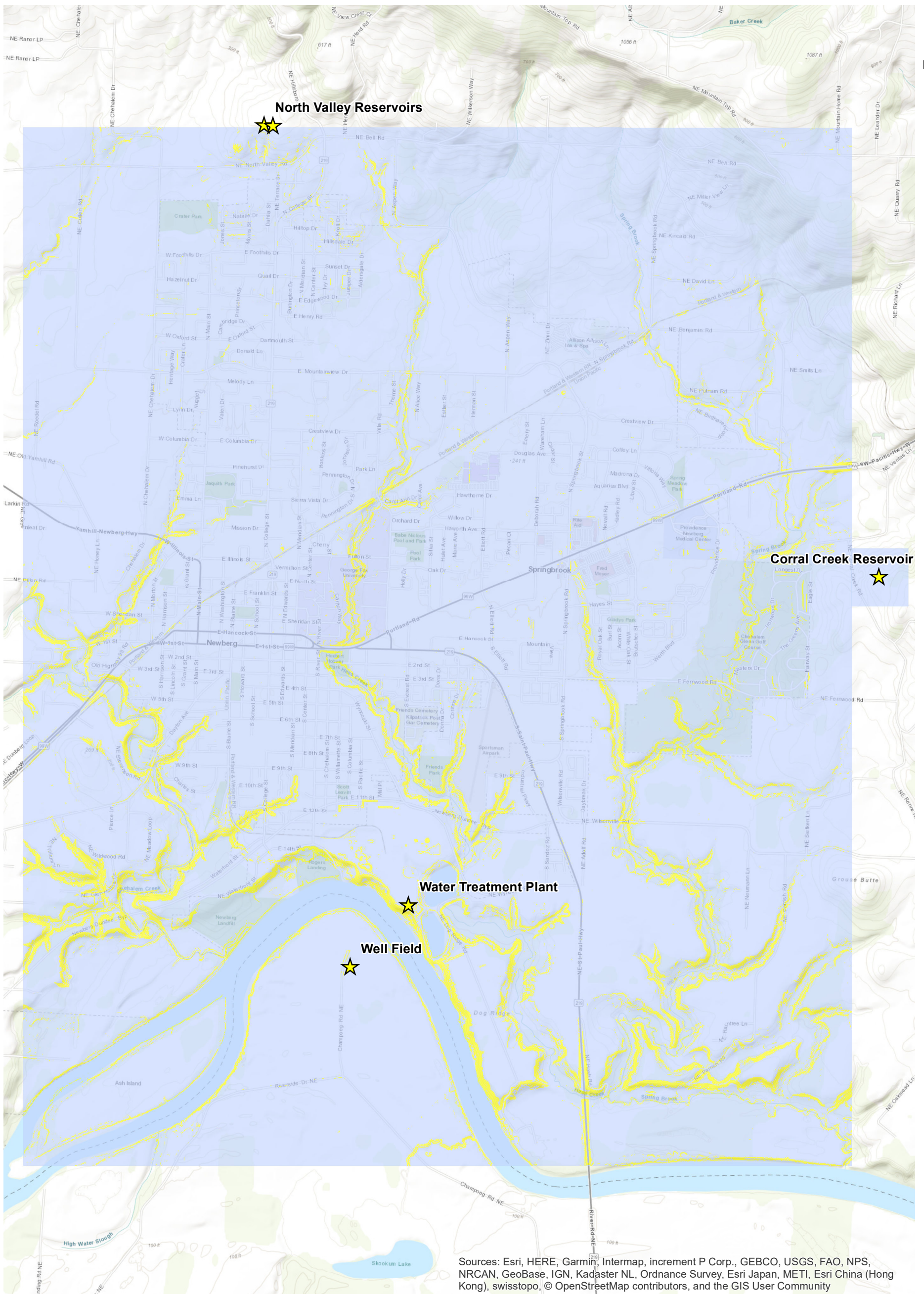
July 2020

101895

SHANNON & WILSON, INC.
GEOTECHNICAL AND ENVIRONMENTAL CONSULTANTS

FIG. 12

FIG. 12



Sources: Esri, HERE, Garmin, Intermap, increment P Corp., GEBCO, USGS, FAO, NPS, NRCAN, GeoBase, IGN, Kadaster NL, Ordnance Survey, Esri Japan, METI, Esri China (Hong Kong), swisstopo, © OpenStreetMap contributors, and the GIS User Community

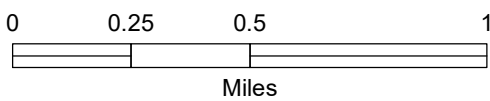
LEGEND

★ City Properties

Earthquake-Induced Landslide Probability in Dry Conditions (%)

(Proportion of Area Expected to Fail)

0
25



NOTES

1. Earthquake-induced landslide probability for the magnitude 9.0 Cascadia Earthquake Scenario calculated from data provided with DOGAMI publications O-12-02, OGDC-6, SLIDO-3.4 and LIDAR. See text for details.

City of Newberg Seismic Resiliency
Yamhill County, Oregon

PROBABILITY OF EARTHQUAKE-INDUCED LANDSLIDES (DRY)

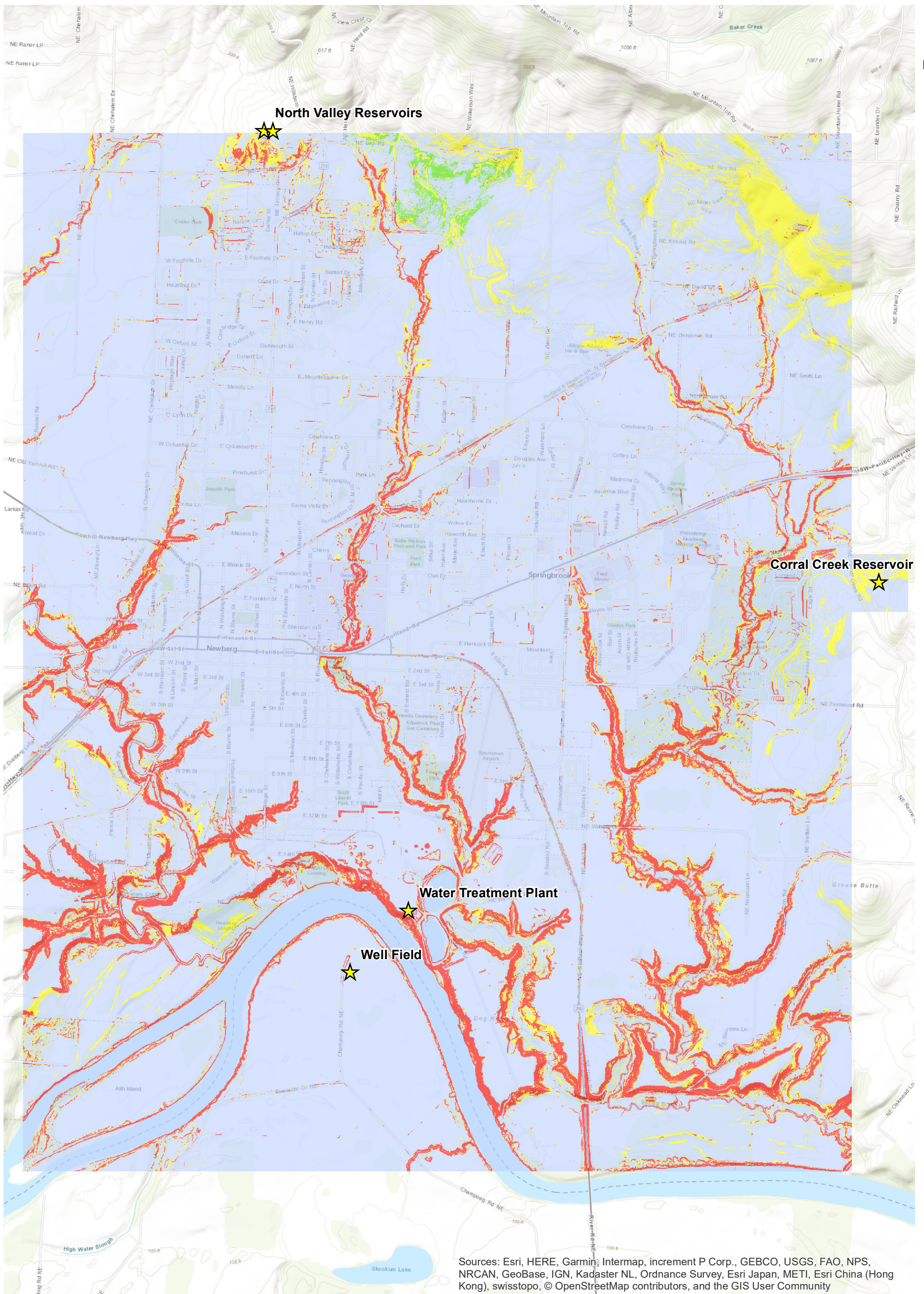
July 2020

101895

SHANNON & WILSON, INC.
GEOTECHNICAL AND ENVIRONMENTAL CONSULTANTS

FIG. 13

FIG. 13



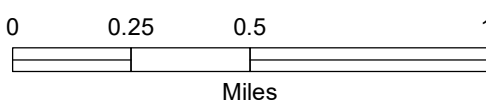
Sources: Esri, HERE, Garmin, Intermap, increment P Corp., GEBCO, USGS, FAO, NPS, NRCAN, GeoBase, IGN, Kadaster NL, Ordnance Survey, Esri Japan, METI, Esri China (Hong Kong), swisstopo, © OpenStreetMap contributors, and the GIS User Community

LEGEND

★ City Properties

Earthquake-Induced Landslide Probability in Wet Conditions (5)
(Proportion of Area Expected to Fail)

- 0
- 20
- 25
- 30



NOTES

1. Earthquake-induced landslide probability for the magnitude 9.0 Cascadia Earthquake Scenario calculated from data provided with DOGAMI publications O-12-02, OGDC-6, SLIDO-3.4 and LIDAR. See text for details.

FIG. 14

City of Newberg Seismic Resiliency
 Yamhill County, Oregon

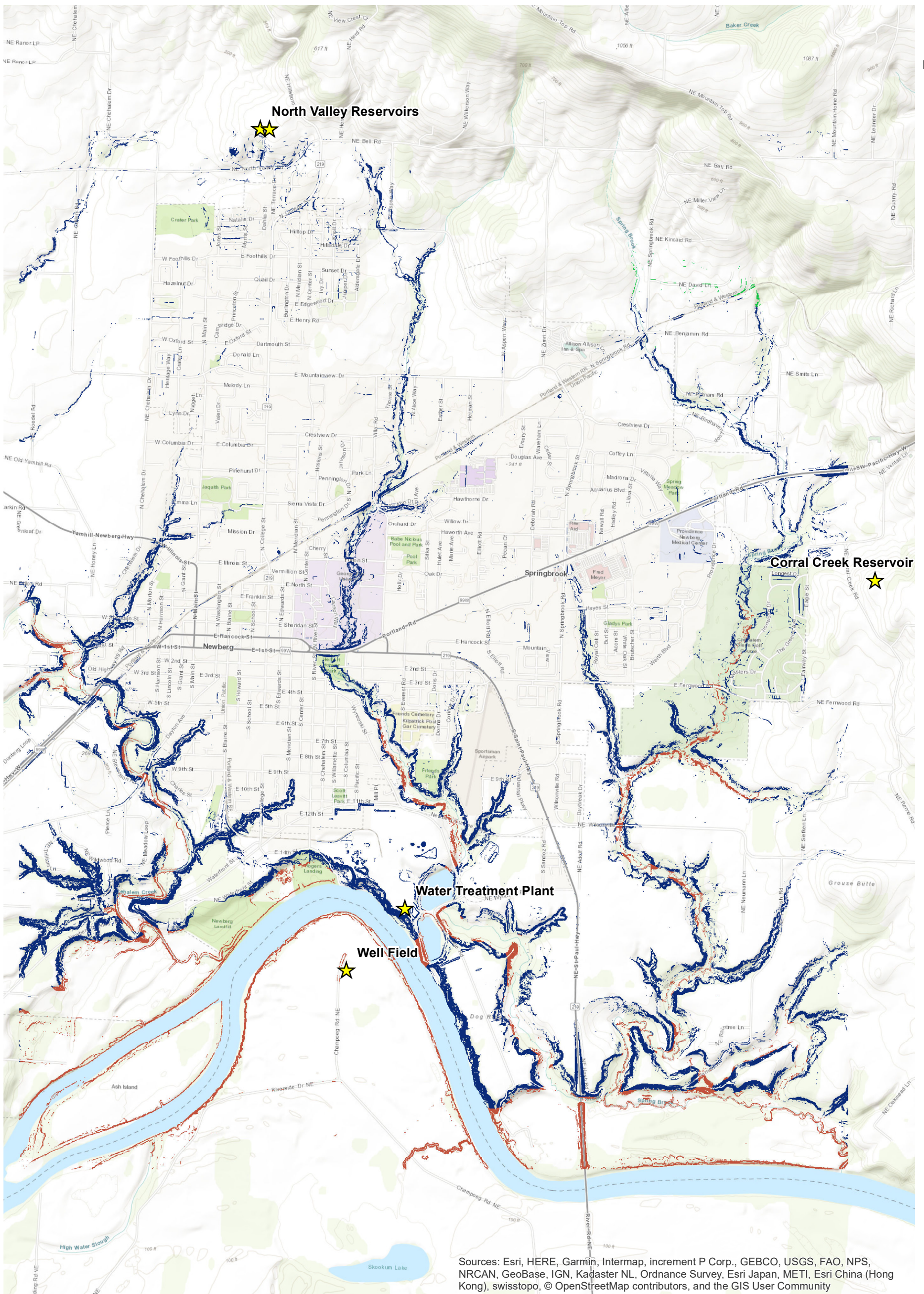
PROBABILITY OF EARTHQUAKE-INDUCED LANDSLIDES (WET)

July 2020

101895

SHANNON & WILSON, INC.
 GEOTECHNICAL AND ENVIRONMENTAL CONSULTANTS

FIG. 14



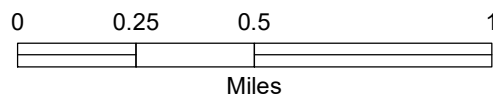
Sources: Esri, HERE, Garmin, Intermap, increment P Corp., GEBCO, USGS, FAO, NPS, NRCAN, GeoBase, IGN, Kadaster NL, Ordnance Survey, Esri Japan, METI, Esri China (Hong Kong), swisstopo, © OpenStreetMap contributors, and the GIS User Community

LEGEND

Earthquake-Induced Landslide PGD (ft)

- Negligible
- < 2
- 2 - 3
- 2 - 4
- 4+

★ City Properties



NOTES

1. Earthquake-induced landslide PGD for the magnitude 9.0 Cascadia Earthquake Scenario calculated from data provided with DOGAMI publications O-12-02, OGDC-6, SLIDO-3.4, and LiDAR. See text for details.

City of Newberg Seismic Resiliency
Yamhill County, Oregon

**EARTHQUAKE-INDUCED
LANDSLIDE PERMANENT GROUND
DEFORMATION, PGD (DRY)**

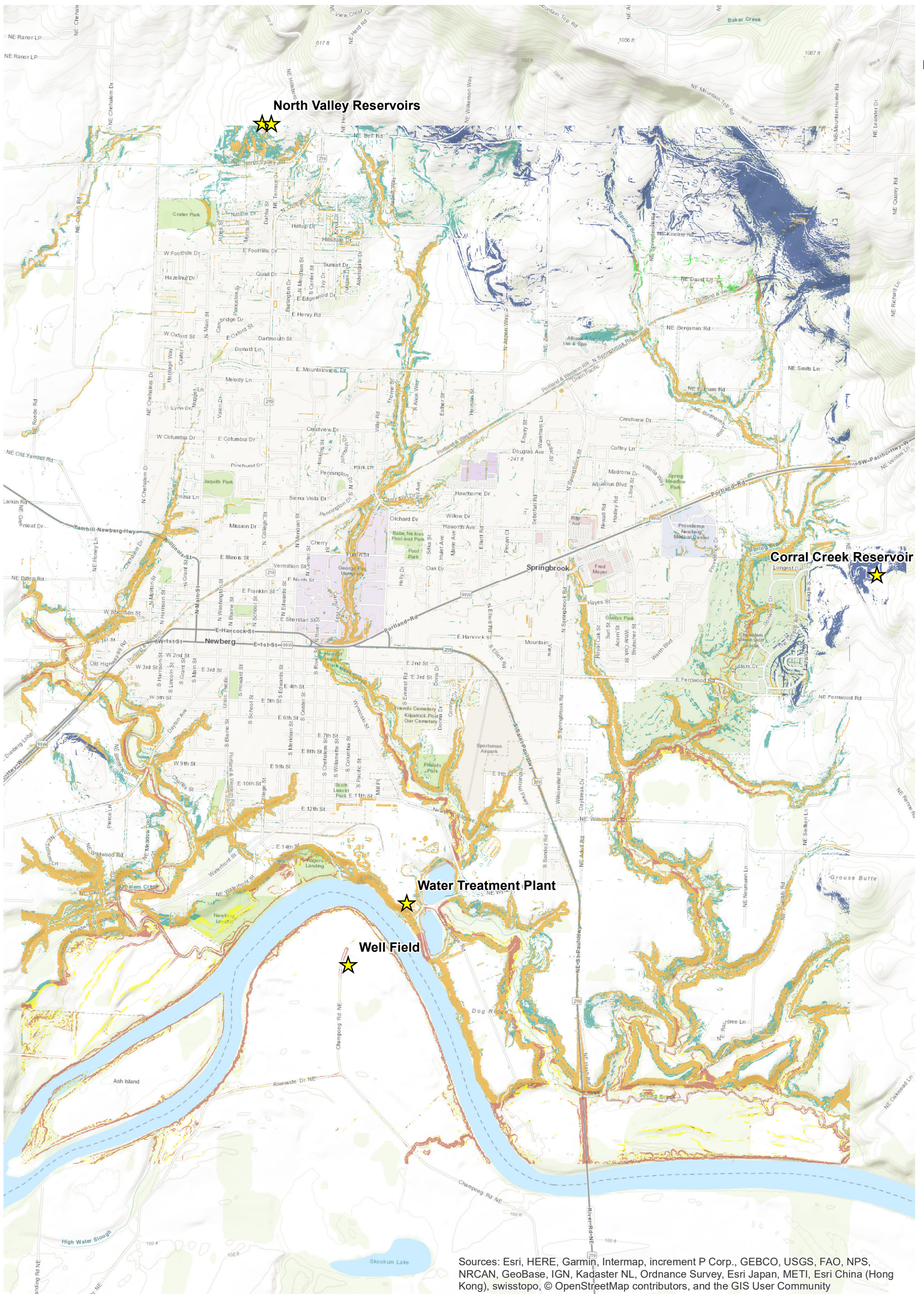
July 2020

101895

SHANNON & WILSON, INC.
GEOTECHNICAL AND ENVIRONMENTAL CONSULTANTS

FIG. 15

FIG. 15



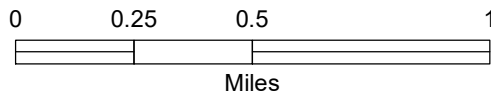
Sources: Esri, HERE, Garmin, Intermap, increment P Corp., GEBCO, USGS, FAO, NPS, NRCAN, GeoBase, IGN, Kadaster NL, Ordnance Survey, Esri Japan, METI, Esri China (Hong Kong), swisstopo, © OpenStreetMap contributors, and the GIS User Community

LEGEND

**Earthquake-Induced Landslide PGD (ft)
(Wet Conditions)**

- Negligible
- < 1
- 1 - 2
- 2 - 5
- 5 - 10
- 10 - 20
- 20+

★ City Properties



NOTES

1. Earthquake-induced landslide PGD for the magnitude 9.0 Cascadia Earthquake Scenario calculated from data provided with DOGAMI publications O-12-02, OGDC-6, SLIDO-3.4, and LiDAR. See text for details.

City of Newberg Seismic Resiliency
Yamhill County, Oregon

**EARTHQUAKE-INDUCED
LANDSLIDE PERMANENT GROUND
DEFORMATION, PGD (WET)**

July 2020

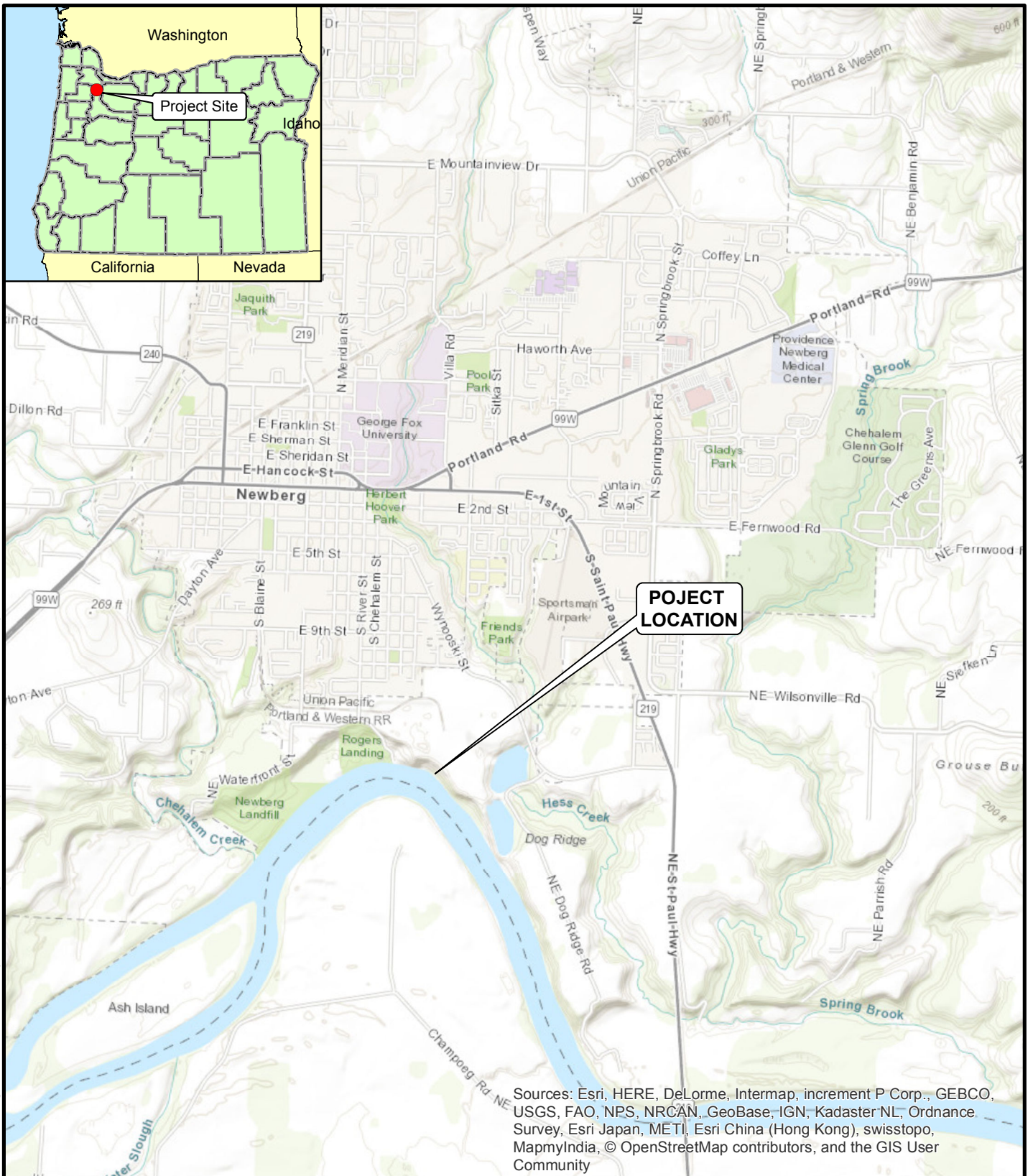
101895

SHANNON & WILSON, INC.
GEOTECHNICAL AND ENVIRONMENTAL CONSULTANTS

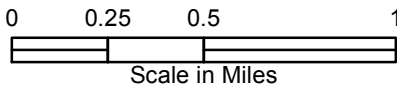
FIG. 16

FIG. 16

Path: T:\Projects\PD\101000s\101895_Newberg Seismic Resiliency\Avmxd\Figure 1 - Vicinity Map.mxd 10/11/2018 kjw



Sources: Esri, HERE, DeLorme, Intermap, increment P Corp., GEBCO, USGS, FAO, NPS, NRCAN, GeoBase, IGN, Kadaster NL, Ordnance Survey, Esri Japan, METI, Esri China (Hong Kong), swisstopo, MapmyIndia, © OpenStreetMap contributors, and the GIS User Community



City of Newberg Water System Resiliency
Yamhill County, Oregon

**WATER TREATMENT PLANT
VICINITY MAP**

July 2020

101895

SHANNON & WILSON, INC.
Geotechnical and Environmental Consultants

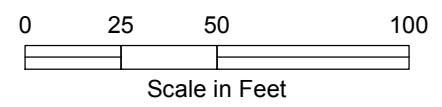
FIG. 17

Filename: T:\Projects\101000s\101895_Newberg Seismic Resiliency\A\mxd\Figure 18 - Site Plan.mxd Date: 5/7/2019 Login: kjw



Source: Esri, DigitalGlobe, GeoEye, Earthstar Geographics, CNES/Airbus DS, USDA, USGS, AeroGRID, IGN, and the GIS User Community

- LEGEND**
- B-1 Designation and Approximate Location of Boring
 - Approximate Location of Slope Stability Cross Section



Note: Not shown are the historical explorations for the slope repair performed by Squier Associates in 1999 and the slope evaluation performed by Northwest Geotech, Inc. in 2016

City of Newberg Water System Resiliency Yamhill County, Oregon	
WATER TREATMENT PLANT SLOPE SITE AND EXPLORATION PLAN	
July 2020	101895
SHANNON & WILSON, INC. <small>GEOTECHNICAL AND ENVIRONMENTAL CONSULTANTS</small>	FIG. 18

Appendix A

Field Explorations

CONTENTS

A.1 General..... A-1

 A.1.1 Cone Penetration Testing..... A-1

 A.1.2 CPT Logs A-1

 A.1.3 Geoprobe Explorations..... A-2

 A.1.4 Exploration Backfill..... A-2

Figures

- Figure A-1: Interpreted CPT Sounding CPT-1
- Figure A-2: Interpreted CPT Sounding CPT-2
- Figure A-3: Log of Geoprobe Exploration P-1
- Figure A-4: Log of Geoprobe Exploration P-2

Attachments

- Oregon Geotechnical Explorations Raw CPT Files

A.1 GENERAL

The field exploration program included two Cone Penetration Tests (CPTs) and two geoprobe explorations. The exploration locations were not surveyed but were referenced to nearby existing structures and should be considered approximate. Approximate CPT locations are shown on the Site and Exploration Plan, Figure 18. The CPTs and geoprobes were completed on May 20, 2019, by Oregon Geotechnical Explorations, Inc. (OGE), of Keizer, Oregon. This appendix describes general exploration methods and presents logs of the materials encountered.

A.1.1 Cone Penetration Testing

OGE pushed CPT-1 and CPT-2 using a track-mounted CPT rig, which uses helical anchors, drilled into the ground, to help the rig to push down with a force greater than its weight. CPT-1 and CPT-2 were advanced to depths of 83 and 68 feet, respectively.

During a CPT, a specialized cone assembly at the end of a steel probe is hydraulically pushed down through the subsurface. The cone assembly contains load cells and associated strain gauges which monitor the deformation of the load cells. One set of load cells deforms with increasing resistance to cone tip penetration. Another set of load cells deforms with increasing frictional resistance encountered on a sleeve on the outside of the assembly. The cone assembly also contains a piezometer which measures pore pressure. Data from the strain gauges and from the piezometer are transmitted from the cone assembly back through extension rods to a CPT recording device via a cable. Analysis software using industry standard calculations then converts the raw data signals from the instruments into cone resistance, sleeve friction, and pore pressure.

Pore pressure is useful in estimating soil behavior type because penetration has varying effects on pore pressure, depending on the type of material being penetrated. Dissipation of pore pressure can also be measured if the cone advance is temporarily halted. Pore pressure dissipation tests were performed at one depth in CPT-1 and can be used to estimate the static groundwater level and to estimate the soil hydraulic conductivity at the test location. Twenty-five shear wave velocity tests were performed in CPT-1.

A.1.2 CPT Logs

All raw CPT data was reduced by OGE into values of cone resistance, sleeve friction, and pore pressure. Shannon & Wilson prepared graphic plots of the reduced data, along with several interpreted engineering parameters. The plots are presented in Figures A1 and A2, and include cone resistance (q_t) in tons per square foot (tsf), sleeve friction (f_s) in tsf, friction

ratio (f_s/q_t) expressed as a percentage, pore pressure in tsf, estimated soil behavior type (SBT), undrained shear strength in pounds per square foot (psf), and estimated SPT N-value (N_{60}) in blows per foot (bpf). Plots of the pore pressure dissipation tests, prepared by OGE, are enclosed at the end of this attachment.

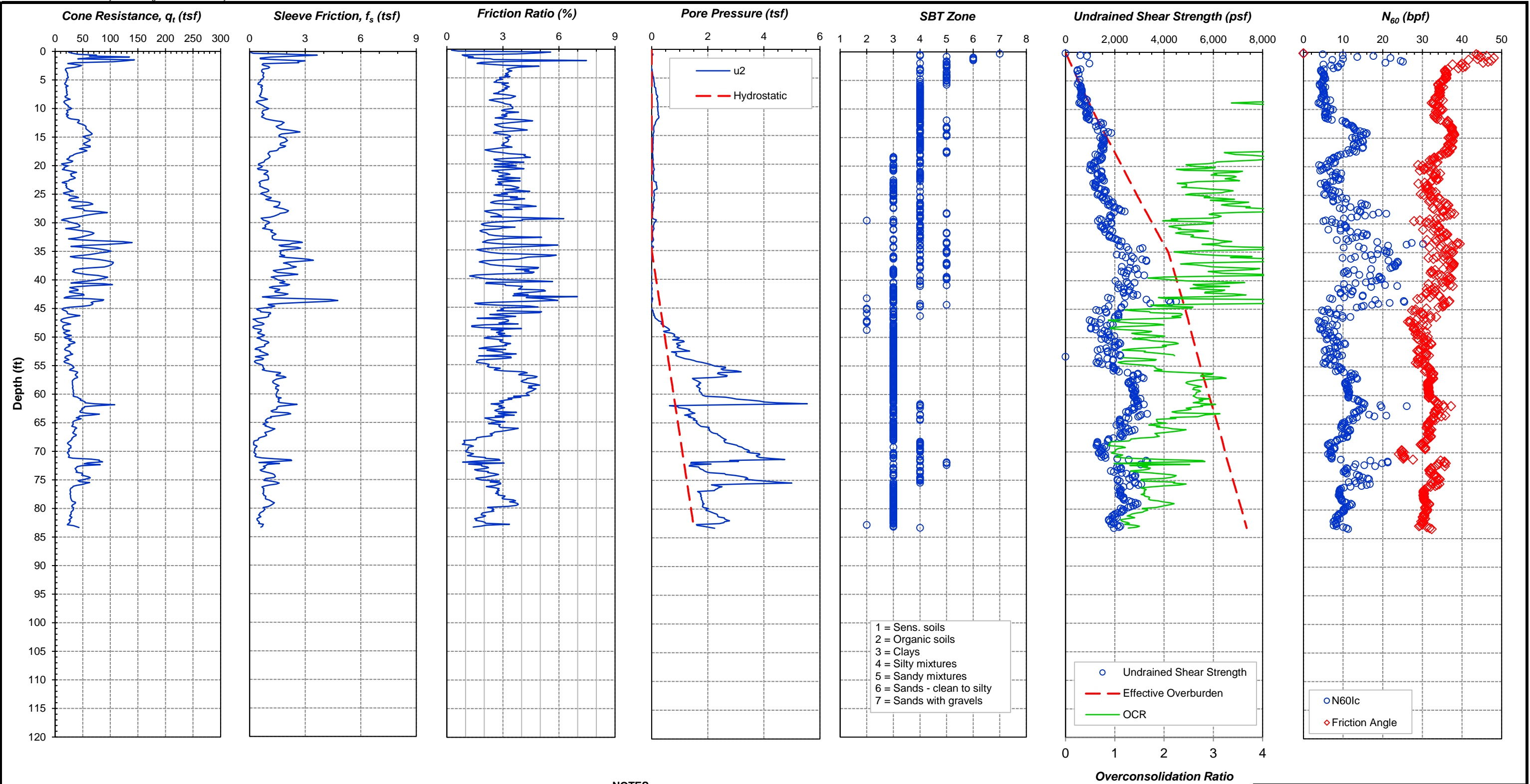
A.1.3 Geoprobe Explorations

Geoprobe explorations P-1 and P-2 were advanced to depths of 68 and 30 feet, respectively. Samples were not able to be recovered from approximately 10 to 40 feet during exploration P-1. Therefore, an additional geoprobe P-2 was performed to obtain samples from the zone that was not recovered from P-1.

The probes were advanced using a track-mounted Geoprobe™ drill rig capable of continuous push probe sampling. Soil sampling was performed using a track-mounted, direct push probe rig equipped with 2.5-inch-outside-diameter casing. Samples were collected by advancing casings lined with 4-foot plastic sleeves using percussive force to remove soils in their path.

A.1.4 Exploration Backfill

All holes were backfilled in accordance with Oregon Department of Ecology regulations. No wells or other instruments were installed in the holes. The holes were backfilled from the bottom up to the existing ground surface using bentonite chips.



NOTES:

1. SBT zone computed using procedure by Jefferies & Been (2006).
2. Undrained shear strength computed using the following equation:

$$s_u = \sigma'_v (s_u / \sigma'_v)_{NC} OCR^m$$
 where $(s_u / \sigma'_v)_{NC} = 0.22$ and $m = 0.8$.
3. Preconsolidation pressure computed using procedure by Mayne and others (2009).
4. N_{60} computed using procedure by Lunne and others (1997).
5. Ground surface elevation apprx. = 170 ft.

City of Newberg Seismic Resiliency
Yamhill County, Oregon

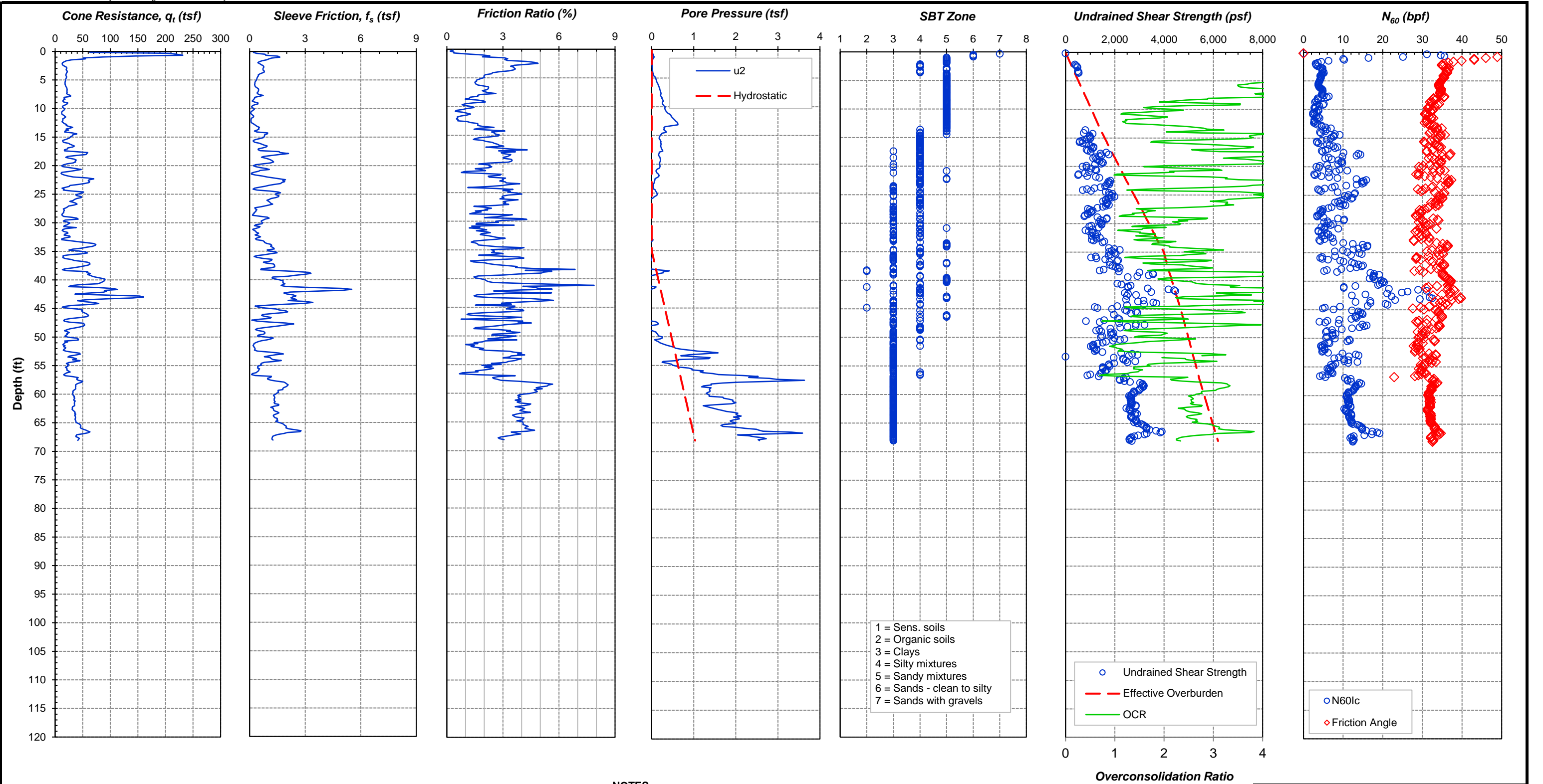
**INTERPRETED CPT SOUNDING
CPT-1**

July 2020

101895

SHANNON & WILSON, INC.
Geotechnical and Environmental Consultants

FIG. A1



NOTES:

1. SBT zone computed using procedure by Jefferies & Been (2006).
2. Undrained shear strength computed using the following equation:

$$s_u = \sigma'_v (s_u / \sigma'_v)_{NC} OCR^m$$
 where $(s_u / \sigma'_v)_{NC} = 0.22$ and $m = 0.8$.
3. Preconsolidation pressure computed using procedure by Mayne and others (2009).
4. N_{60} computed using procedure by Lunne and others (1997).
5. Ground surface elevation apprx. = 170 ft.

City of Newberg Seismic Resiliency
Yamhill County, Oregon

**INTERPRETED CPT SOUNDING
CPT-2**

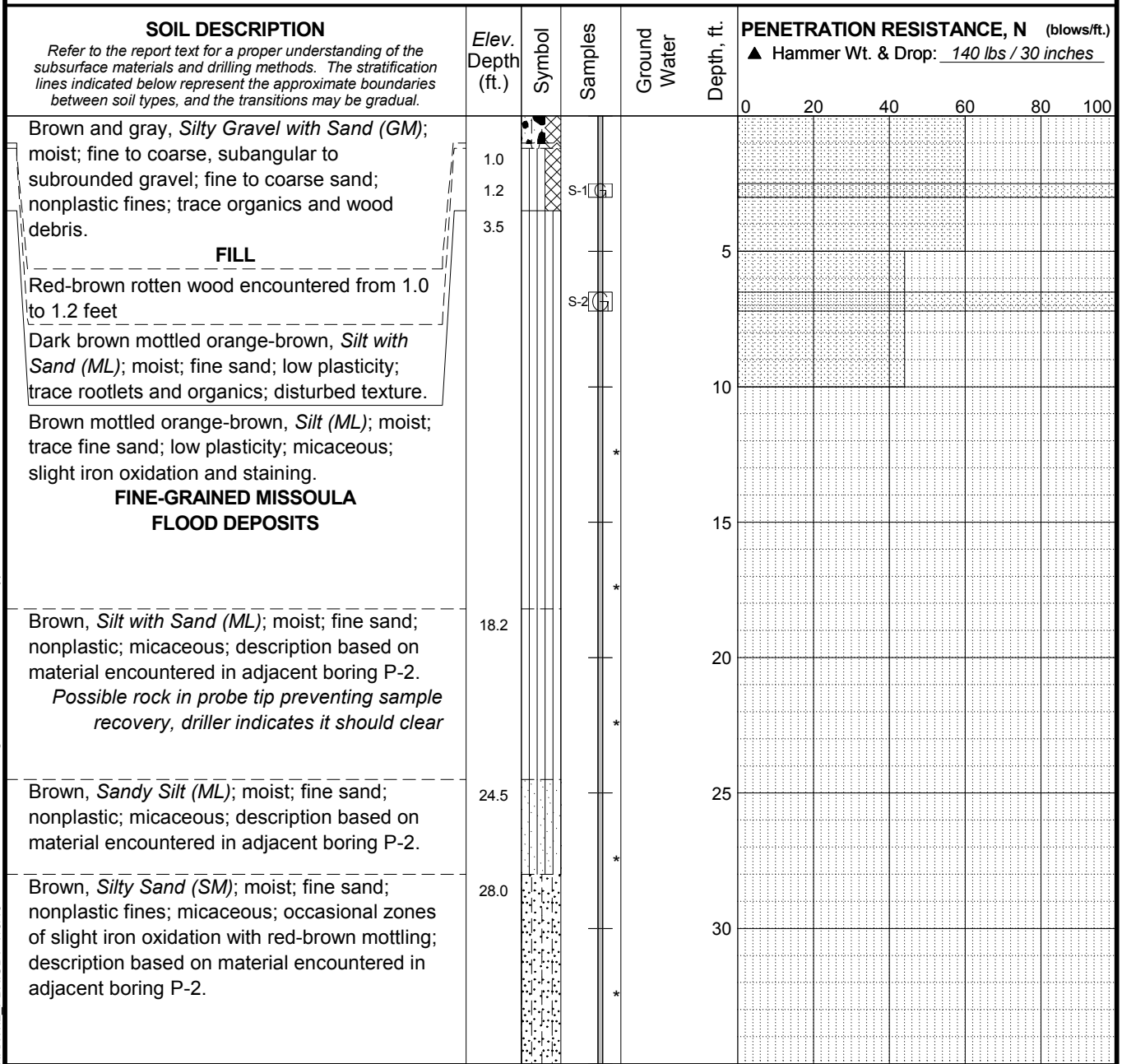
July 2020

101895

SHANNON & WILSON, INC.
Geotechnical and Environmental Consultants

FIG. A2

Total Depth: 68 ft. Northing: ~ Drilling Method: Direct Push Hole Diam.: 2.5 in.
 Top Elevation: ~ Easting: ~ Drilling Company: Oregon Geotechnical Rod Type: N/A
 Vert. Datum: ~ Station: ~ Drill Rig Equipment: Geoprobe 6622 Track Rig Hammer Type: N/A
 Horiz. Datum: ~ Offset: ~ Other Comments: ~



Typ: CKS
 Rev:
 Log: CKS
 PDX.GDT: 7/9/19
 SHANNWIL
 SW2013LIBRARYPDX.GLB
 101895 GINT.GPJ

CONTINUED NEXT SHEET

- LEGEND**
- * Sample Not Recovered
 - 1" Plastic Sheath
 - Grab Sample

Recovery (%)

● % Water Content
 Plastic Limit ——— Liquid Limit

NOTES

- Refer to KEY for explanation of symbols, codes, abbreviations, and definitions.
- Groundwater level, if indicated above, is for the date specified and may vary.
- Group symbol is based on visual-manual identification and selected lab testing.
- The hole location and elevation should be considered approximate.

City of Newberg Seismic Resiliency Plan
 Newberg, Oregon

LOG OF BORING P-1

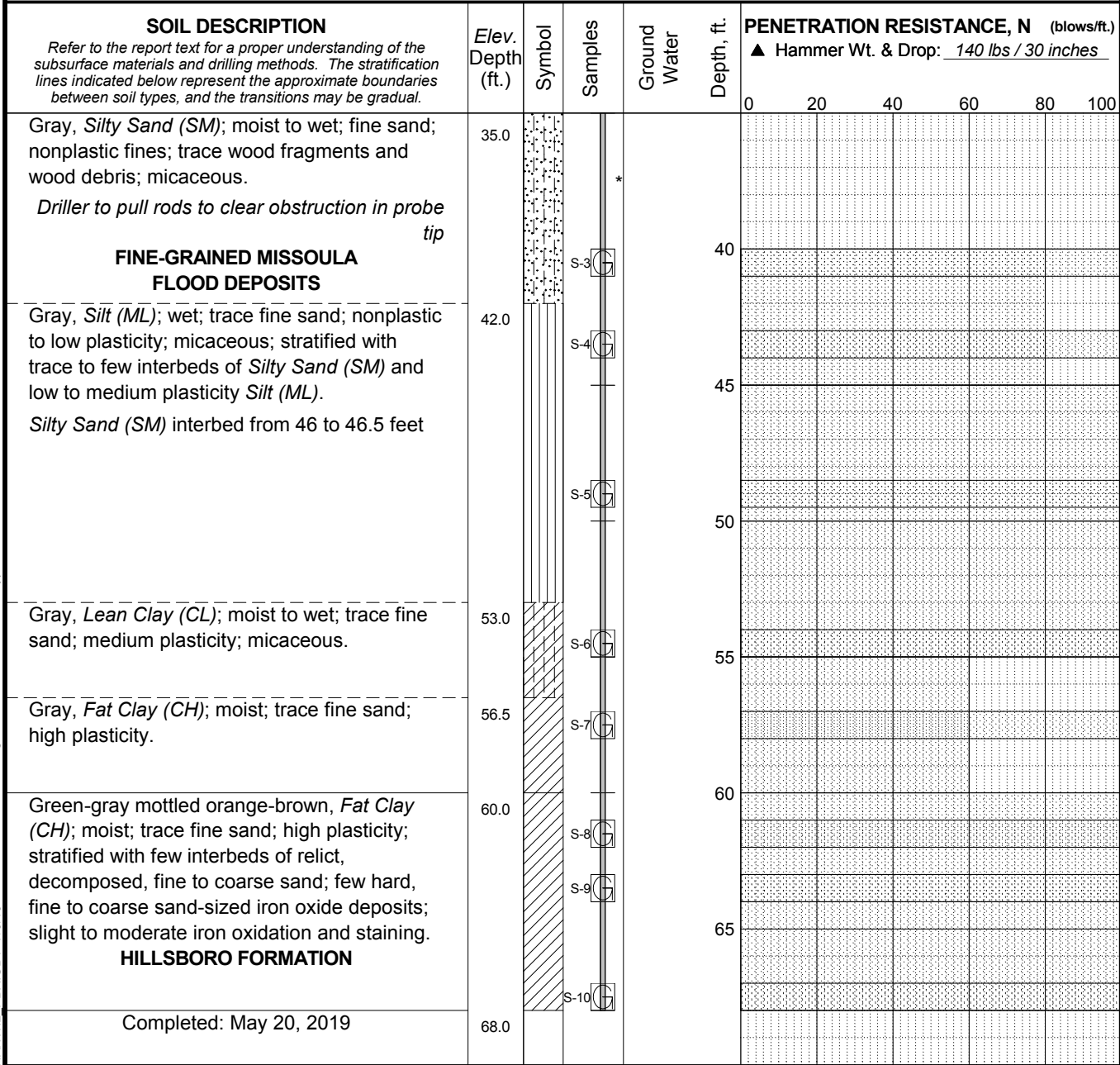
June 2020

101895

SHANNON & WILSON, INC.
 Geotechnical and Environmental Consultants

FIG. A3
 Sheet 1 of 2

Total Depth: 68 ft. Northing: ~ Drilling Method: Direct Push Hole Diam.: 2.5 in.
 Top Elevation: ~ Easting: ~ Drilling Company: Oregon Geotechnical Rod Type: N/A
 Vert. Datum: ~ Station: ~ Drill Rig Equipment: Geoprobe 6622 Track Rig Hammer Type: N/A
 Horiz. Datum: ~ Offset: ~ Other Comments: ~



Typ: CKS
 Rev:
 Log: CKS
 MASTER LOG - E 101895 GINT.GPJ - SW2013\LIBRARY\PD\X.GLB - SHANNIL_PDX.GDT 7/9/19

LEGEND
 * Sample Not Recovered
 [Symbol] 1" Plastic Sheath
 (G) Grab Sample

Recovery (%) [Symbol]
 ● % Water Content
 Plastic Limit [Symbol] Liquid Limit

- NOTES**
- Refer to KEY for explanation of symbols, codes, abbreviations, and definitions.
 - Groundwater level, if indicated above, is for the date specified and may vary.
 - Group symbol is based on visual-manual identification and selected lab testing.
 - The hole location and elevation should be considered approximate.

City of Newberg Seismic Resiliency Plan
Newberg, Oregon

LOG OF BORING P-1

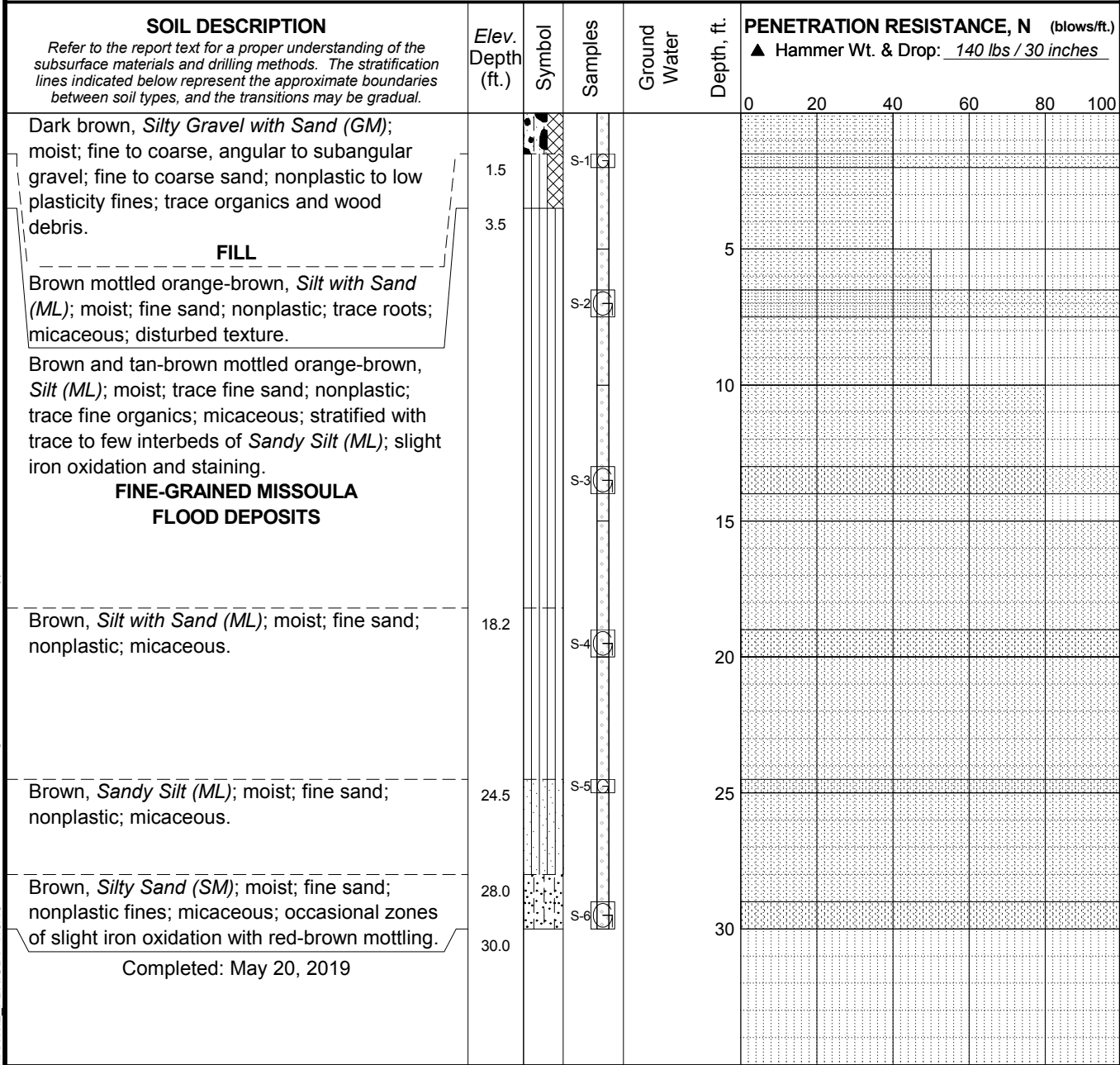
June 2020 101895

SHANNON & WILSON, INC.
Geotechnical and Environmental Consultants

FIG. A3
Sheet 2 of 2

Total Depth: 30 ft. Northing: ~ Drilling Method: Direct Push Hole Diam.: 2.5 in.
 Top Elevation: ~ Easting: ~ Drilling Company: Oregon Geotechnical Rod Type: N/A
 Vert. Datum: Station: ~ Drill Rig Equipment: Geoprobe 6622 Track Rig Hammer Type: N/A
 Horiz. Datum: Offset: ~ Other Comments: _____

Typ: CKS
 Rev:
 Log: CKS
 MASTER LOG-E 101895 GINT.GPJ SW2013\LIBRARY\PDX.GLB SHANNWIL_PDX.GDT 7/9/19



LEGEND

2" Plastic Sheath

Grab Sample

Recovery (%)

% Water Content

Plastic Limit Liquid Limit

- NOTES**
1. Refer to KEY for explanation of symbols, codes, abbreviations, and definitions.
 2. Groundwater level, if indicated above, is for the date specified and may vary.
 3. Group symbol is based on visual-manual identification and selected lab testing.
 4. The hole location and elevation should be considered approximate.

City of Newberg Seismic Resiliency Plan
Newberg, Oregon

LOG OF BORING P-2

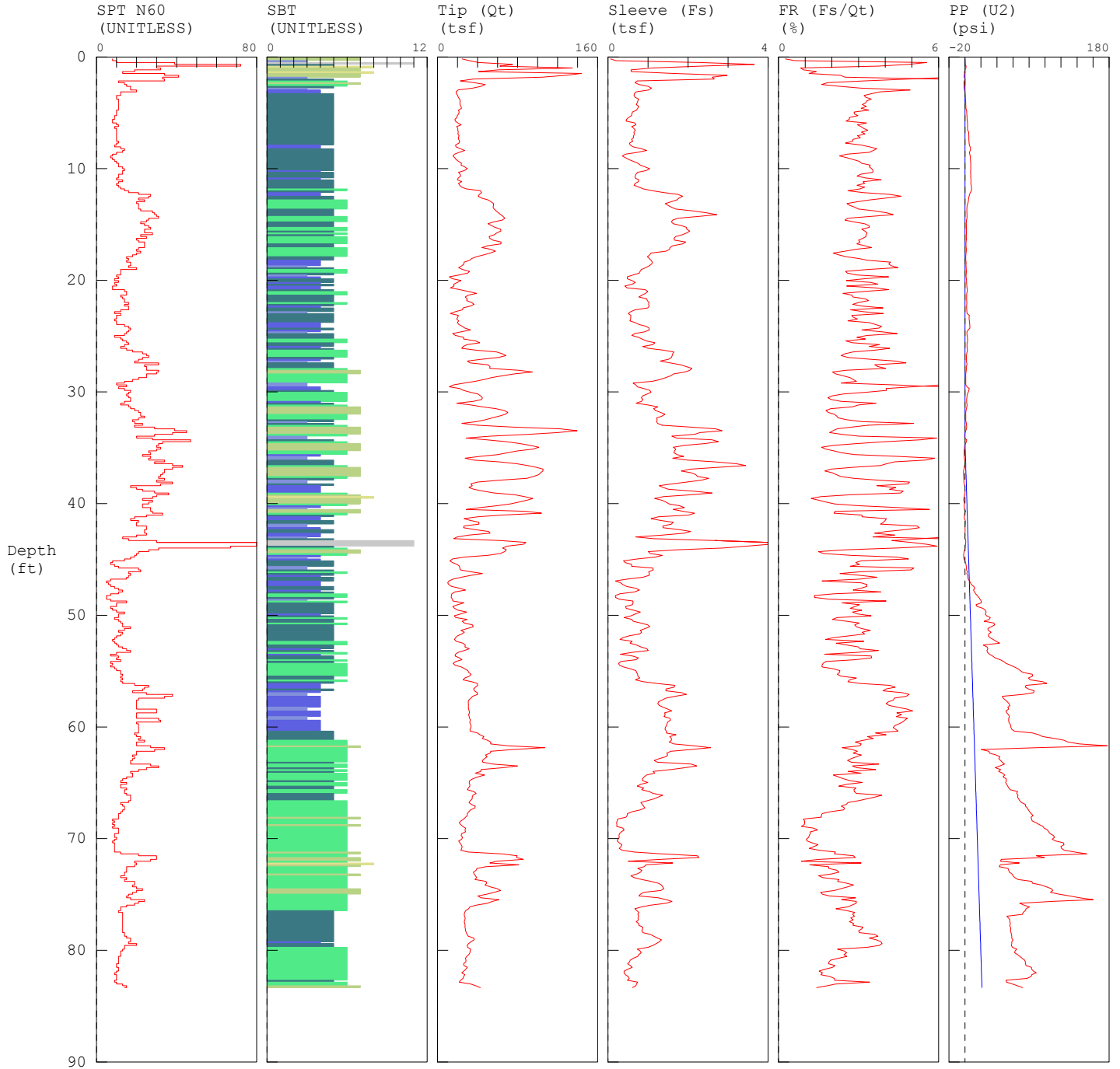
June 2020 101895

SHANNON & WILSON, INC.
Geotechnical and Environmental Consultants

FIG. A4

Shannon & Wilson / CPT-1 / 1400 Wynooski St Newberg

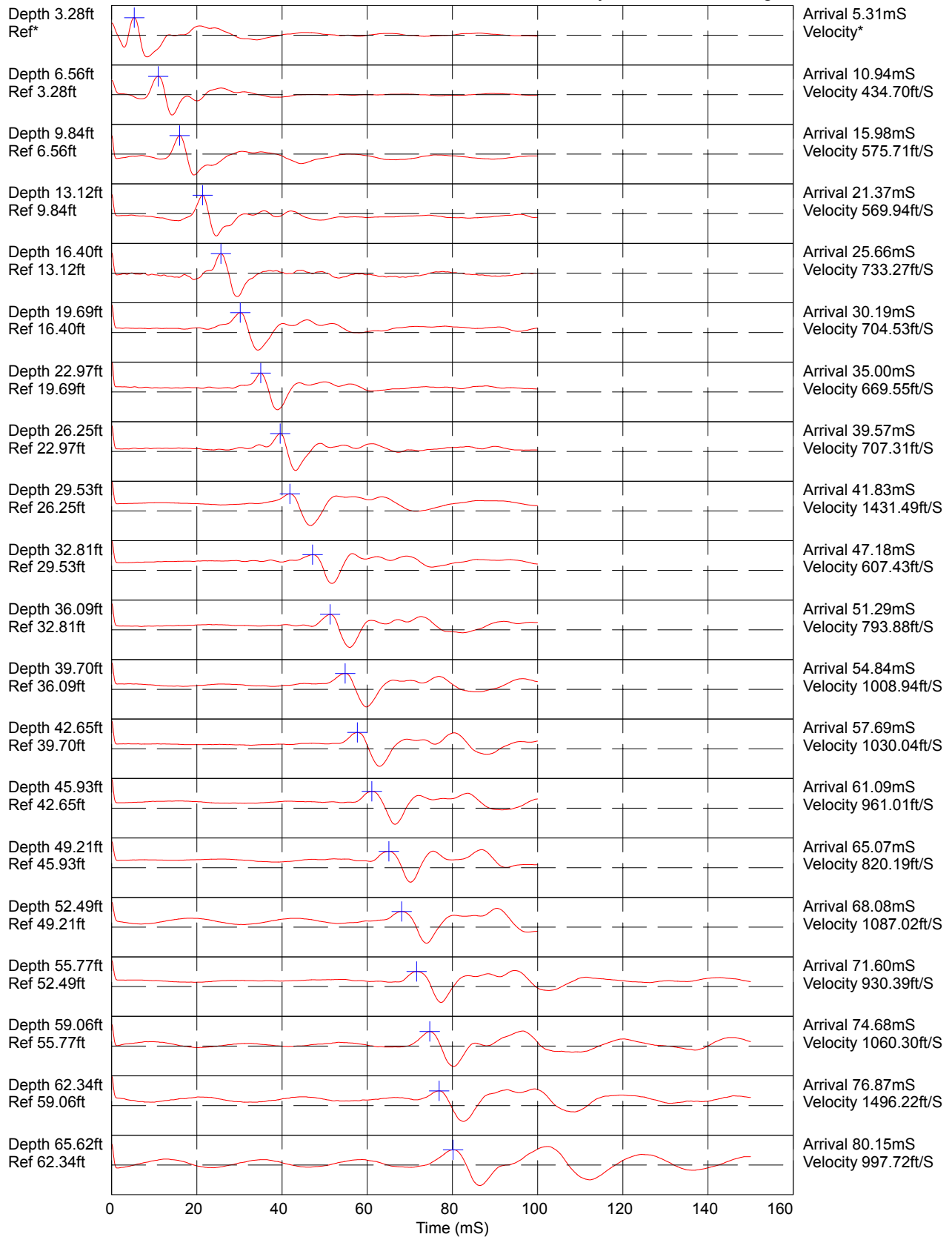
OPERATOR: OGE DMM
 CONE ID: DDG1415
 HOLE NUMBER: CPT-1
 TEST DATE: 5/20/2019 8:53:04 AM
 TOTAL DEPTH: 83.333 ft



■ 1	sensitive fine grained	■ 4	silty clay to clay	■ 7	silty sand to sandy silty
■ 2	organic material	■ 5	clayey silt to silty clay	■ 8	sand to silty sand
■ 3	clay	■ 6	sandy silt to clayey silt	■ 9	sand
				■ 10	gravelly sand to sand
				■ 11	very stiff fine grained (*)
				■ 12	sand to clayey sand (*)

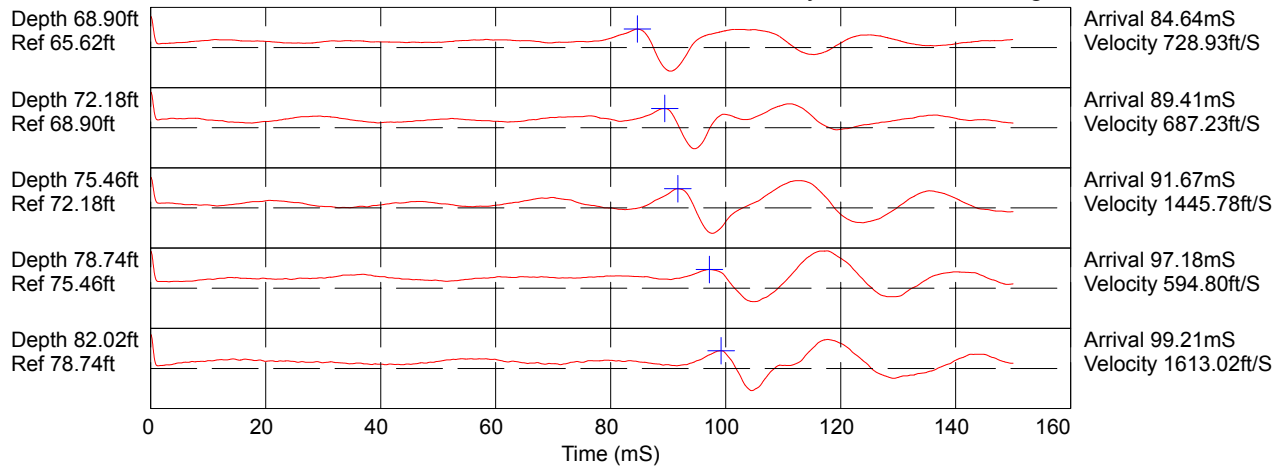
*SBT/SPT CORRELATION: UBC-1983

COMMENT: Shannon & Wilson / CPT-1 / 1400 Wynooski St Newberg



Hammer to Rod String Distance (ft): 4.27
 * = Not Determined

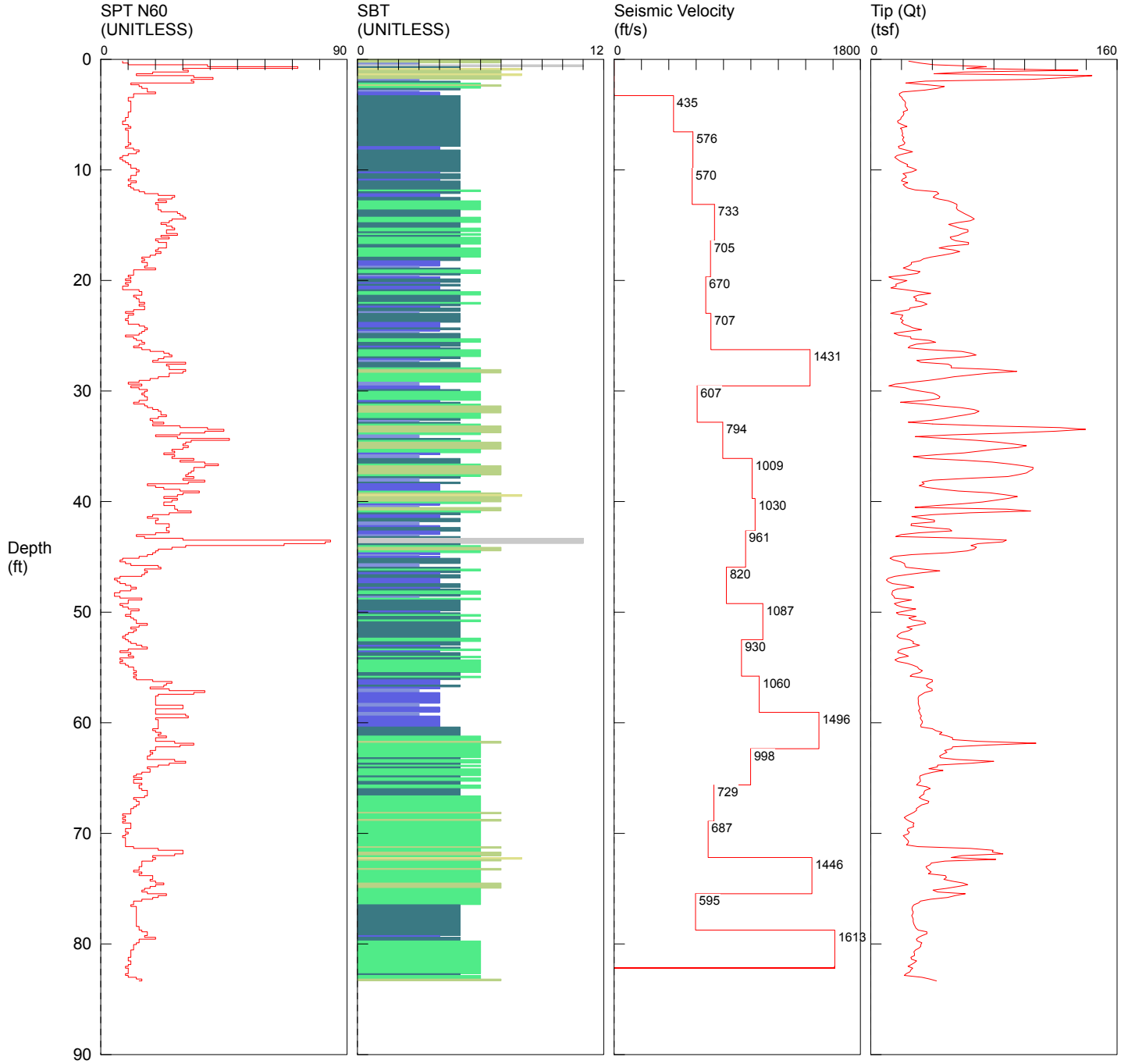
COMMENT: Shannon & Wilson / CPT-1 / 1400 Wynooski St Newberg



Hammer to Rod String Distance (ft): 4.27
* = Not Determined

Shannon & Wilson / CPT-1 / 1400 Wynooski St Newberg

OPERATOR: OGE DMM
 CONE ID: DDG1415
 HOLE NUMBER: CPT-1
 TEST DATE: 5/20/2019 8:53:04 AM
 TOTAL DEPTH: 83.333 ft

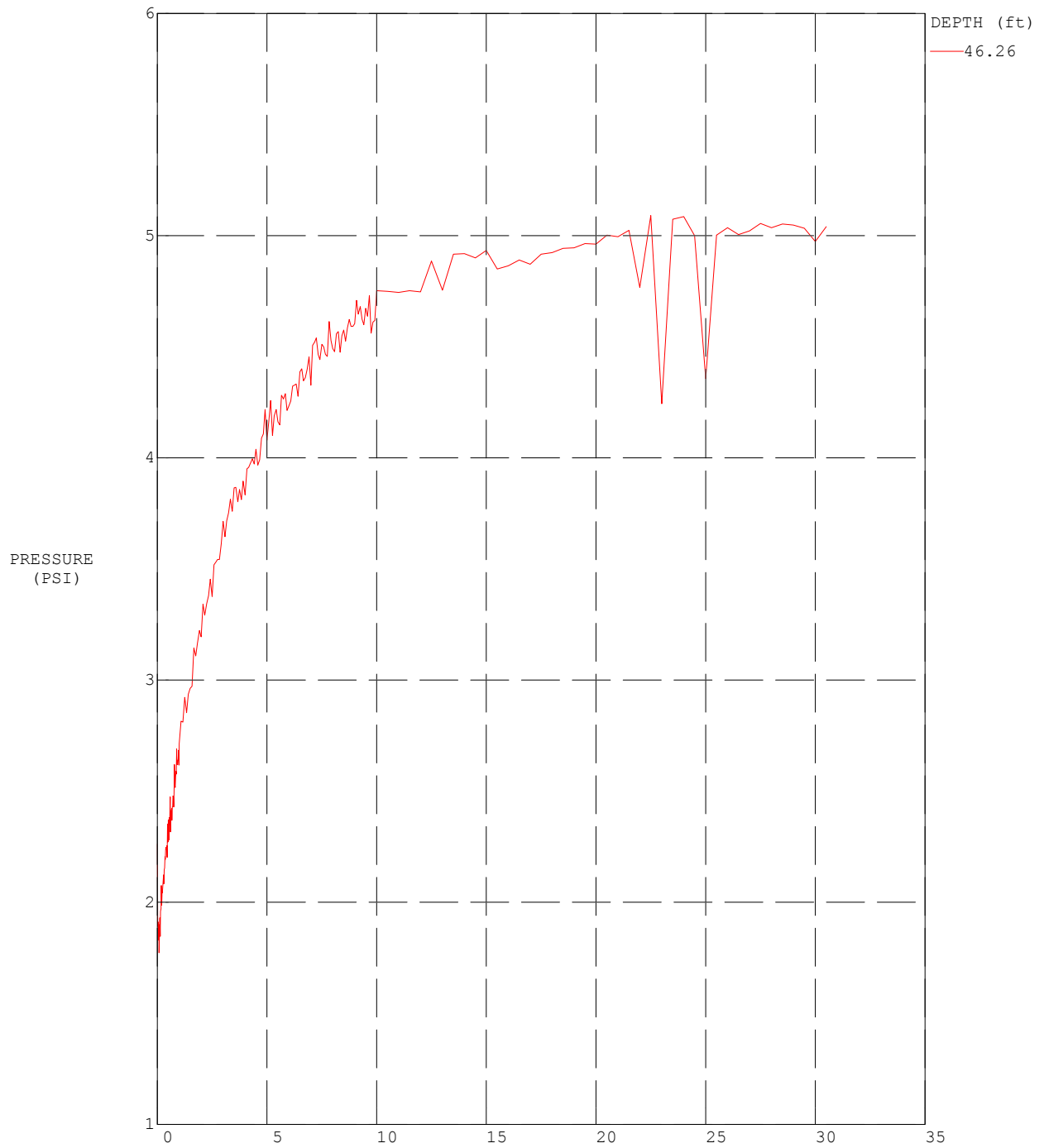


- | | | | |
|-----------------------------------------------------------------------------------------------------------------------------------------------------------------------------------------------------------------------------------|-------------------------------------------------------------------------------------------------------------------------------------------------------------------------------------------------------------------------------------------------------------------|------------------------------------------------------------------------------------------------------------------------------------------------------------------------------------------------------------------------------------------------------|--------------------------------------------------------------------------------------------------------------------------------------------------------------------------------------------------------------------------------------------------------------------------|
| <ul style="list-style-type: none"> ■ 1 sensitive fine grained ■ 2 organic material ■ 3 clay | <ul style="list-style-type: none"> ■ 4 silty clay to clay ■ 5 clayey silt to silty clay ■ 6 sandy silt to clayey silt | <ul style="list-style-type: none"> ■ 7 silty sand to sandy silt ■ 8 sand to silty sand ■ 9 sand | <ul style="list-style-type: none"> ■ 10 gravelly sand to sand ■ 11 very stiff fine grained (*) ■ 12 sand to clayey sand (*) |
|-----------------------------------------------------------------------------------------------------------------------------------------------------------------------------------------------------------------------------------|-------------------------------------------------------------------------------------------------------------------------------------------------------------------------------------------------------------------------------------------------------------------|------------------------------------------------------------------------------------------------------------------------------------------------------------------------------------------------------------------------------------------------------|--------------------------------------------------------------------------------------------------------------------------------------------------------------------------------------------------------------------------------------------------------------------------|

*SBT/SPT CORRELATION: UBC-1983

COMMENT: Shannon & Wilson / CPT-1 / 1400 Wyooski St Newberg

TEST DATE: 5/20/2019 8:53:04 AM



MAXIMUM PRESSURE = 5.091 (PSI) TIME: (MINUTES)
HYDROSTATIC PRESSURE = 5.153 (PSI), WATER TABLE: 34.37 ft

Shannon & Wilson / CPT-1 / 1400 Wynooski St Newberg

OPERATOR: OGE DMM
 CONE ID: DDG1415
 HOLE NUMBER: CPT-1
 TEST DATE: 5/20/2019 8:53:04 AM
 TOTAL DEPTH: 83.333 ft

Depth ft	Tip (Qt) (tsf)	Sleeve (Fs) (tsf)	FR (Fs/Qt) (%)	PP (U2) (psi)	SPT N60 (UNITLESS)	Zone	Soil Behavior Type UBC-1983
0.164	24.60	0.0622	0.253	-0.062	8	7	silty sand to sandy silt
0.328	31.82	0.1930	0.607	-0.227	10	7	silty sand to sandy silt
0.492	41.08	2.2819	5.554	0.041	39	3	clay
0.656	75.02	3.6534	4.870	-0.017	72	11	very stiff fine grained (*)
0.820	62.25	2.3299	3.743	1.319	30	5	clayey silt to silty clay
0.984	134.71	1.1113	0.825	1.109	32	8	sand to silty sand
1.148	61.01	0.5736	0.940	-0.083	19	7	silty sand to sandy silt
1.312	41.08	0.5810	1.414	-0.513	13	7	silty sand to sandy silt
1.476	143.70	1.6389	1.140	-0.766	34	8	sand to silty sand
1.640	128.15	2.9762	2.322	-0.907	41	7	silty sand to sandy silt
1.804	104.20	2.6030	2.498	-1.076	33	7	silty sand to sandy silt
1.969	35.50	2.6523	7.471	0.172	34	3	clay
2.133	22.80	0.7309	3.206	-0.864	11	5	clayey silt to silty clay
2.297	36.56	0.6723	1.839	-1.295	14	6	sandy silt to clayey silt
2.461	47.71	0.7708	1.615	-1.033	15	7	silty sand to sandy silt
2.625	43.23	1.0040	2.322	-1.279	17	6	sandy silt to clayey silt
2.789	35.10	1.0828	3.085	-1.143	17	5	clayey silt to silty clay
2.953	20.56	1.0142	4.933	-0.678	20	3	clay
3.117	18.45	0.7020	3.805	-0.370	12	4	silty clay to clay
3.281	18.81	0.6579	3.498	-0.229	12	4	silty clay to clay
3.445	20.24	0.6489	3.206	0.303	10	5	clayey silt to silty clay
3.609	20.72	0.6783	3.273	0.444	10	5	clayey silt to silty clay
3.773	22.04	0.7664	3.477	0.520	11	5	clayey silt to silty clay
3.937	22.58	0.7460	3.304	0.768	11	5	clayey silt to silty clay
4.101	22.23	0.7273	3.271	0.844	11	5	clayey silt to silty clay
4.265	22.46	0.7055	3.141	1.011	11	5	clayey silt to silty clay
4.429	23.39	0.7696	3.290	1.090	11	5	clayey silt to silty clay
4.593	23.91	0.7414	3.100	1.176	11	5	clayey silt to silty clay
4.757	20.97	0.7089	3.381	1.939	10	5	clayey silt to silty clay
4.921	21.57	0.6108	2.832	2.142	10	5	clayey silt to silty clay
5.085	20.99	0.5954	2.836	2.090	10	5	clayey silt to silty clay
5.249	19.68	0.5855	2.976	2.374	9	5	clayey silt to silty clay
5.413	19.40	0.5142	2.650	2.502	9	5	clayey silt to silty clay
5.577	17.34	0.4606	2.656	2.634	8	5	clayey silt to silty clay
5.741	17.74	0.4483	2.528	2.846	8	5	clayey silt to silty clay
5.906	20.34	0.6701	3.294	3.120	10	5	clayey silt to silty clay
6.070	23.53	0.6957	2.957	3.178	11	5	clayey silt to silty clay
6.234	19.24	0.5943	3.089	2.996	9	5	clayey silt to silty clay
6.398	20.20	0.6450	3.193	3.204	10	5	clayey silt to silty clay
6.562	20.36	0.6811	3.345	3.342	10	5	clayey silt to silty clay
6.726	20.76	0.6454	3.108	4.635	10	5	clayey silt to silty clay
6.890	20.32	0.6577	3.237	4.564	10	5	clayey silt to silty clay
7.054	21.59	0.6393	2.961	4.735	10	5	clayey silt to silty clay
7.218	20.71	0.6350	3.067	4.840	10	5	clayey silt to silty clay

Depth ft	Tip (Qt) (tsf)	Sleeve (Fs) (tsf)	FR (Fs/Qt) (%)	PP (U2) (psi)	SPT N60 (UNITLESS)	Zone	Soil Behavior Type UBC-1983
7.382	21.13	0.5897	2.791	4.921	10	5	clayey silt to silty clay
7.546	22.20	0.6171	2.780	5.041	11	5	clayey silt to silty clay
7.710	21.38	0.5368	2.511	5.189	10	5	clayey silt to silty clay
7.874	17.92	0.5527	3.084	5.403	9	5	clayey silt to silty clay
8.038	18.40	0.6279	3.412	6.429	12	4	silty clay to clay
8.202	22.65	0.8339	3.681	6.913	14	4	silty clay to clay
8.366	27.18	0.9667	3.557	6.599	13	5	clayey silt to silty clay
8.530	21.65	0.7373	3.406	5.666	10	5	clayey silt to silty clay
8.694	16.97	0.4347	2.562	5.911	8	5	clayey silt to silty clay
8.858	15.55	0.3548	2.282	6.508	7	5	clayey silt to silty clay
9.022	17.16	0.4414	2.573	6.508	8	5	clayey silt to silty clay
9.186	18.81	0.5287	2.812	6.823	9	5	clayey silt to silty clay
9.350	21.02	0.6379	3.035	7.002	10	5	clayey silt to silty clay
9.514	23.89	0.7437	3.113	7.009	11	5	clayey silt to silty clay
9.678	23.44	0.8060	3.439	7.042	11	5	clayey silt to silty clay
9.843	27.18	0.9241	3.400	7.040	13	5	clayey silt to silty clay
10.007	29.74	1.0398	3.496	7.307	14	5	clayey silt to silty clay
10.171	26.71	0.9453	3.539	6.880	13	5	clayey silt to silty clay
10.335	20.89	0.7377	3.532	6.885	13	4	silty clay to clay
10.499	22.61	0.6975	3.085	7.052	11	5	clayey silt to silty clay
10.663	23.06	0.6785	2.942	7.033	11	5	clayey silt to silty clay
10.827	20.70	0.6746	3.259	7.135	10	5	clayey silt to silty clay
10.991	19.94	0.7672	3.848	7.474	13	4	silty clay to clay
11.155	24.02	0.7609	3.168	7.493	11	5	clayey silt to silty clay
11.319	20.98	0.6767	3.226	7.190	10	5	clayey silt to silty clay
11.483	22.16	0.6516	2.940	7.727	11	5	clayey silt to silty clay
11.647	24.04	0.7749	3.224	8.113	12	5	clayey silt to silty clay
11.811	28.76	0.8801	3.060	8.242	14	5	clayey silt to silty clay
11.975	42.82	1.1127	2.598	7.970	16	6	sandy silt to clayey silt
12.139	44.11	1.4028	3.180	6.737	21	5	clayey silt to silty clay
12.303	41.80	1.7399	4.163	5.725	27	4	silty clay to clay
12.467	40.59	1.8652	4.596	5.103	26	4	silty clay to clay
12.631	44.08	1.7726	4.021	4.514	21	5	clayey silt to silty clay
12.795	50.15	1.7265	3.443	4.335	24	5	clayey silt to silty clay
12.959	53.51	1.5832	2.958	4.060	20	6	sandy silt to clayey silt
13.123	55.95	1.4325	2.560	3.631	21	6	sandy silt to clayey silt
13.287	56.01	1.4940	2.668	2.643	21	6	sandy silt to clayey silt
13.451	55.56	1.5843	2.851	2.467	21	6	sandy silt to clayey silt
13.615	56.44	1.6915	2.997	2.331	22	6	sandy silt to clayey silt
13.780	58.70	2.1163	3.605	2.307	28	5	clayey silt to silty clay
13.944	60.71	2.4573	4.048	2.247	29	5	clayey silt to silty clay
14.108	63.16	2.7152	4.299	2.538	30	5	clayey silt to silty clay
14.272	65.49	2.2713	3.468	2.586	31	5	clayey silt to silty clay
14.436	67.25	1.7454	2.595	2.450	26	6	sandy silt to clayey silt
14.600	64.66	1.6142	2.497	1.823	25	6	sandy silt to clayey silt
14.764	56.27	1.5834	2.814	1.699	22	6	sandy silt to clayey silt
14.928	50.51	1.6273	3.222	1.443	24	5	clayey silt to silty clay
15.092	53.95	1.8281	3.388	1.691	26	5	clayey silt to silty clay
15.256	57.40	1.9561	3.408	1.694	27	5	clayey silt to silty clay
15.420	63.06	1.9666	3.118	1.761	24	6	sandy silt to clayey silt
15.584	63.17	2.0417	3.232	1.656	24	6	sandy silt to clayey silt
15.748	59.42	1.9729	3.320	1.694	28	5	clayey silt to silty clay
15.912	56.78	1.8623	3.280	1.629	22	6	sandy silt to clayey silt

Depth ft	Tip (Qt) (tsf)	Sleeve (Fs) (tsf)	FR (Fs/Qt) (%)	PP (U2) (psi)	SPT N60 (UNITLESS)	Zone	Soil Behavior Type UBC-1983
16.076	51.58	1.6901	3.277	1.522	25	5	clayey silt to silty clay
16.240	52.19	1.6505	3.163	1.653	20	6	sandy silt to clayey silt
16.404	55.21	1.6575	3.002	1.622	21	6	sandy silt to clayey silt
16.568	63.47	1.9421	3.060	1.226	24	6	sandy silt to clayey silt
16.732	63.41	1.8617	2.936	1.272	24	6	sandy silt to clayey silt
16.896	50.04	1.6180	3.233	1.293	24	5	clayey silt to silty clay
17.060	44.34	1.5462	3.487	1.338	21	5	clayey silt to silty clay
17.224	53.33	1.5380	2.884	1.572	20	6	sandy silt to clayey silt
17.388	57.76	1.4418	2.496	1.462	22	6	sandy silt to clayey silt
17.552	52.51	1.0729	2.043	1.291	20	6	sandy silt to clayey silt
17.717	46.38	1.0428	2.248	1.152	18	6	sandy silt to clayey silt
17.881	38.98	0.9845	2.525	0.949	15	6	sandy silt to clayey silt
18.045	34.20	1.0301	3.012	1.040	16	5	clayey silt to silty clay
18.209	32.15	1.0746	3.342	1.042	15	5	clayey silt to silty clay
18.373	26.40	1.1092	4.202	1.331	17	4	silty clay to clay
18.537	26.39	1.0903	4.131	1.241	17	4	silty clay to clay
18.701	24.38	1.0311	4.229	1.283	16	4	silty clay to clay
18.865	21.09	0.9431	4.472	1.367	20	3	clay
19.029	24.99	0.8323	3.331	1.558	12	5	clayey silt to silty clay
19.193	31.91	0.8014	2.512	1.741	12	6	sandy silt to clayey silt
19.357	30.19	0.7788	2.580	1.470	12	6	sandy silt to clayey silt
19.521	21.43	0.6272	2.927	1.353	10	5	clayey silt to silty clay
19.685	11.70	0.4823	4.124	1.307	11	3	clay
19.849	14.84	0.4800	3.235	1.813	9	4	silty clay to clay
20.013	23.44	0.5968	2.545	1.930	11	5	clayey silt to silty clay
20.177	19.75	0.6841	3.463	2.016	9	5	clayey silt to silty clay
20.341	16.28	0.6064	3.724	2.042	10	4	silty clay to clay
20.505	16.48	0.4210	2.554	2.307	8	5	clayey silt to silty clay
20.669	13.07	0.4769	3.648	2.505	8	4	silty clay to clay
20.833	22.43	0.9265	4.131	2.987	14	4	silty clay to clay
20.997	31.09	0.9946	3.200	2.834	15	5	clayey silt to silty clay
21.161	38.92	0.9388	2.412	2.164	15	6	sandy silt to clayey silt
21.325	30.77	0.8459	2.749	1.997	12	6	sandy silt to clayey silt
21.490	27.72	0.7732	2.790	1.997	13	5	clayey silt to silty clay
21.654	29.69	0.9653	3.252	1.987	14	5	clayey silt to silty clay
21.818	29.04	0.9813	3.379	2.068	14	5	clayey silt to silty clay
21.982	34.01	1.0231	3.008	2.240	16	5	clayey silt to silty clay
22.146	36.43	1.0117	2.777	2.142	14	6	sandy silt to clayey silt
22.310	32.87	1.0274	3.125	2.056	16	5	clayey silt to silty clay
22.474	25.43	0.9953	3.914	2.080	16	4	silty clay to clay
22.638	24.99	0.6760	2.705	2.142	12	5	clayey silt to silty clay
22.802	17.86	0.5661	3.170	2.333	9	5	clayey silt to silty clay
22.966	12.83	0.5039	3.928	2.696	12	3	clay
23.130	20.78	0.5702	2.744	5.327	10	5	clayey silt to silty clay
23.294	20.25	0.5671	2.800	5.096	10	5	clayey silt to silty clay
23.458	19.18	0.5660	2.952	5.177	9	5	clayey silt to silty clay
23.622	21.02	0.5469	2.602	5.437	10	5	clayey silt to silty clay
23.786	19.87	0.6769	3.406	5.740	10	5	clayey silt to silty clay
23.950	21.39	0.7768	3.631	5.942	14	4	silty clay to clay
24.114	24.70	0.9534	3.859	6.000	16	4	silty clay to clay
24.278	27.27	1.0255	3.761	6.100	17	4	silty clay to clay
24.442	33.01	1.0320	3.126	4.003	16	5	clayey silt to silty clay
24.606	23.56	0.9135	3.877	2.579	15	4	silty clay to clay

Depth ft	Tip (Qt) (tsf)	Sleeve (Fs) (tsf)	FR (Fs/Qt) (%)	PP (U2) (psi)	SPT N60 (UNITLESS)	Zone	Soil Behavior Type UBC-1983
24.770	15.12	0.6720	4.443	2.262	14	3	clay
24.934	17.85	0.5940	3.327	2.724	9	5	clayey silt to silty clay
25.098	25.99	0.7628	2.935	3.008	12	5	clayey silt to silty clay
25.262	26.13	0.8502	3.254	3.065	13	5	clayey silt to silty clay
25.427	38.00	0.9549	2.513	3.149	15	6	sandy silt to clayey silt
25.591	42.16	1.1705	2.777	2.686	16	6	sandy silt to clayey silt
25.755	29.57	1.1182	3.781	2.550	14	5	clayey silt to silty clay
25.919	25.58	0.8702	3.402	2.486	12	5	clayey silt to silty clay
26.083	24.24	1.0096	4.166	2.801	15	4	silty clay to clay
26.247	37.82	1.3721	3.628	3.099	18	5	clayey silt to silty clay
26.411	58.97	1.6422	2.785	2.712	23	6	sandy silt to clayey silt
26.575	64.95	1.6129	2.483	1.956	25	6	sandy silt to clayey silt
26.739	68.38	1.6044	2.346	1.889	26	6	sandy silt to clayey silt
26.903	60.84	1.5816	2.600	1.665	23	6	sandy silt to clayey silt
27.067	43.77	1.5107	3.451	1.689	21	5	clayey silt to silty clay
27.231	29.87	1.3056	4.372	1.546	19	4	silty clay to clay
27.395	32.52	1.5536	4.777	2.133	31	3	clay
27.559	50.27	1.8122	3.605	2.531	24	5	clayey silt to silty clay
27.723	52.41	1.9482	3.718	1.520	25	5	clayey silt to silty clay
27.887	52.15	2.0945	4.016	1.582	25	5	clayey silt to silty clay
28.051	80.75	2.0431	2.530	1.491	31	6	sandy silt to clayey silt
28.215	94.79	1.9232	2.029	1.255	30	7	silty sand to sandy silt
28.379	76.95	1.6433	2.136	1.033	25	7	silty sand to sandy silt
28.543	65.02	1.5683	2.412	0.878	25	6	sandy silt to clayey silt
28.707	54.05	1.4457	2.675	0.995	21	6	sandy silt to clayey silt
28.871	46.74	1.3080	2.798	0.813	18	6	sandy silt to clayey silt
29.035	37.73	1.1023	2.921	0.830	14	6	sandy silt to clayey silt
29.199	26.55	0.6245	2.353	0.818	10	6	sandy silt to clayey silt
29.364	15.83	0.6953	4.392	1.042	15	3	clay
29.528	11.71	0.7334	6.261	2.505	11	3	clay
29.692	22.19	0.8950	4.034	5.317	14	4	silty clay to clay
29.856	25.87	1.0467	4.047	4.838	17	4	silty clay to clay
30.020	32.83	1.0763	3.279	4.067	16	5	clayey silt to silty clay
30.184	40.43	0.9766	2.416	2.972	15	6	sandy silt to clayey silt
30.348	43.05	0.8651	2.010	2.557	16	6	sandy silt to clayey silt
30.512	44.90	0.8311	1.851	2.314	17	6	sandy silt to clayey silt
30.676	44.26	0.8723	1.971	2.047	17	6	sandy silt to clayey silt
30.840	35.80	0.8375	2.339	1.959	14	6	sandy silt to clayey silt
31.004	19.24	0.7027	3.652	2.185	12	4	silty clay to clay
31.168	33.30	0.9977	2.996	2.615	16	5	clayey silt to silty clay
31.332	44.91	1.2435	2.769	2.269	17	6	sandy silt to clayey silt
31.496	58.41	1.1391	1.950	1.746	19	7	silty sand to sandy silt
31.660	66.86	1.1863	1.774	1.214	21	7	silty sand to sandy silt
31.824	70.36	1.3122	1.865	0.949	22	7	silty sand to sandy silt
31.988	67.74	1.4215	2.098	0.868	22	7	silty sand to sandy silt
32.152	61.58	1.3438	2.182	0.854	24	6	sandy silt to clayey silt
32.316	54.44	1.2182	2.238	0.945	21	6	sandy silt to clayey silt
32.480	47.79	1.2267	2.567	0.811	18	6	sandy silt to clayey silt
32.644	38.93	1.2187	3.130	1.095	19	5	clayey silt to silty clay
32.808	24.36	1.2348	5.069	1.629	23	3	clay
32.972	40.25	1.3508	3.356	1.856	19	5	clayey silt to silty clay
33.136	75.54	2.0677	2.737	2.152	29	6	sandy silt to clayey silt
33.301	122.83	2.6863	2.187	1.751	39	7	silty sand to sandy silt

Depth ft	Tip (Qt) (tsf)	Sleeve (Fs) (tsf)	FR (Fs/Qt) (%)	PP (U2) (psi)	SPT N60 (UNITLESS)	Zone	Soil Behavior Type UBC-1983
33.465	139.48	2.8496	2.043	0.792	45	7	silty sand to sandy silt
33.629	119.94	2.2982	1.916	0.074	38	7	silty sand to sandy silt
33.793	91.38	2.1639	2.368	-0.219	29	7	silty sand to sandy silt
33.957	52.68	1.5924	3.023	-0.439	20	6	sandy silt to clayey silt
34.121	28.84	1.7126	5.937	-0.427	28	3	clay
34.285	48.78	2.5983	5.326	1.970	47	3	clay
34.449	68.50	2.7565	4.024	1.949	33	5	clayey silt to silty clay
34.613	82.08	2.4348	2.966	0.542	31	6	sandy silt to clayey silt
34.777	92.49	1.9056	2.060	-0.253	30	7	silty sand to sandy silt
34.941	101.12	1.6294	1.611	-0.685	32	7	silty sand to sandy silt
35.105	95.30	1.6938	1.777	-0.871	30	7	silty sand to sandy silt
35.269	80.33	1.6628	2.070	-1.150	26	7	silty sand to sandy silt
35.433	70.10	1.6484	2.351	-1.102	27	6	sandy silt to clayey silt
35.597	60.46	1.7217	2.848	-0.971	23	6	sandy silt to clayey silt
35.761	42.87	1.8923	4.414	-0.985	27	4	silty clay to clay
35.925	27.57	1.6144	5.856	-0.842	26	3	clay
36.089	35.86	1.9770	5.513	-0.494	34	3	clay
36.253	60.84	2.6494	4.355	0.396	29	5	clayey silt to silty clay
36.417	78.74	3.1976	4.061	0.119	38	5	clayey silt to silty clay
36.581	89.95	3.4395	3.824	-0.506	43	5	clayey silt to silty clay
36.745	98.65	2.7649	2.803	-0.942	38	6	sandy silt to clayey silt
36.909	105.48	2.0601	1.953	-1.202	34	7	silty sand to sandy silt
37.073	105.25	1.8285	1.737	-1.813	34	7	silty sand to sandy silt
37.238	103.02	2.0758	2.015	-1.861	33	7	silty sand to sandy silt
37.402	101.14	2.1933	2.169	-1.894	32	7	silty sand to sandy silt
37.566	95.81	2.2338	2.331	-1.687	31	7	silty sand to sandy silt
37.730	89.07	2.5177	2.826	-1.591	34	6	sandy silt to clayey silt
37.894	61.70	2.3272	3.772	-1.510	30	5	clayey silt to silty clay
38.058	39.95	1.9602	4.907	-1.388	38	3	clay
38.222	33.24	1.6147	4.858	-0.971	32	3	clay
38.386	34.70	1.2804	3.690	-0.389	17	5	clayey silt to silty clay
38.550	31.43	1.3809	4.394	-0.210	20	4	silty clay to clay
38.714	36.37	1.5129	4.160	-0.138	23	4	silty clay to clay
38.878	45.84	2.1410	4.671	-0.103	29	4	silty clay to clay
39.042	56.95	2.5994	4.564	-0.005	36	4	silty clay to clay
39.206	77.21	2.0706	2.682	-0.239	30	6	sandy silt to clayey silt
39.370	86.90	1.3783	1.586	-0.904	28	7	silty sand to sandy silt
39.534	95.21	1.1668	1.225	-1.570	23	8	sand to silty sand
39.698	89.27	1.3477	1.510	-1.727	28	7	silty sand to sandy silt
39.862	81.06	1.4491	1.788	-0.942	26	7	silty sand to sandy silt
40.026	72.43	1.5291	2.111	-0.835	23	7	silty sand to sandy silt
40.190	59.38	1.7874	3.010	-0.902	23	6	sandy silt to clayey silt
40.354	42.54	1.9077	4.485	-0.828	27	4	silty clay to clay
40.518	28.71	1.6242	5.658	-0.589	27	3	clay
40.682	88.33	1.8752	2.123	0.856	28	7	silty sand to sandy silt
40.846	103.89	2.1595	2.079	-0.439	33	7	silty sand to sandy silt
41.011	64.58	2.0212	3.130	-0.749	25	6	sandy silt to clayey silt
41.175	40.24	1.2596	3.130	-1.000	19	5	clayey silt to silty clay
41.339	26.57	1.0749	4.045	-0.615	17	4	silty clay to clay
41.503	33.12	1.3238	3.997	0.358	21	4	silty clay to clay
41.667	41.34	1.6260	3.934	0.482	20	5	clayey silt to silty clay
41.831	41.31	1.5810	3.827	0.456	20	5	clayey silt to silty clay
41.995	26.39	1.3696	5.190	-0.076	25	3	clay

Depth ft	Tip (Qt) (tsf)	Sleeve (Fs) (tsf)	FR (Fs/Qt) (%)	PP (U2) (psi)	SPT N60 (UNITLESS)	Zone	Soil Behavior Type UBC-1983
42.159	26.07	1.3757	5.277	-0.088	25	3	clay
42.323	37.22	1.7734	4.765	0.079	24	4	silty clay to clay
42.487	51.04	2.0687	4.053	0.236	24	5	clayey silt to silty clay
42.651	52.59	1.8933	3.600	-0.157	25	5	clayey silt to silty clay
42.815	31.44	1.3683	4.352	-0.021	20	4	silty clay to clay
42.979	19.67	0.6953	3.535	-0.386	13	4	silty clay to clay
43.143	16.25	1.1342	6.980	0.265	16	3	clay
43.307	62.86	2.6705	4.248	1.023	30	5	clayey silt to silty clay
43.471	88.14	4.3772	4.966	1.038	84	11	very stiff fine grained (*)
43.635	85.77	4.7623	5.553	0.604	82	11	very stiff fine grained (*)
43.799	69.66	4.1405	5.944	0.394	67	11	very stiff fine grained (*)
43.963	65.06	2.8777	4.423	0.231	31	5	clayey silt to silty clay
44.127	68.67	1.7510	2.550	-0.468	26	6	sandy silt to clayey silt
44.291	67.16	1.0060	1.498	-1.071	21	7	silty sand to sandy silt
44.455	62.69	1.0552	1.683	-1.589	20	7	silty sand to sandy silt
44.619	50.22	1.3561	2.700	-1.777	19	6	sandy silt to clayey silt
44.783	26.59	1.1804	4.440	-1.703	17	4	silty clay to clay
44.948	14.98	0.7302	4.873	-1.202	14	3	clay
45.112	12.46	0.3855	3.095	-0.253	8	4	silty clay to clay
45.276	14.77	0.4274	2.894	0.577	7	5	clayey silt to silty clay
45.440	19.59	0.5934	3.030	1.272	9	5	clayey silt to silty clay
45.604	21.97	0.5897	2.683	1.496	11	5	clayey silt to silty clay
45.768	22.14	1.1226	5.071	1.730	21	3	clay
45.932	22.77	1.1297	4.962	1.982	22	3	clay
46.096	33.16	1.0166	3.066	2.872	16	5	clayey silt to silty clay
46.260	44.85	1.0325	2.302	2.135	17	6	sandy silt to clayey silt
46.424	33.23	1.0222	3.076	3.502	16	5	clayey silt to silty clay
46.588	23.70	0.8736	3.687	3.507	15	4	silty clay to clay
46.752	15.59	0.4744	3.042	4.158	7	5	clayey silt to silty clay
46.916	11.41	0.1857	1.628	5.644	5	5	clayey silt to silty clay
47.080	10.13	0.3142	3.102	6.837	6	4	silty clay to clay
47.244	11.33	0.3757	3.316	8.113	7	4	silty clay to clay
47.408	14.04	0.4648	3.310	11.038	9	4	silty clay to clay
47.572	22.60	0.6969	3.083	12.205	11	5	clayey silt to silty clay
47.736	27.96	0.7814	2.795	10.594	13	5	clayey silt to silty clay
47.900	17.30	0.6627	3.831	11.873	11	4	silty clay to clay
48.064	14.29	0.2979	2.085	13.359	7	5	clayey silt to silty clay
48.228	13.89	0.1869	1.346	15.282	5	6	sandy silt to clayey silt
48.392	13.64	0.1842	1.350	17.269	5	6	sandy silt to clayey silt
48.556	14.95	0.2856	1.910	18.796	7	5	clayey silt to silty clay
48.720	15.37	0.6200	4.033	20.189	15	3	clay
48.885	26.31	0.6264	2.381	20.325	10	6	sandy silt to clayey silt
49.049	20.05	0.6077	3.031	13.665	10	5	clayey silt to silty clay
49.213	15.26	0.4382	2.872	15.120	7	5	clayey silt to silty clay
49.377	17.00	0.4567	2.686	22.420	8	5	clayey silt to silty clay
49.541	20.51	0.6408	3.124	25.466	10	5	clayey silt to silty clay
49.705	29.13	0.8073	2.771	26.375	14	5	clayey silt to silty clay
49.869	23.09	0.6827	2.957	25.321	11	5	clayey silt to silty clay
50.033	16.65	0.5776	3.469	26.928	11	4	silty clay to clay
50.197	18.24	0.4015	2.201	31.585	9	5	clayey silt to silty clay
50.361	29.48	0.5944	2.017	30.294	11	6	sandy silt to clayey silt
50.525	24.68	0.6305	2.555	23.906	12	5	clayey silt to silty clay
50.689	26.89	0.8155	3.033	36.084	13	5	clayey silt to silty clay

Depth ft	Tip (Qt) (tsf)	Sleeve (Fs) (tsf)	FR (Fs/Qt) (%)	PP (U2) (psi)	SPT N60 (UNITLESS)	Zone	Soil Behavior Type UBC-1983
50.853	34.90	0.9952	2.851	37.117	13	6	sandy silt to clayey silt
51.017	35.61	1.0403	2.921	32.551	17	5	clayey silt to silty clay
51.181	29.92	0.9293	3.106	28.548	14	5	clayey silt to silty clay
51.345	23.42	0.8057	3.440	28.897	11	5	clayey silt to silty clay
51.509	26.83	0.8410	3.135	32.606	13	5	clayey silt to silty clay
51.673	24.39	0.7881	3.231	29.727	12	5	clayey silt to silty clay
51.837	19.97	0.5289	2.649	29.033	10	5	clayey silt to silty clay
52.001	17.95	0.3668	2.044	31.330	9	5	clayey silt to silty clay
52.165	16.94	0.2982	1.760	35.056	8	5	clayey silt to silty clay
52.329	18.75	0.5998	3.199	38.840	9	5	clayey silt to silty clay
52.493	25.30	0.5495	2.172	43.260	10	6	sandy silt to clayey silt
52.657	27.75	0.7104	2.560	22.756	11	6	sandy silt to clayey silt
52.822	27.38	0.8186	2.989	27.549	13	5	clayey silt to silty clay
52.986	31.73	0.9711	3.060	28.512	15	5	clayey silt to silty clay
53.150	26.87	1.0057	3.742	27.463	17	4	silty clay to clay
53.314	20.38	0.5987	2.939	28.038	10	5	clayey silt to silty clay
53.478	17.91	0.3091	1.726	30.710	7	6	sandy silt to clayey silt
53.642	17.52	0.6089	3.474	34.398	11	4	silty clay to clay
53.806	21.66	0.7555	3.488	37.675	10	5	clayey silt to silty clay
53.970	24.49	0.7032	2.871	43.950	12	5	clayey silt to silty clay
54.134	18.33	0.3276	1.788	48.189	7	6	sandy silt to clayey silt
54.298	15.68	0.2611	1.665	51.164	8	5	clayey silt to silty clay
54.462	17.50	0.2859	1.634	56.805	7	6	sandy silt to clayey silt
54.626	23.71	0.3866	1.630	61.474	9	6	sandy silt to clayey silt
54.790	27.29	0.5617	2.058	66.128	10	6	sandy silt to clayey silt
54.954	30.32	0.6981	2.302	69.101	12	6	sandy silt to clayey silt
55.118	31.19	0.7112	2.280	72.264	12	6	sandy silt to clayey silt
55.282	33.48	0.7381	2.205	84.159	13	6	sandy silt to clayey silt
55.446	31.89	0.7442	2.334	84.457	12	6	sandy silt to clayey silt
55.610	27.15	0.7923	2.919	79.285	13	5	clayey silt to silty clay
55.774	25.58	0.6817	2.665	81.382	12	5	clayey silt to silty clay
55.938	34.13	0.8871	2.599	97.222	13	6	sandy silt to clayey silt
56.102	39.91	1.2276	3.076	102.198	19	5	clayey silt to silty clay
56.266	40.05	1.6705	4.171	76.126	26	4	silty clay to clay
56.430	37.77	1.6509	4.371	75.289	24	4	silty clay to clay
56.594	36.02	1.4514	4.029	79.197	23	4	silty clay to clay
56.759	36.84	1.4424	3.915	86.289	18	5	clayey silt to silty clay
56.923	39.72	1.8423	4.638	85.702	25	4	silty clay to clay
57.087	39.96	1.9557	4.894	72.030	38	3	clay
57.251	35.11	1.6788	4.782	46.533	34	3	clay
57.415	33.27	1.4429	4.337	47.805	21	4	silty clay to clay
57.579	31.33	1.3501	4.309	50.383	20	4	silty clay to clay
57.743	30.71	1.2652	4.120	52.800	20	4	silty clay to clay
57.907	30.81	1.2413	4.028	54.856	20	4	silty clay to clay
58.071	30.87	1.2822	4.153	56.030	20	4	silty clay to clay
58.235	30.83	1.3761	4.464	53.501	20	4	silty clay to clay
58.399	31.08	1.4960	4.813	54.465	30	3	clay
58.563	31.67	1.5922	5.028	51.094	30	3	clay
58.727	31.90	1.4141	4.433	52.321	20	4	silty clay to clay
58.891	30.98	1.4277	4.608	54.239	20	4	silty clay to clay
59.055	31.72	1.3988	4.410	55.472	20	4	silty clay to clay
59.219	32.04	1.5475	4.829	54.470	31	3	clay
59.383	32.96	1.5587	4.729	54.551	32	3	clay

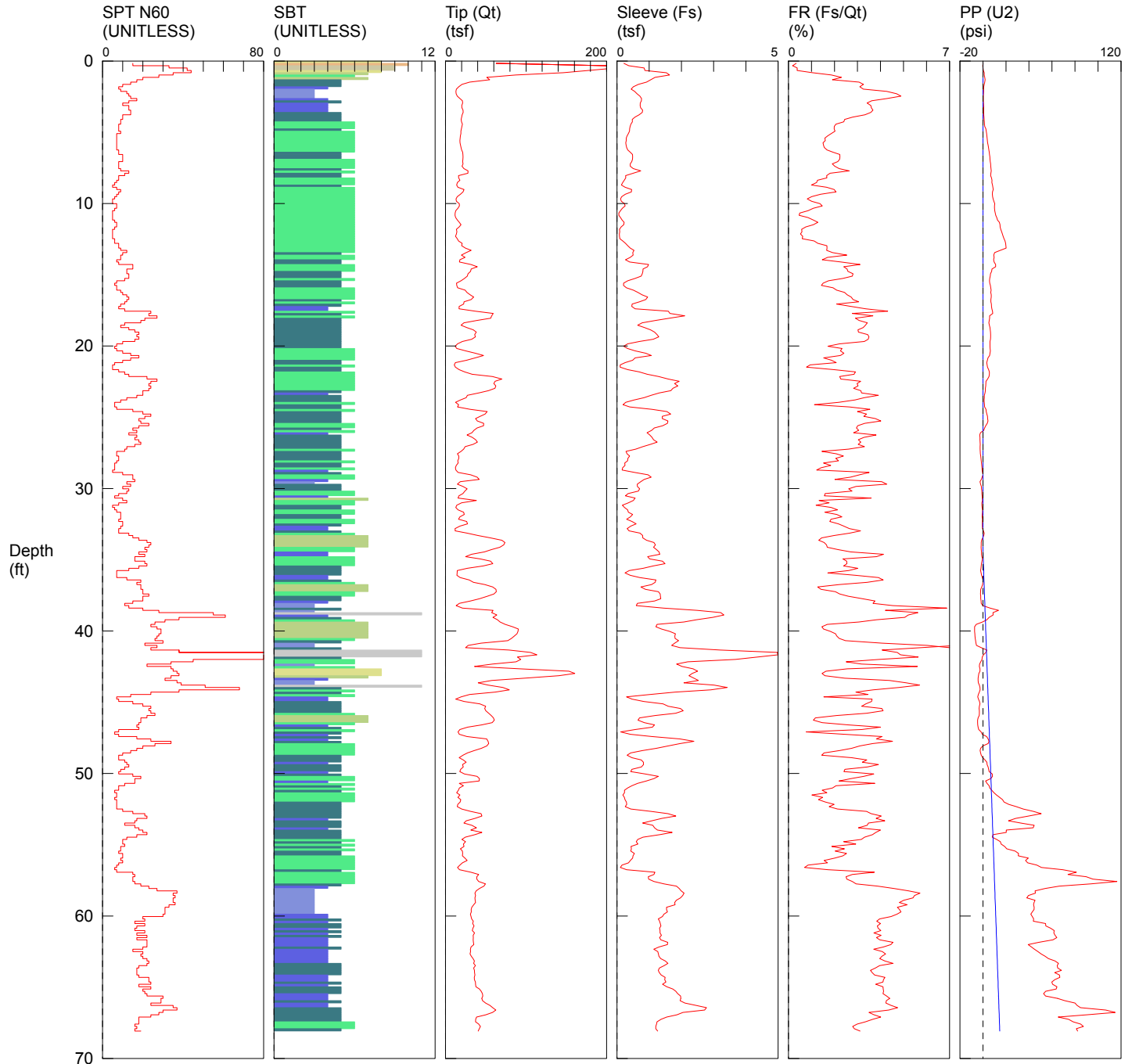
Depth ft	Tip (Qt) (tsf)	Sleeve (Fs) (tsf)	FR (Fs/Qt) (%)	PP (U2) (psi)	SPT N60 (UNITLESS)	Zone	Soil Behavior Type UBC-1983
59.547	32.10	1.4922	4.648	54.790	20	4	silty clay to clay
59.711	32.65	1.4739	4.515	56.095	21	4	silty clay to clay
59.875	33.55	1.4614	4.356	57.199	21	4	silty clay to clay
60.039	33.35	1.4333	4.299	57.357	21	4	silty clay to clay
60.203	32.41	1.4213	4.386	58.363	21	4	silty clay to clay
60.367	32.63	1.4613	4.479	61.414	21	4	silty clay to clay
60.532	40.04	1.4552	3.634	84.466	19	5	clayey silt to silty clay
60.696	42.16	1.6986	4.029	91.773	20	5	clayey silt to silty clay
60.860	46.28	1.5414	3.330	97.148	22	5	clayey silt to silty clay
61.024	44.62	1.5837	3.549	111.710	21	5	clayey silt to silty clay
61.188	49.67	1.5857	3.193	123.337	24	5	clayey silt to silty clay
61.352	53.13	1.5277	2.876	128.678	20	6	sandy silt to clayey silt
61.516	53.05	1.6461	3.103	143.087	20	6	sandy silt to clayey silt
61.680	70.20	2.1418	3.051	177.800	27	6	sandy silt to clayey silt
61.844	107.35	2.5619	2.387	90.483	34	7	silty sand to sandy silt
62.008	75.11	2.0736	2.761	20.351	29	6	sandy silt to clayey silt
62.172	53.20	1.5707	2.952	29.918	20	6	sandy silt to clayey silt
62.336	52.52	1.4678	2.795	30.655	20	6	sandy silt to clayey silt
62.500	47.96	1.4893	3.105	39.028	18	6	sandy silt to clayey silt
62.664	49.51	1.4468	2.923	43.766	19	6	sandy silt to clayey silt
62.828	46.96	1.2791	2.724	42.203	18	6	sandy silt to clayey silt
62.992	44.71	1.1564	2.586	44.508	17	6	sandy silt to clayey silt
63.156	45.22	1.2324	2.725	46.466	17	6	sandy silt to clayey silt
63.320	55.36	2.0795	3.757	49.312	27	5	clayey silt to silty clay
63.484	79.90	2.2161	2.773	43.456	31	6	sandy silt to clayey silt
63.648	65.46	1.9192	2.932	37.718	25	6	sandy silt to clayey silt
63.812	43.39	1.5764	3.633	44.567	21	5	clayey silt to silty clay
63.976	43.26	1.1280	2.607	41.977	17	6	sandy silt to clayey silt
64.140	37.76	1.1674	3.091	46.994	18	5	clayey silt to silty clay
64.304	46.91	0.9646	2.056	49.534	18	6	sandy silt to clayey silt
64.469	40.38	0.9050	2.241	47.523	15	6	sandy silt to clayey silt
64.633	35.24	0.8590	2.438	51.507	13	6	sandy silt to clayey silt
64.797	32.08	0.8564	2.670	51.724	12	6	sandy silt to clayey silt
64.961	31.71	0.9986	3.149	50.691	15	5	clayey silt to silty clay
65.125	32.10	0.8250	2.570	52.082	12	6	sandy silt to clayey silt
65.289	32.28	0.7296	2.260	53.320	12	6	sandy silt to clayey silt
65.453	30.80	0.8938	2.902	54.747	15	5	clayey silt to silty clay
65.617	29.70	0.8391	2.825	56.514	14	5	clayey silt to silty clay
65.781	36.25	1.0293	2.839	65.668	14	6	sandy silt to clayey silt
65.945	38.62	1.1280	2.921	64.773	15	6	sandy silt to clayey silt
66.109	35.31	1.3677	3.874	66.097	17	5	clayey silt to silty clay
66.273	34.58	1.2528	3.623	65.658	17	5	clayey silt to silty clay
66.437	34.57	1.1421	3.303	67.054	17	5	clayey silt to silty clay
66.601	32.75	0.9857	3.009	68.220	16	5	clayey silt to silty clay
66.765	31.44	0.8181	2.602	70.546	12	6	sandy silt to clayey silt
66.929	33.75	0.8568	2.538	75.339	13	6	sandy silt to clayey silt
67.093	37.75	0.8890	2.355	75.601	14	6	sandy silt to clayey silt
67.257	37.17	0.9199	2.475	77.763	14	6	sandy silt to clayey silt
67.421	33.05	0.8069	2.442	79.101	13	6	sandy silt to clayey silt
67.585	31.27	0.6087	1.947	80.697	12	6	sandy silt to clayey silt
67.749	29.62	0.4842	1.635	82.632	11	6	sandy silt to clayey silt
67.913	29.76	0.4777	1.605	85.091	11	6	sandy silt to clayey silt
68.077	28.10	0.4503	1.603	82.629	11	6	sandy silt to clayey silt

Depth ft	Tip (Qt) (tsf)	Sleeve (Fs) (tsf)	FR (Fs/Qt) (%)	PP (U2) (psi)	SPT N60 (UNITLESS)	Zone	Soil Behavior Type UBC-1983
68.241	25.96	0.2421	0.933	83.054	8	7	silty sand to sandy silt
68.406	23.43	0.2293	0.978	83.848	9	6	sandy silt to clayey silt
68.570	21.73	0.2117	0.974	88.553	8	6	sandy silt to clayey silt
68.734	23.10	0.2231	0.966	92.713	9	6	sandy silt to clayey silt
68.898	25.22	0.2162	0.857	97.327	8	7	silty sand to sandy silt
69.062	28.08	0.3695	1.316	98.780	11	6	sandy silt to clayey silt
69.226	27.49	0.4017	1.461	103.043	11	6	sandy silt to clayey silt
69.390	27.84	0.3305	1.187	104.620	11	6	sandy silt to clayey silt
69.554	24.14	0.2885	1.195	106.321	9	6	sandy silt to clayey silt
69.718	23.65	0.2723	1.151	110.333	9	6	sandy silt to clayey silt
69.882	25.01	0.2831	1.132	111.748	10	6	sandy silt to clayey silt
70.046	24.21	0.2521	1.041	108.830	9	6	sandy silt to clayey silt
70.210	21.13	0.2270	1.074	113.203	8	6	sandy silt to clayey silt
70.374	22.30	0.2811	1.261	123.003	9	6	sandy silt to clayey silt
70.538	23.51	0.3483	1.481	123.692	9	6	sandy silt to clayey silt
70.702	24.58	0.3267	1.329	119.661	9	6	sandy silt to clayey silt
70.866	24.27	0.2794	1.151	120.591	9	6	sandy silt to clayey silt
71.030	23.19	0.3539	1.526	123.988	9	6	sandy silt to clayey silt
71.194	30.64	0.6536	2.133	137.161	12	6	sandy silt to clayey silt
71.358	64.43	1.3532	2.100	152.062	21	7	silty sand to sandy silt
71.522	79.46	2.2325	2.810	89.218	30	6	sandy silt to clayey silt
71.686	78.92	2.2674	2.873	99.178	30	6	sandy silt to clayey silt
71.850	85.79	1.3118	1.529	45.240	27	7	silty sand to sandy silt
72.014	59.12	0.5060	0.856	44.524	19	7	silty sand to sandy silt
72.178	52.29	1.6172	3.093	67.722	20	6	sandy silt to clayey silt
72.343	81.25	0.9492	1.168	44.000	19	8	sand to silty sand
72.507	48.12	0.9024	1.875	42.876	15	7	silty sand to sandy silt
72.671	39.33	0.7400	1.881	53.742	15	6	sandy silt to clayey silt
72.835	38.50	0.8458	2.197	54.444	15	6	sandy silt to clayey silt
72.999	35.85	0.8098	2.259	55.520	14	6	sandy silt to clayey silt
73.163	36.51	0.7261	1.989	58.652	14	6	sandy silt to clayey silt
73.327	37.79	0.5689	1.505	59.942	12	7	silty sand to sandy silt
73.491	39.14	0.6522	1.666	62.118	15	6	sandy silt to clayey silt
73.655	37.40	0.8443	2.258	66.181	14	6	sandy silt to clayey silt
73.819	48.50	1.0727	2.212	83.488	19	6	sandy silt to clayey silt
73.983	49.14	1.2560	2.556	84.438	19	6	sandy silt to clayey silt
74.147	47.45	1.3337	2.810	95.223	18	6	sandy silt to clayey silt
74.311	52.69	1.3658	2.592	101.716	20	6	sandy silt to clayey silt
74.475	59.87	1.3947	2.330	107.790	23	6	sandy silt to clayey silt
74.639	63.00	1.3197	2.095	109.706	20	7	silty sand to sandy silt
74.803	56.70	0.8943	1.577	106.817	18	7	silty sand to sandy silt
74.967	49.21	0.8098	1.646	117.595	16	7	silty sand to sandy silt
75.131	40.35	0.7711	1.911	130.639	15	6	sandy silt to clayey silt
75.295	43.42	1.2556	2.892	143.237	17	6	sandy silt to clayey silt
75.459	61.38	1.4495	2.362	160.106	24	6	sandy silt to clayey silt
75.623	54.86	1.6013	2.919	108.324	21	6	sandy silt to clayey silt
75.787	49.82	1.4502	2.911	68.395	19	6	sandy silt to clayey silt
75.951	38.80	1.0677	2.752	73.660	15	6	sandy silt to clayey silt
76.115	32.24	0.8367	2.595	80.327	12	6	sandy silt to clayey silt
76.280	31.09	0.6699	2.154	76.420	12	6	sandy silt to clayey silt
76.444	28.14	0.7213	2.563	75.162	11	6	sandy silt to clayey silt
76.608	27.09	0.7733	2.855	72.670	13	5	clayey silt to silty clay
76.772	26.71	0.7425	2.780	71.625	13	5	clayey silt to silty clay

Depth ft	Tip (Qt) (tsf)	Sleeve (Fs) (tsf)	FR (Fs/Qt) (%)	PP (U2) (psi)	SPT N60 (UNITLESS)	Zone	Soil Behavior Type UBC-1983
76.936	26.90	0.7662	2.849	52.378	13	5	clayey silt to silty clay
77.100	27.62	0.7477	2.708	54.203	13	5	clayey silt to silty clay
77.264	27.30	0.7638	2.797	56.178	13	5	clayey silt to silty clay
77.428	26.59	0.7057	2.654	55.730	13	5	clayey silt to silty clay
77.592	27.17	0.7644	2.813	56.731	13	5	clayey silt to silty clay
77.756	27.59	0.7683	2.785	55.961	13	5	clayey silt to silty clay
77.920	27.47	0.8691	3.164	56.705	13	5	clayey silt to silty clay
78.084	27.73	0.8645	3.117	57.204	13	5	clayey silt to silty clay
78.248	28.11	0.8438	3.002	56.722	13	5	clayey silt to silty clay
78.412	28.76	0.8724	3.033	57.409	14	5	clayey silt to silty clay
78.576	29.38	1.0574	3.599	57.962	14	5	clayey silt to silty clay
78.740	30.74	1.1461	3.728	58.525	15	5	clayey silt to silty clay
78.904	36.38	1.2372	3.400	58.187	17	5	clayey silt to silty clay
79.068	36.46	1.3367	3.667	59.942	17	5	clayey silt to silty clay
79.232	33.42	1.2820	3.836	58.349	16	5	clayey silt to silty clay
79.396	31.03	1.2044	3.882	58.554	20	4	silty clay to clay
79.560	29.58	1.1155	3.771	57.953	14	5	clayey silt to silty clay
79.724	30.18	1.0002	3.314	59.270	14	5	clayey silt to silty clay
79.888	33.13	0.7342	2.216	64.609	13	6	sandy silt to clayey silt
80.052	32.55	0.7993	2.456	62.533	12	6	sandy silt to clayey silt
80.217	32.46	0.8288	2.553	62.004	12	6	sandy silt to clayey silt
80.381	31.24	0.7658	2.451	65.737	12	6	sandy silt to clayey silt
80.545	29.09	0.7439	2.557	68.514	11	6	sandy silt to clayey silt
80.709	28.03	0.6300	2.248	71.274	11	6	sandy silt to clayey silt
80.873	28.36	0.5549	1.957	74.487	11	6	sandy silt to clayey silt
81.037	28.33	0.5359	1.891	75.298	11	6	sandy silt to clayey silt
81.201	26.04	0.4889	1.878	75.298	10	6	sandy silt to clayey silt
81.365	26.45	0.5587	2.113	76.308	10	6	sandy silt to clayey silt
81.529	29.74	0.6031	2.028	82.947	11	6	sandy silt to clayey silt
81.693	28.32	0.4937	1.743	83.350	11	6	sandy silt to clayey silt
81.857	26.28	0.4006	1.524	85.270	10	6	sandy silt to clayey silt
82.021	24.16	0.3984	1.649	89.032	9	6	sandy silt to clayey silt
82.185	27.22	0.4318	1.586	83.376	10	6	sandy silt to clayey silt
82.349	26.04	0.5021	1.928	82.429	10	6	sandy silt to clayey silt
82.513	25.40	0.5312	2.091	77.422	10	6	sandy silt to clayey silt
82.677	22.97	0.4833	2.104	51.090	9	6	sandy silt to clayey silt
82.841	21.68	0.7404	3.415	51.715	10	5	clayey silt to silty clay
83.005	33.13	0.7104	2.144	59.465	13	6	sandy silt to clayey silt
83.169	38.26	0.7002	1.830	65.394	15	6	sandy silt to clayey silt
83.333	42.66	0.6102	1.430	71.994	14	7	silty sand to sandy silt

Shannon & Wilson / CPT-2 / 1400 Wynooski St Newberg

OPERATOR: OGE DMM
 CONE ID: DDG1415
 HOLE NUMBER: CPT-2
 TEST DATE: 5/20/2019 7:45:54 AM
 TOTAL DEPTH: 68.077 ft



- | | | | |
|-----------------------------------------------------------------------------------------------------------------------------------------------------------------------------------------------------------------------------------|-------------------------------------------------------------------------------------------------------------------------------------------------------------------------------------------------------------------------------------------------------------------|------------------------------------------------------------------------------------------------------------------------------------------------------------------------------------------------------------------------------------------------------|--------------------------------------------------------------------------------------------------------------------------------------------------------------------------------------------------------------------------------------------------------------------------|
| <ul style="list-style-type: none"> ■ 1 sensitive fine grained ■ 2 organic material ■ 3 clay | <ul style="list-style-type: none"> ■ 4 silty clay to clay ■ 5 clayey silt to silty clay ■ 6 sandy silt to clayey silt | <ul style="list-style-type: none"> ■ 7 silty sand to sandy silt ■ 8 sand to silty sand ■ 9 sand | <ul style="list-style-type: none"> ■ 10 gravelly sand to sand ■ 11 very stiff fine grained (*) ■ 12 sand to clayey sand (*) |
|-----------------------------------------------------------------------------------------------------------------------------------------------------------------------------------------------------------------------------------|-------------------------------------------------------------------------------------------------------------------------------------------------------------------------------------------------------------------------------------------------------------------|------------------------------------------------------------------------------------------------------------------------------------------------------------------------------------------------------------------------------------------------------|--------------------------------------------------------------------------------------------------------------------------------------------------------------------------------------------------------------------------------------------------------------------------|

*SBT/SPT CORRELATION: UBC-1983

Shannon & Wilson / CPT-2 / 1400 Wynooski St Newberg

OPERATOR: OGE DMM
 CONE ID: DDG1415
 HOLE NUMBER: CPT-2
 TEST DATE: 5/20/2019 7:45:54 AM
 TOTAL DEPTH: 68.077 ft

Depth ft	Tip (Qt) (tsf)	Sleeve (Fs) (tsf)	FR (Fs/Qt) (%)	PP (U2) (psi)	SPT N60 (UNITLESS)	Zone	Soil Behavior Type UBC-1983
0.164	62.94	0.2117	0.336	0.014	15	8	sand to silty sand
0.328	207.74	0.3627	0.175	-0.248	33	10	gravelly sand to sand
0.492	220.35	0.8408	0.382	-0.029	42	9	sand
0.656	231.36	0.8648	0.374	0.329	44	9	sand
0.820	145.86	1.5280	1.048	1.031	35	8	sand to silty sand
0.984	87.35	1.6293	1.865	1.021	28	7	silty sand to sandy silt
1.148	51.36	1.1799	2.297	1.515	20	6	sandy silt to clayey silt
1.312	54.76	1.0444	1.907	1.866	17	7	silty sand to sandy silt
1.476	29.87	0.9160	3.066	1.472	14	5	clayey silt to silty clay
1.640	20.43	0.6653	3.257	1.011	10	5	clayey silt to silty clay
1.804	16.42	0.5084	3.096	0.680	8	5	clayey silt to silty clay
1.969	13.49	0.4385	3.251	0.496	9	4	silty clay to clay
2.133	12.81	0.5471	4.272	0.482	12	3	clay
2.297	13.16	0.6182	4.697	0.413	13	3	clay
2.461	14.52	0.7087	4.882	0.310	14	3	clay
2.625	17.77	0.7615	4.286	0.284	17	3	clay
2.789	20.94	0.7576	3.618	0.355	13	4	silty clay to clay
2.953	21.20	0.7237	3.414	0.370	10	5	clayey silt to silty clay
3.117	20.13	0.7204	3.578	0.475	13	4	silty clay to clay
3.281	20.32	0.7316	3.600	0.542	13	4	silty clay to clay
3.445	21.65	0.7936	3.666	0.553	14	4	silty clay to clay
3.609	21.93	0.7844	3.577	0.613	14	4	silty clay to clay
3.773	20.64	0.6861	3.324	0.661	10	5	clayey silt to silty clay
3.937	19.90	0.5532	2.780	0.840	10	5	clayey silt to silty clay
4.101	19.32	0.4716	2.440	0.947	9	5	clayey silt to silty clay
4.265	19.83	0.4765	2.403	1.159	9	5	clayey silt to silty clay
4.429	20.93	0.4308	2.058	1.345	8	6	sandy silt to clayey silt
4.593	20.36	0.4053	1.990	1.472	8	6	sandy silt to clayey silt
4.757	19.74	0.3924	1.988	2.455	8	6	sandy silt to clayey silt
4.921	19.07	0.3857	2.023	2.774	9	5	clayey silt to silty clay
5.085	19.00	0.3532	1.859	3.085	7	6	sandy silt to clayey silt
5.249	18.38	0.3134	1.705	3.333	7	6	sandy silt to clayey silt
5.413	18.07	0.2856	1.580	3.540	7	6	sandy silt to clayey silt
5.577	17.85	0.2851	1.597	3.750	7	6	sandy silt to clayey silt
5.741	18.04	0.2705	1.499	4.022	7	6	sandy silt to clayey silt
5.906	18.48	0.2819	1.525	4.394	7	6	sandy silt to clayey silt
6.070	19.14	0.2979	1.557	4.769	7	6	sandy silt to clayey silt
6.234	19.91	0.3333	1.674	5.072	8	6	sandy silt to clayey silt
6.398	21.24	0.4116	1.938	5.387	8	6	sandy silt to clayey silt
6.562	21.56	0.4805	2.229	5.651	10	5	clayey silt to silty clay
6.726	21.75	0.4860	2.235	5.950	10	5	clayey silt to silty clay
6.890	21.49	0.4778	2.223	6.088	10	5	clayey silt to silty clay
7.054	21.30	0.4557	2.139	6.286	8	6	sandy silt to clayey silt
7.218	21.65	0.4116	1.901	6.599	8	6	sandy silt to clayey silt

Depth ft	Tip (Qt) (tsf)	Sleeve (Fs) (tsf)	FR (Fs/Qt) (%)	PP (U2) (psi)	SPT N60 (UNITLESS)	Zone	Soil Behavior Type UBC-1983
7.382	20.52	0.4121	2.008	6.737	8	6	sandy silt to clayey silt
7.546	22.85	0.5029	2.201	6.959	9	6	sandy silt to clayey silt
7.710	27.86	0.7335	2.633	7.126	13	5	clayey silt to silty clay
7.874	27.68	0.4992	1.803	6.882	11	6	sandy silt to clayey silt
8.038	16.07	0.2661	1.655	6.651	8	5	clayey silt to silty clay
8.202	16.15	0.2694	1.668	7.340	8	5	clayey silt to silty clay
8.366	17.82	0.2242	1.258	7.794	7	6	sandy silt to clayey silt
8.530	14.72	0.1796	1.220	7.741	6	6	sandy silt to clayey silt
8.694	13.77	0.1368	0.993	8.199	5	6	sandy silt to clayey silt
8.858	15.24	0.2524	1.657	8.590	7	5	clayey silt to silty clay
9.022	22.90	0.4549	1.986	8.965	9	6	sandy silt to clayey silt
9.186	21.69	0.4480	2.066	8.171	8	6	sandy silt to clayey silt
9.350	18.40	0.2562	1.393	8.087	7	6	sandy silt to clayey silt
9.514	14.47	0.1451	1.003	8.381	6	6	sandy silt to clayey silt
9.678	13.00	0.1061	0.816	8.810	5	6	sandy silt to clayey silt
9.843	13.48	0.1353	1.004	9.483	5	6	sandy silt to clayey silt
10.007	17.04	0.2337	1.371	10.222	7	6	sandy silt to clayey silt
10.171	17.19	0.2515	1.463	9.998	7	6	sandy silt to clayey silt
10.335	15.27	0.1644	1.077	10.022	6	6	sandy silt to clayey silt
10.499	12.67	0.1082	0.854	10.217	5	6	sandy silt to clayey silt
10.663	11.91	0.0583	0.489	10.623	5	6	sandy silt to clayey silt
10.827	11.85	0.0541	0.457	11.131	5	6	sandy silt to clayey silt
10.991	12.51	0.1058	0.846	11.880	5	6	sandy silt to clayey silt
11.155	14.72	0.1589	1.079	12.596	6	6	sandy silt to clayey silt
11.319	17.12	0.2189	1.278	14.211	7	6	sandy silt to clayey silt
11.483	19.13	0.2065	1.079	14.707	7	6	sandy silt to clayey silt
11.647	16.80	0.1254	0.747	14.931	6	6	sandy silt to clayey silt
11.811	13.41	0.0759	0.566	15.475	5	6	sandy silt to clayey silt
11.975	14.13	0.0827	0.585	16.155	5	6	sandy silt to clayey silt
12.139	13.43	0.0698	0.520	16.816	5	6	sandy silt to clayey silt
12.303	12.36	0.0760	0.615	17.541	5	6	sandy silt to clayey silt
12.467	14.49	0.0858	0.592	18.223	6	6	sandy silt to clayey silt
12.631	16.00	0.1774	1.109	19.101	6	6	sandy silt to clayey silt
12.795	20.63	0.2637	1.278	19.741	8	6	sandy silt to clayey silt
12.959	19.96	0.3330	1.668	19.891	8	6	sandy silt to clayey silt
13.123	24.58	0.4110	1.672	20.046	9	6	sandy silt to clayey silt
13.287	31.76	0.5274	1.660	15.003	12	6	sandy silt to clayey silt
13.451	25.60	0.4893	1.911	10.134	10	6	sandy silt to clayey silt
13.615	19.69	0.4989	2.534	9.328	9	5	clayey silt to silty clay
13.780	24.18	0.4108	1.699	9.654	9	6	sandy silt to clayey silt
13.944	17.91	0.2623	1.464	9.177	7	6	sandy silt to clayey silt
14.108	17.20	0.3924	2.281	9.688	8	5	clayey silt to silty clay
14.272	31.47	0.9786	3.109	10.893	15	5	clayey silt to silty clay
14.436	39.44	0.9471	2.401	11.024	15	6	sandy silt to clayey silt
14.600	31.75	0.8078	2.544	7.801	12	6	sandy silt to clayey silt
14.764	31.12	0.8036	2.582	7.431	12	6	sandy silt to clayey silt
14.928	27.94	0.7848	2.808	6.517	13	5	clayey silt to silty clay
15.092	27.00	0.7488	2.774	6.310	13	5	clayey silt to silty clay
15.256	23.62	0.5596	2.369	5.864	11	5	clayey silt to silty clay
15.420	19.17	0.3332	1.738	5.628	7	6	sandy silt to clayey silt
15.584	13.57	0.2046	1.507	5.804	6	5	clayey silt to silty clay
15.748	14.01	0.1997	1.426	6.355	7	5	clayey silt to silty clay
15.912	14.97	0.2900	1.936	6.706	7	5	clayey silt to silty clay

Depth ft	Tip (Qt) (tsf)	Sleeve (Fs) (tsf)	FR (Fs/Qt) (%)	PP (U2) (psi)	SPT N60 (UNITLESS)	Zone	Soil Behavior Type UBC-1983
16.076	24.35	0.5088	2.090	7.059	9	6	sandy silt to clayey silt
16.240	26.61	0.6479	2.435	6.775	10	6	sandy silt to clayey silt
16.404	30.58	0.7787	2.547	7.107	12	6	sandy silt to clayey silt
16.568	34.87	0.9498	2.724	7.078	13	6	sandy silt to clayey silt
16.732	31.74	0.8913	2.808	6.882	12	6	sandy silt to clayey silt
16.896	22.96	0.7003	3.050	6.854	11	5	clayey silt to silty clay
17.060	22.38	0.4684	2.093	7.283	9	6	sandy silt to clayey silt
17.224	16.78	0.4557	2.716	7.343	8	5	clayey silt to silty clay
17.388	16.73	0.5611	3.355	7.677	11	4	silty clay to clay
17.552	36.87	1.5895	4.310	8.159	24	4	silty clay to clay
17.717	59.16	1.6428	2.777	8.490	23	6	sandy silt to clayey silt
17.881	57.26	2.1018	3.671	5.713	27	5	clayey silt to silty clay
18.045	56.05	1.6295	2.907	5.749	21	6	sandy silt to clayey silt
18.209	39.02	1.1964	3.066	5.351	19	5	clayey silt to silty clay
18.373	22.81	0.7812	3.425	5.153	11	5	clayey silt to silty clay
18.537	19.19	0.6423	3.347	5.475	9	5	clayey silt to silty clay
18.701	26.28	0.8534	3.247	6.143	13	5	clayey silt to silty clay
18.865	34.44	1.0382	3.014	6.329	16	5	clayey silt to silty clay
19.029	38.25	1.1612	3.036	6.463	18	5	clayey silt to silty clay
19.193	36.10	1.2423	3.441	6.687	17	5	clayey silt to silty clay
19.357	37.04	1.2955	3.497	6.677	18	5	clayey silt to silty clay
19.521	32.53	1.1270	3.465	6.505	16	5	clayey silt to silty clay
19.685	21.01	0.6927	3.297	6.036	10	5	clayey silt to silty clay
19.849	14.94	0.3303	2.211	6.050	7	5	clayey silt to silty clay
20.013	11.92	0.2041	1.711	6.067	6	5	clayey silt to silty clay
20.177	13.86	0.3224	2.327	6.219	7	5	clayey silt to silty clay
20.341	25.05	0.5649	2.255	6.346	10	6	sandy silt to clayey silt
20.505	37.09	0.8931	2.408	6.126	14	6	sandy silt to clayey silt
20.669	47.14	1.0614	2.252	5.754	18	6	sandy silt to clayey silt
20.833	36.81	0.5619	1.526	4.318	14	6	sandy silt to clayey silt
20.997	26.05	0.4860	1.866	3.717	10	6	sandy silt to clayey silt
21.161	12.18	0.2529	2.076	3.237	6	5	clayey silt to silty clay
21.325	10.69	0.1002	0.937	3.597	5	5	clayey silt to silty clay
21.490	12.17	0.0948	0.779	3.970	5	6	sandy silt to clayey silt
21.654	16.88	0.3339	1.977	4.814	8	5	clayey silt to silty clay
21.818	23.64	0.6882	2.911	5.442	11	5	clayey silt to silty clay
21.982	33.02	0.9393	2.845	5.606	13	6	sandy silt to clayey silt
22.146	58.21	1.2928	2.221	5.205	22	6	sandy silt to clayey silt
22.310	69.96	1.5876	2.269	4.055	27	6	sandy silt to clayey silt
22.474	61.54	1.9306	3.137	2.603	24	6	sandy silt to clayey silt
22.638	59.97	1.7852	2.977	2.522	23	6	sandy silt to clayey silt
22.802	62.42	1.8879	3.025	2.426	24	6	sandy silt to clayey silt
22.966	61.33	1.7348	2.829	2.018	23	6	sandy silt to clayey silt
23.130	53.21	1.6713	3.141	1.997	20	6	sandy silt to clayey silt
23.294	41.36	1.3125	3.173	1.710	20	5	clayey silt to silty clay
23.458	27.10	1.0576	3.903	1.212	17	4	silty clay to clay
23.622	25.48	0.8380	3.290	1.126	12	5	clayey silt to silty clay
23.786	18.52	0.5359	2.894	0.973	9	5	clayey silt to silty clay
23.950	12.49	0.2729	2.185	1.064	6	5	clayey silt to silty clay
24.114	16.28	0.1831	1.124	1.353	6	6	sandy silt to clayey silt
24.278	14.93	0.3954	2.649	1.398	7	5	clayey silt to silty clay
24.442	30.56	1.0814	3.539	2.557	15	5	clayey silt to silty clay
24.606	51.65	1.5488	2.999	2.887	20	6	sandy silt to clayey silt

Depth ft	Tip (Qt) (tsf)	Sleeve (Fs) (tsf)	FR (Fs/Qt) (%)	PP (U2) (psi)	SPT N60 (UNITLESS)	Zone	Soil Behavior Type UBC-1983
24.770	49.08	1.6649	3.392	3.309	24	5	clayey silt to silty clay
24.934	43.00	1.4064	3.271	3.822	21	5	clayey silt to silty clay
25.098	37.27	1.4063	3.773	4.072	18	5	clayey silt to silty clay
25.262	39.42	1.5817	4.012	4.299	19	5	clayey silt to silty clay
25.427	47.25	1.5639	3.310	3.650	23	5	clayey silt to silty clay
25.591	47.11	1.4160	3.006	2.355	18	6	sandy silt to clayey silt
25.755	39.18	1.1565	2.952	1.436	15	6	sandy silt to clayey silt
25.919	35.21	1.0746	3.051	0.697	17	5	clayey silt to silty clay
26.083	32.78	0.9296	2.835	-2.219	13	6	sandy silt to clayey silt
26.247	26.70	1.0170	3.809	-2.856	17	4	silty clay to clay
26.411	33.22	1.0886	3.276	-2.679	16	5	clayey silt to silty clay
26.575	37.42	1.1342	3.031	-2.588	18	5	clayey silt to silty clay
26.739	39.68	1.2471	3.143	-2.512	19	5	clayey silt to silty clay
26.903	34.15	1.0349	3.031	-2.407	16	5	clayey silt to silty clay
27.067	24.29	0.8021	3.302	-2.514	12	5	clayey silt to silty clay
27.231	22.38	0.5844	2.611	-2.483	11	5	clayey silt to silty clay
27.395	19.21	0.2783	1.449	-2.400	7	6	sandy silt to clayey silt
27.559	14.78	0.3063	2.072	-2.350	7	5	clayey silt to silty clay
27.723	16.41	0.3911	2.383	-1.947	8	5	clayey silt to silty clay
27.887	16.47	0.3381	2.053	-1.811	8	5	clayey silt to silty clay
28.051	15.14	0.3297	2.177	-1.610	7	5	clayey silt to silty clay
28.215	15.73	0.2398	1.525	-1.310	6	6	sandy silt to clayey silt
28.379	13.36	0.2450	1.834	-1.102	6	5	clayey silt to silty clay
28.543	12.23	0.1723	1.409	-0.825	6	5	clayey silt to silty clay
28.707	12.85	0.1571	1.222	-0.735	5	6	sandy silt to clayey silt
28.871	15.49	0.5428	3.505	-0.542	10	4	silty clay to clay
29.035	31.17	0.9619	3.086	-0.024	15	5	clayey silt to silty clay
29.199	39.29	1.0580	2.693	-0.754	15	6	sandy silt to clayey silt
29.364	41.68	0.8405	2.016	-1.429	16	6	sandy silt to clayey silt
29.528	18.21	0.7370	4.047	-2.555	12	4	silty clay to clay
29.692	14.74	0.6291	4.269	-2.056	14	3	clay
29.856	21.47	0.6302	2.935	-1.429	10	5	clayey silt to silty clay
30.020	26.87	0.7024	2.614	-1.298	13	5	clayey silt to silty clay
30.184	24.10	0.6654	2.761	-0.933	12	5	clayey silt to silty clay
30.348	21.54	0.3429	1.591	-0.969	8	6	sandy silt to clayey silt
30.512	16.62	0.2593	1.560	-0.816	6	6	sandy silt to clayey silt
30.676	15.58	0.5606	3.597	-0.670	10	4	silty clay to clay
30.840	38.40	0.5080	1.323	-0.389	12	7	silty sand to sandy silt
31.004	19.87	0.3514	1.768	-1.004	8	6	sandy silt to clayey silt
31.168	13.87	0.1656	1.194	-0.964	5	6	sandy silt to clayey silt
31.332	12.66	0.2345	1.852	-0.778	6	5	clayey silt to silty clay
31.496	15.40	0.3281	2.130	-0.499	7	5	clayey silt to silty clay
31.660	22.37	0.3540	1.582	-0.432	9	6	sandy silt to clayey silt
31.824	23.12	0.4856	2.100	-0.675	9	6	sandy silt to clayey silt
31.988	17.85	0.4148	2.323	-0.756	9	5	clayey silt to silty clay
32.152	16.13	0.2985	1.851	-0.518	8	5	clayey silt to silty clay
32.316	26.10	0.4669	1.789	-0.615	10	6	sandy silt to clayey silt
32.480	27.32	0.5922	2.167	-0.563	10	6	sandy silt to clayey silt
32.644	17.75	0.4262	2.401	-0.615	9	5	clayey silt to silty clay
32.808	11.85	0.3140	2.650	-0.429	8	4	silty clay to clay
32.972	12.03	0.3757	3.124	0.346	8	4	silty clay to clay
33.136	26.74	0.7134	2.668	1.007	13	5	clayey silt to silty clay
33.301	40.19	0.7977	1.985	0.608	15	6	sandy silt to clayey silt

Depth ft	Tip (Qt) (tsf)	Sleeve (Fs) (tsf)	FR (Fs/Qt) (%)	PP (U2) (psi)	SPT N60 (UNITLESS)	Zone	Soil Behavior Type UBC-1983
33.465	55.72	0.8002	1.436	-0.239	18	7	silty sand to sandy silt
33.629	69.87	0.9174	1.313	-1.229	22	7	silty sand to sandy silt
33.793	73.78	1.1441	1.551	-1.481	24	7	silty sand to sandy silt
33.957	72.30	1.1919	1.649	-1.594	23	7	silty sand to sandy silt
34.121	67.30	1.1344	1.686	-1.658	21	7	silty sand to sandy silt
34.285	57.30	1.2234	2.135	-1.508	22	6	sandy silt to clayey silt
34.449	48.26	1.3049	2.704	-1.345	18	6	sandy silt to clayey silt
34.613	32.22	1.3293	4.126	-1.291	21	4	silty clay to clay
34.777	24.83	0.9484	3.820	-1.083	16	4	silty clay to clay
34.941	42.95	1.0137	2.360	-0.499	16	6	sandy silt to clayey silt
35.105	55.80	1.4088	2.525	-0.840	21	6	sandy silt to clayey silt
35.269	58.66	1.4897	2.540	-1.355	22	6	sandy silt to clayey silt
35.433	46.94	1.1250	2.397	-1.543	18	6	sandy silt to clayey silt
35.597	26.95	0.8109	3.009	-1.811	13	5	clayey silt to silty clay
35.761	14.46	0.3781	2.615	-2.030	7	5	clayey silt to silty clay
35.925	14.41	0.2454	1.703	-1.722	7	5	clayey silt to silty clay
36.089	14.08	0.4104	2.915	-1.241	7	5	clayey silt to silty clay
36.253	18.07	0.7063	3.909	-0.592	12	4	silty clay to clay
36.417	29.33	1.2077	4.118	-0.036	19	4	silty clay to clay
36.581	34.54	1.1805	3.418	-0.129	17	5	clayey silt to silty clay
36.745	48.76	1.0733	2.201	-0.363	19	6	sandy silt to clayey silt
36.909	58.52	0.7415	1.267	-1.143	19	7	silty sand to sandy silt
37.073	62.61	0.8821	1.409	-1.970	20	7	silty sand to sandy silt
37.238	63.10	1.2851	2.037	-2.176	20	7	silty sand to sandy silt
37.402	60.12	1.3359	2.222	-2.183	23	6	sandy silt to clayey silt
37.566	51.89	1.3458	2.594	-1.942	20	6	sandy silt to clayey silt
37.730	42.25	1.3583	3.215	-1.925	20	5	clayey silt to silty clay
37.894	31.09	1.1687	3.759	-1.727	15	5	clayey silt to silty clay
38.058	17.24	0.6329	3.671	-1.481	11	4	silty clay to clay
38.222	13.15	0.5965	4.535	-0.208	13	3	clay
38.386	20.99	1.4438	6.879	6.203	20	3	clay
38.550	59.11	2.4877	4.209	13.443	28	5	clayey silt to silty clay
38.714	57.27	3.2200	5.622	8.676	55	3	clay
38.878	63.74	3.3161	5.203	8.879	61	11	very stiff fine grained (*)
39.042	58.83	2.9721	5.052	5.332	38	4	silty clay to clay
39.206	64.41	2.4638	3.825	3.395	31	5	clayey silt to silty clay
39.370	67.76	2.0729	3.059	-0.448	26	6	sandy silt to clayey silt
39.534	74.07	1.2450	1.681	-5.859	24	7	silty sand to sandy silt
39.698	83.32	1.2075	1.449	-7.324	27	7	silty sand to sandy silt
39.862	90.38	1.3784	1.525	-7.286	29	7	silty sand to sandy silt
40.026	89.85	1.6360	1.821	-7.286	29	7	silty sand to sandy silt
40.190	88.67	1.8123	2.044	-7.092	28	7	silty sand to sandy silt
40.354	85.42	1.7939	2.100	-6.954	27	7	silty sand to sandy silt
40.518	81.86	1.8000	2.199	-6.770	26	7	silty sand to sandy silt
40.682	77.30	1.9106	2.472	-6.389	30	6	sandy silt to clayey silt
40.846	44.11	1.7919	4.062	-6.088	21	5	clayey silt to silty clay
41.011	28.17	1.6981	6.029	-5.687	27	3	clay
41.175	24.79	1.9524	7.875	-1.491	24	3	clay
41.339	78.77	3.2032	4.067	3.316	38	5	clayey silt to silty clay
41.503	105.42	4.9791	4.723	2.495	101	11	very stiff fine grained (*)
41.667	113.31	5.5155	4.868	0.396	109	11	very stiff fine grained (*)
41.831	89.34	5.0338	5.634	-0.685	86	11	very stiff fine grained (*)
41.995	93.38	3.6769	3.937	-0.897	45	5	clayey silt to silty clay

Depth ft	Tip (Qt) (tsf)	Sleeve (Fs) (tsf)	FR (Fs/Qt) (%)	PP (U2) (psi)	SPT N60 (UNITLESS)	Zone	Soil Behavior Type UBC-1983
42.159	87.50	2.1952	2.509	-1.932	34	6	sandy silt to clayey silt
42.323	58.24	1.8486	3.174	-2.920	22	6	sandy silt to clayey silt
42.487	35.98	2.0145	5.599	-3.159	34	3	clay
42.651	92.29	2.3604	2.558	-2.603	35	6	sandy silt to clayey silt
42.815	153.20	2.4998	1.632	-2.698	37	8	sand to silty sand
42.979	160.44	2.3360	1.456	-3.624	38	8	sand to silty sand
43.143	140.78	2.2298	1.584	-3.979	34	8	sand to silty sand
43.307	97.58	2.3884	2.448	-4.342	31	7	silty sand to sandy silt
43.471	57.50	2.5248	4.391	-4.270	37	4	silty clay to clay
43.635	40.57	2.0766	5.119	-4.020	39	3	clay
43.799	52.90	3.0128	5.695	-3.213	51	3	clay
43.963	71.07	3.4163	4.807	-2.550	68	11	very stiff fine grained (*)
44.127	79.17	2.9161	3.683	-2.531	38	5	clayey silt to silty clay
44.291	61.72	1.8044	2.924	-3.244	24	6	sandy silt to clayey silt
44.455	29.86	1.0312	3.453	-4.039	14	5	clayey silt to silty clay
44.619	19.27	0.2954	1.533	-4.571	7	6	sandy silt to clayey silt
44.783	12.70	0.4616	3.634	-3.993	8	4	silty clay to clay
44.948	23.01	0.8302	3.608	-3.068	15	4	silty clay to clay
45.112	42.55	1.4290	3.358	-2.677	20	5	clayey silt to silty clay
45.276	49.86	1.5868	3.183	-3.113	24	5	clayey silt to silty clay
45.440	48.55	1.9701	4.058	-3.445	23	5	clayey silt to silty clay
45.604	49.96	2.0537	4.110	-3.213	24	5	clayey silt to silty clay
45.768	53.59	1.8214	3.399	-3.199	26	5	clayey silt to silty clay
45.932	56.74	1.1899	2.097	-3.359	22	6	sandy silt to clayey silt
46.096	59.41	0.6959	1.171	-4.327	19	7	silty sand to sandy silt
46.260	60.47	0.6512	1.077	-4.714	19	7	silty sand to sandy silt
46.424	57.90	0.8463	1.462	-4.671	18	7	silty sand to sandy silt
46.588	44.78	1.1633	2.598	-4.628	17	6	sandy silt to clayey silt
46.752	27.49	1.0975	3.993	-4.256	18	4	silty clay to clay
46.916	17.75	0.5651	3.183	-3.803	8	5	clayey silt to silty clay
47.080	15.45	0.1181	0.764	-1.639	6	6	sandy silt to clayey silt
47.244	16.96	0.4103	2.420	-0.654	8	5	clayey silt to silty clay
47.408	26.59	1.0806	4.064	3.123	17	4	silty clay to clay
47.572	51.03	1.9474	3.816	4.394	24	5	clayey silt to silty clay
47.736	52.71	2.3855	4.526	5.198	34	4	silty clay to clay
47.900	53.55	1.9617	3.663	4.473	26	5	clayey silt to silty clay
48.064	51.31	1.5884	3.096	-0.146	20	6	sandy silt to clayey silt
48.228	44.58	1.2232	2.744	-2.080	17	6	sandy silt to clayey silt
48.392	35.65	0.7900	2.216	-2.536	14	6	sandy silt to clayey silt
48.556	27.26	0.4202	1.541	-2.142	10	6	sandy silt to clayey silt
48.720	21.69	0.3138	1.447	-1.539	8	6	sandy silt to clayey silt
48.885	16.81	0.4609	2.743	-0.258	8	5	clayey silt to silty clay
49.049	22.06	0.7511	3.404	1.684	11	5	clayey silt to silty clay
49.213	25.52	0.8178	3.205	3.397	12	5	clayey silt to silty clay
49.377	21.05	0.8227	3.908	3.545	13	4	silty clay to clay
49.541	22.02	0.7556	3.432	4.392	11	5	clayey silt to silty clay
49.705	18.78	0.4607	2.453	4.843	9	5	clayey silt to silty clay
49.869	17.62	0.4247	2.410	5.255	8	5	clayey silt to silty clay
50.033	23.46	0.8705	3.711	8.051	15	4	silty clay to clay
50.197	39.12	1.2815	3.275	8.245	19	5	clayey silt to silty clay
50.361	42.15	1.1446	2.716	6.727	16	6	sandy silt to clayey silt
50.525	41.67	0.9145	2.194	2.197	16	6	sandy silt to clayey silt
50.689	17.06	0.6402	3.752	3.481	11	4	silty clay to clay

Depth ft	Tip (Qt) (tsf)	Sleeve (Fs) (tsf)	FR (Fs/Qt) (%)	PP (U2) (psi)	SPT N60 (UNITLESS)	Zone	Soil Behavior Type UBC-1983
50.853	22.18	0.4588	2.069	5.255	8	6	sandy silt to clayey silt
51.017	17.25	0.3303	1.915	5.833	8	5	clayey silt to silty clay
51.181	15.96	0.2333	1.462	7.558	6	6	sandy silt to clayey silt
51.345	13.78	0.2298	1.668	9.523	7	5	clayey silt to silty clay
51.509	17.88	0.1818	1.017	11.699	7	6	sandy silt to clayey silt
51.673	15.32	0.2272	1.483	14.490	6	6	sandy silt to clayey silt
51.837	18.92	0.2465	1.303	17.040	7	6	sandy silt to clayey silt
52.001	18.19	0.2900	1.594	18.233	7	6	sandy silt to clayey silt
52.165	15.09	0.2996	1.985	22.424	7	5	clayey silt to silty clay
52.329	14.54	0.2574	1.770	28.844	7	5	clayey silt to silty clay
52.493	20.00	0.4255	2.127	34.892	10	5	clayey silt to silty clay
52.657	31.16	1.0568	3.392	43.797	15	5	clayey silt to silty clay
52.822	44.04	1.5819	3.592	50.527	21	5	clayey silt to silty clay
52.986	45.25	1.8241	4.031	39.667	22	5	clayey silt to silty clay
53.150	36.51	1.3890	3.805	28.357	17	5	clayey silt to silty clay
53.314	25.80	1.0815	4.191	22.205	16	4	silty clay to clay
53.478	22.82	0.7928	3.475	32.721	11	5	clayey silt to silty clay
53.642	32.53	1.1113	3.416	44.474	16	5	clayey silt to silty clay
53.806	38.35	1.1646	3.037	43.542	18	5	clayey silt to silty clay
53.970	31.35	1.2541	4.000	20.304	20	4	silty clay to clay
54.134	45.17	1.7139	3.795	20.132	22	5	clayey silt to silty clay
54.298	36.31	1.3244	3.648	8.633	17	5	clayey silt to silty clay
54.462	24.43	0.8072	3.305	7.980	12	5	clayey silt to silty clay
54.626	20.36	0.6445	3.166	11.825	10	5	clayey silt to silty clay
54.790	24.83	0.5956	2.399	15.103	10	6	sandy silt to clayey silt
54.954	22.14	0.6474	2.924	15.762	11	5	clayey silt to silty clay
55.118	22.97	0.4324	1.882	18.848	9	6	sandy silt to clayey silt
55.282	18.41	0.4474	2.430	20.590	9	5	clayey silt to silty clay
55.446	20.93	0.4243	2.027	28.002	8	6	sandy silt to clayey silt
55.610	21.30	0.5372	2.522	30.850	10	5	clayey silt to silty clay
55.774	20.95	0.4946	2.361	30.674	10	5	clayey silt to silty clay
55.938	23.98	0.4818	2.009	39.348	9	6	sandy silt to clayey silt
56.102	26.86	0.4152	1.546	36.976	10	6	sandy silt to clayey silt
56.266	21.00	0.3547	1.689	38.811	8	6	sandy silt to clayey silt
56.430	17.77	0.1508	0.848	46.734	7	6	sandy silt to clayey silt
56.594	14.89	0.1039	0.698	50.772	6	6	sandy silt to clayey silt
56.759	17.39	0.2993	1.721	69.418	7	6	sandy silt to clayey silt
56.923	31.53	1.1767	3.732	81.103	15	5	clayey silt to silty clay
57.087	41.23	1.1449	2.777	73.862	16	6	sandy silt to clayey silt
57.251	38.75	0.9680	2.498	89.757	15	6	sandy silt to clayey silt
57.415	38.70	0.9807	2.534	95.478	15	6	sandy silt to clayey silt
57.579	41.23	1.1432	2.773	116.364	16	6	sandy silt to clayey silt
57.743	49.54	1.4528	2.932	93.789	19	6	sandy silt to clayey silt
57.907	47.72	1.8471	3.871	66.283	23	5	clayey silt to silty clay
58.071	42.13	1.9317	4.585	54.024	27	4	silty clay to clay
58.235	38.13	1.9902	5.220	45.185	37	3	clay
58.399	36.42	2.0816	5.716	45.574	35	3	clay
58.563	37.27	2.0405	5.475	39.505	36	3	clay
58.727	36.38	1.9695	5.414	38.060	35	3	clay
58.891	36.74	1.8407	5.011	45.157	35	3	clay
59.055	37.13	1.7896	4.820	44.343	36	3	clay
59.219	34.94	1.8002	5.153	43.919	33	3	clay
59.383	32.51	1.5375	4.730	44.474	31	3	clay

Depth ft	Tip (Qt) (tsf)	Sleeve (Fs) (tsf)	FR (Fs/Qt) (%)	PP (U2) (psi)	SPT N60 (UNITLESS)	Zone	Soil Behavior Type UBC-1983
59.547	31.86	1.5373	4.825	44.377	31	3	clay
59.711	32.03	1.5654	4.887	42.800	31	3	clay
59.875	30.88	1.4569	4.717	41.531	30	3	clay
60.039	31.57	1.4089	4.462	42.840	20	4	silty clay to clay
60.203	32.41	1.2831	3.958	44.021	21	4	silty clay to clay
60.367	34.42	1.3197	3.834	43.737	16	5	clayey silt to silty clay
60.532	33.65	1.3438	3.994	54.332	21	4	silty clay to clay
60.696	35.37	1.3642	3.856	54.651	17	5	clayey silt to silty clay
60.860	33.90	1.3197	3.893	58.740	16	5	clayey silt to silty clay
61.024	33.23	1.3337	4.014	61.875	21	4	silty clay to clay
61.188	35.98	1.3336	3.707	61.581	17	5	clayey silt to silty clay
61.352	34.31	1.3790	4.020	62.607	22	4	silty clay to clay
61.516	34.52	1.3187	3.820	64.141	17	5	clayey silt to silty clay
61.680	34.30	1.3584	3.960	60.830	22	4	silty clay to clay
61.844	34.64	1.5718	4.538	48.434	22	4	silty clay to clay
62.008	35.15	1.5636	4.449	39.279	22	4	silty clay to clay
62.172	31.62	1.3043	4.125	42.122	20	4	silty clay to clay
62.336	30.82	1.1413	3.704	44.656	15	5	clayey silt to silty clay
62.500	31.06	1.2667	4.079	47.771	20	4	silty clay to clay
62.664	30.45	1.2851	4.220	50.524	19	4	silty clay to clay
62.828	32.01	1.3000	4.062	53.902	20	4	silty clay to clay
62.992	34.17	1.3534	3.961	56.927	22	4	silty clay to clay
63.156	35.85	1.4993	4.182	62.576	23	4	silty clay to clay
63.320	34.85	1.5813	4.537	65.625	22	4	silty clay to clay
63.484	36.99	1.4635	3.956	64.470	18	5	clayey silt to silty clay
63.648	34.83	1.3150	3.776	64.921	17	5	clayey silt to silty clay
63.812	35.88	1.2788	3.565	68.232	17	5	clayey silt to silty clay
63.976	36.02	1.3100	3.636	62.288	17	5	clayey silt to silty clay
64.140	36.57	1.3685	3.742	66.441	18	5	clayey silt to silty clay
64.304	35.69	1.4965	4.193	66.765	23	4	silty clay to clay
64.469	35.84	1.4792	4.127	62.452	23	4	silty clay to clay
64.633	37.04	1.5192	4.102	59.771	24	4	silty clay to clay
64.797	37.21	1.4105	3.791	60.563	18	5	clayey silt to silty clay
64.961	37.69	1.5462	4.103	64.277	24	4	silty clay to clay
65.125	42.07	1.7310	4.115	63.633	20	5	clayey silt to silty clay
65.289	44.24	1.8263	4.128	54.508	21	5	clayey silt to silty clay
65.453	45.84	1.8815	4.104	52.674	22	5	clayey silt to silty clay
65.617	46.29	1.9723	4.261	54.310	30	4	silty clay to clay
65.781	44.98	1.9784	4.399	64.866	29	4	silty clay to clay
65.945	46.04	1.9568	4.251	71.047	29	4	silty clay to clay
66.109	49.77	2.1048	4.229	79.912	24	5	clayey silt to silty clay
66.273	55.05	2.4558	4.461	81.813	35	4	silty clay to clay
66.437	58.50	2.7750	4.744	84.719	37	4	silty clay to clay
66.601	62.41	2.7191	4.357	106.631	30	5	clayey silt to silty clay
66.765	58.47	2.0453	3.498	114.861	28	5	clayey silt to silty clay
66.929	50.00	1.8587	3.718	90.161	24	5	clayey silt to silty clay
67.093	38.51	1.5425	4.006	65.401	18	5	clayey silt to silty clay
67.257	37.38	1.3676	3.659	74.392	18	5	clayey silt to silty clay
67.421	37.17	1.2422	3.342	78.311	18	5	clayey silt to silty clay
67.585	41.14	1.2265	2.981	84.784	16	6	sandy silt to clayey silt
67.749	43.23	1.2056	2.789	87.288	17	6	sandy silt to clayey silt
67.913	41.93	1.2003	2.863	81.131	16	6	sandy silt to clayey silt
68.077	40.50	1.2603	3.112	82.193	19	5	clayey silt to silty clay

Appendix B

Slope Stability Summary Results

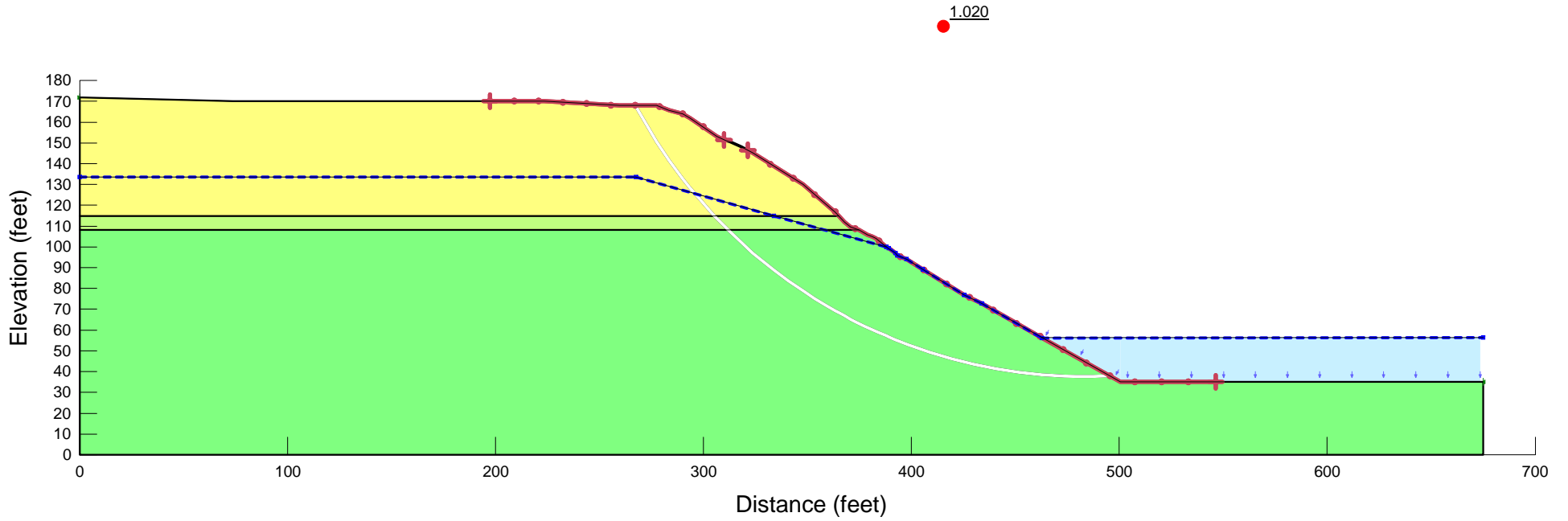
Figures

Figure B-1: Static Slope Stability

Figure B-2: Seismic Slope Stability

Figure B-3: Post-Seismic Slope Stability

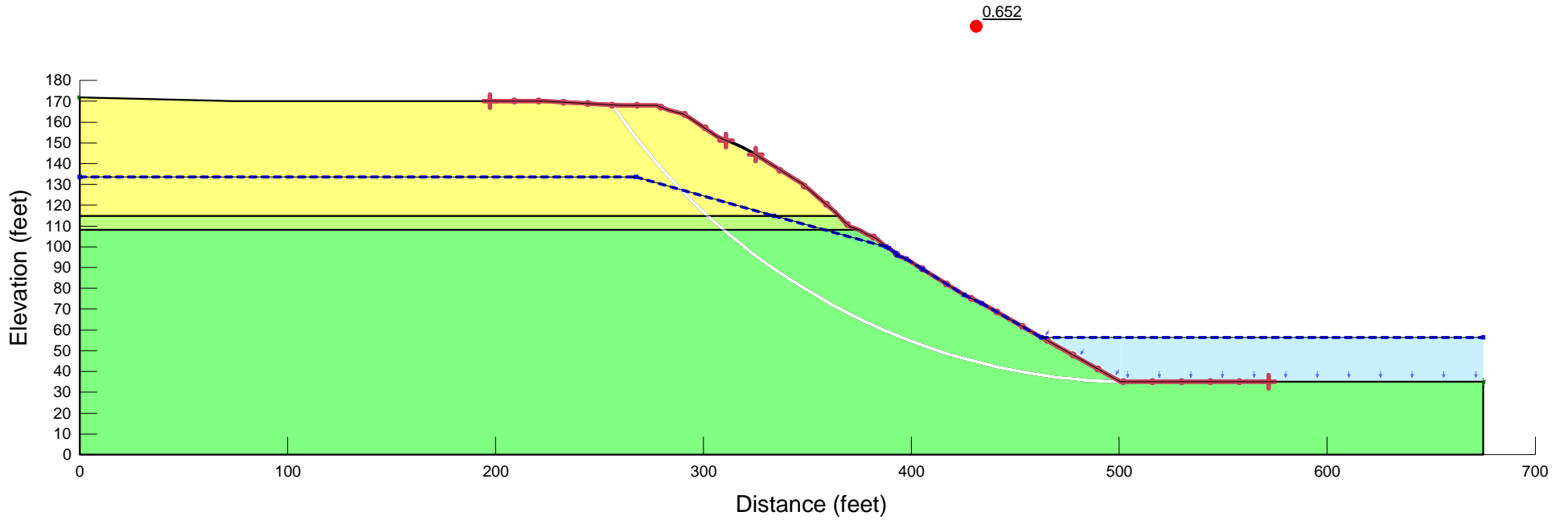
101895 - City of Newberg Water System Resilience
 Figure B-1 - Static Slope Stability



Color	Name	Model	Unit Weight (pcf)	Cohesion' (psf)	Phi' (°)	Phi-B (°)	Piezometric Line
Yellow	FG-MFD	Mohr-Coulomb	110	100	28	0	1
Light Green	FG-MFD_Clay	Mohr-Coulomb	110	200	30	0	1
Dark Green	Hillsboro	Mohr-Coulomb	120	600	32	0	1

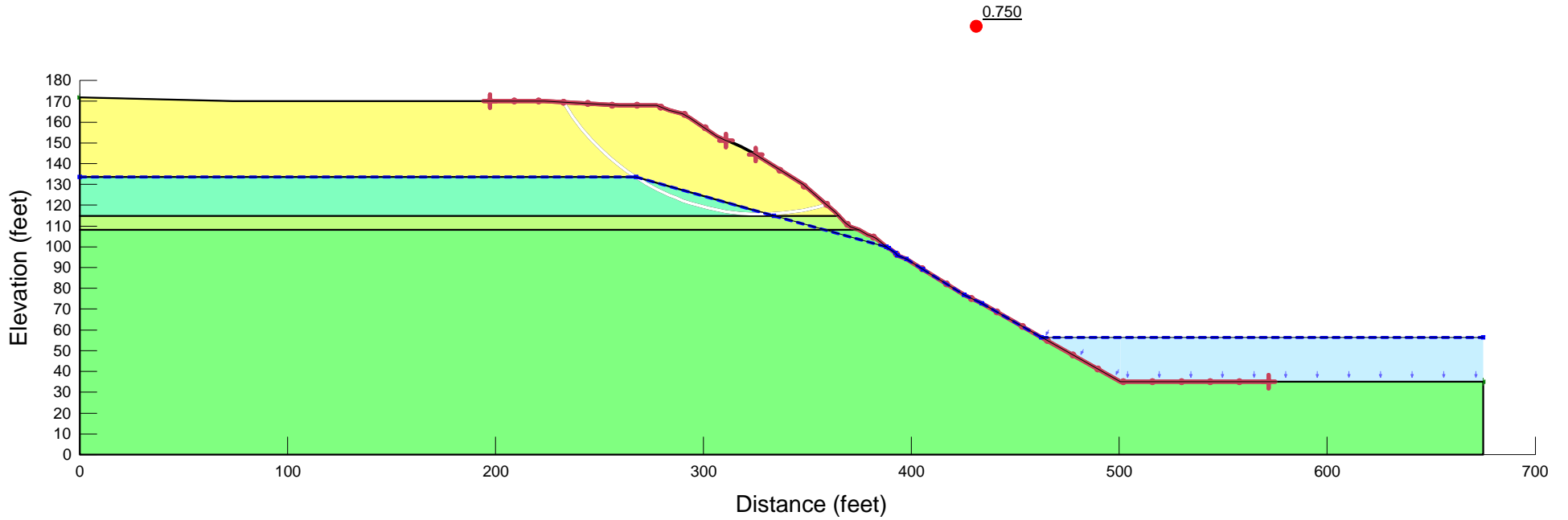
101895 - City of Newberg Water System Resilience
 Figure B-2 - Seismic Slope Stability

Horz Seismic Coef.: 0.237



Color	Name	Model	Unit Weight (pcf)	Cohesion' (psf)	Phi' (°)	Phi-B (°)	Piezometric Line
Yellow	FG-MFD	Mohr-Coulomb	110	100	28	0	1
Light Green	FG-MFD_Clay	Mohr-Coulomb	110	200	30	0	1
Green	Hillsboro	Mohr-Coulomb	120	600	32	0	1

101895 - City of Newberg Water System Resilience
 Figure B-3 - Post-Seismic Slope Stability



Color	Name	Model	Unit Weight (pcf)	Cohesion' (psf)	Phi' (°)	Phi-B (°)	Piezometric Line
Yellow	FG-MFD	Mohr-Coulomb	110	100	28	0	1
Light Green	FG-MFD_Clay	Mohr-Coulomb	110	200	30	0	1
Cyan	FG-MFD_Liquefied	Mohr-Coulomb	110	10	4	0	1
Dark Green	Hillsboro	Mohr-Coulomb	120	600	32	0	1

Important Information

About Your Geotechnical Report

IMPORTANT INFORMATION

CONSULTING SERVICES ARE PERFORMED FOR SPECIFIC PURPOSES AND FOR SPECIFIC CLIENTS.

Consultants prepare reports to meet the specific needs of specific individuals. A report prepared for a civil engineer may not be adequate for a construction contractor or even another civil engineer. Unless indicated otherwise, your consultant prepared your report expressly for you and expressly for the purposes you indicated. No one other than you should apply this report for its intended purpose without first conferring with the consultant. No party should apply this report for any purpose other than that originally contemplated without first conferring with the consultant.

THE CONSULTANT'S REPORT IS BASED ON PROJECT-SPECIFIC FACTORS.

A geotechnical/environmental report is based on a subsurface exploration plan designed to consider a unique set of project-specific factors. Depending on the project, these may include the general nature of the structure and property involved; its size and configuration; its historical use and practice; the location of the structure on the site and its orientation; other improvements such as access roads, parking lots, and underground utilities; and the additional risk created by scope-of-service limitations imposed by the client. To help avoid costly problems, ask the consultant to evaluate how any factors that change subsequent to the date of the report may affect the recommendations. Unless your consultant indicates otherwise, your report should not be used (1) when the nature of the proposed project is changed (for example, if an office building will be erected instead of a parking garage, or if a refrigerated warehouse will be built instead of an unrefrigerated one, or chemicals are discovered on or near the site); (2) when the size, elevation, or configuration of the proposed project is altered; (3) when the location or orientation of the proposed project is modified; (4) when there is a change of ownership; or (5) for application to an adjacent site. Consultants cannot accept responsibility for problems that may occur if they are not consulted after factors that were considered in the development of the report have changed.

SUBSURFACE CONDITIONS CAN CHANGE.

Subsurface conditions may be affected as a result of natural processes or human activity. Because a geotechnical/environmental report is based on conditions that existed at the time of subsurface exploration, construction decisions should not be based on a report whose adequacy may have been affected by time. Ask the consultant to advise if additional tests are desirable before construction starts; for example, groundwater conditions commonly vary seasonally.

Construction operations at or adjacent to the site and natural events such as floods, earthquakes, or groundwater fluctuations may also affect subsurface conditions and, thus, the continuing adequacy of a geotechnical/environmental report. The consultant should be kept apprised of any such events and should be consulted to determine if additional tests are necessary.

MOST RECOMMENDATIONS ARE PROFESSIONAL JUDGMENTS.

Site exploration and testing identifies actual surface and subsurface conditions only at those points where samples are taken. The data were extrapolated by your consultant, who then applied judgment to render an opinion about overall subsurface conditions. The actual interface between materials may be far more gradual or abrupt than your report indicates. Actual conditions in areas not sampled may differ from those predicted in your report. While nothing can be done to prevent such situations, you and your consultant can work together to help reduce their impacts. Retaining

your consultant to observe subsurface construction operations can be particularly beneficial in this respect.

A REPORT'S CONCLUSIONS ARE PRELIMINARY.

The conclusions contained in your consultant's report are preliminary, because they must be based on the assumption that conditions revealed through selective exploratory sampling are indicative of actual conditions throughout a site. Actual subsurface conditions can be discerned only during earthwork; therefore, you should retain your consultant to observe actual conditions and to provide conclusions. Only the consultant who prepared the report is fully familiar with the background information needed to determine whether or not the report's recommendations based on those conclusions are valid and whether or not the contractor is abiding by applicable recommendations. The consultant who developed your report cannot assume responsibility or liability for the adequacy of the report's recommendations if another party is retained to observe construction.

THE CONSULTANT'S REPORT IS SUBJECT TO MISINTERPRETATION.

Costly problems can occur when other design professionals develop their plans based on misinterpretation of a geotechnical/environmental report. To help avoid these problems, the consultant should be retained to work with other project design professionals to explain relevant geotechnical, geological, hydrogeological, and environmental findings, and to review the adequacy of their plans and specifications relative to these issues.

BORING LOGS AND/OR MONITORING WELL DATA SHOULD NOT BE SEPARATED FROM THE REPORT.

Final boring logs developed by the consultant are based upon interpretation of field logs (assembled by site personnel), field test results, and laboratory and/or office evaluation of field samples and data. Only final boring logs and data are customarily included in geotechnical/environmental reports. These final logs should not, under any circumstances, be redrawn for inclusion in architectural or other design drawings, because drafters may commit errors or omissions in the transfer process.

To reduce the likelihood of boring log or monitoring well misinterpretation, contractors should be given ready access to the complete geotechnical engineering/environmental report prepared or authorized for their use. If access is provided only to the report prepared for you, you should advise contractors of the report's limitations, assuming that a contractor was not one of the specific persons for whom the report was prepared, and that developing construction cost estimates was not one of the specific purposes for which it was prepared. While a contractor may gain important knowledge from a report prepared for another party, the contractor should discuss the report with your consultant and perform the additional or alternative work believed necessary to obtain the data specifically appropriate for construction cost estimating purposes. Some clients hold the mistaken impression that simply disclaiming responsibility for the accuracy of subsurface information always insulates them from attendant liability. Providing the best available information to contractors helps prevent costly construction problems and the adversarial attitudes that aggravate them to a disproportionate scale.

READ RESPONSIBILITY CLAUSES CLOSELY.

Because geotechnical/environmental engineering is based extensively on judgment and opinion, it is far less exact than other design disciplines. This situation has resulted in wholly unwarranted claims

being lodged against consultants. To help prevent this problem, consultants have developed a number of clauses for use in their contracts, reports, and other documents. These responsibility clauses are not exculpatory clauses designed to transfer the consultant's liabilities to other parties; rather, they are definitive clauses that identify where the consultant's responsibilities begin and end. Their use helps all parties involved recognize their individual responsibilities and take appropriate action. Some of these definitive clauses are likely to appear in your report, and you are encouraged to read them closely. Your consultant will be pleased to give full and frank answers to your questions.

The preceding paragraphs are based on information provided by the ASFE/Association of Engineering Firms Practicing in the Geosciences, Silver Spring, Maryland

IMPORTANT INFORMATION



Appendix C: Vulnerability Assessments



WATER SYSTEM SEISMIC RESILIENCE STUDY

**CITY OF NEWBERG PUBLIC WORKS DEPARTMENT
NEWBERG, OREGON**

Final Technical Memorandum: Seismic Vulnerability Assessment of Water System

July 2nd, 2020

SEFT Project Number: B19009.00

Table of Contents

List of Figures	ii
List of Tables	vi
1.0 Introduction and Background	1
1.1 City of Newberg Water System Description.....	1
1.2 Seismic Resilience Study.....	1
2.0 Evaluation Methodology and Seismic Performance Objectives	5
2.1 Seismic Hazard	5
2.2 Seismic Performance Objectives	5
2.2.1 Structural Performance Objective	5
2.2.2 Nonstructural Performance Objectives	5
2.3 Water System Evaluation Methodology	6
3.0 Expected Seismic Structural and Nonstructural Performance	7
3.1 Corral Creek Road Reservoir	7
3.2 North Valley Reservoir No. 1	10
3.3 North Valley Reservoir No. 2	15
3.4 Water Treatment Plant	18
3.4.1 Original Treatment/Control Building (pre-1961)	20
3.4.2 1961 Treatment/Control Building Addition.....	32
3.4.3 1970 Treatment/Control Building Addition.....	36
3.4.4 Sedimentation Basin No. 1.....	44
3.4.5 Filters No.1 to 4, Filter Gallery, Pump Room, and Associated Clearwell.....	50
3.4.6 Sodium Hypochlorite Generation Building.....	62
3.4.7 On-site Electrical Components	75
4.0 Next Steps	79
5.0 Limitations	80
References	81

List of Figures

Figure 1.1 – City of Newberg Water System General Location Map	4
Figure 3.1 – Corral Creek Road Reservoir	8
Figure 3.2 – Electrical Panelboard and SCADA Equipment Enclosure and Canopy	9
Figure 3.3 – Unrestrained Backup Batteries	9
Figure 3.4 – North Valley Reservoir No. 1	12
Figure 3.5 – North Valley Reservoir No. 1 Cross-Section	12
Figure 3.6 – Former Chlorination Building	13
Figure 3.7 – Dome Anchor Detail	13
Figure 3.8 – Reservoir No. 1 Vertical Inlet Nozzles not Braced to Structure	14
Figure 3.9 – Backup Batteries not Adequately Restrained	14
Figure 3.10 – SCADA Antenna Supported with Friction Clips	15
Figure 3.11 – North Valley Reservoir No.2	17
Figure 3.12 – Reservoir No. 2 Vertical Inlet Nozzles not Braced to Structure	17
Figure 3.13 – Newberg Water Treatment Plant Location Map	19
Figure 3.14 – Original Treatment/Control Building (pre-1961)	23
Figure 3.15 – Large Diaphragm Opening Adjacent to Shear Walls	23
Figure 3.16 – Seismic Joint Between Original Treatment/Control Building (pre-1961) and 1961 Addition	24
Figure 3.17 – Concrete Wall Penetration by Raw Water Pipe	24
Figure 3.18 – Raw Water Piping System without Adequate Bracing	25
Figure 3.19 – Vertical Pipe without Lateral Restraint	25
Figure 3.20 – Unrestrained Chemical Storage Containers	26
Figure 3.21 – Unrestrained Rolling Carts	26
Figure 3.22 – Storage Cabinet Restrained with U-Bolt to Electrical Conduits	27
Figure 3.23 – Unrestrained Storage Rack	27
Figure 3.24 – Mechanical Ducts not Braced to Structure	28
Figure 3.25 – In-Line Fan Unit Unrestrained to Movement Parallel to Wall	28
Figure 3.26 – Electrical Conduits not Seismically Braced and without Flexible Connections to Cabinets	29

Figure 3.27 – Electrical Cabinets with Missing Anchor at the Base 29

Figure 3.28 – Unbraced Cast Iron (Brittle) Vertical Pipe next to Electrical Cabinet
..... 30

Figure 3.29 – Lights on Pendant Supports not Restrained and without Lens
Covers 30

Figure 3.30 – Unrestrained Refrigerator and Filing Cabinets Adjacent to Walkway
..... 31

Figure 3.31 – 1961 Treatment/Control Building Addition..... 33

Figure 3.32 – Shear Wall not Continuous to Foundation (Blue Shaded) and with
Split Level Diaphragms (Red Shaded) (Source Drawings: “Water Treatment
Plant Addition (A610001)”) 34

Figure 3.33 – Unrestrained Storage Rack 34

Figure 3.34 – Porta-Torch Gas Cylinders and Air compressor Stored on Top
Shelf 35

Figure 3.35 – Unrestrained Computer Equipment 35

Figure 3.36 – 1970 Treatment/Control Building Addition..... 38

Figure 3.37 – Reduction of Shear Walls Cross Section Due to Presence of
Windows and Door..... 38

Figure 3.38 – Flexible Diaphragm Chords without Cross Ties 39

Figure 3.39 – Joist to Perpendicular Wall Connection 39

Figure 3.40 – Detail of Joist to Adjacent Wall Connection..... 40

Figure 3.41 – CMU Wall Partitions not Isolated from Structure 40

Figure 3.42 – Unrestrained Computer Equipment 41

Figure 3.43 – Unrestrained Equipment on Lab Counter 41

Figure 3.44 – Chemical Cabinet Doors without Proper Latches 42

Figure 3.45 – Water Heater Tank not Adequately Restrained 42

Figure 3.46 – Light Fixture Supported by Ceiling Grid..... 43

Figure 3.47 – Sedimentation Basin No. 1 Structure 46

Figure 3.48 – Construction Joint Between Sedimentation Basins No. 1 (1961
Construction) and No. 2 (pre-1961 Construction) 46

Figure 3.49 – Insufficient Freeboard (~7 in) to Accommodate Sloshing Waves in
Sedimentation Basin Near Sodium Hydroxide Building..... 47

Figure 3.50 – Sedimentation Basins Effluent Structure (Outlet Basin Structure) . 47

Figure 3.51 – Wooden Baffles in Sedimentation Basin No. 1 48

Figure 3.52 – Weir Trough to Basin Structure Connection Using Small Diameter Anchors..... 48

Figure 3.53 – Raw Water Pipes Penetrating Concrete Wall without Adequate Flexibility Through Wall..... 49

Figure 3.54 – Filters No. 1 to 4 and Filter Gallery Roof Slab..... 53

Figure 3.55 – Pump Room 54

Figure 3.56 – Shear Wall not Continuous to Foundation..... 54

Figure 3.57 – Filter Gallery Seismic Joint (Between 1970 Construction and 2005 Expansion)..... 55

Figure 3.58 – Split Level Diaphragms..... 55

Figure 3.59 – Flexible Diaphragm without Cross Ties 56

Figure 3.60 – Joist to Perpendicular Wall Connection 56

Figure 3.61 – Control/Treatment Building (1970) and Filter Floor/Roof Levels not Aligned..... 57

Figure 3.62 – Finished Water Sample Pipe and Filter Backwash Pipe Cross Seismic Joint without Adequate Flexibility 57

Figure 3.63 – Air Scour Pipe Crosses Seismic Joint without Adequate Flexibility 58

Figure 3.64 – Valves and Valve Actuators Installed In-Line with Piping Systems not Independently Braced..... 58

Figure 3.65 – Air Scour Piping from Blowers to Filter Gallery without Adequate Flexibility to Accommodate Differential Movement 59

Figure 3.66 – Air Vent Valve and Muffler not Adequately Braced..... 59

Figure 3.67 – Air Relief Piping Penetrating Laterally Unrestrained..... 60

Figure 3.68 – Pump Motors not Braced to Structure Above their Center of Gravity 60

Figure 3.69 – Electrical Transformer not Adequately Braced Against Movement Parallel to Wall 61

Figure 3.70 – Valve Actuators Installed on Significantly Modified Base Plates ... 61

Figure 3.71 – Sodium Hypochlorite Generation Building..... 64

Figure 3.72 – Scheme of Building Lateral Force Resisting Systems 64

Figure 3.73 – Single Lateral Force Resisting Bay in Frame Line along East-West Direction..... 65

Figure 3.74 – Single Lateral Force Resisting Bay in Frame Line along North-South Direction..... 65

Figure 3.75 – Inadequate Load Path from Roof Diaphragm to Moment Frame Beams (no Blocking between Purlins) 66

Figure 3.76 – Indirect Load Path from Diaphragm to Brace Frame 66

Figure 3.77 – View of Moment Frame Connection and Panel Zone 67

Figure 3.78 – Purlins Between Diaphragm Chords..... 67

Figure 3.79 – UngROUTed Base Plate and Nuts on Anchor Rods not Tight..... 68

Figure 3.80 – Piping Connecting Salt Brine Tank to Sodium Hypochlorite Generation Building without Adequate Flexibility 68

Figure 3.81 – Lack of Flexibility in Salt Brine Tank Drain Pipe 69

Figure 3.82 – Unbraced PVC Vent Piping 69

Figure 3.83 – Lack of Flexibility of Piping Connecting Sodium Hypochlorite Tanks 70

Figure 3.84 – Lack of Flexibility in Piping between Sodium Hypochlorite Generator and Attachment to Building..... 70

Figure 3.85 – Deficient Anchorage Between Chemical Feed Pumps and Concrete Support..... 71

Figure 3.86 – Water Heater not Adequately Restrained and Unrestrained Barrel 71

Figure 3.87 – Water Softener Components not Restrained 72

Figure 3.88 – Instant Hot Water Heater not Adequately Restrained..... 72

Figure 3.89 – Control Panel not Adequately Braced..... 73

Figure 3.90 – Transformer not Adequately Braced 73

Figure 3.91 – Unrestrained Light Fixtures 74

Figure 3.92 – Emergency Generator 76

Figure 3.93 – Electrical Switchgear 76

Figure 3.94 – Electrical Transformer..... 77

Figure 3.95 – Missing Anchors on Switchgear to Concrete Pad Connection 77

Figure 3.96 – Electrical Transformer not Anchored to Concrete Pad 78

List of Tables

Table 1.1 – Summary of Water System Components Evaluated by SEFT	2
Table 1.2 – Evaluation Documents	3
Table 3.1 – Corral Creek Road Reservoir Seismic Evaluation Summary	8
Table 3.2 – North Valley Reservoir No. 1 Seismic Evaluation Summary	11
Table 3.3 – North Valley Reservoir No. 2 Seismic Evaluation Summary	16
Table 3.4 – Original Treatment/Control Building (pre-1961) Seismic Evaluation Summary	21
Table 3.5 – 1961 Treatment/Control Building Addition Seismic Evaluation Summary	33
Table 3.6 – 1970 Treatment/Control Building Addition Seismic Evaluation Summary	37
Table 3.7 – Sedimentation Basin No. 1 Evaluation Summary.....	45
Table 3.8 – Filters No. 1 to 4, Filter Gallery, Pump Room, and Associated Clearwell Structure Seismic Evaluation Summary	51
Table 3.9 – Sodium Hypochlorite Generation Building Seismic Evaluation Summary	62
Table 3.10 – On-site Electrical Components Seismic Evaluation Summary	75

1.0 Introduction and Background

1.1 City of Newberg Water System Description

The City of Newberg water system currently consists of the City’s wellfield, raw water transmission pipelines, water treatment plant, three water storage reservoirs, one pump station, and distribution system pipelines. The entire water service area is one pressure zone, except for approximately 40 customers that are served by the Oak Knoll booster pump station. The system uses approximately 56 miles of distribution pipelines to provide water to business and residential customers within the City of Newberg service area and six small water district wholesale customers. The primary water supply is the City’s well field located on the south side of the Willamette River in Marion County. Two raw water transmission mains cross the river to the treatment plant. An under river 30-inch diameter high density polyethylene transmission main can supply 100% of the treatment plant capacity. An older 24-inch diameter cast iron transmission main is supported by a decommissioned highway bridge. The City’s water treatment plant is a conventional filtration facility with a nominal capacity of 9 million gallons per day (MGD). The current average day demand for the water system is approximately 2.4 MGD and summertime demands can increase to approximately 4.5 MGD.

1.2 Seismic Resilience Study

Based on recommendations contained in the 2017 City of Newberg Water Master Plan and requirements of the Oregon Health Authority, the City of Newberg is conducting a water system seismic resilience study. This study will evaluate the expected performance of the City water system following a Magnitude 9.0 (M9.0) Cascadia Subduction Zone (CSZ) earthquake and identify preliminary recommendations for improvements that should be implemented to enable the City to more rapidly restore water service after a major earthquake, to meet community social and economic needs. The scope of this seismic resilience study includes:

1. Define water system level of service (LOS) goals for the City water system following a major seismic event;
2. Identify key backbone system components that are required to achieve these LOS goals, including the locations of key supply points for water for fire suppression and community water distribution;
3. Define performance criteria for individual system components that are required to achieve these LOS goals;
4. Conduct a limited geotechnical seismic hazards evaluation for the City water system and slope stability analysis at the water treatment plant site (Shannon & Wilson);
5. Conduct a limited well/pipeline (HDR), and structural/nonstructural (SEFT/HDR) vulnerability assessment to determine estimated system performance following a M9.0 CSZ earthquake;

6. Identify gaps between the LOS goals and current performance estimates; and
7. Develop preliminary mitigation recommendations to close these gaps utilizing new or retrofit infrastructure, changes to design standards, enhancements in emergency response planning, and recommendations for further study.

This Technical Memorandum (TM) presents SEFT’s findings related to scope item 5. The components of the water system that have been evaluated by SEFT as part of this effort are summarized in Table 1.1. The locations of these components are illustrated in Figure 1.1. To complete this scope of work, SEFT utilized the Task 2 TM (Seismic Recovery Goals) and Task 3 TM (Seismic Hazards Summary), completed as part of this project, and the as-built drawings indicated in Table 1.2.

Table 1.1 – Summary of Water System Components Evaluated by SEFT

Water System Component	Structure Type	Year of Original Construction
Corral Creek Road Reservoir		
4.0 MG Reservoir	Strand-Wound Circular Prestressed Concrete	2004
North Valley Reservoirs		
4.0 MG Reservoir No.1	Strand-Wound Circular Prestressed Concrete	1961
4.0 MG Reservoir No.2	Strand-Wound Circular Prestressed Concrete	1977
Water Treatment Plant		
Original Treatment/Control Building	Reinforced concrete	pre-1961
1961 Treatment/Control Building Addition	Reinforced concrete	1961
1970 Treatment/Control Building Addition	Reinforced concrete	1970
Sedimentation Basin No.1	Reinforced concrete	1961
Filters No.1 and 2, Filter Gallery, Pump Room, Clearwell, and Filters No. 3 and 4 Addition	Reinforced concrete	1970 1980 (Filters No. 3 and 4)
Sodium Hypochlorite Generation Building	Steel Moment Resisting Frame (North-South) and Steel Brace Frame (East-West)	2005

Table 1.2 – Evaluation Documents

As-Built Drawings	Water System Component
Corral Creek Road Reservoir	
“4.0 Million Gallon Corral Creek Road Reservoir (A2004001)” prepared by CH2MHill, dated April 2002	<ul style="list-style-type: none"> • Corral Creek Road Reservoir
North Valley Reservoirs	
“North Valley 4.0 MG West Reservoir (A600001)” prepared by Carl E. Green & Associates Consulting Engineers, dated August 1960	<ul style="list-style-type: none"> • North Valley Reservoir No.1
“Site Work For Reservoir No.2 (A770016)” prepared by Robert E. Meyer Engineers Inc., dated November 1977	<ul style="list-style-type: none"> • North Valley Reservoir No.2
“North Valley and Corral Creek Reservoirs Seismic Upgrades (A2016007)” prepared by Kennedy/Jenks Consultants, dated September 2015	<ul style="list-style-type: none"> • Modifications in North Valley Reservoir No.1 • Modifications and seismic upgrade of North Valley Reservoir No.2
Water Treatment Plant	
“Water Treatment Plant (A500002)” prepared by John Cunningham & Associates Consulting Engineers, dated December 1950	<ul style="list-style-type: none"> • Not applicable ⁽¹⁾
“Water Treatment Plant Addition (A610001)” prepared by Carl E. Green & Associates Consulting Engineers, dated April 1961	<ul style="list-style-type: none"> • Treatment/Control Building (1961 Addition) • Sedimentation Basin No.1
“Water Treatment Plant (A700004)” prepared by CH2M, dated July 1970	<ul style="list-style-type: none"> • Treatment/Control Building (1970 Addition) • Filters No.1 and 2, Filter Gallery, Pump Room, and Clearwell
“Water Treatment Plant Expansion (A800027)” prepared by Kramer, Chin & Mayo, Inc. Consulting Engineers, dated July 1980	<ul style="list-style-type: none"> • Filters No. 3 and 4
“Water Treatment Plant Improvements Project (A2002014)” prepared by MWH, dated September 2002	<ul style="list-style-type: none"> • Modifications to Filters No. 1 to 4 and Filter Gallery
“Water Treatment Plant Expansion to 9.5 MGD (A2007005)” prepared by CH2MHill, dated March 2005	<ul style="list-style-type: none"> • Sodium Hypochlorite Generation Building • Modifications to Filters No. 1 to 4, Treatment/Control Building, and Sedimentation Basin No.1

Notes:

(1) The geometry and location of the structures shown in these drawings are inconsistent with current plant layout.



Figure 1.1 – City of Newberg Water System General Location Map

2.0 Evaluation Methodology and Seismic Performance Objectives

2.1 Seismic Hazard

This evaluation considered a single seismic hazard level associated with a M9.0 scenario earthquake originating on the Cascadia Subduction Zone (CSZ). As part of this project, Shannon and Wilson, Inc. conducted a geotechnical seismic hazard assessment (Shannon & Wilson, 2019). In their report, Shannon & Wilson provided estimates of the spectral acceleration and permeant ground deformation (PGD) for liquefaction-induced settlement, liquefaction-induced lateral spreading, and earthquake-induced landslide associated with the M9.0 CSZ scenario earthquake. This geotechnical data was used as the basis for SEFT’s structural evaluation.

2.2 Seismic Performance Objectives

In the initial phase of this project, the HDR/SEFT team worked with the City of Newberg to establish proposed level of service (LOS) goals for the City of Newberg water system following a major earthquake as described in SEFT (2019). The structural and nonstructural performance objectives used for evaluation of water system components for the M9.0 CSZ scenario earthquake were based on these LOS goals and are described in Sections 2.2.1 and 2.2.2.

2.2.1 Structural Performance Objective

Immediate Occupancy: “Immediate Occupancy” refers to the post-earthquake damage state in which only very limited structural damage has occurred. The basic vertical- and lateral-force-resisting systems of the building retain almost all their pre-earthquake strength and stiffness. The risk of life-threatening injury from structural damage is very low, and although some minor structural repairs might be appropriate, these repairs would generally not be required before re-occupancy. Continued use of the building is not limited by its structural condition but might be limited by damage or disruption to nonstructural elements of the building, furnishings, or equipment and availability of external utility services.

2.2.2 Nonstructural Performance Objectives

Operational: “Operational” refers to the performance level where most nonstructural systems required for normal use of the building are functional, although minor cleanup and repair of some items might be required. Achieving the Operational nonstructural performance level requires considerations of many elements beyond those that are normally within the sole province of the structural engineer’s responsibilities. For Operational nonstructural performance, in addition to ensuring that nonstructural components are properly mounted and braced within the structure, it is often necessary to provide emergency standby equipment to provide utility services from external sources

that might be disrupted. It might also be necessary to perform qualification testing to ensure that all necessary equipment will function during or after strong shaking.

2.3 Water System Evaluation Methodology

The seismic structural evaluation of components within the City of Newberg water system was completed using the Tier 1 procedure of ASCE 41-17, *Seismic Evaluation and Retrofit of Existing Buildings* (ASCE, 2017b). This Tier 1 procedure uses a checklist-based approach to identify potential seismic structural deficiencies that have been commonly observed in past earthquakes. The Tier 1 procedure also uses quick-check calculations to evaluate potential deficiencies in the primary components of the seismic load resisting system.

However, ASCE 41-17 does not include quick-check calculations and acceptance criteria that are directly applicable to the reservoirs evaluated as part of this study. Therefore, in place of these quick-check calculations, American Water Works Association (AWWA) standard design checks were evaluated for primary components of the seismic load path (circumferential strand, seismic cables, etc.). The calculation of seismic forces acting on the reservoirs has been based on the applicable AWWA standard. Concrete tank seismic loads were based on AWWA D110-13, *Wire- and Strand-Wound, Circular, Prestressed Concrete Water Tanks* (AWWA, 2013).

Freeboard calculations were completed based on both the applicable AWWA design standard and ASCE 7-16, *Minimum Design Loads for Buildings and Other Structures* (ASCE, 2017a). The required freeboard calculated using ASCE 7-16 varies from that calculated using the AWWA standards. This study used the more conservative of the freeboard estimates calculated using both methods. The recommended freeboard calculations used a seismic importance factor equal to 1.0, as indicated in the applicable standards. In order to ensure Immediate Occupancy structural performance for the M9.0 CSZ event, we have increased the calculated freeboard values by a factor equal to 1.5.

The seismic nonstructural evaluation of components within the City of Newberg water system was completed using the nonstructural seismic evaluation checklists presented in ASCE 41-17 supplemented by TCLEE Monograph No. 22, *Seismic Screening Checklists for Water and Wastewater Facilities* (TCLEE, 2002). Similar to the ASCE 41 Tier 1 structural evaluation procedure, this checklist-based evaluation approach is used to identify potential seismic nonstructural deficiencies that have been commonly observed in past earthquakes.

3.0 Expected Seismic Structural and Nonstructural Performance

The expected structural and nonstructural seismic performance of the City of Newberg water system components has been evaluated for a M9.0 CSZ scenario earthquake. Sections 3.1 through 3.4 provide a short narrative description of the water system component evaluated, followed by a table that summarizes the potential seismic structural and nonstructural deficiencies identified by the seismic evaluation using the ASCE 41-17 Tier 1 and TCLEE Monograph No. 22 checklist-based procedures. These sections also include images from the as-built drawings where structural deficiencies are identified and selected photos taken during site visits conducted on August 9th and 16th, 2019.

3.1 Corral Creek Road Reservoir

The Corral Creek Road Reservoir, built in 2004, is a partially buried 4 million-gallon (MG) strand-wound circular prestressed concrete water tank with a nearly flat roof (see Figure 3.1). The tank is 138 ft. in diameter and approximately 40 ft. tall. The roof of the reservoir is supported by circular concrete columns. It is one of the three reservoirs that provide water storage for the city.

The circular concrete wall is reinforced with a combination of mild steel reinforcement, vertical post-tensioning bars and horizontal prestressing strands around the exterior surface to resist internal hydrostatic pressure and seismic forces. A continuous strip footing supports the exterior walls. The connection between the walls and footings is typically composed of a bearing pad and diagonal seismic cables that are anchored into the tank wall and foundation. The seismic cables are de-bonded at the wall to foundation interface. This connection allows the tank to shrink and swell radially, as needed to accommodate varying internal pressure due to changes in the water level inside the tank. The roof is connected to the walls using a series of shear keys constructed using vertical HSS posts designed to prevent the roof from sliding off the structure in an earthquake, but also allows the tank to shrink and swell radially.

An electrical panelboard and SCADA equipment is located adjacent to the reservoir in a metal electrical enclosure. The enclosure is covered by a canopy that is supported by steel tube section cantilever posts, as shown in Figure 3.2.

Table 3.1 presents a summary of potential seismic structural and nonstructural deficiencies identified by this evaluation. Based on the potential deficiencies identified in Table 3.1, the Corral Creek Road Reservoir is currently expected to achieve Immediate Occupancy structural performance but is not currently expected to achieve Operational nonstructural performance for a M9.0 CSZ earthquake.

Table 3.1 – Corral Creek Road Reservoir Seismic Evaluation Summary

Potential Deficiencies	Description
Structural	<ul style="list-style-type: none"> • Per Shannon & Wilson Report, minimal permanent ground deformation (PGD) is anticipated at the reservoir: 0 inches liquefaction induced settlement, 0-0.1 inches liquefaction-induced lateral spreading, and approximately 0.5 feet earthquake-induced landslide PGD near slope 100 feet from reservoir. This level of PGD is not anticipated to cause significant structural damage to the reservoir. However, the impact of earthquake-induced landslide PGD should be considered as a potential hazard for the buried pipelines that connect to the reservoir and are located in the potential landslide zone. • None Identified.
Nonstructural	<ul style="list-style-type: none"> • SCADA system backup batteries inside metal enclosure are not restrained. See Figure 3.3.



Figure 3.1 – Corral Creek Road Reservoir



Figure 3.2 – Electrical Panelboard and SCADA Equipment Enclosure and Canopy



Figure 3.3 – Unrestrained Backup Batteries

3.2 North Valley Reservoir No. 1

North Valley Reservoir No. 1, built in 1960, is a partially buried 4 MG strand-wound circular prestressed concrete water tank with a concrete dome roof, as shown in Figure 3.4. The tank is 144 ft. in diameter by approximately 52 ft. tall (at the dome center). At the middle of the reservoir, there is a 90 ft. diameter flat bottom slab that transitions to a sloped reservoir bottom (2 horizontal to 1 vertical) up to the top of the wall footing, approximately 13.5 ft. above the flat slab elevation, as can be observed in Figure 3.5. The maximum water surface is approximately 17 ft below the center of the dome, and 1 ft above the top of the walls. It is one of the three reservoirs that provide water storage for the city.

The circular concrete wall is reinforced with a combination of mild steel reinforcement, vertical post-tensioning bars and horizontal prestressing strand around the exterior surface to resist internal pressure. A continuous strip footing supports the exterior walls. The connection between the wall and footing is typically composed of a bearing pad and diagonal seismic cables that are anchored into the tank wall and foundation. The seismic cables are de-bonded at the wall to foundation interface. This connection allows the tank to shrink and swell radially, as needed to accommodate varying internal pressure due to changes in the water level inside the tank. The dome is anchored to the wall by 1 in diameter galvanized bolts (eight, equally spaced) with rubber pads in the interface.

An electrical panelboard, SCADA equipment, and analyzer equipment are located in the former Chlorination Building at the site, as shown in Figure 3.6. The building is a single-story minimally reinforced masonry wall structure with a straight-sheathed wood roof diaphragm.

Table 3.2 presents a summary of potential seismic structural and nonstructural deficiencies identified by this evaluation. Based on the potential deficiencies identified in Table 3.2, the North Valley Reservoir No.1 is not currently expected to achieve Immediate Occupancy structural performance or Operational nonstructural performance for a M9.0 CSZ earthquake. Additionally, based on the potential deficiencies identified in this assessment, the former Chlorination Building is not currently expected to achieve Life Safety performance and represents a safety hazard to City staff and contractors.

Table 3.2 – North Valley Reservoir No. 1 Seismic Evaluation Summary

Potential Deficiencies	Description
Structural	<ul style="list-style-type: none"> • Per Shannon & Wilson Report, minimal permanent ground deformation (PGD) is anticipated at the reservoir: 0.5-1.5 inches liquefaction induced settlement, 0-0.1 inches liquefaction-induced lateral spreading, and approximately 2 feet earthquake-induced landslide PGD near slope 150 feet from reservoir. This level of PGD may cause structural damage to and/or leaking of the reservoir. Additionally, the impact of earthquake-induced landslide PGD should be considered as a potential hazard for the buried pipelines that connect to the reservoir and are located in the potential landslide zone. • The number of dome anchors (8 anchors) is insufficient to transfer the expected seismic forces from the dome to the reservoir walls. See Figure 3.7. • The existing capacity of the horizontal prestressing on the wall of the reservoir is insufficient to resist the combination of hydrostatic and expected hydrodynamic hoop forces during the earthquake. • The seismic cables provided at the base of the wall are insufficient to resist the expected hydrodynamic forces at the base of the reservoir during an earthquake.
Nonstructural	<ul style="list-style-type: none"> • Reservoir vertical inlet nozzles are not braced and may not be adequate to resist earthquake-induced hydrodynamic forces. See Figure 3.8. • SCADA system and chemical analyzer equipment that is used for monitoring of reservoirs is located in the former Chlorination Building that would likely not perform well during an earthquake. • SCADA system backup batteries in the former Chlorinator Building are not adequately restrained to prevent movement during an earthquake. See Figure 3.9. • Friction Clips are used to restrain the SCADA antenna, see Figure 3.10. However, friction clips are generally not considered to be reliable to resist earthquake-induced forces.



Figure 3.4 – North Valley Reservoir No. 1

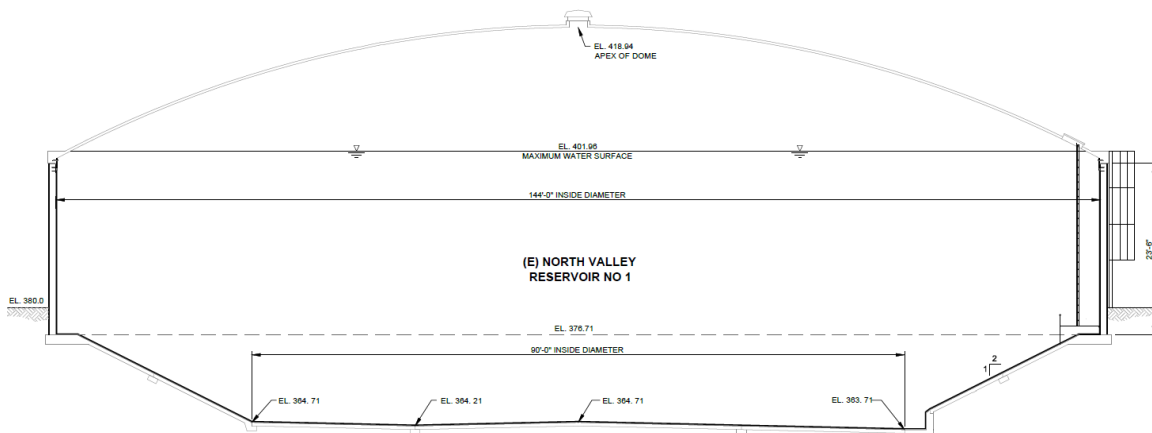


Figure 3.5 – North Valley Reservoir No. 1 Cross-Section
(Source Drawings: “North Valley and Corral Creek Reservoirs Seismic Upgrades (A2016007)”)



Figure 3.6 – Former Chlorination Building

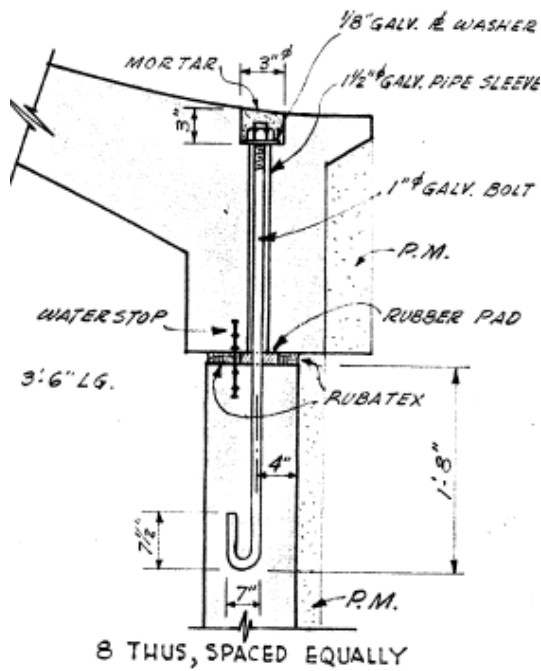


Figure 3.7 – Dome Anchor Detail
 (Source Drawings: “North Valley 4.0 MG West Reservoir (A600001)”)

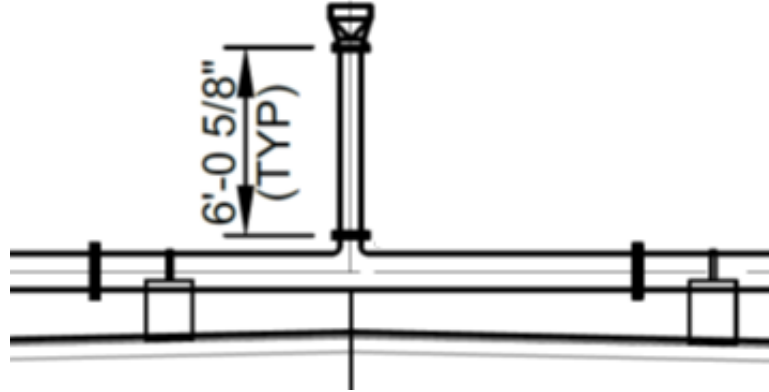


Figure 3.8 – Reservoir No. 1 Vertical Inlet Nozzles not Braced to Structure
(Source Drawings: “North Valley and Corral Creek Reservoirs Seismic Upgrades (A2016007)”)



Figure 3.9 – Backup Batteries not Adequately Restrained



Figure 3.10– SCADA Antenna Supported with Friction Clips

3.3 North Valley Reservoir No. 2

North Valley Reservoir No. 2 is a partially buried 4 MG strand-wound circular prestressed concrete water tank with a concrete dome roof (see Figure 3.11). The reservoir was originally constructed in 1977 and seismically upgraded in 2015. The tank is 151 ft. in diameter by approximately 47 ft. tall (by the dome center). The maximum water surface is approximately 17 ft below the center of the dome. It is one of the three reservoirs that provide water storage for the city.

The circular concrete wall is reinforced with a combination of mild steel reinforcement, vertical post-tensioning bars and horizontal prestressing strand around the exterior surface to resist internal pressure. A continuous strip footing supports the exterior walls. The connection between the wall and footing is typically composed of a bearing pad and diagonal seismic cables that are anchored into the tank wall and foundation. The seismic cables are de-bonded at the wall to foundation interface. This connection allows the tank to shrink and swell radially, as needed to accommodate varying internal pressure due to changes in the water level inside the tank. The dome is connected to the walls through a continuous shear key to prevent the roof from sliding off the structure.

The recent seismic upgrade included providing additional horizontal prestress strands over the height of the ring beam at the top of the reservoir wall and strengthening the wall to foundation connection at 148 locations around the inside perimeter of the tank to prevent the reservoir from sliding during an earthquake. Design calculations from this 2015 seismic upgrade by Kennedy/Jenks were not available for SEFT’s review as part of this seismic vulnerability assessment.

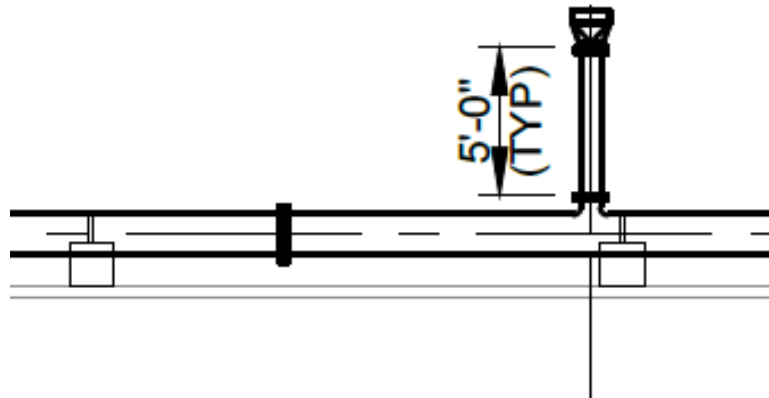
Table 3.3 presents a summary of potential seismic structural and nonstructural deficiencies identified by this evaluation. Based on the potential deficiencies identified in Table 3.3, the North Valley Reservoir No. 2 is not currently expected to achieve Immediate Occupancy structural performance or Operational nonstructural performance for a M9.0 CSZ earthquake.

Table 3.3 – North Valley Reservoir No. 2 Seismic Evaluation Summary

Potential Deficiencies	Description
Structural	<ul style="list-style-type: none"> • Per Shannon & Wilson Report, minimal permanent ground deformation (PGD) is anticipated at the reservoir: 0.5-1.5 inches liquefaction induced settlement, 0-0.1 inches liquefaction-induced lateral spreading, and approximately 2 feet earthquake-induced landslide PGD near slope 150 feet from reservoir. This level of PGD may cause structural damage to and/or leaking of the reservoir. Additionally, the impact of earthquake-induced landslide PGD should be considered as a potential hazard for the buried pipelines that connect to the reservoir and are located in the potential landslide zone. • The existing capacity of the horizontal prestressing on the wall of the reservoir is insufficient to resist the combination of hydrostatic and expected hydrodynamic hoop forces during the earthquake, when neglecting the contribution of the soil passive earth pressure.
Nonstructural	<ul style="list-style-type: none"> • Same as North Valley Reservoir No. 1, see Table 3.2. See Figure 3.12 related to the unbraced inlet nozzles inside the reservoir.



Figure 3.11 – North Valley Reservoir No.2



**Figure 3.12 – Reservoir No. 2 Vertical Inlet Nozzles not Braced to Structure
(Source Drawings: “North Valley and Corral Creek Reservoirs Seismic Upgrades
(A2016007)”)**

3.4 Water Treatment Plant

The City of Newberg Water Treatment Plant (WTP) receives raw water from the well field located across the Willamette River, and after treatment, finished water is pumped to the distribution system and the City's three finished water reservoirs. The WTP is located approximately 2.5 miles southwest of Corral Creek Road Reservoir and approximately 3.4 miles south-southeast of North Valley Reservoirs.

The WTP consists of the following buildings and process units (those shown in bold text were included in the scope of the current seismic vulnerability assessment), as illustrated in Figure 3.13:

- **Original Treatment/Control Building (pre-1961)**
- **1961 Treatment/Control Building Addition**
- **1970 Treatment/Control Building Addition**
- **Sedimentation Basin No. 1 (North)**
- Sedimentation Basin No. 2 (South)
- **Filters No. 1 to 4, Filter Gallery, Pump Room, and associated Clearwell**
- Filter No. 5 and 6, and associated Clearwell
- **Sodium Hypochlorite Generation Building**
- Sodium Hydroxide Building
- Backwash Basin

The City of Newberg WTP was originally built prior to 1961. Available drawings from 1950 show structures with a geometry and layout that is inconsistent with the current plant configuration. Drawings from 1961 show a portion of the Treatment/Control Building and Sedimentation Basin No. 2 (south basin) as existing structures. It is assumed that these structures were constructed after 1950 and prior to 1961. The original plant had a capacity of approximately 1 MGD. Several plant upgrades and expansions have occurred since original construction to increase the plant capacity to 9.5 MGD. These upgrade and expansion projects have included:

- Treatment/Control Building Addition and Sedimentation Basin No. 1 (north basin) were constructed in 1961;
- A second Treatment/Control Building Addition, Filters No.1 and 2, Filter Gallery, Pump Room, and Clearwell were constructed in 1970;
- Filters No. 3 and 4 were constructed in 1980;
- Sodium Hydroxide Building was constructed in 2002; and
- Sodium Hypochlorite Generation Building and Filters No. 5 and 6 (with associated expansion of the Clearwell and Filter Gallery) were constructed in 2005.

A number of these treatment plant structures were constructed in close proximity to other structures and lack an adequate seismic joint (i.e., gap) to prevent potential pounding between the adjacent structures. Differential response of the adjacent structures during an earthquake would likely result in pounding between the structures that would cause localized damage to one or both adjacent structures. The seismic vulnerability assessment summaries in the following sections indicate where lack of an adequate seismic joint between adjacent structures has been identified as a potential deficiency.

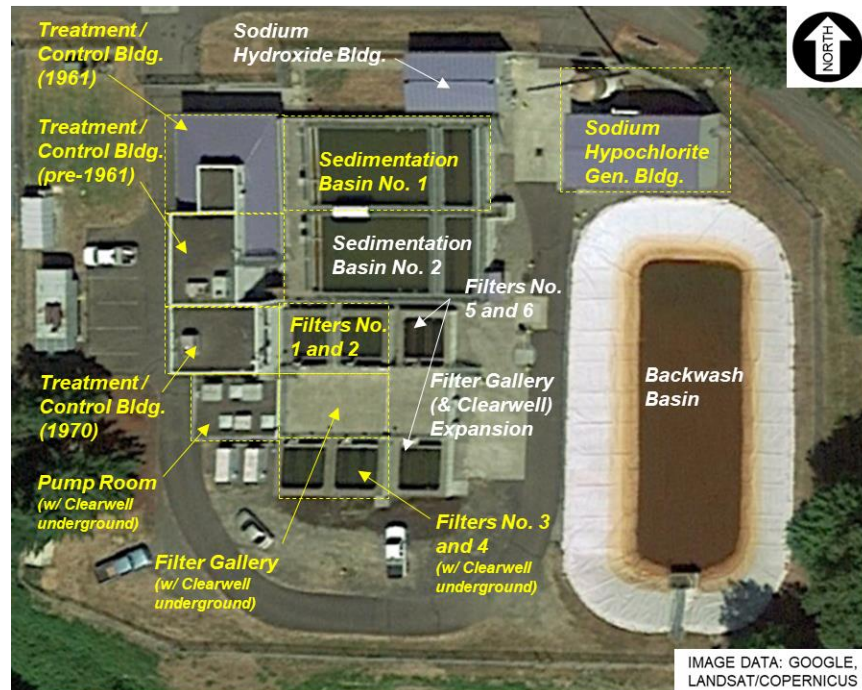


Figure 3.13 – Newberg Water Treatment Plant Location Map

3.4.1 Original Treatment/Control Building (pre-1961)

The Treatment/Control Building was originally constructed prior to 1961 and is located on the west side of the treatment plant. The Original Treatment/Control Building (pre-1961), is shown in Figure 3.14. The building is a two-story reinforced concrete shear wall building with reinforced concrete floor and roof diaphragms.

In 1961, an addition was constructed on the north side of the Original Treatment/Control Building (pre-1961). In 1970, a second addition was constructed, this time on the south side of the Original Treatment/Control Building (pre-1961). Both additions were constructed to be seismically independent of the Original Treatment/Control Building (pre-1961), however the joint width was specified to be $\frac{3}{4}$ inch or less.

Currently the ground level of the Original Treatment/Control Building (pre-1961) is used to house the polymer feed system, a pipe gallery for the raw water pipeline feeding Sedimentation Basin No. 2, and miscellaneous storage. The second level contains electrical equipment and motor control centers for the majority of the plant.

Structural drawings were not available for the Original Treatment/Control Building and development of as-built drawings was beyond the scope of this study. Potential structural deficiencies identified by this assessment have been based on field observations and general knowledge of typical construction practices during the era of original construction. Table 3.4 provides a summary of potential seismic structural and nonstructural deficiencies identified by this evaluation. Based on the potential deficiencies identified in Table 3.4, the Original Treatment/Control Building (pre-1961) is not currently expected to achieve Immediate Occupancy structural performance or Operational nonstructural performance for a M9.0 CSZ earthquake. Additionally, based on the potential deficiencies identified in this assessment, the Original Treatment/Control Building (pre-1961) is not currently expected to achieve Life Safety performance and represents a safety hazard to City staff and contractors.

Table 3.4 – Original Treatment/Control Building (pre-1961) Seismic Evaluation Summary

Potential Deficiencies	Description
Structural	<ul style="list-style-type: none"> • Per Shannon & Wilson Report, significant permanent ground deformation (PGD) is anticipated near the WTP: 0.5-1.5 inches liquefaction induced settlement, approximately 16 inches liquefaction-induced lateral spreading near slope 120 feet from plant, approximately 20 feet earthquake-induced landslide PGD near slope 120 feet from plant. This level of PGD could potentially cause structural damage to WTP buildings and process units and also damage associated buried piping. Additional geotechnical and structural assessment is recommended to more accurately characterize the level of PGD anticipated to occur at the WTP and evaluate the ability of structures and buried pipelines to accommodate this level of PGD. • A large L-shaped diaphragm opening (stairs) is located at the northwest corner of the building adjacent to both the north and west shear walls. This opening significantly reduces the ability of the diaphragm to transfer seismic forces to the walls. See Figure 3.15. • Concrete columns are not likely to satisfy deformation compatibility requirements due to inadequate tie spacing. • It is likely that the diaphragm to shear wall connection does not have adequate capacity to develop the lesser of the shear strength of the walls or diaphragms. • Several potential deficiencies are likely that are associated with detailing requirements for reinforcing steel (reinforcing ratio, foundation dowels, and wall and diaphragm reinforcing at openings). • The width of the seismic joints between the Original Treatment/Control Building, and the 1961 and 1970 Additions are not adequate to prevent potential pounding between these adjacent structures. See Figure 3.16.

Table 3.4 – Original Treatment/Control Building (pre-1961) Seismic Evaluation Summary (cont.)

Potential Deficiencies	Description
<p>Nonstructural</p>	<ul style="list-style-type: none"> • Pipes that penetrate concrete walls do not have adequate flexibility through the wall to accommodate the relative movement between the wall and the pipes. See Figure 3.17. • The raw water piping and valves are not adequately seismically braced. See Figure 3.18. • Vertical pipes are not adequately braced to the structure to resist seismic forces and do not have adequate flexibility to accommodate inter-story drift. See Figure 3.19. • Large chemical storage containers/drums are not restrained. See Figure 3.20. • Rolling carts are not restrained. See Figure 3.21. • A cabinet is improperly anchored to an electrical conduit with a U-bolt. See Figure 3.22. • Storage racks are not restrained. See Figure 3.23. • Mechanical ducts are unbraced. See Figure 3.24. • In-line fan unit is not braced in the direction parallel to the wall. See Figure 3.25. • It is unknown if adequate dowels are provided between the electrical cabinet housekeeping pads and floor slab. • Large diameter electrical conduits are not braced and flexible connections are not provided between the conduit and the top of the electrical cabinets. See Figure 3.26. • At least one of the electrical cabinets appears to be missing anchors at the base of the cabinet. See Figure 3.27. • Vertical cast iron roof drain in Electrical Room is not braced to structure and does not have adequate flexibility to accommodate inter-story drift. Potential failure could cause water intrusion and consequent damage to electrical equipment. See Figure 3.28. • Lights on pendant supports are not braced and may potentially swing and cause damage to other components. Some light fixtures do not include lens covers to prevent the light tubes from falling. See Figure 3.29. • Refrigerator and filing cabinets adjacent to walkway are not restrained. See Figure 3.30.

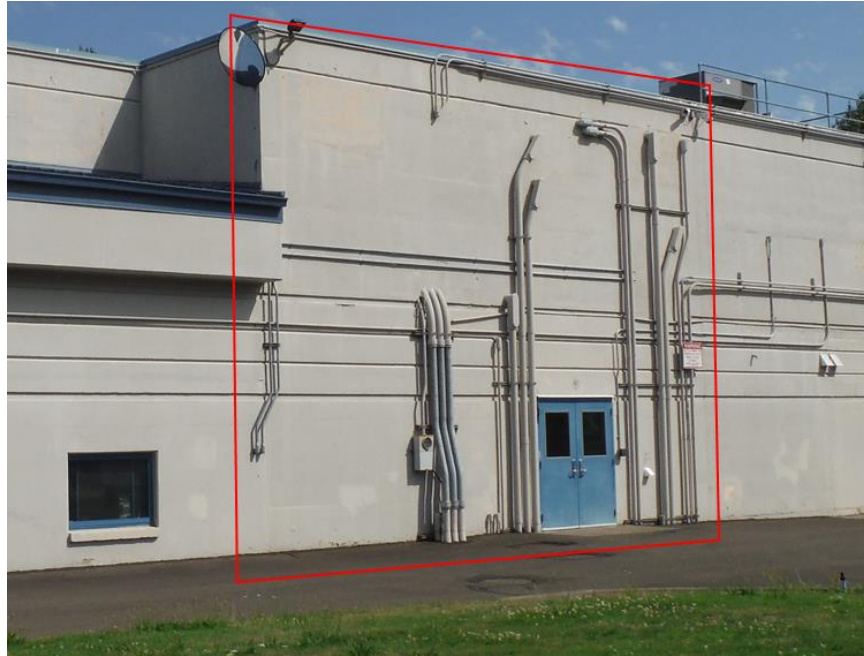


Figure 3.14 – Original Treatment/Control Building (pre-1961)

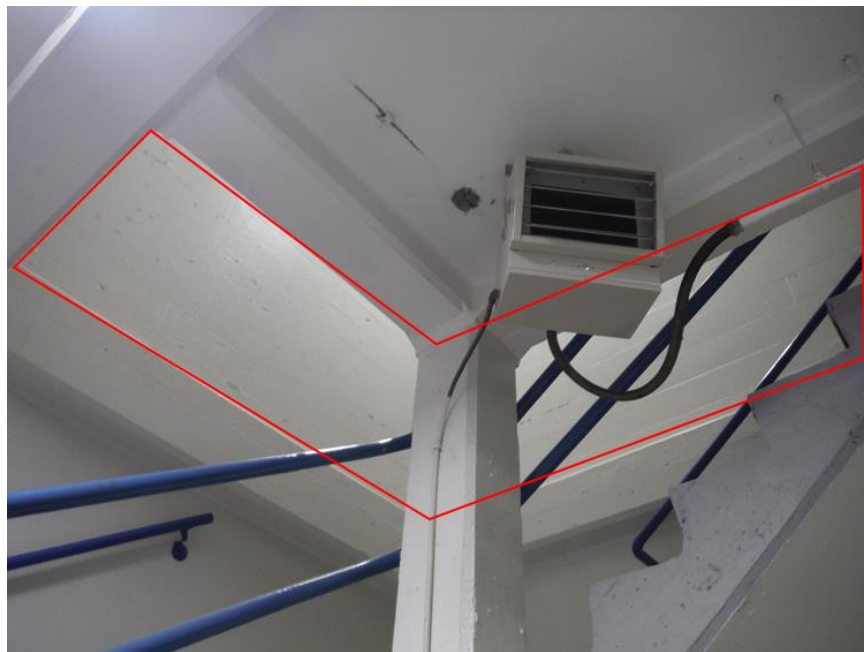


Figure 3.15 – Large Diaphragm Opening Adjacent to Shear Walls



Figure 3.16 – Seismic Joint Between Original Treatment/Control Building (pre-1961) and 1961 Addition



Figure 3.17 – Concrete Wall Penetration by Raw Water Pipe



Figure 3.18 – Raw Water Piping System without Adequate Bracing



Figure 3.19 – Vertical Pipe without Lateral Restraint



Figure 3.20 – Unrestrained Chemical Storage Containers



Figure 3.21 – Unrestrained Rolling Carts



Figure 3.22 – Storage Cabinet Restrained with U-Bolt to Electrical Conduits



Figure 3.23 – Unrestrained Storage Rack



Figure 3.24 – Mechanical Ducts not Braced to Structure



Figure 3.25 – In-Line Fan Unit Unrestrained to Movement Parallel to Wall



Figure 3.26 – Electrical Conduits not Seismically Braced and without Flexible Connections to Cabinets



Figure 3.27 – Electrical Cabinets with Missing Anchor at the Base



Figure 3.28 – Unbraced Cast Iron (Brittle) Vertical Pipe next to Electrical Cabinet



Figure 3.29 – Lights on Pendant Supports not Restrained and without Lens Covers



Figure 3.30 – Unrestrained Refrigerator and Filing Cabinets Adjacent to Walkway

3.4.2 1961 Treatment/Control Building Addition

In 1961, a Treatment/Control Building Addition was constructed on the north side of the Original Treatment/Control Building and west of Sedimentation Basin No. 1 (see Figure 3.31). The 1961 Treatment/Control Building Addition is a two-story reinforced concrete shear wall structure with reinforced concrete floor and roof diaphragms. The lower level of the structure is partially buried and supports abandoned coke beds (formerly used as part of the treatment process).

This 1961 Addition was constructed on the north side of the Original Treatment/Control Building (pre-1961). The addition was constructed to be seismically independent of the Original Treatment/Control Building (pre-1961), however the joint width was specified to be $\frac{3}{4}$ inch or less.

Currently the 1961 Treatment/Control Building Addition is used as a storage room/shop on the ground level, and an office area on the second floor.

Table 3.5 provides a summary of potential seismic structural and nonstructural deficiencies identified by this evaluation. Based on the potential deficiencies identified in Table 3.5, the 1961 Treatment/Control Building Addition is not currently expected to achieve Immediate Occupancy structural performance or Operational nonstructural performance for a M9.0 CSZ earthquake. Additionally, based on the potential deficiencies identified in this assessment, the 1961 Treatment/Control Building Addition is not currently expected to achieve Life Safety performance and represents a safety hazard to City staff and contractors.

Table 3.5 – 1961 Treatment/Control Building Addition Seismic Evaluation Summary

Potential Deficiencies	Description
Structural	<ul style="list-style-type: none"> • Permanent ground deformation – see first bullet of Table 3.4. • Second story concrete shear walls are not continuous to the foundation. See Figure 3.32 • Concrete columns do not satisfy deformation compatibility requirements due to inadequate tie spacing. • There is only one shear wall line in the east-west direction that is continuous to the foundation (Figure 3.32) resulting in deficient load path, lack of redundancy, potential torsional issues, and lack of adequate diaphragm chords. • The second floor level is comprised of a split-level diaphragm. See Figure 3.32. • The width of the seismic joint between the Original Treatment/Control Building and the 1961 Addition is not adequate to prevent potential pounding between these adjacent structures.
Nonstructural	<ul style="list-style-type: none"> • Storage racks and shelves are not anchored or braced. See Figure 3.33. • Heavy contents (porta-torch gas cylinders and small air compressor) are stored on top shelves (more than 4 feet above floor level) without restraint. See Figure 3.34. • Computer equipment is unrestrained. See Figure 3.35.



Figure 3.31 – 1961 Treatment/Control Building Addition

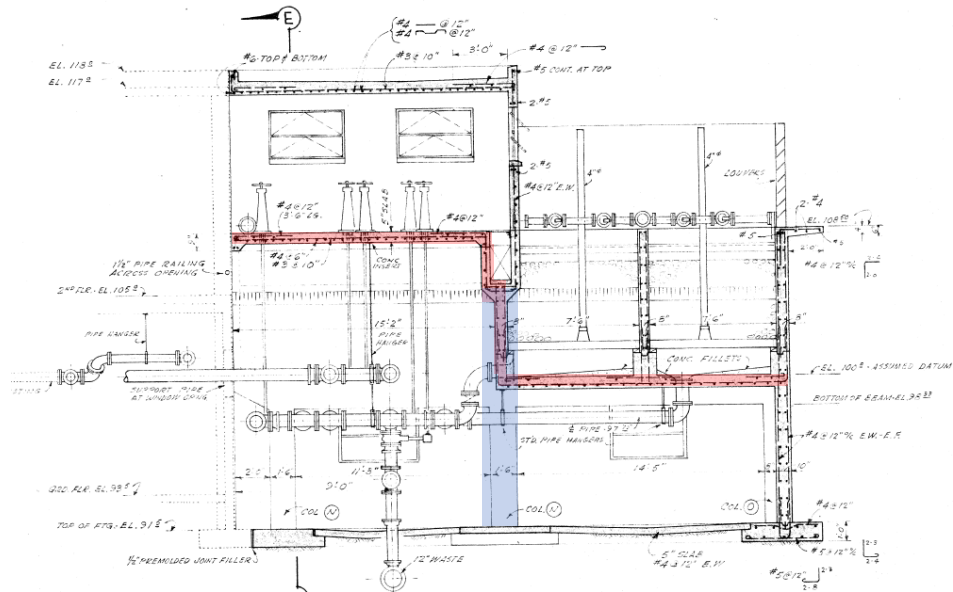


Figure 3.32 – Shear Wall not Continuous to Foundation (Blue Shaded) and with Split Level Diaphragms (Red Shaded)
(Source Drawings: “Water Treatment Plant Addition (A610001)”)

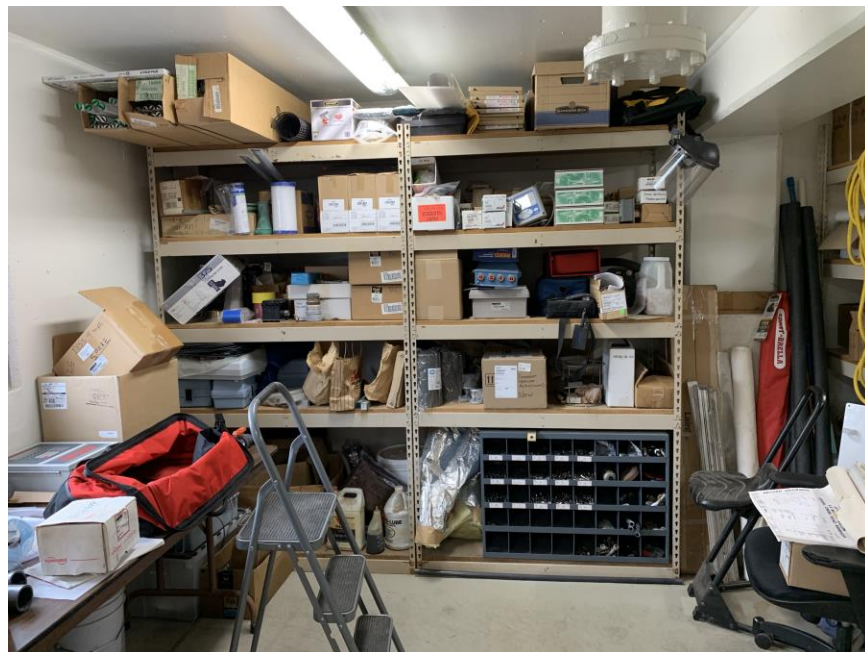


Figure 3.33 – Unrestrained Storage Rack

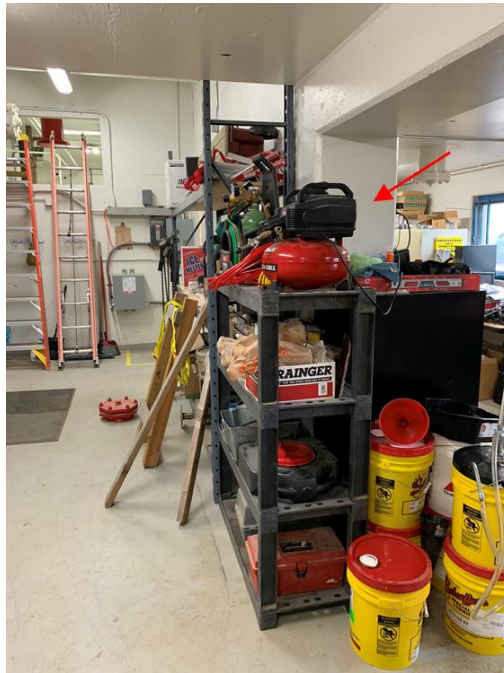


Figure 3.34 – Porta-Torch Gas Cylinders and Air compressor Stored on Top Shelf

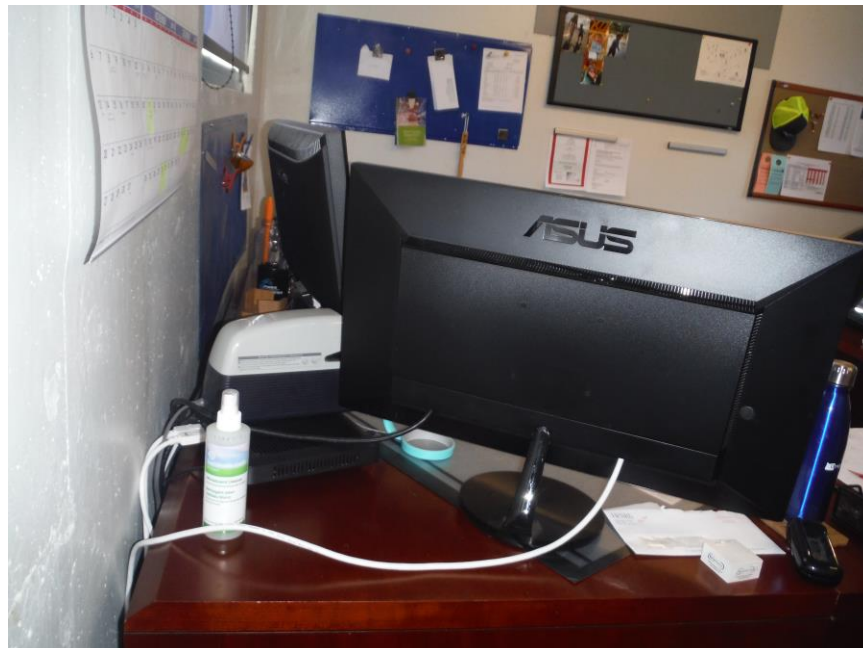


Figure 3.35 – Unrestrained Computer Equipment

3.4.3 1970 Treatment/Control Building Addition

In 1970, a Treatment/Control Building Addition was constructed on the south side of the Original Treatment/Control Building and west of Filters No. 1 and 2 (see Figure 3.36). The south wall of the 1970 Treatment/Control Building Addition is shared by the Pump Room, that was also constructed at the same time. The 1970 Treatment/Control Building Addition is a two-story reinforced concrete shear wall structure with a reinforced concrete diaphragm at the second floor level and a wood (straight-sheathed) roof diaphragm.

This 1970 Addition was constructed on the south side of the Original Treatment/Control Building (pre-1961). The addition was constructed to be seismically independent of the Original Treatment/Control Building (pre-1961), however the joint width was specified to be $\frac{3}{4}$ inch or less.

Currently the 1970 Treatment/Control Building Addition contains restrooms, and a hallway at the ground level and plant control room, office and laboratory spaces on the second floor.

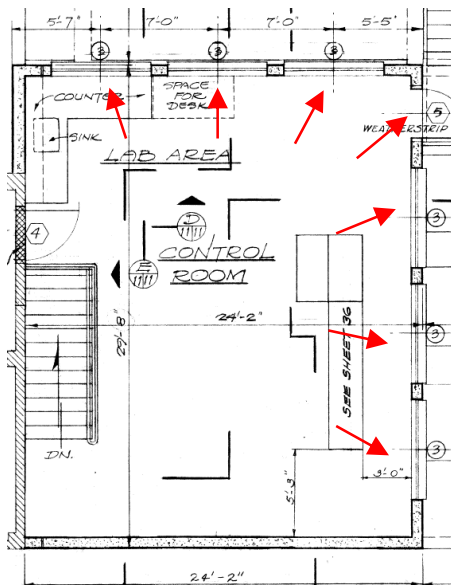
Table 3.6 provides a summary of potential seismic structural and nonstructural deficiencies identified by this evaluation. Based on the potential deficiencies identified in Table 3.6, the 1970 Treatment/Building Addition is not currently expected to achieve Immediate Occupancy structural performance or Operational nonstructural performance for a M9.0 CSZ earthquake. Additionally, based on the potential deficiencies identified in this assessment, the 1970 Treatment/Control Building Addition is not currently expected to achieve Life Safety performance and represents a safety hazard to City staff and contractors.

Table 3.6 – 1970 Treatment/Control Building Addition Seismic Evaluation Summary

Potential Deficiencies	Description
Structural	<ul style="list-style-type: none"> • Permanent ground deformation – see first bullet of Table 3.4. • Concrete columns do not satisfy deformation compatibility requirements due to inadequate tie spacing. • There is only one shear wall line in the east-west direction, resulting in a deficient load path, lack of redundancy, potential torsional issues, and lack of adequate diaphragm chords. • Between the second floor and the roof there is a significant reduction in the cross-sectional area of the south and east shear walls due to the existing windows and door. See Figure 3.37. • The roof diaphragm lacks adequate cross ties between flexible diaphragm chords. See Figures 3.38. • In the north-south direction (perpendicular to glulam members) there does not appear to be an adequate load path to transfer seismic forces from the roof diaphragm to the concrete shear walls. See Figure 3.39. • The roof diaphragm is not attached to the concrete shear walls with connections that are adequate to resist the expected out-of-plane forces. Additionally, the ledgers that supports the roof straight sheathing on the north and south sides of the buildings are potentially subjected to cross grain bending when resisting wall out-of-plane anchorage forces. See Figure 3.40. • The width of the seismic joint between the Original Treatment/Control Building and the 1970 Addition is not adequate to prevent potential pounding between these adjacent structures.
Nonstructural	<ul style="list-style-type: none"> • The CMU partition walls around the restrooms are constructed tight to the adjacent concrete beams and walls without an adequate separation to prevent them from unintentionally participating in resisting seismic loads. See Figure 3.41. • Computer equipment is unrestrained. See Figure 3.42. • Several pieces of equipment on the lab counter are unrestrained. See Figure 3.43. • Chemical cabinets doors are not properly latched to prevent accidental opening during an earthquake. See Figure 3.44. • Water heater is not adequately restrained. See Figure 3.45. • Light fixtures are supported by the ceiling grid and lack proper independent support. See Figure 3.46. • The suspended ceiling system is not adequately braced to the structure. See Figure 3.46.



Figure 3.36 – 1970 Treatment/Control Building Addition



(a) Architectural Plan View of Control Room
 (Source Drawings: “Water Treatment Plant (A700004)”)

(b) Outside View of Control Room East and South Walls

Figure 3.37 – Reduction of Shear Walls Cross Section Due to Presence of Windows and Door



Figure 3.38 – Flexible Diaphragm Chords without Cross Ties



Figure 3.39 – Joist to Perpendicular Wall Connection

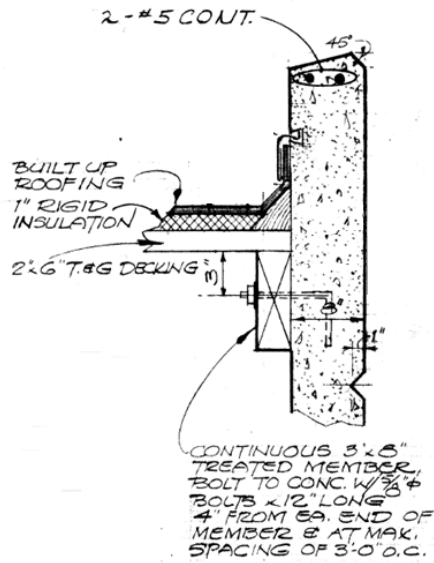
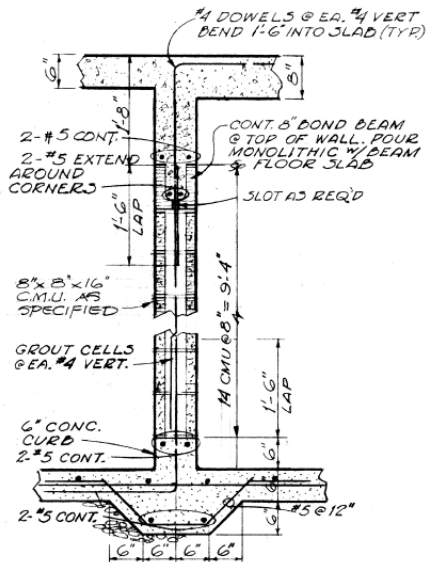
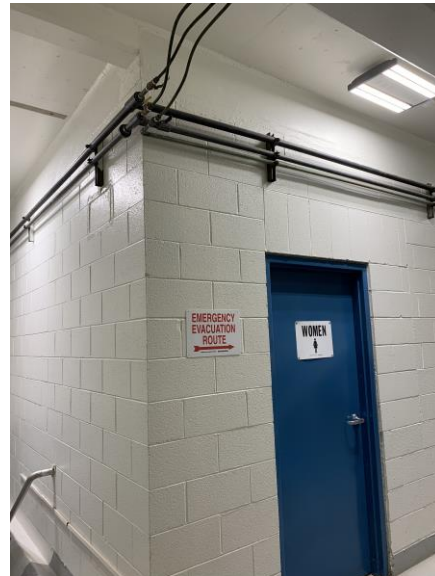


Figure 3.40 – Detail of Joist to Adjacent Wall Connection
 (Source Drawings: “Water Treatment Plant (A700004)”)



(a) Detail of CMU Wall to RC Beam Connection
 (Source Drawings: “Water Treatment Plant (A700004)”)



(b) CMU Wall Partitions

Figure 3.41 – CMU Wall Partitions not Isolated from Structure



Figure 3.42 – Unrestrained Computer Equipment



Figure 3.43 – Unrestrained Equipment on Lab Counter



Figure 3.44 – Chemical Cabinet Doors without Proper Latches



Figure 3.45 – Water Heater Tank not Adequately Restrained



Figure 3.46 – Light Fixture Supported by Ceiling Grid

3.4.4 Sedimentation Basin No. 1

Sedimentation Basin No.1, shown in Figure 3.47, was built in 1961 and is located north of Sedimentation Basin No.2. Sedimentation Basin No.1 has reinforced concrete shear walls around the perimeter. The center wall between Sedimentation Basin No. 1 and 2 is shared by both basins. In the basin, there are a wood baffle near the west end to still the flow into the basin and three steel weirs crossing the basin in the north-south direction near the east end to convey water to the collector trough.

Sedimentation Basin No. 1 was constructed around 1970 on the north side of Sedimentation Basin No. 2 (pre-1961). The addition was constructed to be seismically independent of the Original Treatment/Control Building (pre-1961), however the joint width was specified to be ½ inch.

Structural drawings were not available for Sedimentation Basin No. 2 (i.e. the structure that forms the south wall of Sedimentation Basin No. 1) and development of as-built drawings was beyond the scope of this study. Potential structural deficiencies identified by this assessment have been based on field observations and general knowledge of typical construction practices during the era of original construction. Table 3.7 provides a summary of potential seismic structural and nonstructural deficiencies identified by this evaluation. Based on the potential deficiencies identified in Table 3.7, Sedimentation Basin No.1 is not currently expected to achieve Immediate Occupancy structural performance or Operational nonstructural performance for a M9.0 CSZ earthquake.

Table 3.7– Sedimentation Basin No. 1 Evaluation Summary

Potential Deficiencies	Description
Structural	<ul style="list-style-type: none"> • Permanent ground deformation – see first bullet of Table 3.4. • The width of the seismic joint between Sedimentation Basins No. 1 and 2 is not adequate to prevent potential pounding between these adjacent structures. See Figure 3.48. • Insufficient freeboard (approximately 7 in) to accommodate sloshing waves, which may potentially overtop the basin and enter the Sodium Hydroxide Building through air vents in the south wall of the building. See Figure 3.49. • Seismic joints were detailed to include a copper water stop, but potential water leaks may occur due to relative movement between Sedimentation Basins No. 1 and 2, and the effluent structure (built in 1970). See Figure 3.50. • The Basin perimeter walls are potentially overstressed by earthquake-induced hydrodynamic forces and will likely be damaged during an earthquake.
Nonstructural	<ul style="list-style-type: none"> • Wooden baffles may not have adequate strength to resist hydrodynamic forces. See Figure 3.51. • Small diameter anchors used to connect the weir troughs to the basin walls may not be adequate to resist hydrodynamic forces. See Figure 3.52. • Pipes that penetrate concrete walls may not have adequate flexibility to accommodate the relative movement between the wall and the pipes. See Figure 3.53.



Figure 3.47 – Sedimentation Basin No. 1 Structure



Figure 3.48 – Construction Joint Between Sedimentation Basins No. 1 (1961 Construction) and No. 2 (pre-1961 Construction)

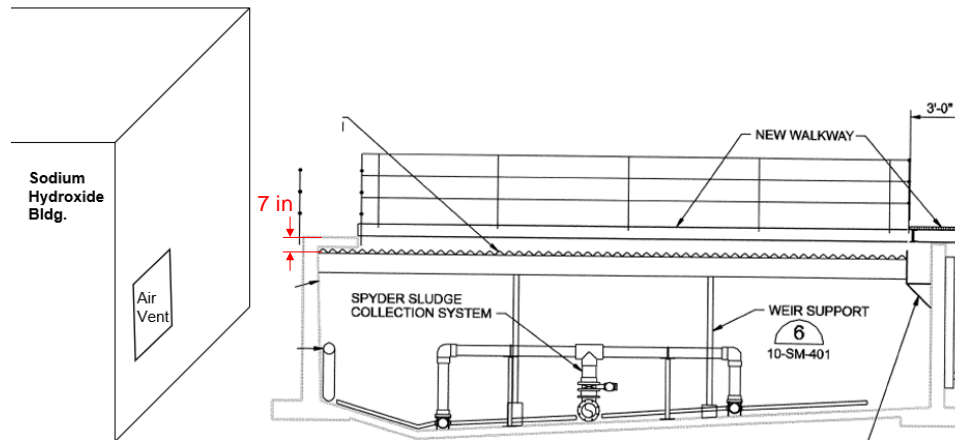


Figure 3.49 – Insufficient Freeboard (~7 in) to Accommodate Sloshing Waves in Sedimentation Basin Near Sodium Hydroxide Building



Figure 3.50 – Sedimentation Basins Effluent Structure (Outlet Basin Structure)

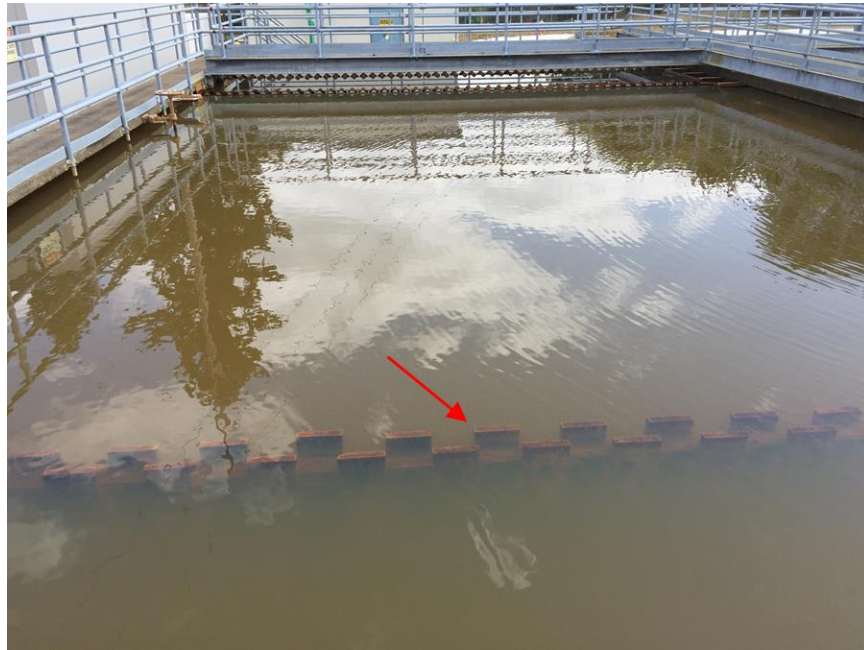


Figure 3.51 – Wooden Baffles in Sedimentation Basin No. 1



Figure 3.52 – Weir Trough to Basin Structure Connection Using Small Diameter Anchors



Figure 3.53 – Raw Water Pipes Penetrating Concrete Wall without Adequate Flexibility Through Wall

3.4.5 Filters No.1 to 4, Filter Gallery, Pump Room, and Associated Clearwell

Filters No.1 and 2, the Filter Gallery, the Pump Room, and the associated Clearwell were constructed in 1970. Filters No. 3 and 4 were added in 1980. Figure 3.54 shows the Filters No. 1 to 4 and the concrete roof slab over the Filter Gallery. Figure 3.55 shows the exterior of the partially buried Pump Room. Filters No. 1 and 2 are located east of the 1970 Treatment/Control Building Addition and south of Sedimentation Basin No. 2. The Filter Gallery is located south of Filters No.1 and 2 and north of Filters No. 3 and 4.

The Filters have reinforced concrete shear walls around their perimeter and reinforced concrete (Filters No. 1 and 2) or steel (Filters No. 3 and 4) wash troughs crossing the filters in the east-west direction. The Filter Gallery and Pump Room are located above the Clearwell and form a two-story reinforced concrete shear wall structure with reinforced concrete diaphragms, except at the Pump Room roof that consists of a wood (straight-sheathed) diaphragm. The Clearwell that was built in 1970 also extends under Filters No. 3 and 4 (which were considered as a future expansion during the 1970 design and construction).

In 2005, the Filter Gallery was extended towards the east, and two new filters (Filters No. 5 and 6) and a Clearwell expansion were constructed approximately 3 ft. east of the existing filters. At the Filter Gallery roof level, the slab for the Filter Gallery expansion extends towards the west to within 1 inch of the roof slab from the original Filter Gallery (1970 construction). Within the Filter Gallery, a short walkway section was added between the original Filter Gallery (1970 construction) and expansion Filter Gallery. A small expansion joint is provided between the walkway and original Filter Gallery. A single short section of 24-inch diameter pipe hydraulically connects the expansion Clearwell to the original Clearwell (1970 construction).

Table 3.8 provides a summary of potential seismic structural and nonstructural deficiencies identified by this evaluation. Based on the potential deficiencies identified in Table 3.8, the Filters No.1 to 4, Filter Gallery, Pump Room, and associated Clearwell structure is not currently expected to achieve Immediate Occupancy structural performance or Operational nonstructural performance for a M9.0 CSZ earthquake. Additionally, based on the potential deficiencies identified in this assessment, the Filters No.1 to 4, Filter Gallery, Pump Room, and associated Clearwell structure is not currently expected to achieve Life Safety performance and represents a safety hazard to City staff and contractors.

Table 3.8 – Filters No. 1 to 4, Filter Gallery, Pump Room, and Associated Clearwell Structure Seismic Evaluation Summary

Potential Deficiencies	Description
<p>Structural</p>	<ul style="list-style-type: none"> • Permanent ground deformation – see first bullet of Table 3.4. <p><u>Filter Gallery and Clearwell</u></p> <ul style="list-style-type: none"> • The south shear wall of the Filter Gallery is not continuous to the foundation. It is supported by concrete columns within the Clearwell. See Figure 3.56. • Clearwell concrete columns do not satisfy deformation compatibility requirements due to inadequate tie spacing. • The diaphragm to shear wall connection does not have adequate capacity to develop the lesser of the shear strength of the walls or diaphragms. • The width of the roof slab and walkway seismic joint between Filters No. 2 and 4, and Filters No. 5 and 6 is not adequate to prevent potential pounding between these adjacent structures. See Figure 3.57. • The width of the walkway slab seismic joint between Filters No. 1 and 2, and Sedimentation Basin No. 2 is not adequate to prevent potential pounding between these adjacent structures. <p><u>Pump Room</u></p> <ul style="list-style-type: none"> • The Pump Room is not seismically separated from the 1970 Treatment/Control Building Addition, but these structures are of different heights and their floor/roof levels are not aligned. See Figure 3.58. These split-level diaphragms impose seismic forces in the out-of-plane direction at mid-height of the shared wall. This configuration is not desirable for a structure intended to provide Immediate Occupancy structural performance after a major earthquake. • The roof diaphragm lacks adequate cross ties between flexible diaphragm chords. See Figure 3.59. • In the east-west direction (perpendicular to glulam members) there does not appear to be an adequate load path to transfer seismic forces from the roof diaphragm to the north concrete shear wall. See Figure 3.60. • The roof diaphragm is not attached to the concrete shear walls with connections that are adequate to resist the expected out-of-plane forces.

Table 3.8 – Filters No. 1 to 4, Filter Gallery, Pump Room, and Associated Clearwell Structure Seismic Evaluation Summary (cont.)

Potential Deficiencies	Description
<p>Structural (cont.)</p>	<p><u>Filters</u></p> <ul style="list-style-type: none"> The Filters are not seismically separated from the 1970 Treatment/Control Building Addition, but these structures are of different heights and their floor/roof levels are not aligned. See Figure 3.61. These split-level diaphragms impose seismic forces in the out-of-plane direction at mid-height of the shared wall. This configuration is not desirable for a structure intended to provide Immediate Occupancy structural performance after a major earthquake.
<p>Nonstructural</p>	<p><u>Filter Gallery</u></p> <ul style="list-style-type: none"> The finished water, filter backwash, sodium hydroxide, and air scour pipes that cross the seismic joint between the 1970 Filter Gallery and 2005 Filter Gallery Addition do not appear to have adequate flexibility to accommodate potential differential displacements between these adjacent structures. See Figures 3.62 and 3.63. The finished water, filter backwash, and air scour pipes are not adequately braced to the structure to resist seismic forces. See Figure 3.64. Valves and valve operators installed in-line with the finished water and backwash pipes are not independently braced (arrows in Figure 3.64). The air scour piping does not have adequate flexibility to accommodate potential relative movement between the blowers located in soundproofing enclosures outside the building and the Filter Gallery building. See Figure 3.65. The air vent valve and muffler are not adequately braced to the structure to resist seismic forces. See Figure 3.66. <p><u>Pump Room</u></p> <ul style="list-style-type: none"> The vertical air relief pipe is not adequately braced to the structure to resist seismic forces. See Figure 3.67. Pump motors are not braced to the structure above their center of gravity. See Figure 3.68. Flexible connections are not used between pump casing and piping to accommodate potential differential movement. See Figure 3.68. The electrical transformer is not adequately braced to prevent movement parallel to the wall. See Figure 3.69. Anchorage between rooftop HVAC units and roof curbs is potentially inadequate.

Table 3.8 – Filters No. 1 to 4, Filter Gallery, Pump Room, and Associated Clearwell Structure Seismic Evaluation Summary (cont.)

Potential Deficiencies	Description
Nonstructural (cont.)	<u>Filters</u> <ul style="list-style-type: none">Valve operators are not adequately anchored to the Filter structure to resist seismic forces. They are bolted to slotted base plates that appear to have been significantly modified. See Figure 3.70.



Figure 3.54 – Filters No. 1 to 4 and Filter Gallery Roof Slab

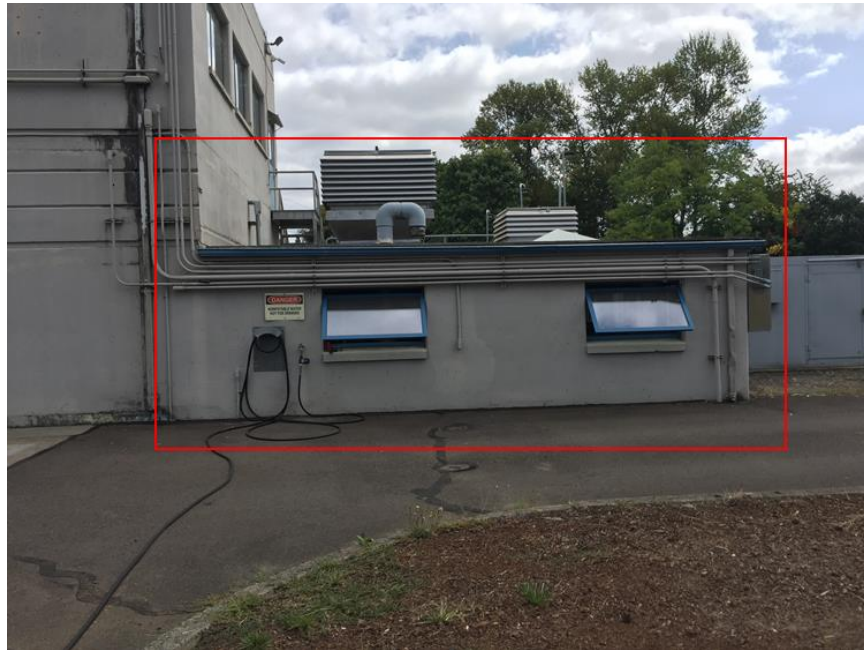


Figure 3.55 – Pump Room

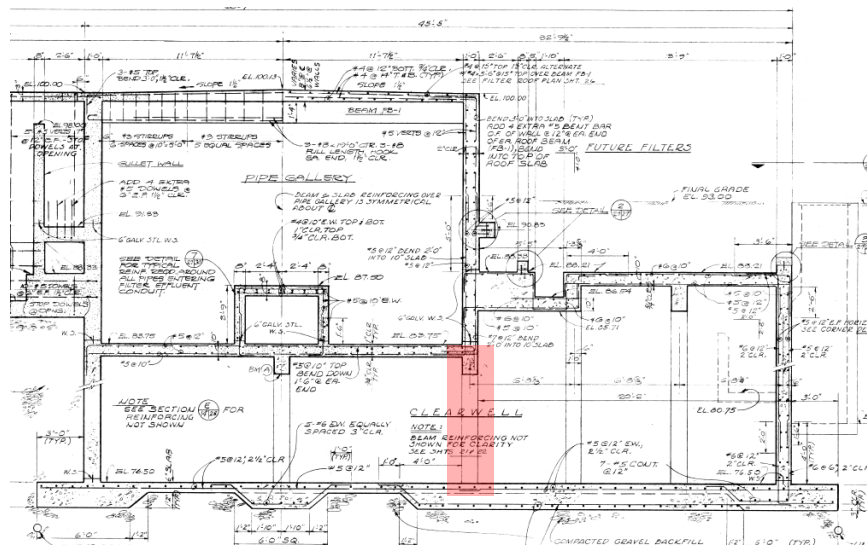


Figure 3.56 – Shear Wall not Continuous to Foundation
 (Source Drawings: “Water Treatment Plant (A700004)”)

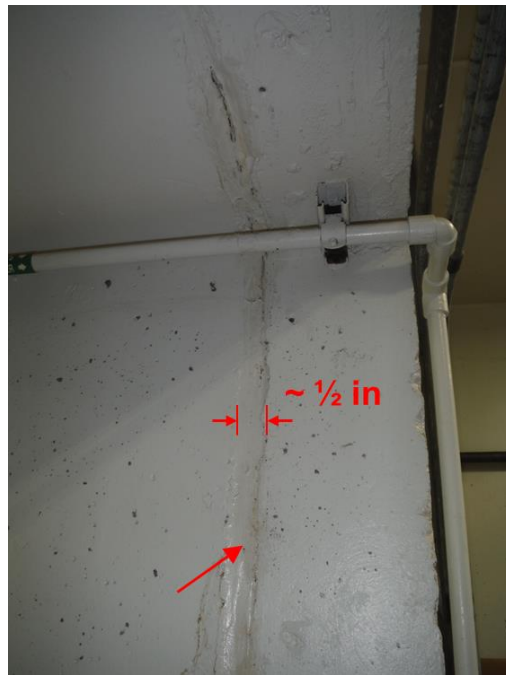
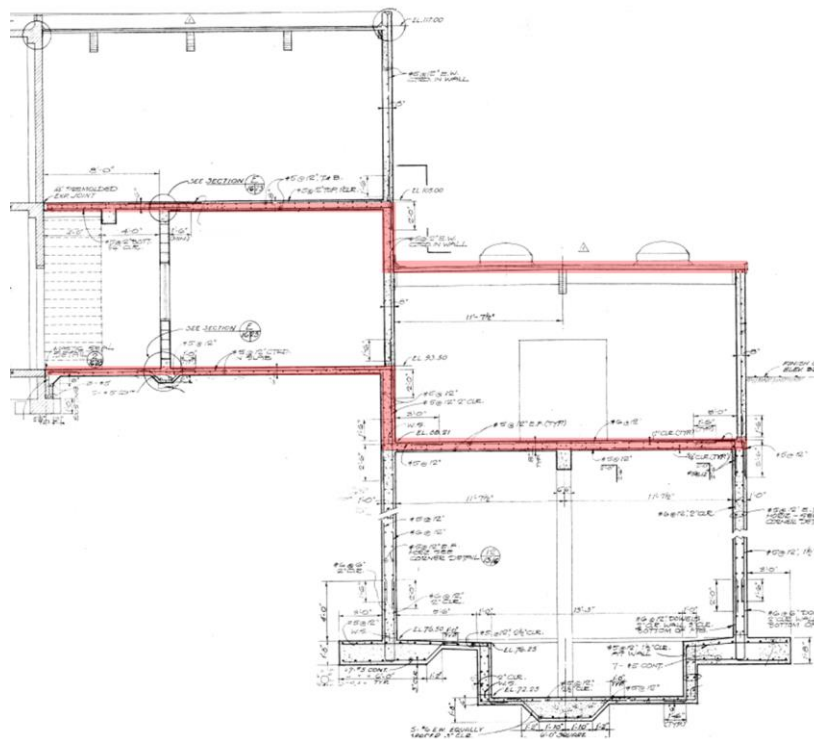


Figure 3.57 – Filter Gallery Seismic Joint (Between 1970 Construction and 2005 Expansion)



**Figure 3.58 – Split Level Diaphragms
(Source Drawings: “Water Treatment Plant(A700004)”)**



Figure 3.59 – Flexible Diaphragm without Cross Ties



Figure 3.60 – Joist to Perpendicular Wall Connection

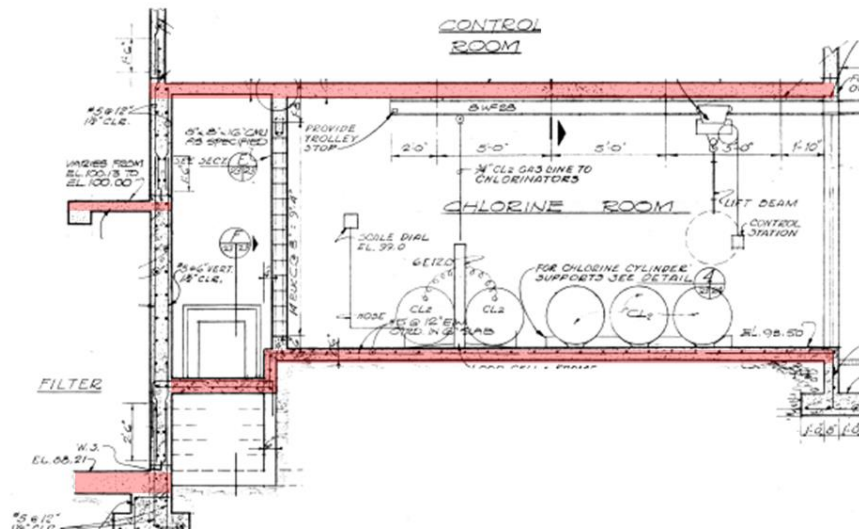


Figure 3.61 – Control/Treatment Building (1970) and Filter Floor/Roof Levels not Aligned (Source Drawings: “Water Treatment Plant (A700004)”)



Figure 3.62 – Finished Water Sample Pipe and Filter Backwash Pipe Cross Seismic Joint without Adequate Flexibility

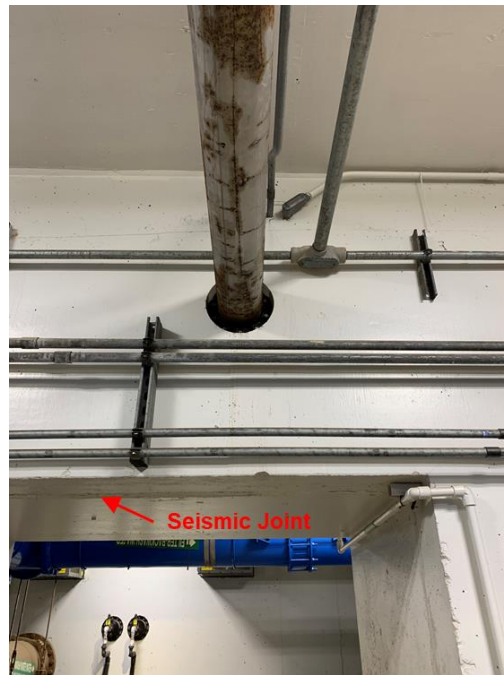


Figure 3.63 – Air Scour Pipe Crosses Seismic Joint without Adequate Flexibility



Figure 3.64 – Valves and Valve Actuators Installed In-Line with Piping Systems not Independently Braced



Figure 3.65 – Air Scour Piping from Blowers to Filter Gallery without Adequate Flexibility to Accommodate Differential Movement



Figure 3.66 – Air Vent Valve and Muffler not Adequately Braced



Figure 3.67 – Air Relief Piping Penetrating Laterally Unrestrained



Figure 3.68 – Pump Motors not Braced to Structure Above their Center of Gravity



Figure 3.69 – Electrical Transformer not Adequately Braced Against Movement Parallel to Wall



Figure 3.70 – Valve Actuators Installed on Significantly Modified Base Plates

3.4.6 Sodium Hypochlorite Generation Building

The Sodium Hypochlorite Generation Building is a steel frame metal building system constructed in 2005 (see Figure 3.71). The building is located at the northeast corner of the plant site. Immediately north of the building, there is a tank storing salt brine solution (NaCl) that is used in the generation of sodium hypochlorite.

The Sodium Hypochlorite Generation Building metal building system consists of steel moment resisting frames in the north-south direction and steel braced frames in the east-west direction (see Figure 3.72) and has a bare metal deck and tension rod flexible roof diaphragm.

Structural drawings were not available for the Sodium Hypochlorite Generation Building and development of as-built drawings was beyond the scope of this study. Potential structural deficiencies identified by this assessment have been based on field observations and general knowledge of typical construction practices. Table 3.9 provides a summary of potential seismic structural and nonstructural deficiencies identified by this evaluation. Based on the potential deficiencies identified in Table 3.9, the Sodium Hypochlorite Generation Building is not currently expected to achieve Immediate Occupancy structural performance or Operational nonstructural performance for a M9.0 CSZ earthquake.

Table 3.9 – Sodium Hypochlorite Generation Building Seismic Evaluation Summary

Potential Deficiencies	Description
<p>Structural</p>	<ul style="list-style-type: none"> • Permanent ground deformation – see first bullet of Table 3.4. • The lateral force resisting system lacks redundancy in both directions since there is only one lateral force resisting bay per frame line. See Figures 3.73 and 3.74. • The load path to transfer seismic forces from the roof diaphragm to the moment frame beam is not adequate since there is no blocking provided between purlins. See Figure 3.75. • The load path to transfer seismic forces from the roof diaphragm to the braced frame tension rod bracing involves indirect force transfer from the roof diaphragm to the purlins and then out-of-plane bending of the moment frame beam to column connection to transfer forces to the tension rod bracing. This indirect load path is not desirable for a building with an Immediate Occupancy structural performance objective. See Figure 3.76. • Steel beams and columns likely do not meet section compactness requirements for highly ductile member.

Table 3.9 – Sodium Hypochlorite Generation Building Seismic Evaluation Summary (cont.)

Potential Deficiencies	Description
<p>Structural (cont.)</p>	<ul style="list-style-type: none"> • It is likely that the moment resisting connections do not have adequate capacity to develop the expected strength of the adjoining beam and column members and panel zones may not have adequate capacity to resist expected shear force demands. See Figure 3.77. • Purlin splices may not have adequate capacity to resist cross tie forces. See Figure 3.78. • Grout layer is not provided under column base plates and nuts on anchor rod are not tight. See Figure 3.79.
<p>Nonstructural</p>	<ul style="list-style-type: none"> • Pipes from the exterior salt brine tank into process equipment inside the building do not have adequate flexibility to accommodate the expected relative movement between the tank and building. See Figure 3.80. • Drain pipe from the exterior salt brine tank through the concrete slab does not have adequate flexibility to accommodate potential relative movement between tank and the slab. See Figure 3.81. • PVC Vent Piping is not braced to the structure either inside or outside the building. See Figure 3.82. • Pipes connecting the two sodium hypochlorite tanks do not have adequate flexibility to accommodate potential relative movement between the tanks. See Figure 3.83. • Piping connected to both the Sodium Hypochlorite Generation skid and the building does not have flexibility to accommodate the expected building movement. See Figure 3.84. • Anchorage of chemical feed pumps is potentially not adequate due to small diameter and missing anchors. See Figure 3.85. • Hot water heater is not adequately braced to the structure as it has only one strap restraining it instead of two. See Figure 3.86. • Storage barrel is not restrained. See Figure 3.86. • Water softener components are not restrained. See Figure 3.87. • Instant hot water heater is not adequately restrained (only restrained against movement in one direction). See Figure 3.88. • Control Panel is not adequately braced to the structure as it is attached only to the relatively flexible fiberglass handrail. See Figure 3.89. • Transformer on strut support is not adequately braced to the structure. See Figure 3.90. • Lights on pendant supports are not braced and may potentially swing and cause damage to other components. See Figure 3.91.



Figure 3.71 – Sodium Hypochlorite Generation Building

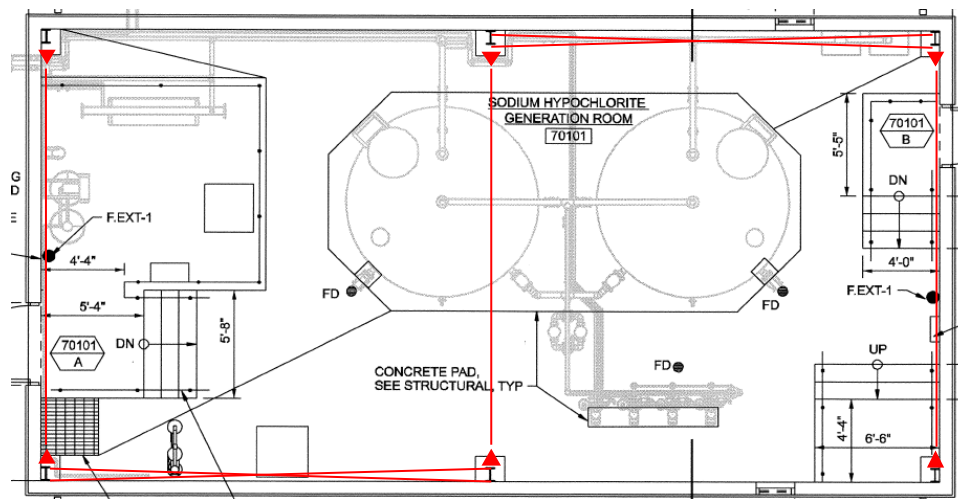
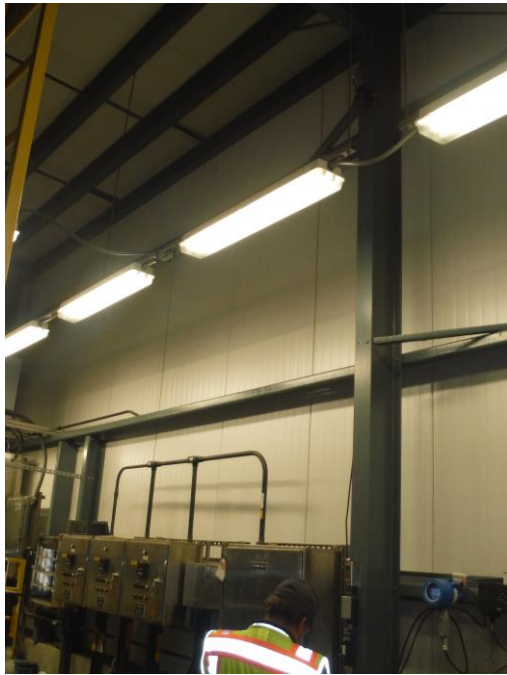


Figure 3.72 – Scheme of Building Lateral Force Resisting Systems
(Source Drawings: Water Treatment Plant Expansion to 9.5 MGD (A2007005))



(a) East Bay without Rod Bracing



(b) West Bay with Rod Bracing

Figure 3.73 – Single Lateral Force Resisting Bay in Frame Line along East-West Direction



Figure 3.74 – Single Lateral Force Resisting Bay in Frame Line along North-South Direction



Figure 3.75 – Inadequate Load Path from Roof Diaphragm to Moment Frame Beams (no Blocking between Purlins)

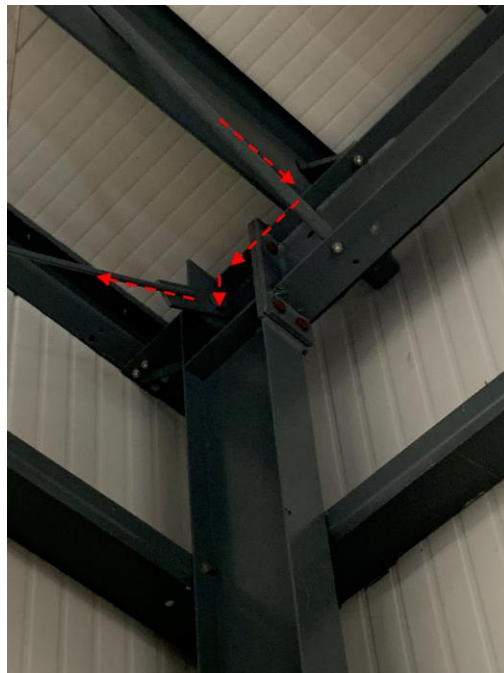


Figure 3.76 – Indirect Load Path from Diaphragm to Brace Frame



Figure 3.77 – View of Moment Frame Connection and Panel Zone

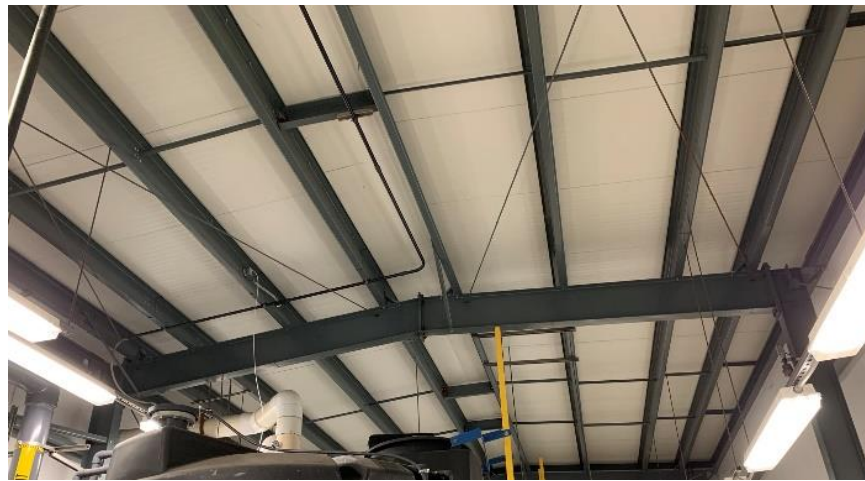


Figure 3.78 – Purlins Between Diaphragm Chords



Figure 3.79 – UngROUTed Base Plate and Nuts on Anchor Rods not Tight



Figure 3.80 – Piping Connecting Salt Brine Tank to Sodium Hypochlorite Generation Building without Adequate Flexibility



Figure 3.81 – Lack of Flexibility in Salt Brine Tank Drain Pipe



(a) Unbraced Piping Outside the Building



(b) Unbraced Piping Inside the Building

Figure 3.82 – Unbraced PVC Vent Piping



Figure 3.83 – Lack of Flexibility of Piping Connecting Sodium Hypochlorite Tanks



Figure 3.84 – Lack of Flexibility in Piping between Sodium Hypochlorite Generator and Attachment to Building



Figure 3.85 – Deficient Anchorage Between Chemical Feed Pumps and Concrete Support



Figure 3.86 – Water Heater not Adequately Restrained and Unrestrained Barrel



Figure 3.87 – Water Softener Components not Restrained



Figure 3.88 – Instant Hot Water Heater not Adequately Restrained



Figure 3.89 – Control Panel not Adequately Braced



Figure 3.90 – Transformer not Adequately Braced



Figure 3.91 – Unrestrained Light Fixtures

3.4.7 On-site Electrical Components

The seismic evaluation performed by SEFT also included consideration of the on-site electrical components that serve the water treatment plant (emergency generator, electrical switchgear and electrical transformer). These components are located west of the Treatment/Control Building and are shown in Figures 3.92 to 3.94. The emergency generator at the water treatment plant is a part of Portland General Electric’s (PGE’s) dispatchable generation program. PGE is responsible for performing routine maintenance and testing of the generator.

Table 3.10 provides a summary of potential seismic deficiencies identified by this evaluation. Based on the deficiencies identified in Table 3.10, the electrical components identified are not expected to support the Water Treatment Plant achieving Operational nonstructural performance following a M9.0 CSZ earthquake.

Table 3.10 – On-site Electrical Components Seismic Evaluation Summary

Potential Deficiencies	Description
Structural	<ul style="list-style-type: none"> • Permanent ground deformation – see first bullet of Table 3.4.
Nonstructural	<ul style="list-style-type: none"> • The stainless steel cabinet adjacent to the electrical switchgear is supported by both the original switchgear concrete pad and a concrete pad extension. This concrete pad extension may not be adequately attached to the original switchgear concrete pad and differential movement between the original pad and extension may damage the stainless steel cabinet. See Figure 3.93 • Electrical switchgear connection to the concrete pad appears to be missing an anchor and may not be adequate to resist the expected seismic loads. See Figure 3.95. • Electrical Transformer does not appear to be anchored to concrete pad. See Figure 3.96. • It is likely that starter batteries for the emergency generator are not adequately restrained.



Figure 3.92 – Emergency Generator



Figure 3.93 – Electrical Switchgear



Figure 3.94 – Electrical Transformer



Figure 3.95 – Missing Anchors on Switchgear to Concrete Pad Connection



Figure 3.96 – Electrical Transformer not Anchored to Concrete Pad

4.0 Next Steps

This report summarizes the results of SEFT’s seismic structural and nonstructural evaluation of three reservoirs (Corral Creek Road, North Valley No. 1 and North Valley No. 2), and selected components of the City of Newberg Water Treatment Plant [Original Treatment/Control Building (pre-1961), 1961 Treatment/Control Building Addition, 1970 Treatment/Control Building Addition, Sedimentation Basin No. 1, Filters No. 1 to 4, Filter Gallery, Pump Room, and Associated Clearwell Structure, and Sodium Hypochlorite Generation Building]. Based on the potential structural and nonstructural deficiencies observed, none of the evaluated structures are expected to achieve both the Immediate Occupancy structural performance objective and Operational nonstructural performance objective for a M9.0 CSZ scenario earthquake.

In order to continue to advance with City of Newberg water system resilience planning process, we recommend that a follow-up study be conducted that develops retrofit concepts for critical system components and includes consideration of dependency relationships required to sustain water system operation (diesel fuel for generator, salt for generation of sodium hypochlorite, etc.). The City of Newberg should also continue to evaluate and implement alternative options to provide water to customers in the event that the WTP and/or reservoirs are significantly damaged by a major earthquake and could take months to repair for more recently constructed structures to years to rebuild older structures. Additionally, for the safety of City staff and contractors, the City is strongly encouraged to implement a near-term seismic retrofit program to address Life Safety seismic deficiencies for the occupiable water system structures.

If an expansion of the plant is considered in the future to meet water production or operational goals, then there would be an opportunity to build more seismically resilient structures and associated support infrastructure that is capable of meeting the City’s post-earthquake LOS goals. The location and foundation design for any new water system structures should include appropriate consideration of potential earthquake-induced permanent ground deformation, especially at the existing treatment plant site because of the steep slope of the riverbank located in close proximity to the plant.

5.0 Limitations

The opinions and recommendations presented in this report were developed with the care commonly used as the state of practice of the profession. No other warranties are included, either expressed or implied, as to the professional advice included in this report. This report has been prepared for the City of Newberg to be used solely in its evaluation of the seismic safety of the water system components referenced. This report has not been prepared for use by other parties and may not contain sufficient information for purposes of other parties or uses.

References

ASCE. (2017a) ASCE 7-16, *Minimum Design Loads for Buildings and Other Structures*, American Society of Civil Engineers, Reston, VA.

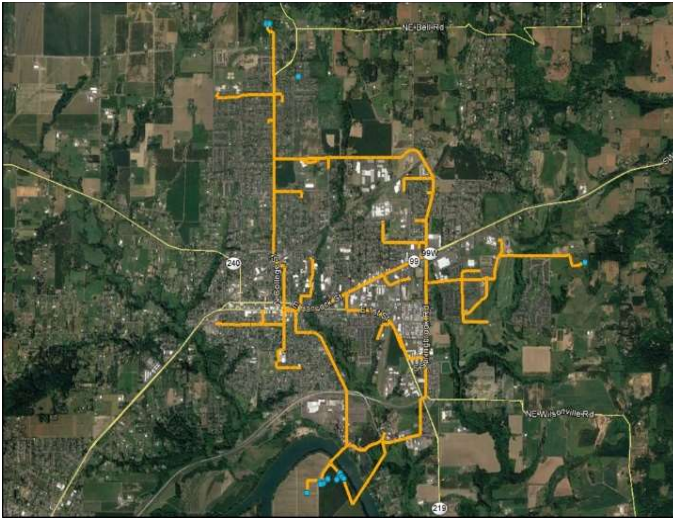
ASCE. (2017b). ASCE 41-17, *Seismic Evaluation and Retrofit of Existing Buildings*. American Society of Civil Engineers, Reston, VA

SEFT. (2019) *Water System Seismic Resilience Study, City of Newberg Public Works Department, Final Technical Memorandum: Seismic Recovery Goals*, Beaverton, OR.

Shannon & Wilson. (2019) *Geotechnical Engineering Report, City of Newberg Water System Seismic Resilience Study*, Lake Oswego, OR.

TCLEE. (2002). TCLEE Monograph No. 22, *Seismic Screening Checklists for Water and Wastewater Facilities*. American Society of Civil Engineers, Technical Council on Lifeline Earthquake Engineering, Reston, VA

AWWA. (2013). AWWA D110-13, *Wire- and Strand-Wound, Circular, Prestressed Concrete Water Tanks*. American Water Works Association. Denver, CO



Water System Vulnerability Assessment

Water System Seismic Resilience Study
City of Newberg, OR

July 20, 2020



Contents

1	Vulnerability Assessment	1
1.1	Structural Evaluation of Pipeline Bridge.....	1
1.1.1	Superstructure.....	2
1.1.2	Substructure	3
1.1.3	Geotechnical Hazards	4
1.1.4	24-inch Transmission Main	4
1.1.5	Summary	5
1.2	30-inch HDPE Transmission Main	6
1.3	Wellfield.....	7
1.4	Water System Backbone.....	8
1.5	Water Distribution Pipelines (non-backbone).....	12
1.6	Yard Pipeline Vulnerabilities	13
1.6.1	Water Treatment Plant	13
1.6.2	Water Storage Tanks	14
1.7	Water System Operations	15
1.8	Summary	15

Tables

Table 1.	ALA Pipeline Results.....	10
Table 2.	ALA Summary Non-Landslide Areas	11
Table 3.	ALA Summary for Landslide Areas.....	12
Table 4.	ALA Summary Non-Landslide Areas	12
Table 5.	ALA Summary of Landslide Areas	13
Table 6.	Summary of Vulnerabilities	16

Figures

Figure 1.	Pipeline Bridge Superstructure	3
Figure 2.	24-inch Water Transmission Main	5
Figure 3.	Soils at HDPE Crossing.....	6
Figure 4.	Wellfield	8
Figure 5.	Water System Backbone by Pipe Material	9
Figure 6.	North Valley Site	15

Acronyms

ALA	American Lifelines Alliance
CSZ	Cascadia Subduction Zone
GIS	geographic information system
HDPE	high-density polyethylene
ODOT	Oregon Department of Transportation
PGD	permanent ground displacement
PGV	peak ground velocity
WTP	water treatment plant

1 Vulnerability Assessment

This report is a component of the overall vulnerability assessment that covers the non-structural aspects of the City of Newberg's (City) water system, with the exception of the pipeline bridge. As a subconsultant to HDR, SEFT prepared the vulnerability assessment of the water treatment plant (WTP) and water storage tanks. The following items are included in this report:

- Pipeline bridge
- Wellfield
- 30-inch high-density polyethylene (HDPE) transmission main
- Water system backbone
- Water distribution system
- Yard piping at the WTP and water storage tanks
- Water system operations

Prior to the completion of this vulnerability assessment, Shannon and Wilson completed a geotechnical engineering report summarizing seismic hazards from a Cascadia Subduction Zone (CSZ) magnitude 9.0 event. From this analysis, mapping was generated to identify zones of peak ground velocity, probability of liquefaction, and landslide induced permanent ground deformation. Based on this information, calculations and observations were made with respect to the impact on water system components listed above.

On August 9, 2019, a site visit was conducted to visually inspect the water system infrastructure and interview City operations personnel regarding system components, functionality, operability, and known deficiencies. The site visit focused on the more visible components of the water system such as the WTP, water storage tanks, pipeline bridge, wellfield, and some buried items (e.g., vaults and valves). The operations personnel provided extensive background information about system operations and composition, which is incorporated into this assessment where applicable.

This vulnerability assessment includes a combination of quantitative and qualitative evaluation techniques. American Lifelines Alliance (ALA) methodology was used for the Quantitative analysis to assess damage of buried pipelines. This method incorporates site-specific geotechnical data to predict the total number of pipeline breaks. Although this approach results in defined data points, it is theoretical and subject to high levels of variance. Qualitative evaluation techniques, such as review of record drawings and cross-referencing geotechnical observations, were used to evaluate other components such as the wellfield and 30-inch HDPE transmission main.

1.1 Structural Evaluation of Pipeline Bridge

As part of the Water System Seismic Resilience Study for the City of Newberg, HDR evaluated the pipeline bridge over the Willamette River based on the documents

provided by the City, including past seismic evaluation reports and other public domain information available about this historic bridge.

The bridge is a three-span, cantilever deck truss, with a pony truss-type bridge making up the center span. The bridge was constructed in approximately 1917 by the Oregon State Highway Department (now known as the Oregon Department of Transportation [ODOT]). The central pony truss bears on the ends of the cantilever spans, which is a unique configuration. At some point, the structure was abandoned by ODOT and is now used by the City to carry its main water transmission line.

The structural evaluation was limited to a desktop study based on available information and noting general deficiencies and possible retrofits. As-built drawings are not currently available, therefore no numerical analysis was performed. If the City wishes to fully characterize the seismic hazards and investigate firm retrofit options, as-built drawings would be required.

1.1.1 Superstructure

The bridge superstructure (Figure 1) is constructed of a riveted truss with apparent pin bearing assemblies to the substructure. Because the photos do not show the abutments, their condition is unknown. Photos show the middle span bears on the cantilever arms, but the level of restraint is unclear. When the bridge was converted for waterline use, the deck was removed and waterlines and a catwalk installed on the existing floor beams. This helps the seismic performance of the bridge, as it reduces the seismic mass of the structure from its original configuration.

In general, older truss bridges were not designed for ductility and do not perform well in a seismic event. Retrofitting them to ensure ductile behavior is prohibitively expensive in most cases. A common retrofit procedure used with older truss bridges is replacing the bearings with isolation bearings. This method, also known as “base isolation,” allows the superstructure to move independently of the substructure, and minimizes the earthquake forces being transmitted to the bridge. On this bridge, the waterline would need to be isolated, which could likely be accomplished by replacing the fixed bearing waterline assemblies with rollers. The truss would need to be checked for seismic forces, as some seismic loads may affect the superstructure. However, any required modifications would likely be less costly than those required if no base isolation was performed.

Figure 1. Pipeline Bridge Superstructure



1.1.2 Substructure

Based on photos and descriptions in the seismic evaluation performed by Montgomery-Watson in 2011, the in-water piers appear steel jacketed concrete. In a seismic event, these may perform well; however, the embedment depth is unknown. If the piers are not embedded deep enough into the soil, they will lack sufficient overturning resistance and could fail during a seismic event from inertial loading. The depth of the existing piers, and additional capacity required to meet seismic loading, will drive the required mitigation method. The most likely retrofit strategy is installation of additional piles or localized ground improvements below the existing pier to provide additional lateral stability.

The details of the end abutments are unknown, however drawings from the 1927 repair suggest that the end abutments, Piers 1 and 4, are of similar construction to the main in-water piers. The 2011 seismic evaluation suggests an additional abutment was constructed at the north end when the trestles were removed. Without specific details, no additional recommendations can be provided regarding seismic upgrades to the end abutments.

1.1.3 Geotechnical Hazards

As part of the Geotechnical Engineering Study, Shannon and Wilson performed two borings and two CPT (Cone Penetration Test) runs at the western approach of the pipe bridge. A slope stability study also was performed at the west edge of the bridge. Bore log results show the site is underlain by silts and clays.

Shannon and Wilson's preliminary analysis indicates the slope is not stable for seismic or post-seismic conditions and the site may experience on the order of 2 feet of lateral spread due to liquefaction. Additional as-constructed details on the foundation system are required to accurately determine what vulnerabilities exist at this particular site. In general, these foundations do not perform well in soils that are subject to liquefaction and lateral spread, as they do not have adequate capacity to remain standing under large lateral pressures induced by liquefaction. Typical mitigation strategies include installation of additional piles and/or drilled shafts to improve the lateral capacity of the foundation, or ground improvements to protect the foundation from additional lateral loads.

1.1.4 24-inch Transmission Main

The 24-inch ductile iron water transmission is approximately 2,085 linear feet, installed in 1980 (Figure 2). This transmission main parallels and serves the same function as the 30-inch HDPE transmission main, by conveying raw water from the wellfield to the City's WTP. The pipeline shares the bridge deck with other power and communication pipelines/conduits. Because the pipeline is solely supported by the bridge, the pipeline will be subject to any failure modes experienced by the bridge in a seismic event. Isolation valves are located on each side of the bridge, which can provide isolation of the damage. Depending on how the bridge fails, damage to the interconnecting system, water loss, and potential cross-contamination may also occur.

Figure 2. 24-inch Water Transmission Main



1.1.5 Summary

Based on review of the available data, the pipeline bridge is unlikely to withstand a CSZ magnitude 9.0 earthquake and will require significant retrofits. This could cost in the tens-of-millions. Before further investigation and analysis can be performed, review of as-built construction documents and a comprehensive physical inspection would be necessary. A dive inspection also is recommended to assess the condition of the exposed foundation elements underwater.

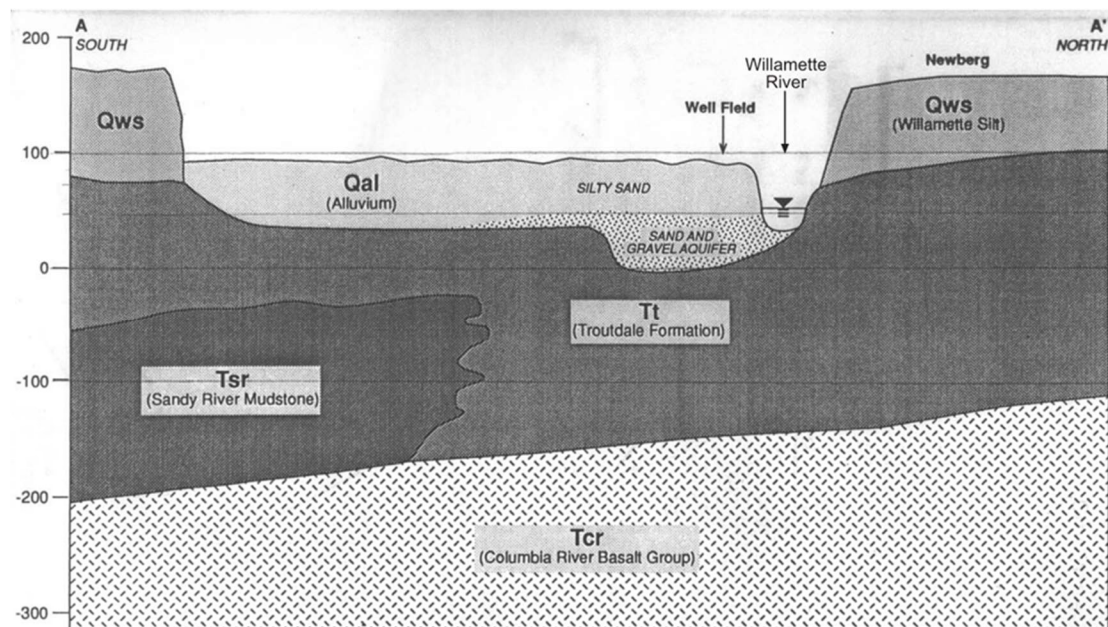
With regard to the 24-inch transmission main, it shares the same structural risks as the bridge. It is unlikely to survive a CSZ magnitude 9.0 seismic event. Because of its low resilience level, the water system is vulnerable to damage to the interconnecting system, water loss, and potential contamination. Isolation valves on either end of the bridge can be closed to minimize water loss if pipeline damage occurs, but they lack automation for quick closure and could be damaged during a CSZ event.

1.2 30-inch HDPE Transmission Main

In 2006, the 30-inch HDPE water transmission main was constructed using horizontal directional drilling under the Willamette River (Figure 3). It is approximately 2,600 linear feet, and extends several hundred feet beyond the river, ranging in depth from 50 feet directly under the river, to 175 feet below the west bank. As with the 24-inch transmission main, it conveys raw water from the City's wellfield to the WTP. Because of its unique construction and depth, Shannon and Wilson provided resilience observations specific to this transmission main crossing:

- According to geotechnical documents from the project, most of the undercrossing is within the Troutdale Formation. The Troutdale Formation is predominantly fine-grained (i.e., silts and clays), with medium to high plasticity. In general, material that is characterized as medium to high plasticity is not susceptible to liquefaction. The risk of liquefaction is likely low for most of the undercrossing.
- On the southern side of the river, the pipeline transitions into the surficial alluvial soils (i.e., wellfield area). This area may be susceptible to liquefaction induced settlement, which could induce differential settlement, especially where the pipeline transitions into the wellfield piping.
- Where the pipeline is at its shallowest on the northern side of the river, the pipeline is within approximately 400 feet of the bank of the Willamette River, and susceptible to lateral spreading. The magnitude of lateral spread at this distance is approximately 5 to 10 inches. Additional study, including explorations and laboratory testing would need to be performed to provide a more reliable estimate of the lateral spreading hazard at this location.

Figure 3. Soils at HDPE Crossing



In summary, the majority of the crossing has a low risk of damage during a CSZ event. Vulnerabilities posed by the 30-inch HDPE transmission main are focused on the zone

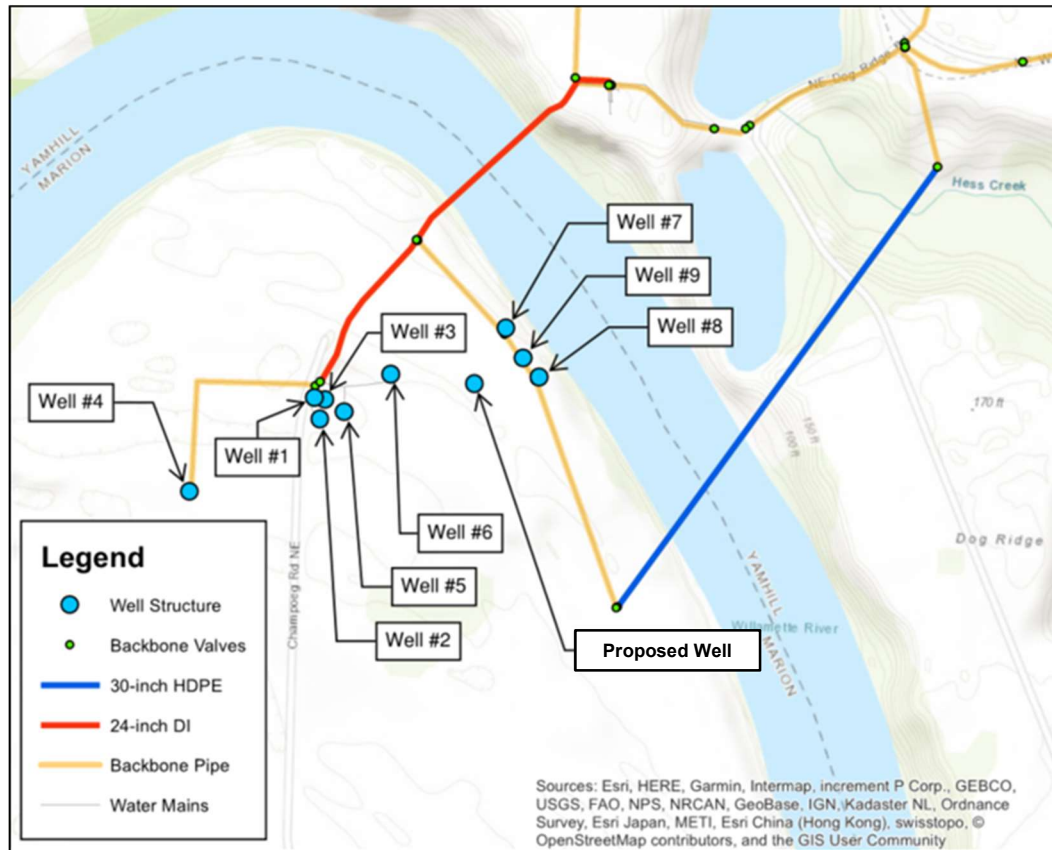
south of the river crossing in the wellfield area, and on the north side within 400 feet from the riverbank. In the wellfield area, differential settlement may occur between the HDPE line and wellfield lines, causing separation or damage. On the northern side, lateral spreading could cause pipe separation or damage.

1.3 Wellfield

The wellfield area is composed of nine wells on the southern side of the river (Figure 4). Currently, five of the nine wells are in operation. Construction of the wells occurred from as early as 1948 up to the present. Because the wellfield is composed of different types of infrastructure at different depths, and could experience impacts to groundwater during a seismic event, Shannon and Wilson provided a focused assessment of this area with the following key observations:

- According to the surficial geology mapped within the region and the available subsurface exploration logs, the surface soils near the well field will be predominantly alluvial soils. The alluvial soils encountered in nearby explorations are characterized as loose sands and gravels and non-plastic to low plasticity silts and were encountered to a depth of 70 feet below the ground surface (approximate elevation 15 feet). Groundwater is indicated at a depth of 24 feet. In general, loose sands and non-plastic to low plasticity silts below the water table will be susceptible to liquefaction.
- Based on the well descriptions in the water system plan, wells 1 through 3 have been removed from operation. Descriptions of wells 4 through 9 indicate that the wells were installed to total depths ranging from 88.5 to 96 feet below the ground surface with the screens placed within a sand and gravel aquifer that appears to overlie the Troutdale Formation and is part of the surficial alluvial soils. Therefore, the wells are likely at risk for liquefaction and lateral spread.
- Some of the consequences of seismic activity within the wellfield include:
 - Based on the proximity to the Willamette River, lateral spreading is likely the primary risk especially for wells near the bank of the Willamette River. Lateral spreading could cause significant lateral displacement of the well casing near the ground surface and above the river bottom. Lateral spreading magnitudes could range from 12 to 24 inches in this area with higher magnitudes closer to the river and then tapering down as you get farther from the river. The well descriptions indicate that wells 4 through 9 were installed with cement surface seals that ranged from 20 to 46 feet in thickness. The existing cement surface seals could help provide some lateral capacity for the well casings.
 - Liquefaction induced settlement is likely a secondary risk that could cause differential settlement between the well casing and pipe connection.
 - Seismic shaking could cause sand and other coarse particles to flow toward the well and plugging of the well screen reducing the capacity of the well.
 - Seismic shaking could cause groundwater levels to fluctuate.

Figure 4. Wellfield



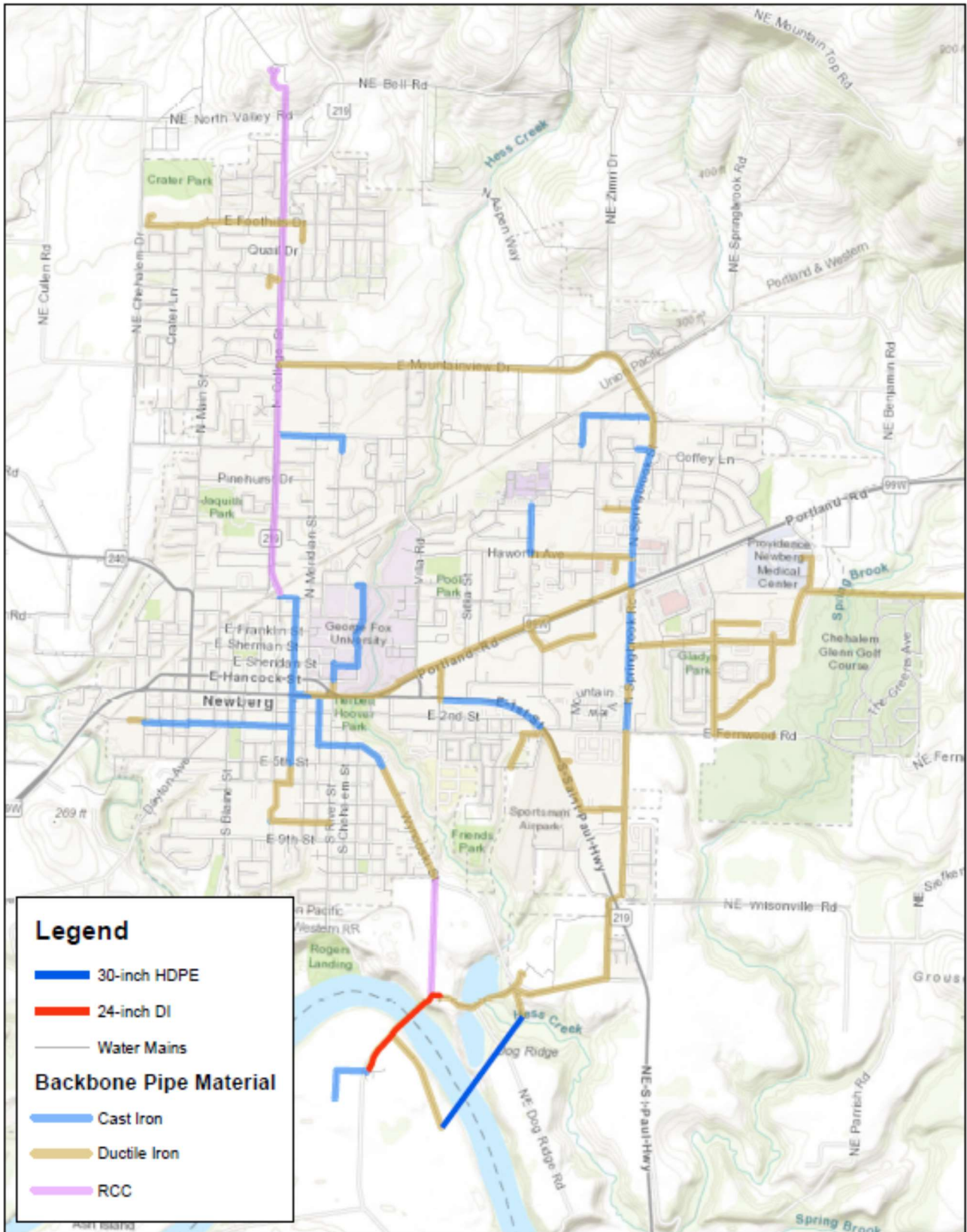
In summary, geotechnical vulnerabilities in the wellfield zone include significant lateral displacement for wells closest to the riverbank, differential settlement between wells and transmission pipelines, change in groundwater levels, and siltation of well screens. The following are additional vulnerabilities identified through discussion with operations personnel and review of record drawings:

- There is only one backup generator located at well 9. Considering that power may be disrupted for a long period of time, additional generators may be needed to provide adequate supply after a CSZ event.
- Because the wellfield is located on the other side of the Willamette River, City crews may not be able to access the wellfield quickly due to bridge failure or other access issues. This may make it difficult to access critical isolation valves (i.e., isolate 24-inch transmission main) or to provide fuel to the standby generator.

1.4 Water System Backbone

The water system backbone was identified in an early phase of this study in which level of service goals were established. Pipelines identified as part of the backbone are generally responsible for connecting all of the critical infrastructure such as the wells, WTP, primary transmission and distribution, and water storage tanks. The City's backbone water system consists of approximately 59 percent ductile iron, 24 percent cast iron, 13 percent concrete, 3 percent HDPE, and 2 percent other (Figure 5)

Figure 5. Water System Backbone by Pipe Material



A vulnerability assessment of the backbone was completed using the ALA procedure to evaluate the probability of earthquake damage. The ALA Pipeline Fragility Formulations consider the following factors that lead to damage of buried pipe in earthquakes:

- Ground shaking
- Landslides
- Liquefaction
- Settlement
- Fault crossings
- Continuous pipeline
- Segmented pipelines
- Appurtenances and branches
- Age and corrosion

The ALA outlines vulnerability functions focused on two specific mechanisms that cause pipe damage: *seismic wave passage* and *earthquake induced ground failure*. Wave passage is directly related to peak ground particle velocity (PGV) associated with ground shaking. Ground failure refers to permanent ground displacement (PGD) associated with landslides and liquefaction. The Geotechnical Engineering Report completed by Shannon & Wilson identifies the following related to PGV and PGD:

- Peak ground velocity (PGV)
- Liquefaction-induced lateral spread (PGD)
- Liquefaction-induced settlement (PGD)
- Landslide-induced PGD in both wet and dry conditions

This analysis applies the equations defined in the ALA with information provided in the geotechnical report. Non-geotechnical components, such as age and corrosion, are accounted for by applying a fragility curve modification factor. Key limitations of this analysis include quality of construction and consideration for pipeline restraint. Table 1 calculates the amount of damage for each significant pipe material:

Table 1. ALA Pipeline Results

Pipe Material	PGV	Liquefaction-induced lateral spread PGD	Liquefaction-induced settlement PGD	Landslide-induced PGD (dry)	Landslide-induced PGD (wet)
Cast Iron					
Hazard Score*	11.02 in/sec	2 in	1.5 in	24 in	180 in
Modification Factor	1.00	1.00	1.00	1.00	1.00
RR Score**	0.02	2.12	1.59	25.44	190.80
Est. Percentage of Pipe Impacted	100%	100%	100%	5%	5%
Est. Length of Pipe Impacted (ft.)	23860	23860	23860	1193	1193
Est. Total Breaks in Pipeline	0.49	50.58	37.94	30.35	227.62

Pipe Material	PGV	Liquefaction-induced lateral spread PGD	Liquefaction-induced settlement PGD	Landslide-induced PGD (dry)	Landslide-induced PGD (wet)
Ductile Iron					
Hazard Score*	11.02 in/sec	2 in	1.5 in	24 in	180 in
Modification Factor	0.50	0.50	0.50	0.50	0.50
RR Score**	0.01	1.06	0.80	12.72	95.40
Est. Percentage of Pipe Impacted	100%	100%	100%	5%	5%
Est. Length of Pipe Impacted (ft.)	58433	58433	58433	2922	2922
Est. Total Breaks in Pipeline	0.60	61.94	46.45	37.16	278.72
RCC					
Hazard Score*	11.02 in/sec	2 in	1.5 in	24 in	180 in
Modification Factor	1.00	1.00	1.00	1.00	1.00
RR Score**	0.02	2.12	1.59	25.44	190.80
Est. Percentage of Pipe Impacted	100%	100%	100%	5%	5%
Est. Length of Pipe Impacted (ft.)	12592	12592	12592	630	630
Est. Total Breaks in Pipeline	0.26	26.69	20.02	16.02	120.13

*Hazard Score estimated from Geotechnical Engineering Report (Shannon and Wilson)

** RR Score is calculated in breaks per 1,000 feet

The table shows that the amount of pipe damage is largely dependent on the pipe material and whether it is subject to liquefaction or landslide. Damage caused by PGV (shaking) is relatively minimal. Damage caused by liquefaction induced lateral spread or landslide induced deformation (dry) is comparable. If in wet soil conditions, the landslide induced deformation is magnitudes greater.

Table 2 and Table 3 further summarize the damage, separating non-landslide and landslide prone areas, respectively. The tables also include pipe length and material, with the majority of pipe located outside of landslide prone areas. For the non-landslide areas (Table 2), the total estimated number of pipeline breaks is 245, at a frequency of 3 per 1,000 feet (or an average of 387 feet between each break). As an example, if two repair crews could repair four locations per day, it would require a total of 60 days to repair the non-landslide backbone area. For the landslide prone areas, there is a dramatic difference between dry and wet conditions. Under the same scenario, repairs would take an additional 21 to 156 days to repair. In reality, those pipelines would require full replacement, whether it was wet or dry, because of the breakage frequency.

Table 2. ALA Summary Non-Landslide Areas

Pipe Material	Total Material Length Within Geo-Hazard (ft)	Percentage of Backbone Total	Est. Total No. of Breaks	Est. No. of Breaks per 1,000 ft.	Est. Space Between Breaks (ft)
Cast Iron	23,860	25%	89	4	268
Ductile Iron	58,433	62%	109	2	536
RCC	12,592	13%	47	4	268
Grand Total	94,884	100%	245	3	387

Table note: Estimated Number of Breaks Due to PGV and PGD (non-landslide) by Pipe Material

Table 3. ALA Summary for Landslide Areas

Pipe Material	Total Material Length Within Geo-Hazard(ft.)	Percentage of Backbone Total	Est. Total No. of Breaks	Est. No. of Breaks per 1,000 ft.	Est. Space Between Breaks (ft.)
Cast Iron	1,193	1%	30-228	25-191	5-39
Ductile Iron	2,922	3%	37-279	13-95	10-79
RCC	630	1%	16-120	25-191	5-39
Grand Total	4,744	5%	84-626	64-477	5-79

Table note: Estimated Number of Breaks Due to PGD (landslide) by Pipe Material

1.5 Water Distribution Pipelines (non-backbone)

The water system distribution network represents the highest quantity of water pipelines, but is also considered a lower priority for seismic resilience. In terms of composition, the network includes approximately 63 percent ductile iron, 23 percent cast iron, 9 percent PVC, and 5 percent other.

For simplicity of presentation, only the summary tables for non-landslide and landslide areas are provided (Table 4 and Table 5, respectively). For most of the distribution system (non-landslide), results show 1,159 water main breaks at a frequency of 2 per 1,000 feet (403 feet between each break; Table 4). Under the previously assumed scenario of repairing four locations per day (two crews at two repairs per day), repairs would require 290 days. For the landslide prone areas, a range of 336 to 2,518 breaks would occur and require a range of 84 to 630 days to repair. As in the case with the backbone system, those pipelines in the landslide prone areas would likely require full replacement instead of repair.

Table 4. ALA Summary Non-Landslide Areas

Pipe Material	Total Material Length Within Geo-Hazard (ft)	Percentage of Distribution Total	Est. Total No. of Breaks	Est. No. of Breaks per 1,000 ft.	Est. Space Between Breaks (ft)
C-900	11,713	3%	35	3	336
CI	106,470	23%	397	4	268
DI	296,271	63%	553	2	536
PVC	28,707	6%	85	3	336
Other	23,905	5%	89	4	268
Grand Total	467,065	100%	1,159	2	403

Table note: Estimated Number of Breaks Due to PGV and PGD (non-landslide) by Pipe Material

Table 5. ALA Summary of Landslide Areas

Pipe Material	Total Material Length Within Geo-Hazard(ft.)	Percentage of Distribution Total	Est. Total No. of Breaks	Est. No. of Breaks per 1,000 ft.	Est. Space Between Breaks (ft.)
C-900	586	3%	12-89	20-153	7-49
CI	5,324	23%	135-1,016	25-191	5-39
DI	14,814	63%	188-1,413	13-95	10-79
PVC	1,435	6%	29-219	20-153	7-49
Other	1,195	5%	30-228	25-191	5-39
Grand Total	23,353	100%	336-2,518	59-439	5-79

Table note: Estimated Number of Breaks Due to PGD (landslide) by Pipe Material

1.6 Yard Pipeline Vulnerabilities

An important component of water system resilience is to evaluate how the critical structures are connected to the transmission/distribution system. This includes not only pipeline construction, but also placement of seismic couplings, isolation valves, pressure-regulating valves, and remote monitoring or control capability. For this evaluation, vulnerabilities were identified through site visit observations, interview of operations personnel, and review of record drawings. Evaluated locations included yard pipelines (exterior to the building) for the WTP and water storage tank sites.

1.6.1 Water Treatment Plant

WTP vulnerabilities and observations include the following:

- There is a remotely operable isolation valve at the inlet to the WTP, but not a remotely operable isolation valve on the discharge to the WTP. If a seismic event occurred, the WTP may not be immediately isolated from the water system, creating more potential for water loss or cross-contamination.
- There are no known control valves (hydraulic pressure sustaining valves) on the inlet or outlet sides of the WTP that would engage automatically to isolate the WTP, thereby preserving water storage in the WTP and preventing cross-contamination.
- There is no bypass line around the WTP that would connect raw water transmission from the wellfield to the distribution system. This means that supplying water after a seismic event would depend on repair and recovery of the WTP. A bypass would allow temporary raw water for firefighting and domestic use (boiling would be needed for drinking).
- Based on record drawings, there are couplings located at pipeline building penetrations that may allow minimal movement; however, they are not seismically resistant. Differential settlement could occur between the structure and outside pipelines. Lateral spreading may also cause pipe separation.

1.6.2 Water Storage Tanks

There are two water storage tank sites; the Corral Creek Road Reservoir east of the City and the North Valley water storage tanks north of the City. Vulnerabilities and observations include the following:

Corral Creek Site

- Pipeline connections along the exterior of the water tank are fitted with flexible couplings. Given the relatively low amount of liquefaction and lateral spreading predicted, these may be adequate for movement that may occur. These couplings, however, do not provide the amount of protection that a seismic coupling provides.
- A landslide may result in up to 6 inches of lateral spread approximately 100 feet from the reservoir. There are no seismic couplings in the pipeline that could accommodate this movement, which could lead to pipe separation.
- There is a remotely operable isolation valve on the inlet/outlet line to the water tank, allowing for quick isolation and protection of the water storage in the tank during and after an event. There is not, however, a hydraulic control valve, that could operate and close independently of the SCADA system (if down) to protect the water storage.

North Valley Water Storage Tanks

- This site location (Figure 6) is subject to higher magnitudes of permanent ground deformation. Differential settlement of approximately 0.5 to 1.5 inches could occur between structures and connecting pipelines. It is unknown if exterior couplings could absorb this movement.
- The inlet/outlet line to the site will be subject to landslide movement up to 2 feet. This is a significant range of movement that would require one or more seismic couplings to absorb. In its current state, pipeline separation likely would occur.
- There is a remotely operable isolation valve on the inlet/outlet line to the water tank, allowing for quick isolation and protection of the water storage in the tank during and after an event. There is not, however, a hydraulic control valve, that could operate and close independently of the SCADA system (if down) to protect the water storage.

Figure 6. North Valley Site



1.7 Water System Operations

From an operational perspective, the following vulnerabilities and observations were gathered from a number of sources including review of the most current water system plan, site visit, review of record drawings, and interviews with operations personnel.

- The City operates at relatively high average system pressures. There are no fire-flow or pressure deficiencies identified that could affect system recovery after a CSV event.
- There are no current deficiencies in water system storage capacity.
- The SCADA system could be improved or expanded to include greater centralized monitoring and control of the system. Identify locations without backup battery power. Engage power and communications utilities to gauge utility resilience and backup measures.
- Not having a redundant water supply in an alternate geographic location creates a significant vulnerability for the water system. It is understood the City is actively pursuing redundant water supply options.
- Ensure geographic information system (GIS) mapping is adequately detailed to locate critical isolation valves and facilities in an emergency.

1.8 Summary

This study identified several water system vulnerabilities associated with the pipeline bridge, 30-inch HDPE transmission main, wellfield, water system backbone, water

distribution network, and system operations. The probability and magnitude of the damage that could occur depends on both qualitative and quantitative assessments; meaning that there are a wide range of possible outcomes. With careful consideration of these assessments, a picture of the potential damage can be drawn, and can then lead to development of priorities and improvements.

Table 6 summarizes the vulnerabilities for each water system component and includes an estimated recovery period for repair or replacement.

Table 6. Summary of Vulnerabilities

Component	Vulnerabilities	Estimated Recovery Period (days)
Pipeline Bridge	<ul style="list-style-type: none"> • Superstructure not designed for ductility • Substructure compromised by liquefaction and lateral spread • Pipeline will fail with the bridge and risk damage to connecting system, water loss, and contamination 	Unlikely repairable and not cost effective to re-build
30-inch HDPE Line	<ul style="list-style-type: none"> • On northern side of river, pipe separation likely due to lateral spread • On southern side of river, liquefaction induced differential settlement with wellfield transmission lines 	If the damage is isolated, repair could be in the range of two weeks. Access issues may prevent repair
Wellfield	<ul style="list-style-type: none"> • Insufficient backup power generation • Lateral spread and liquefaction could cause irreparable damage to deep wells • Potential siltation and changes to groundwater levels 	Damage could be severe and require several months for new well construction
Water System Backbone	<ul style="list-style-type: none"> • Pipeline breaks due to lateral spread, settlement, and landslide 	Approximately 60 days for non-landslide, and 21 to 156 days for landslide areas
Water Distribution	<ul style="list-style-type: none"> • Pipeline breaks due to lateral spread, settlement, and landslide 	Approximately 290 days for non-landslide, and 84 to 630 days for landslide area
Yard Piping	<ul style="list-style-type: none"> • Loss of water storage due to absence of automated hydraulic control valves • Loss of storage due to absence of seismic couplings at structures or landslide zones • No bypass around WTP 	Repair could be within a month, but water loss could be costly to the community during recovery



Appendix D: Mitigation Recommendations

Memo

Date: Friday, April 24, 2020

Project: Seismic Resilience Assessment

To: Brett Musick, PE, City of Newberg

From: Andy McCaskill, P.E.; Chad Gipson, P.E.; Katie Walker, P.E.

Subject: WTP Seismic Resiliency Cost Estimates

Introduction

Due to a potential Cascadia Subduction Zone event, the City of Newberg, OR is evaluating its water system to identify gaps in seismic resiliency. The existing water treatment plant (WTP) consists of vintage concrete structures not designed or detailed for current seismic codes. To mitigate this risk, significant work is required to perform a detailed seismic analysis of the existing structures and develop a structural retrofit and reinforcement scheme for the facility. The existing WTP site is also susceptible to lateral spreading during an earthquake, which would cause extensive damage to the plant without significant ground improvements. The purpose of this memorandum is provide information on the estimated cost to retrofit the existing WTP structures and perform ground improvements to mitigate lateral spreading at the existing plant, as well as the cost of building a new WTP.

Current Water Treatment Plant – Seismic Mitigation

The following cost estimate was developed primarily based on the seismic deficiency findings developed by SEFT (September 2019), using the ASCE41 Tier 1 seismic deficiency checklist method. Based on those findings, HDR developed rough order of magnitude cost estimates to perform seismic retrofits to address these deficiencies in order to meet the Basic Performance Objective for Existing Buildings (BPOE) criteria for a Risk Category IV essential facility in accordance with ASCE41 recommendations and guidelines.

The cost estimate is based solely on addressing seismic deficiencies identified in the Tier 1 assessment. It should be noted that some structures are approaching the end of their useful design life and there are potentially other deficiencies not addressed by the seismic retrofits.

It should be noted that the geotechnical investigation performed by Shannon and Wilson (July 2019) indicated that the existing plant is susceptible to liquefaction, ground deformation and lateral spreading. It is assumed that given the estimated level of settlement during a seismic event (approximately 1 inch), that most of the structures within the plant can tolerate this settlement with minimal impact to operations or life safety during a Cascadia Subduction Zone (CSZ) earthquake. As such, it is assumed that piles or deep foundation elements are not required at the existing plant to mitigate for liquefaction induced settlement.

However, the estimated seismic induced lateral spread movement is expected to be several feet. This is generally mitigated through the installation of ground improvements between the



site and the shoreline to help buttress the site and prevent lateral movement. While detailed design of ground improvements is determined by the geotechnical engineer, HDR used unit costs based on past project experience with similar seismic hazards in order to estimate the magnitude of ground improvement costs for this site.

Table 1 presents the summary of the cost estimate for seismic mitigation improvements to the existing WTP based on the findings from the SEFT report.

Table 1: Existing WTP Seismic Mitigation Cost Estimate

Description	Cost
Original Control Building	\$ 320,000
1961 Control Building Addition	\$ 325,000
1970 Control Building Addition	\$ 350,000
Sedimentation Basin #1	\$ 205,000
Sedimentation Basin #2 (not in SEFT study)	\$ 205,000
Filter Gallery and Clearwell	\$ 245,000
Pump Room	\$ 170,000
Filters	\$ 150,000
Sodium Hypochlorite Building	\$ 50,000
Subtotal Seismic Retrofits	\$ 2,020,000
Nonstructural Seismic Mitigation (25%)	\$ 505,000
Ground Improvements	\$ 2,000,000
Subtotal	\$ 4,525,000
Engineering and permitting (15%)	\$ 680,000
Contingency (25%)	\$ 1,300,000
Total	\$ 6,505,000

Conceptual level cost estimates for an AACE Class 5 estimate can range from -50% on the low end and up to 100% on the high end. Using the cost estimate presented in Table 1, the range of the WTP construction cost estimate could be from approximately \$3.3M to \$13M.

New Water Treatment Plant

The cost estimate for a new water treatment plant is based on the design criteria outlined in Section 7 of the 2002 Water Treatment Facility Plan. The treatment process are identified as follows:

- Oxidation Contact Basins – use chlorine to oxidize iron
- Dissolved Air Flotation – removes iron solids
- Granular Media Filters – filtration
- Clearwell – storage and additional disinfection contact time
- Sludge Pump Station – sends solids from DAF to the sludge thickener
- Backwash Equalization Basin – stores backwash waste from the filter before sending to sanitary sewer



- Sludge Thickener – thickens solids before discharge to sanitary sewer

Table 2 presents the design criteria used in the cost estimate.

Table 2: New WTP Cost Estimate Design Criteria

Parameter	Design Value or Specification
Initial Maximum Design Flow	12 million gallons per day (MGD)
Oxidation Contact Basins	Number of units: 3, initially Design contact time: 15 minutes
Dissolved Air Flotation	Number of units: 3, initially Surface loading rate: 6 gallons per square foot (gpm/sf)
Granular Media Filters	Number of units: 4, initially Filter loading rate: 6 gpm/sf Area of each filter: 384 sf Depth of media: 5 feet (1 foot sand, 4 feet anthracite)
Clearwell	Storage: 1 million gallons
Sludge Pump Station	Pumps: 1 duty + 1 standby Horsepower: assumed 2 hp
Backwash Equalization Basin	Backwash flow rate: 20 gpm/sf Backwash duration: 10 minutes Filter to waste flow rate: 6 gpm/sf Filter to waste duration: 5 minutes Number of stored backwashes: 4
Backwash Supply Pump Station	Pumps: 1 duty + 1 standby Horsepower: assumed 125 hp
High Service Pump Station	Pumps: 5 duty + 1 standby Horsepower: assumed 100 hp
Chemical Systems	Coagulant: tank plus metering pumps (1 duty + 1 standby) Sodium Hydroxide (caustic): tank plus metering pumps (1 duty + 1 standby) Filter Aid Polymer: 1 tote with mixer, 1 blending skid Sludge Thickener Polymer: 2 tote with mixer, 1 blending skid Chlorine: none (assumed City would transfer existing chlorine generation system to the new plant)
Administrative Building	Size: 3,750 feet

Table 3 presents the summary of the cost estimate for a new WTP. This estimate does not include any requirements for offsite work, such as installation new electrical lines, raw or finished water pipelines.

Table 3: New WTP Conceptual Cost Estimate

Description	Cost
Administration Building	\$ 1,218,750
Chemical Systems	\$ 421,000
Site Civil	\$ 927,000
Seismic Mitigation	\$ 927,000
Generators	\$ 500,000
Oxidation Contact Basins	\$ 329,500



Description	Cost
Dissolved Air Flotation	\$ 1,841,000
Filtration	\$ 1,143,000
Solids Handling	\$ 899,750
Clearwell	\$ 2,570,750
Piping	\$ 842,000
Electrical/I&C	\$ 2,156,000
Start-up Costs	\$ 275,600
Subtotal	\$ 14,051,350
Engineering and permitting (15%)	\$ 2,108,000
Contractor OH/Profit/Mob/Insurance/GC	\$ 3,513,000
Subtotal	\$ 19,672,350
Contingency (25%)	\$ 4,918,000
Total	\$ 24,590,350

Conceptual level cost estimates can range from -50% on the low end and up to 100% on the high end. Using the cost estimate presented in Table , the range of the WTP construction cost estimate could be from approximately \$12.3M to \$49.2M.



Memo

Date: Monday, June 22, 2020

Project: City of Newberg Seismic Resilience Assessment

To: Brett Musick, PE, City of Newberg

From: Andy McCaskill, PE; Katie Walker, PE

Subject: Seismic Resilience Assessment – Mitigation Recommendations

Introduction

The City of Newberg (City) is conducting a seismic resilience assessment (SRA) to assess vulnerabilities in their system and identify mitigation strategies to meet their level-of-service (LOS) goals during and after a Cascadia Subduction Zone (CSZ) event. Previous mitigation strategies identified as part of the SRA include the rehabilitation of the existing water treatment plant and construction of a greenfield water treatment plant. The purpose of this memorandum is to present the following three additional recommendations to mitigate seismic challenges:

1. Emergency Connection and Control at the Water Treatment Plant (WTP)
2. Seismic Improvements at Corral Creek and North Valley Water Storage Tanks (WSTs)
3. Cast Iron and Concrete Pipe Replacement

The following sections describe these recommendations in more detail and include a conceptual design and construction cost estimate.

Mitigation Recommendation 1 – Emergency Connection and Control at WTP

As documented in other studies, the WTP is susceptible to several seismic risks including slope instability, liquefaction, and lateral induced settlement. Since all water to the City's distribution system currently runs through the WTP and repairs at the plant will likely be needed following a CSV event, the installation of a WTP emergency connection point is recommended. This emergency connection would provide a point where the raw water line could be connected to the finished water line (see Appendix A), allowing raw water to be used in the community for firefighting and domestic use (must be boiled for potable consumption). To facilitate the connection, tees are to be added to the raw and finished water pipeline with isolation valves installed in a connection vault (see Figure 1). A spool piece would be added during an emergency to provide a cross-connection point. The conceptual cost for this item is approximately \$200K. One future item for consideration includes modeling the City's system hydraulics and pressures to evaluate how to operate the emergency connection and if additional appurtenances are required.

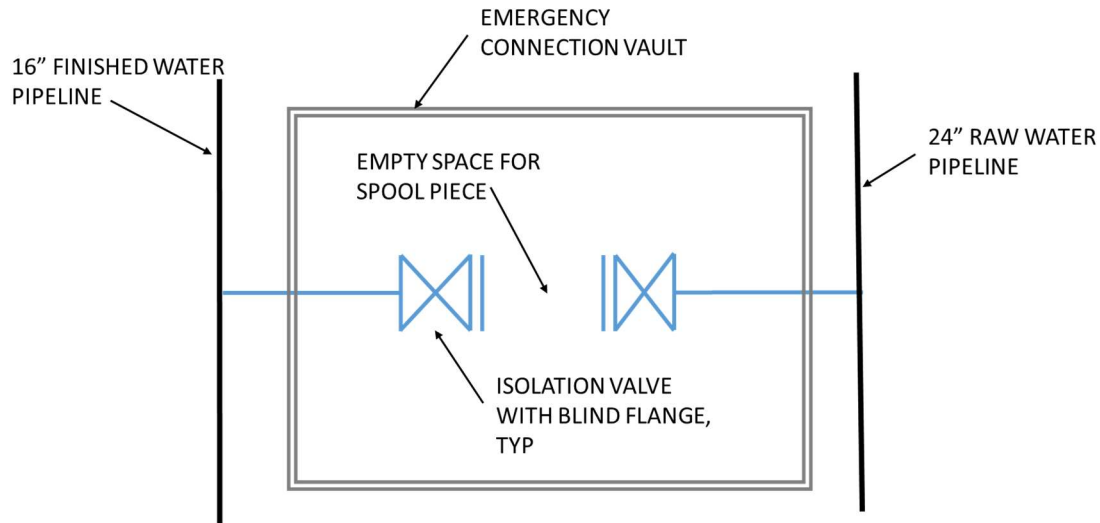


Figure 1. Raw Water Emergency Connection Vault

In addition, it is recommended that a hydraulically actuated pressure sustaining valve be installed on the raw water line that would close in the case of a pressure drop upstream, potentially due to a pipeline bridge failure or transmission main break. This valve would automatically close to prevent the water system from bleeding back into the river or wellfield area if there is a transmission main break. The conceptual cost for this item is approximately \$300K. One future item for consideration includes modeling the City's system hydraulics and pressures to refine the pressure sustaining valve operation.

Mitigation Recommendation 2 – Seismic Improvements at Corral Creek and North Valley WSTs

Conceptual layouts for these improvements are presented in Appendix B.

Corral Creek WST Improvements

Pipeline separation, and subsequent water loss, was identified as a main vulnerability at the Corral Creek WST. It is recommended that a hydraulically actuated pressure sustaining valve be installed on the inlet/outlet to the tank to preserve water storage if a pipeline break occurs. The conceptual cost for this item is approximately \$300K. Future items for consideration include modeling the City's system hydraulics and pressures to refine the pressure sustaining valve operation, and evaluating an option to retrofit the existing altitude vault.

North Valley WSTs Improvements

The North Valley WSTs have a similar vulnerability for water loss as the Corral Creek WST; a hydraulically actuated pressure sustaining valve is also recommended for installation on the inlet/outlet. The conceptual cost for this item is approximately \$300K. One future item for consideration includes modeling the City's system hydraulics and pressures to refine the pressure sustaining valve operation.

In addition to the valve, it is recommended that the portion of the concrete pipeline from the tank to NE North Valley Road be replaced due to the potential for landslide in the area and the lack

of seismic resiliency within the pipeline. Approximately 800 linear feet of 24” pipeline is recommended to be replaced with restrained joint ductile iron pipe at a conceptual cost estimate of \$450K.

Mitigation Recommendation 3 – Cast Iron and Concrete Pipe Replacement

The survey of the City’s backbone identified that it contains approximately 24% cast iron pipe and 13% concrete pipe (see Appendix C). The vulnerability assessment identified that a majority of the breaks in the system’s backbone will occur in these pipe materials and will likely not be repairable following a CSZ event. Table 1 presents the breakdown of pipe sizes by pipe material.

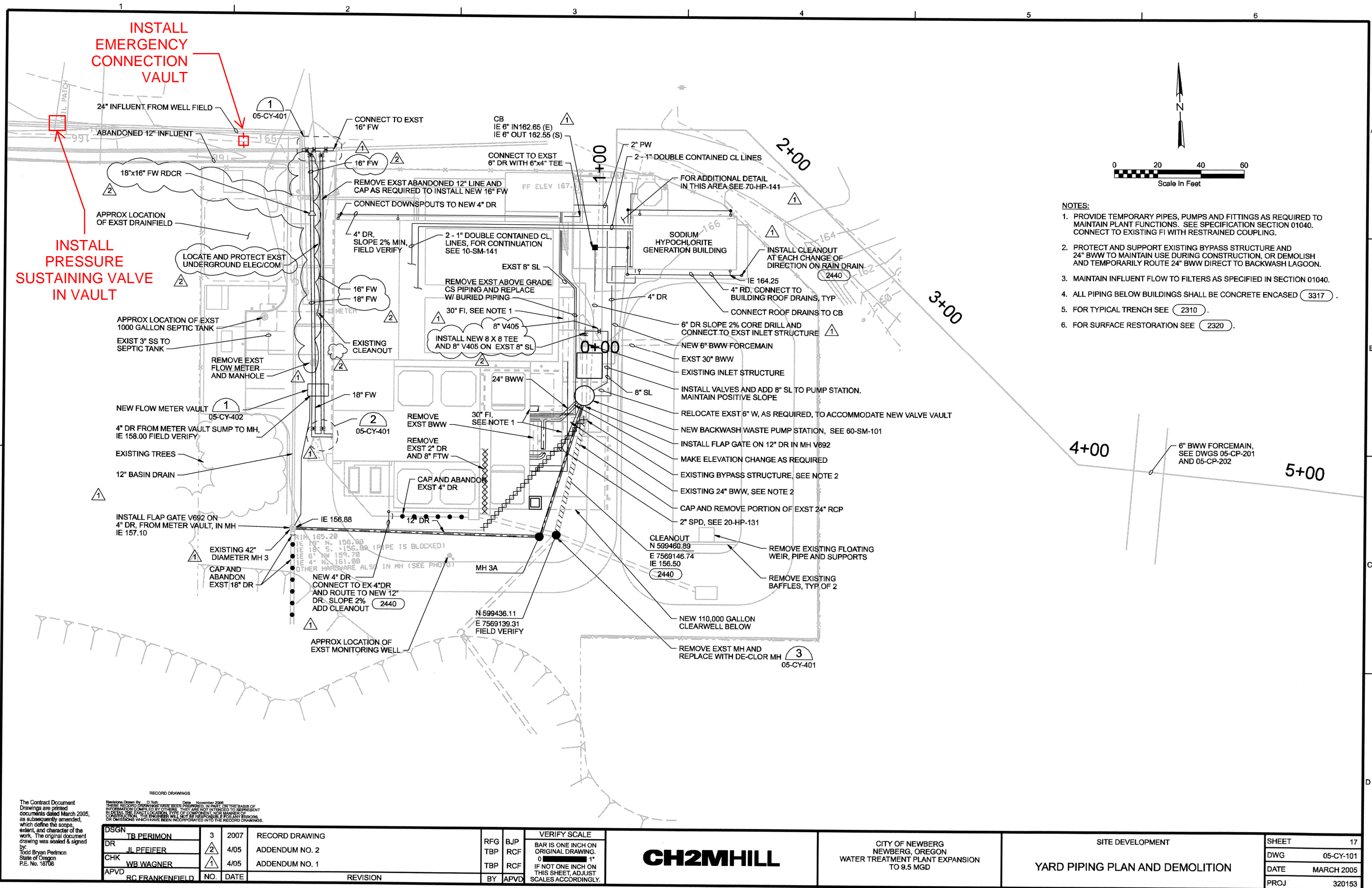
Table 1. Backbone Pipe Replacement by Pipe Size and Material

Pipe Diameter	Linear Feet of Pipe		Total Linear Feet of Pipe
	Cast Iron	Concrete	
6"	1,500	0	1,500
8"	7,979	0	7,979
10"	3,520	0	3,520
12"	6,850	17	6,867
14"	60	0	60
16"	0	2,600	2,600
18"	4,920	9,030	13,950
24"	0	950	950
Total			37,426

It is recommended that these pipes be replaced with restrained joint ductile iron pipe to reduce the recovery time for the water system backbone. A portion of the concrete pipe identified in this table is also recommended to be replaced under Mitigation Recommendation 2 – North Valley WSTs. The conceptual cost for this item is approximately \$12.5M and assumes an additional 10% pipe replacement.

Appendix A:

Mitigation Recommendation 1 – Conceptual WTP Improvements



- NOTES:**
1. PROVIDE TEMPORARY PIPES, PUMPS AND FITTINGS AS REQUIRED TO MAINTAIN PLANT FUNCTIONS. SEE SPECIFICATION SECTION 01040. CONNECT TO EXISTING FI WITH RESTRAINED COUPLING.
 2. PROTECT AND SUPPORT EXISTING BYPASS STRUCTURE AND 24" BWW TO MAINTAIN USE DURING CONSTRUCTION, OR DEMOLISH AND TEMPORARILY ROUTE 24" BWW DIRECT TO BACKWASH LAGOON.
 3. MAINTAIN INFLUENT FLOW TO FILTERS AS SPECIFIED IN SECTION 01040.
 4. ALL PIPING BELOW BUILDINGS SHALL BE CONCRETE ENCASED (3317).
 5. FOR TYPICAL TRENCH SEE (2310).
 6. FOR SURFACE RESTORATION SEE (2320).

The Contract Document Drawings are printed documents dated March 2005, as subsequently amended, which define the scope, extent, and character of the work. The original document drawing was sealed & signed by:
 Todd Bryan Perimon
 State of Oregon
 P.E. No. 18706

RECORD DRAWINGS

DSGN	TB PERIMON	3	2007	RECORD DRAWING
DR	JL PFEIFER	2	4/05	ADDENDUM NO. 2
CHK	WB WAGNER	1	4/05	ADDENDUM NO. 1
APVD	RC FRANKENFIELD	NO.	DATE	REVISION

RFG	BJP	VERIFY SCALE
TBP	RCF	BAR IS ONE INCH ON ORIGINAL DRAWING.
TBP	RCF	0 = 1"
BY	APVD	IF NOT ONE INCH ON THIS SHEET, ADJUST SCALES ACCORDINGLY.

CH2MHILL

CITY OF NEWBERG
 NEWBERG, OREGON
 WATER TREATMENT PLANT EXPANSION
 TO 9.5 MGD

SITE DEVELOPMENT
 YARD PIPING PLAN AND DEMOLITION

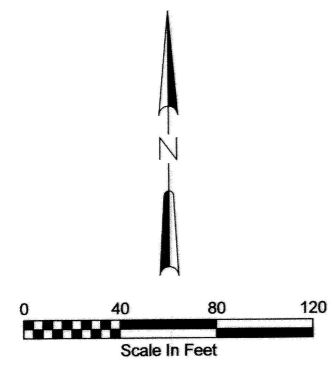
SHEET	17
DWG	05-CY-101
DATE	MARCH 2005
PROJ	320153

A1007005T

REUSE OF DOCUMENTS: CH2M HILL AND IS NOT TO BE USED, IN WHOLE OR IN PART, FOR ANY OTHER PROJECT WITHOUT THE WRITTEN AUTHORIZATION OF CH2M HILL.

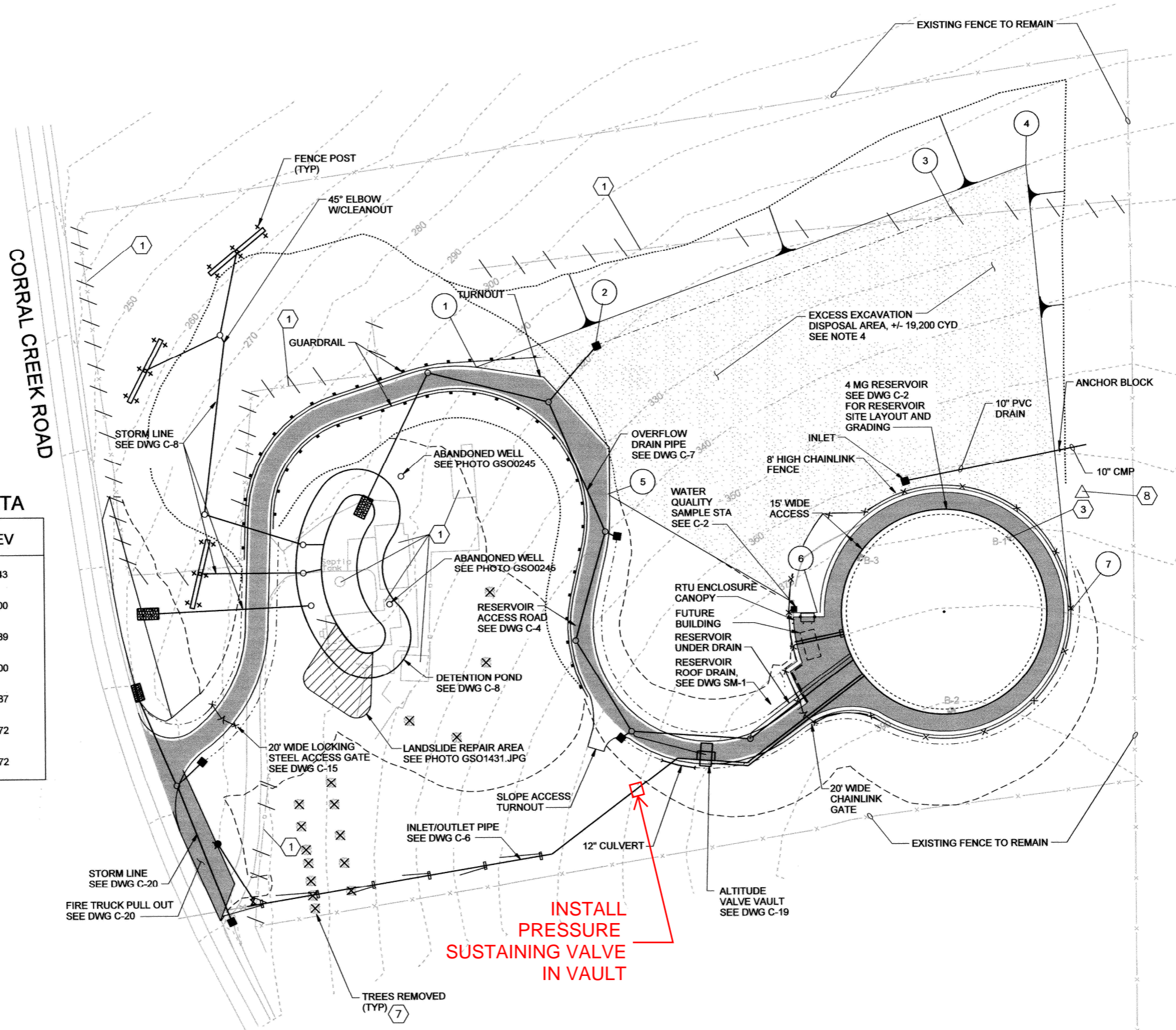
Appendix B:

Mitigation Recommendation 2 – Conceptual WSTs Improvements



DISPOSAL AREA LOCATION DATA

PT NO	COORDINATES		ELEV
1	N 607081.25	E 7579315.66	324.43
2	N 607096.02	E 7579399.95	323.00
3	N 607187.30	E 7579653.44	329.89
4	N 607221.41	E 7579704.92	335.00
5	N 606990.61	E 7579407.80	338.87
6	N 606905.65	E 7579555.30	378.72
7	N 606905.65	E 7579734.30	378.72



- LEGEND:**
- B-1 BORING LOCATIONS (CH2M HILL, JUNE 2000)
 - ASPHALT PAVEMENT
 - TOE OF FILL
 - CUT SLOPE LIMIT
 - BOTTOM OF DITCH
 - FENCE DEMOLITION
 - EXISTING CONTOURS

- NOTES:**
- 1 MAN-MADE FEATURES TO BE DEMOLISHED INCLUDE, BUT ARE NOT LIMITED TO:
 - A. HOUSE FOUNDATION *
 - B. GARAGE BARN FOUNDATION *
 - C. SEPTIC SYSTEM
 - D. FENCE
 - E. GRAVEL ACCESS ROAD
 - F. CONCRETE VAULT STRUCTURE
 - G. STONE SHED
 - H. BRICKPATIO
 - * WOOD STRUCTURES WERE BURNED 04/07/2002
 - 2 CONTRACTOR STAGING AREA MAY BE ANYWHERE ON SITE, WITHIN CLEARING LIMIT FENCE SHOWN ON DWG C-9
 - 3 ABANDON PIEZOMETER
 - 4 ADJUST FINISHED ELEVATION OF DISPOSAL AREA TO WASTE ACTUAL QUANTITY OF EXCESS EXCAVATION MATERIAL. PROVIDE UNIFORM SURFACE THAT DRAINS TO DITCH INLET
 - 5 SEE ELECTRICAL PLAN FOR POWER POLE LOCATIONS.
 - 6 BOUNDARY SURVEY WAS COMPLETED BY MATT DUNCKEL & ASSOC. IN APRIL 2002. SUCCESSFUL BIDDER MAY OBTAIN COPY OF SURVEY FROM THE CITY OF NEWBERG.
 - 7 X TREE REMOVED FOR CONSTRUCTION
 - 8 CONSTRUCTION TBM-2 RR SPIKE IN 10" FIR TREE ± 50' N TANK ELEVATION 371.26 NGVD 1929

INSTALL
PRESSURE
SUSTAINING VALVE
IN VAULT

RECORD DRAWINGS

Revisions Drawn By Prisciliano Peralta Date Feb 2004

THESE RECORD DRAWINGS HAVE BEEN PREPARED, IN PART, ON THE BASIS OF INFORMATION COMPILED BY OTHERS. THEY ARE NOT INTENDED TO REPRESENT IN DETAIL THE EXACT LOCATION, TYPE OF COMPONENT NOR MANNER OF CONSTRUCTION. THE ENGINEER WILL NOT BE RESPONSIBLE FOR ANY ERRORS OR OMISSIONS WHICH HAVE BEEN INCORPORATED INTO THE RECORD DRAWINGS.

VERIFY SCALE
BAR IS ONE INCH ON ORIGINAL DRAWING.
IF NOT ONE INCH ON THIS SHEET, ADJUST SCALES ACCORDINGLY.



CITY OF NEWBERG
NEWBERG, OREGON
CORRAL CREEK ROAD
4.0 MG RESERVOIR

CORRAL CREEK ROAD RESERVOIR
SITE WORK
SITE PLAN

A2004001D

SHEET	4
DWG	C-1
DATE	APRIL 2002
PROJ	167877

The Contract Document Drawings are printed documents dated April 2002, as subsequently amended, which define the scope, extent, and character of the work. The original document drawing was sealed and signed by Tim G. Yamada, State of Oregon, P.E. No. 62607PE, dated November 9, 1999.

NO.	DATE	REVISION	BY	APVD
DSGN			T. YAMADA	
DR			H. GIFFORD	
CHK			B. WAGNBR	
APVD			BJ PHELPS	

27/2017 1:58 PM
 STEPHANIE GOTSCH
 I:\Projects\101091031_20-Newberg_NorthValley\1091031\1091031_REC.dwg



- NOTES:**
- CONTRACTOR IS RESPONSIBLE FOR MAKING IMPROVEMENTS TO EXISTING ACCESS ROAD THAT ARE NECESSARY FOR CONSTRUCTION ACTIVITIES DURING RESERVOIR IMPROVEMENTS.
 - MAINTAIN ACCESS ROAD FOR USE OF PRIVATE RESIDENTS AT ALL TIMES.
 - ROAD TO THE SOUTH SHALL NOT BE USED TO ACCESS THE SITE.
 - INSTALL SAMPLE STATION ON COMMON FILL LINE IN EXISTING VALVE VAULT. FINAL LOCATION OF SAMPLE STATION SHALL BE DETERMINED IN THE FIELD BY THE ENGINEER. SEE DETAIL 4 ON SHEET M-7.
 - CONTRACTOR SHALL SWEEP HWY 219 AT THE INTERSECTION OF THE ACCESS ROAD DAILY. DO NOT TRACK MUD, DIRT OR DEBRIS ONTO HIGHWAY.

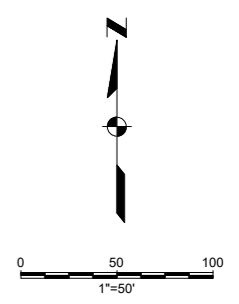
SURVEY CONTROL:

TOPOGRAPHIC SURVEY DATUM FOR VERTICAL CONTROL IS NAVD 88. HORIZONTAL CONTROL IS BASED ON NAD 83, OREGON STATE PLANE NORTH.

CP#1: PK NAIL
 N 617155.10
 E 7565937.40
 EL 386.17

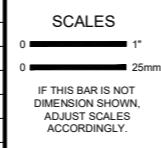
CP#2: PK NAIL
 N 617176.16
 E 7566157.68
 EL 396.88

CP#3: 5/8" IRON ROD
 N 617106.16
 E 7567007.16
 EL 378.65



RECORD DRAWINGS

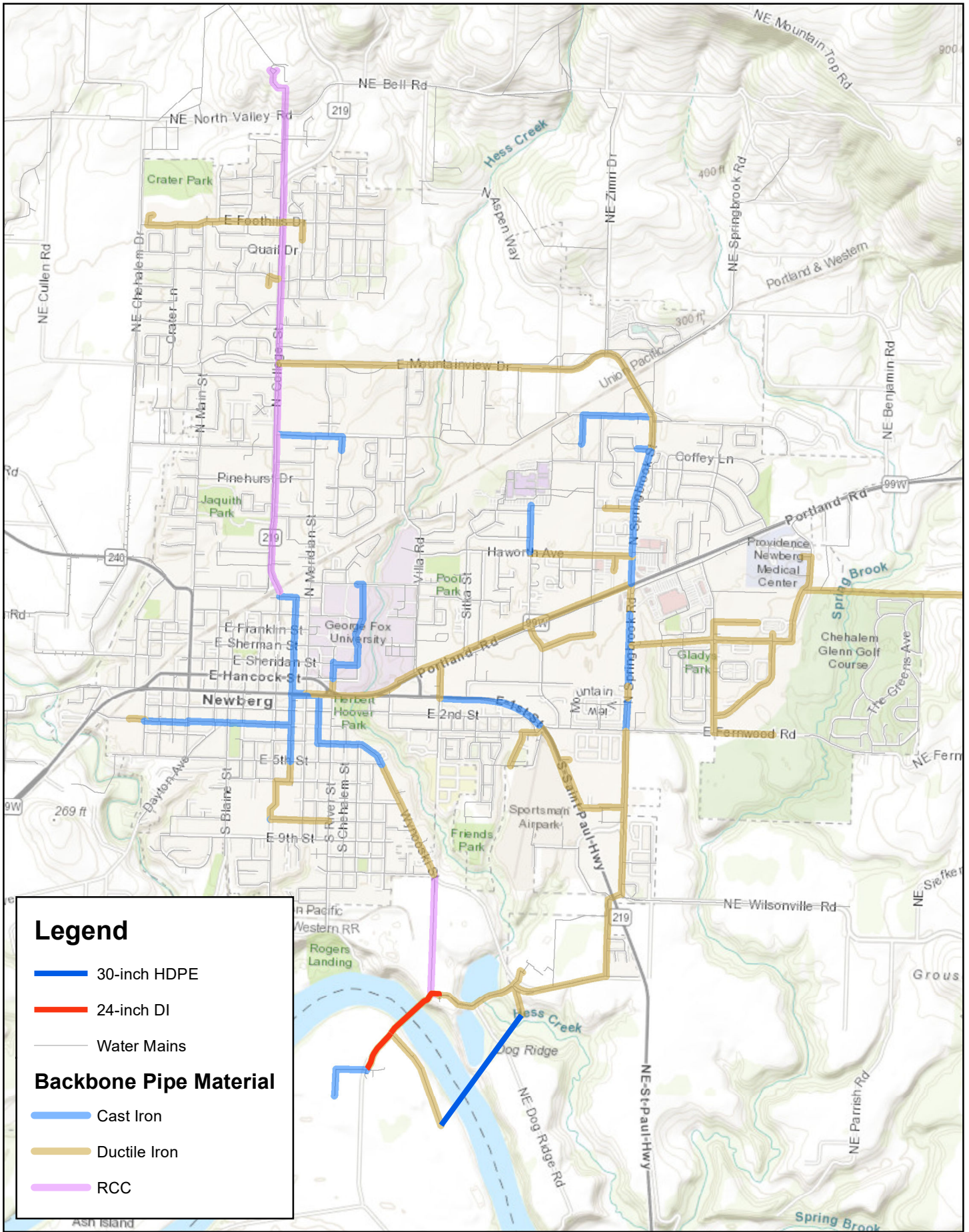
USE OF DOCUMENTS THIS DOCUMENT, INCLUDING THE INCORPORATED DESIGNS, IS AN INSTRUMENT OF SERVICE FOR THIS PROJECT AND SHALL NOT BE USED FOR ANY OTHER PROJECT WITHOUT THE WRITTEN AUTHORIZATION OF KENNEDY/JENKS CONSULTANTS ©.					DESIGNED SCS DRAWN SLG CHECKED MDL	CITY OF NEWBERG NEWBERG, OREGON NORTH VALLEY AND CORRAL CREEK RESERVOIRS SEISMIC UPGRADE AND INLET/OUTLET MODIFICATIONS Kennedy/Jenks Consultants® 200 SW MARKET STREET, SUITE 500, PORTLAND, OREGON 97201	NORTH VALLEY RESERVOIRS NO1 & NO2 - SITE & EROSION CONTROL PLAN	FILE NAME 1091031C01_REC.DWG
								JOB NO. 1091031.20
								DATE SEPTEMBER 2015
								SHEET OF C-1
	RECORD DRAWINGS	JAN 2017	SCS					
NO.	REVISION	DATE	BY					



THESE RECORD DRAWINGS HAVE BEEN PREPARED BASED ON INFORMATION PROVIDED BY THE CONTRACTOR AND OTHERS. KENNEDY/JENKS CONSULTANTS HAS NOT VERIFIED THE ACCURACY OR COMPLETENESS OF THE INFORMATION PROVIDED TO THEM AND DOES NOT WARRANT THE ACCURACY OR COMPLETENESS OF THESE RECORD DRAWINGS. USERS OF THESE RECORD DRAWINGS ASSUME ALL RISK OF LOSS RESULTING FROM THEIR USE.

Appendix C:

Mitigation Recommendation 3 – Backbone Pipeline Replacements



Legend

- 30-inch HDPE
- 24-inch DI
- Water Mains

Backbone Pipe Material

- Cast Iron
- Ductile Iron
- RCC



Appendix E: Recommendations for Future Studies



Memo

Date: Monday, June 22, 2020

Project: City of Newberg Seismic Resilience Assessment

To: Brett Musick, PE, City of Newberg

From: Andy McCaskill, P.E. and Katie Walker, P.E.

Subject: Seismic Resilience Assessment – Recommendations for Future Studies

Introduction

The City of Newberg (Newberg) operates a water system consisting of a wellfield, raw water transmission pipelines, a water treatment plant, three water storage reservoirs, one pump station, and distribution system pipelines. In support of the 2017 Water Master Plan and Oregon Health Authority (OHA) guidelines, Newberg conducted a water system seismic resilience assessment (SRA). The purpose of this memorandum is to identify the additional recommended studies to further clarify and confirm the City's seismic mitigation needs.

Future Studies

Seismic Recovery Goals

During workshops, alternative demand strategies were discussed, such as a potential influx of residents from coastal areas. Additional studies could be conducted to identify additional demands that impact the water storage available within the system.

Geotechnical

Additional geotechnical studies are recommended to better classify the seismic hazards that the water system components may experience. Targeted field investigations will allow Newberg to focus on the most hazardous areas. These include:

- Investigate vulnerabilities of the horizontal directional drill transmission main under the river. The soil conditions in the south side of the alignment indicate liquefaction induced settlement, especially at the transition to the well field piping.
- Impacts of seismic activity to the well field, well infrastructure, and groundwater. It is likely, based on the soil information available, that significant liquefaction and lateral spreading will occur during a CSZ earthquake. This could cause separation between the well casing and the pipe connection, plug the screens and reduce the capacity of the well, and fluctuation in the groundwater levels.
- Review the effects of bank erosion due to the Willamette River on slope stability in the proximity of the WTP.

Structural

The SRA included high level assessments of structural components within the City's water system. Depending on the desire to retrofit or rehabilitate the pipeline bridge, additional studies should be conducted to identify the mitigation measures needed to maintain the structure and the pipeline during a CSZ event. Likewise, additional investigations should be conducted at the WTP to identify specific mitigation measures for individual structural components.

Mitigation Strategies

As part of the SRA, only five mitigation strategies were identified. Additional improvements need to be identified and implemented to achieve the LOS goals. Additional mitigation strategies to investigate include:

- Wellfield infrastructure improvements based on the recommended additional geotechnical investigations.
- Improvements to the seismic resiliency of the transmission system main to address the potential for pipe separation.
- Improvements to slope stability at the WTP to prevent landslides.
- Installation of pipeline bridge isolation valves to minimize water loss if the bridge or pipeline fails.
- Construct a seismic resilient well with backup generator away from the river to replace well 4.
- Install seismic raw waterline from new seismic well to existing 30" HDPE line.
- Install a raw water booster pump station with a connection to potable water system.
- Investigate locations where seismic joints can be added to protect the water system.

Other Studies

- Develop new engineering standards to address seismic resiliency needs including those for the backbone system and updates to water service connections
- Review SCADA and GIS mapping system to see where improvements can be made with helpful alarms and feedback.
- Review fiber optic and power supply to identify vulnerabilities, and how the outage of those items would impact the water system.

**Exhibit “B” to Ordinance No. 2021-2876
Findings – File CPTA20-0003**

APPROVAL CRITERIA

A. Statewide Planning Goals (the “Goals”)

GOAL 1: CITIZEN INVOLVEMENT

To develop a citizen involvement program that ensures the opportunity for citizens to be involved in all phases of the planning process.

Finding: The City meets this requirement by having various citizen committees and/or commissions with opportunities for the public to testify on general or specific matters. For the Water Master Plan - Addendum Riverfront Master Plan 2021 it included a Citizen Advisory Committee that met two times, a work session was held with the City Council on April 5, 2021, went before the Newberg Planning Commission on April 8, 2021 and Newberg City Council on May 3, 2021, which provided the opportunity for public comment. Finally, notice was published in the Newberg Graphic newspaper and posted in four public places.

The amendment is subject to the Type IV Legislative process, which requires public notification and public hearings before the Planning Commission and the City Council. This process has been established by the City and determined to be consistent with Goal I of the Oregon Statewide Planning Goals. The public hearing notice of the action and decision, and the hearings on this case before the Planning Commission and the City Council are all recognized as opportunities for citizen participation.

The Goal is met.

GOAL 2: LAND USE PLANNING

To establish a land use planning process and policy framework as a basis for all decisions and actions related to use of land and to assure an adequate factual base for such decisions and actions.

Finding: This Goal requires that actions related to land use be consistent with acknowledged comprehensive plans of cities and counties. The City of Newberg last updated its Water Master Plan in 2017. The Addendum Riverfront Master Plan 2021 updates the 2017 Water Master Plan to implement the 2019 Riverfront Master Plan and will be incorporated by reference into the Newberg Comprehensive Plan as noted in Exhibit “C”.

Development of the 2017 Water Master Plan – Addendum Riverfront Master Plan 2021, Exhibit “A” and Exhibit “C” was based on an adequate factual base as documented in 2017 Water Master Plan – Addendum Riverfront Master Plan 2021. The 2019 Riverfront Master Plan evaluated alternative land use arrangements that were considered, and a Preferred Alternative was selected. Implementation measures in the proposed 2017 Water Master Plan – Addendum Riverfront Master Plan 2021 are consistent with and adequate to carry out relevant Comprehensive Plan policies and intended types of development for land use designations as noted in these findings, including the protection of natural and cultural resources.

The Goal is met.

GOAL 3: AGRICULTURAL LANDS

To preserve and maintain agricultural lands.

Finding: Not applicable because the proposal does not propose any land use regulation changes to agricultural lands outside of the Newberg Urban Growth Boundary.

GOAL 4: FOREST LANDS

To conserve forest lands by maintaining the forest land base and to protect the state's forest economy by making possible economically efficient forest practices that assure the continuous growing and harvesting of forest tree species as the leading use on forest land consistent with sound management of soil, air, water, and fish and wildlife resources and to provide for recreational opportunities and agriculture.

Finding: Not applicable because the proposal does not propose any land use regulation changes to the Stream Corridor that protects wooded areas within the Newberg Urban Growth Boundary.

GOAL 5: NATURAL RESOURCES, SCENIC AND HISTORIC AREAS, AND OPEN SPACES

To protect natural resources and conserve scenic and historic areas and open spaces.

Finding: The proposed amendments will not negatively impact inventoried Goal 5 resources because the amendments do not change protections that already exist in the Newberg Municipal Code to protect these resources. Newberg has an acknowledged Stream Corridor designation, inventoried historic resources, and identified open spaces in compliance with Goal 5.

This Goal is met.

GOAL 6: AIR, WATER AND LAND RESOURCES QUALITY

To maintain and improve the quality of the air, water and land resources of the state.

Finding: Goal 6 addresses the quality of air, water, and land resources. In the context of a comprehensive plan amendment, a local government complies with Goal 6 by explaining why it is reasonable to expect that the proposed uses authorized by the plan amendment will be able to satisfy applicable federal and state environmental standards, including air and water quality standards. The 2017 Water Master Plan – Addendum Riverfront Master Plan 2021 address the land use pattern and density consistent with the acknowledged Newberg Comprehensive Plan to ensure that air, water and land resource quality through efficient use of the land supply through the provision of wastewater facilities.

Newberg has an acknowledged Comprehensive Plan that complies with this goal. Protections are already in place for air, water, and land resource quality. This proposal does not modify the existing goals and policies.

This Goal is met.

GOAL 7: AREAS SUBJECT TO NATURAL HAZARDS

To protect people and property from natural hazards.

Finding: Newberg has an acknowledged Comprehensive Plan that complies with this goal. This proposal does not modify the City’s natural hazards requirements such as flood plain or landslide areas. This proposal does not modify the existing goals and policies.

This Goal is met.

GOAL 8: RECREATIONAL NEEDS

To satisfy the recreational needs of the citizens of the state and visitors and, where appropriate, to provide for the siting of necessary recreational facilities including destination resorts.

Finding: Newberg has an acknowledged Comprehensive Plan that complies with this goal. This proposal does not modify the City’s recreational goals and policies.

This Goal is met.

GOAL 9: ECONOMIC DEVELOPMENT

To provide adequate opportunities throughout the state for a variety of economic activities vital to the health, welfare, and prosperity of Oregon's citizens.

Finding: The 2017 Water Master Plan – Addendum Riverfront Master Plan 2021 provides for adequate water system for all residential, commercial, and industrial uses that are anticipated in the acknowledged Newberg Comprehensive Plan through the identification of necessary water system improvements based on projected population growth which will ensure a diverse and stable economic base of the community over the 20-year planning horizon. The update include a Water System Seismic Resilience Study to evaluate improvements in response to a Cascadia Subduction Zone earthquake to ensure the system could provide potable water residential, commercial, and industrial uses.

The 2019 Riverfront Master Plan proposal envisions the riverfront as an economically thriving area with a mix of residential, commercial, industrial, and employment uses and enhanced transportation connections between the Riverfront and Newberg’s downtown. The adopted changes to the Comprehensive Plan and Map included a new mixed use area on the Riverfront Mill Site that is intended to provide a flexible mix of light industrial and employment uses that will support the City’s diverse employment opportunities. The 2017 Water Master Plan – Addendum Riverfront Master Plan 2021 ensures an adequate water system to support economic activities.

This Goal is met.

GOAL 10: HOUSING

To provide for the housing needs of citizens of the state.

Finding: The 2019 Riverfront Master Plan proposal envisions the riverfront as an economically thriving area with a mix of residential, commercial, industrial, and employment uses and enhanced transportation connections between the Riverfront and Newberg’s downtown. The adopted changes to the Comprehensive Plan and Map included as part of CPTA20-0001/CPMA20-0002/DCA20-0001/ZMA20-0002 increased medium- and high-density residential areas to provide more opportunities for affordable and work-force housing. The Comprehensive Plan changes in CPTA20-0001/CPMA20-0002/DCA20-0001/ZMA20-0002 recognized the following residential analysis.

In the CPTA Housing Land Needs and Buildable Land Supply Analysis:

Newberg’s Comprehensive Plan shows a need for additional MDR (Medium Density Residential) and COM (Commercial) land. In 2005, the City Council adopted amendments to the Comprehensive Plan, including updated residential land need and supply numbers for LDR (Low Density Residential), MDR (Medium Density Residential) and HDR (High Density Residential) land designations. The updates were based on data from the Housing and Residential Land Needs Report compiled by Johnson-Gardner in 2004. The amendments were adopted and acknowledged through the post-acknowledgment plan amendment process in 2005. The 2005 Comprehensive Plan has residential land data for the 20-year period from 2005-2025, and the future planning period out to 2040. This data shows that the City had a demonstrated need for 173 buildable acres of MDR (Medium Density Residential) through 2025, and an additional 191 acres of HDR land through 2040 (see table below). Buildable land includes vacant and redevelopable land in the existing Urban Growth Boundary (UGB).

Newberg Comprehensive Plan, Table V-7 Buildable Residential Land Needs vs. Supply				
Plan Designation	Buildable Acres Needed 2005-2025	Buildable Acres in UGB (2004)	Surplus (Deficit) for 2005-2025	Buildable Acres Needed 2026-2040
LDR	612	359	(253)	735
MDR	173	142	(31)	191
HDR	89	13	(76)	83
Total	874	514	(380)	1009

In 2009 the City proposed an update to the Housing Element of the Comprehensive Plan. This item was appealed to LUBA and remanded; it has not yet been revised and readopted, so the 2005 amendments are the latest acknowledged estimates. A preliminary Buildable Lands Inventory (BLI) was completed for the City in 2016 utilizing the Simplified Method for Urban Growth Boundary (UGB) expansion; however, the BLI has not been finalized because several issues with the methodology were identified by the consultant and City staff.

Since 2015 there have been six Comprehensive Plan Map amendments including:

- CPA-15-001/ZMA3-15-001 – Martell Commons – 5.91 acres going from LDR to HDR
- CPMA18-0001/ZMA18-0002 – 1109 S River Street – 1.33 acres going from LDR to HDR
- CPMA18-0005/ZMA18-0002 – 501 and 507 E Illinois Street – 2.87 acres going from MDR to HDR
- CPMA18-0006 – 1303 S River Street (Riverlands) – 1.56 acres going from COM to MDR
- CPMA19-0001/ZMA19-0001 – 502 S St. Paul Highway (Beaudry) – 1.11 acres going from MDR to IND
- CPMA20-0001/ZMA20-0001 - 717 N College Street - .08 acres from LDR to MDR and .49 acres from COM to MDR

The above changes to HDR, MDR, and IND acreage are utilized along with additional data found within the staff reports from these previous comprehensive plan updates to update the 2005 buildable lands data.

Data was drawn from the six previous comprehensive plan map and zoning map amendments. Below is the population excerpt for the next 20 years as provided by Portland State University’s Population Research Center. As illustrated below, the City of Newberg 2020 estimated population is 24,877 and is estimated to grow by 17,500 to a total of 42,377. The projected increase in population indicates a continued need for additional residential housing.

Table 1: Population Forecast 2020-2060

City	2020	2025	2030	2035	2040	2045	2050	2055	2060
Newberg	24,877	26,557	28,432	30,576	32,780	34,929	37,247	39,907	42,377
Change		+1,680	+1,857	+2,144	+2,204	+2,149	+2,318	+2,660	+2,470
% Increase		6.7%	6.9%	7.5%	7.2%	6.5%	6.6%	7.1%	6.1%

Source: Population Research Center, Portland State University, March 31, 2020. Proposed forecasts represent populations as of July 1 of each year

Table 2: Buildable Residential Needs vs. Supply after Proposed Comp Plan Change 2020-2035

Land Designation	Buildable Acres Needed	Buildable Acres Before Comp Plan Change	Building Acres After Comp Plan Change	Surplus/(Deficit) Before Comp Plan Change	Surplus/(Deficit) After Comp Plan Change
LDR	301	385	384.91	84	83.91
MDR	132	81.57	82.64	(50.43)	(49.36)
HDR	46	9	12.7	(37)	(33.33)
Total	479	475.57	480.25	(3.43)	(8.78)

Table 2 utilizes the data from the six comprehensive map amendments and the Riverfront Master Plan amendment (CPMA20-0002/ZMA20-0002), due to this data being the most up-to-date for residential buildable land. As illustrated in Table 2 there is a deficit of 49.36 acres of MDR and 33.33 acres of HDR land after the adoption of the Riverfront Master Plan amendment. This does not take into consideration the COM/RD designation which will allow mixed commercial with commercial activities on the ground floor and residential above. There is no density minimum or maximum for residential on the COM/RD designation above the ground floor which needs to be commercial. Exhibit “A” provides additional information on the uses. Overall the Riverfront area proposed residential designations increased the number of potential residential units.

The above analysis is based on the 2005 Housing Needs Analysis (HNA). In 2021 the City Council accepted the 2021 HNA (it was not officially adopted as a precursor to a potential UGB expansion). The 2021 HNA identified an overall deficiency of 81 acres (37 acres MDR, and 44 acres of HDR) of residential land.

Efficient development of residentially zoned land located within the City can provide the opportunity for additional housing to meet the needs of the citizens of Newberg. The Comprehensive Plan and Development Code amendments to implement the Riverfront Master Plan create the opportunity for a mix of housing types within the Riverfront Master Plan area. This will provide flexibility to accommodate a variety of housing types including those that can be utilized for affordable housing and rental housing and complies with the goal.

Amending the Comprehensive Plan – 2017 Water Master Plan – Addendum Riverfront Master Plan 2021 reflects the intent of the Riverfront Master Plan that includes the following land use elements:

- Riverfront Industrial
- Riverfront Commercial
- Mixed Employment
- Community Facilities
- Residential (R-2 & R-3)

In addition to this analysis the Riverfront Master Plan included the following data on residential development.

Appendix B: Estimates of Residential Capacity within Land Use Alternatives
 UPDATED 8/12/2019 to include Updates to Alternative E

<i>Alternative E</i>				
Land Use	Acres	Existing Residential Units	New Residential Units	Total Residential Units
<i>Medium Density Residential*</i>	92.2	459	227	686
<i>High Density Residential*</i>	25.1	221	67	288
<i>Mixed Commercial**</i>	7.6	N/A	45	45
<i>Mixed Employment</i>	21.5	N/A	N/A	N/A
<i>Industrial</i>	94.5	N/A	N/A	N/A
<i>Parks & Open Spaces</i>	164.5	N/A	N/A	N/A
TOTAL	396	680	339	1,019

**New residential units calculated based on the following current zoning regulations:*

- *MDR: R-2, averaging 9 units/gross acre*
- *HDR: R-3, averaging 16.5 units/gross acre*

***New residential Units for Mixed Commercial calculated as 1/3 of total acres based on HDR density of 16.5 units/gross acre*

Of the units estimated in MDR in the above calculation is a 132 lot detached single family residential subdivision for which 19 building permits have been issued and homes are under construction. A 45 unit apartment project in HDR is under construction that was included in the Existing Residential Units calculation. The adopted CPMA20-0002/ZMA20-0002 per Ordinance No. 2020-2868 captured the future new MDR (227-132=95) 95 units, HDR residential units of 67 and the Mixed Commercial residential units of 45.

The 2017 Water Master Plan – Addendum Riverfront Master Plan 2021 ensures an adequate water system to support the future housing within the Riverfront Master Plan area.

The Goal is met.

GOAL 11: PUBLIC FACILITIES AND SERVICES

To plan and develop a timely, orderly and efficient arrangement of public facilities and services to serve as a framework for urban and rural development.

Finding: The 2017 Water Master Plan – Addendum Riverfront Master Plan 2021 outlines the provision of the City of Newberg’s water system for treatment, distribution, and capital improvement program as identified in Exhibit “A”. The plan lays out the necessary improvements for the system and extension of the water system to service all lands within the Newberg Urban Growth Boundary and Riverfront Master Plan area in a timely, orderly and efficient arrangement for urban development.

This Goal is met.

GOAL 12: TRANSPORTATION

To provide and encourage a safe, convenient and economic transportation system.

Finding: Not applicable because the proposal does not address a transportation system.

GOAL 13: ENERGY CONSERVATION

To conserve energy.

Finding: The 2017 Water Master Plan – Addendum Riverfront Master Plan 2021 has taken into consideration the acknowledged Newberg Comprehensive Plan and the Population Forecasts for Newberg prepared by Portland State University in June 2017 to provide an energy efficient treatment and distribution system of the water system within the Newberg Urban Growth Boundary and Riverfront Master Plan area.

This Goal is met.

GOAL 14: URBANIZATION

To provide for an orderly and efficient transition from rural to urban land use, to accommodate urban population and urban employment inside urban growth boundaries, to ensure efficient use of land, and to provide for livable communities.

Finding: The proposed amendments do not include an expansion of the Urban Growth Boundary. There are properties within the Riverfront Master Plan area that are not annexed into the city limits but are within the Urban Growth Boundary. Annexation of these properties will be critical to providing needed

water infrastructure and realizing the development vision for the area. Development of the Riverfront area will maintain Newberg's identity and enhance the quality living environment by balancing growth and providing cultural activities.

This Goal is met.

GOAL 15: WILLAMETTE RIVER GREENWAY

To protect, conserve, enhance and maintain the natural, scenic, historical, agricultural, economic and recreational qualities of lands along the Willamette River as the Willamette River Greenway.

Finding: Not applicable because the proposal does not propose any land use regulation changes to the Willamette River Greenway.

This Goal is met.

B. Newberg Comprehensive Plan

II. GOALS AND POLICIES

A. CITIZEN INVOLVEMENT

GOAL: To maintain a Citizen Involvement Program that offers citizens the opportunity for involvement in all phases of the planning process.

Finding: The City meets this requirement by having various citizen committees and/or commissions with opportunities for the public to testify on general or specific matters. For the Water Master Plan - Addendum Riverfront Master Plan 2021 it included a Citizen Advisory Committee that met two times, a work session was held with the City Council on April 5, 2021, went before the Newberg Planning Commission on April 8, 2021 and Newberg City Council on May 3, 2021, which provided the opportunity for public comment. Finally, notice was published in the Newberg Graphic newspaper and posted in four public places.

The amendment is subject to the Type IV Legislative process, which requires public notification and public hearings before the Planning Commission and the City Council. This process has been established by the City and determined to be consistent with Goal I of the Oregon Statewide Planning Goals. The public hearing notice of the action and decision, and the hearings on this case before the Planning Commission and the City Council are all recognized as opportunities for citizen participation.

The Goal is met.

B. LAND USE PLANNING

GOAL: To maintain an on-going land use planning program to implement statewide and local goals. The program shall be consistent with natural and cultural resources and needs.

POLICY: 2. The Comprehensive Plan and implementing ordinances shall be reviewed continually and revised as needed. Major reviews shall be conducted during the State periodic review process.

Finding: This Goal requires that actions related to land use be consistent with acknowledged comprehensive plans of cities and counties. The City of Newberg last updated its Water Master Plan in 2017. The Addendum Riverfront Master Plan 2021 updates the 2017 Water Master Plan to implement the 2019 Riverfront Master Plan and will be incorporated by reference into the Newberg Comprehensive Plan as noted in Exhibit “C”.

Development of the 2017 Water Plan – Addendum Riverfront Master Plan 2021, Exhibit “A” was based on an adequate factual base as documented in 2017 Water Plan – Addendum Riverfront Master Plan 2021. The 2019 Riverfront Master Plan evaluated alternative land use arrangements that were considered, and a Preferred Alternative was selected. Implementation measures in the proposed 2017 Water Master Plan – Addendum Riverfront Master Plan 2021 are consistent with and adequate to carry out relevant Comprehensive Plan policies and intended types of development for land use designations as noted in these findings, including the protection of natural and cultural resources.

The proposed amendment to the Comprehensive Plan and Development Code comply with this Goal.

C. AGRICULTURAL LANDS

GOAL: To provide for the orderly and efficient transition from rural to urban land uses.

Finding: Not applicable because the proposal does not propose any land use regulation changes to agricultural lands outside of the Newberg Urban Growth Boundary.

D. WOODED AREAS

GOAL: To retain and protect wooded areas.

Finding: Not applicable because the proposal does not propose any land use regulation changes to the Stream Corridor that protects wooded areas within the Newberg Urban Growth Boundary.

E. AIR, WATER, AND LAND RESOURCE QUALITY

GOAL: To maintain and, where feasible, enhance the air, water and land resource qualities within the community.

POLICY: 1. Development shall not exceed the carrying capacity of the air, water or land resource base.

Finding: Newberg has an acknowledged Comprehensive Plan that complies with this goal. Protections are already in place for air, water, and land resource quality. The population forecast information will be used to assist in evaluating future land use planning efforts on the carrying capacity of the air, water or land resource base. This proposal does not modify the existing goals and policies.

This Goal is met.

F. AREAS SUBJECT TO NATURAL HAZARDS

GOAL: To protect life and property from flooding and other natural hazards.

Finding: Newberg has an acknowledged Comprehensive Plan that complies with this goal. This proposal does not modify the City's natural hazards requirements such as flood plain or landslide areas. This proposal does not modify the existing goals and policies.

This Goal is met.

G. OPEN SPACE, SCENIC, NATURAL, HISTORIC AND RECREATIONAL RESOURCES

GOALS:

1. To ensure that adequate land shall be retained in permanent open space use and that natural, scenic and historic resources are protected.
2. To provide adequate recreational resources and opportunities for the citizens of the community and visitors.
3. To protect, conserve, enhance and maintain the Willamette River Greenway.

Finding: Newberg has an acknowledged Comprehensive Plan that complies with this goal. This proposal does not modify the City's recreational needs goals and policies. The population forecast information will be used to assist in evaluating future land use planning efforts related to open space, scenic historic and recreational resources.

These Goals are met.

H. THE ECONOMY

GOAL: To develop a diverse and stable economic base.

POLICY: 1. General Policies. b. The City shall encourage economic expansion consistent with local needs.

Finding: The 2017 Water Master Plan – Addendum Riverfront Master Plan 2021 provides for adequate water service provision for all residential, commercial, industrial and institutional uses that are anticipated in the acknowledged Newberg Comprehensive Plan through the identification of necessary water system improvements based on projected population growth which will ensure a diverse and stable economic base of the community over the 20-year planning horizon. The update include a Water System Seismic Resilience Study to evaluate improvements in response to a Cascadia Subduction Zone earthquake to ensure the system could provide potable water residential, commercial, and industrial uses.

The 2019 Riverfront Master Plan proposal envisions the riverfront as an economically thriving area with a mix of residential, commercial, industrial, and employment uses and enhanced transportation connections between the Riverfront and Newberg’s downtown. The adopted changes to the Comprehensive Plan and Map included a new mixed use area on the Riverfront Mill Site that is intended to provide a flexible mix of light industrial and employment uses that will support the City’s diverse employment opportunities. The 2017 Water Master Plan – Addendum Riverfront Master Plan 2021 ensures an adequate water system to support economic activities.

This Goal is met.

I. HOUSING

GOAL: To provide for diversity in the type, density and location of housing within the City to ensure there is an adequate supply of affordable housing units to meet the needs of City residents of various income levels.

Finding: The 2019 Riverfront Master Plan proposal envisions the riverfront as an economically thriving area with a mix of residential, commercial, industrial, and employment uses and enhanced water system. The adopted changes to the Comprehensive Plan and Map included as part of CPTA20-0001/CPMA20-0002/DCA20-0001/ZMA20-0002 increased medium- and high-density residential areas to provide more opportunities for affordable and workforce housing. The analysis above under A. Statewide Planning Goals (the “Goals”), GOAL 10: HOUSING, To provide for the housing needs of citizens of the state, details how the proposed 2017 Water Master Plan – Addendum Riverfront Master Plan 2021 amendment ensures an adequate water system to support housing.

J. URBAN DESIGN

GOAL 1: To maintain and improve the natural beauty and visual character of the City.

GOAL 2: To develop and maintain the physical context needed to support the livability and unique character of Newberg.

Finding: Not applicable because the proposal does not propose any land use regulation changes to urban design policies or regulations.

K. TRANSPORTATION

GOAL 1: Establish cooperative agreements to address transportation based planning, development, operation and maintenance.

GOAL 2: Establish consistent policies which require concurrent consideration of transportation/land use system impacts.

GOAL 3: Promote reliance on multiple modes of transportation and reduce reliance on the automobile.

GOAL 4: Minimize the impact of regional traffic on the local transportation system.

GOAL 5: Maximize pedestrian, bicycle and other non-motorized travel throughout the City.

GOAL 6: Provide effective levels of non-auto oriented support facilities (e.g. bus shelters, bicycle racks, etc.).

GOAL 7: Minimize the capital improvement and community costs to implement the transportation plan.

GOAL 8: Maintain and enhance the City's image, character and quality of life.

GOAL 9: Create effective circulation and access for the local transportation system.

GOAL 10: Maintain the viability of existing rail, water and air transportation systems.

GOAL 11: Establish fair and equitable distribution of transportation improvement costs.

GOAL 12: Minimize the negative impact of a Highway 99 bypass on the Newberg community.

GOAL 13: Utilize the Yamhill County Transit Authority (YCTA) Transit Development Plan (TDP) as a Guidance Document.

GOAL 14: Coordinate with Yamhill County Transit Area.

GOAL 15: Implement Transit-Supportive Improvements.

Finding: No applicable because the proposal does not address a transportation system.

L. PUBLIC FACILITIES AND SERVICES

GOAL: To plan and develop a timely, orderly and efficient arrangement of public facilities and services to serve as a framework for urban development.

Finding: The 2017 Water Master Plan – Addendum Riverfront Master Plan 2021 outlines the provision of the City of Newberg’s wastewater system for conveyance, treatment, and capital improvement program as identified in Exhibit “A”. The plan lays out the necessary improvements for the system and extension of the water system to service all lands within the Newberg Urban Growth Boundary and Riverfront Master Plan area in a timely, orderly and efficient arrangement for urban development.

This Goal is met.

M. ENERGY

GOAL: To conserve energy through efficient land use patterns and energy- related policies and ordinances.

Finding: The 2017 Water Master Plan – Addendum Riverfront Master Plan 2021 has taken into consideration the acknowledged Newberg Comprehensive Plan and the Population Forecasts for Newberg prepared by Portland State University in June 2017 to provide an energy efficient conveyance and treatment of the wastewater system within the Newberg Urban Growth Boundary.

This Goal is met.

N. URBANIZATION

GOALS:

1. To provide for the orderly and efficient transition from rural to urban land uses.
2. To maintain Newberg's identity as a community which is separate from the Portland Metropolitan area.
3. To create a quality living environment through a balanced growth of urban and cultural activities.

Finding: The proposed amendments do not include an expansion of the Urban Growth Boundary. There are properties within the Riverfront Master Plan area that are not annexed into the city limits but are within the Urban Growth Boundary. Annexation of these properties will be critical to providing needed water system and realizing the development vision for the area. Development of the Riverfront area will maintain Newberg's identity and enhance the quality living environment by balancing growth and providing cultural activities.

These Goals are met.

C. Oregon Revised Statutes and Oregon Administrative Rules

Applicable Oregon Revised Statute

197.712 Commission duties; comprehensive plan provisions; public facility plans; state agency coordination plans; compliance deadline; rules.

(2) By the adoption of new goals or rules, or the application, interpretation or amendment of existing goals or rules, the Land Conservation and Development Commission shall implement all of the following:

(e) A city or county shall develop and adopt a public facility plan for areas within an urban growth boundary containing a population greater than 2,500 persons. The public facility plan shall include rough cost estimates for public projects needed to provide sewer, water and transportation for the land uses contemplated in the comprehensive plan and land use regulations. Project timing and financing provisions of public facility plans shall not be considered land use decisions.

Finding: The 2017 Water Master Plan – Addendum Riverfront Master Plan 2021 is an element of the City of Newberg public facility plan covering the Urban Growth Boundary of the City and updates the 2017 Water Master Plan. The City of Newberg population is 24,120 which is larger than the baseline population requirement to have a public facilities plan. The 2017 Water Master Plan – Addendum Riverfront Master Plan 2021 includes cost estimates for infrastructure improvements based on the land uses contemplated in the comprehensive plan and land use regulations and meets the requirement.

Applicable Oregon Administrative Rules (OARs)

OAR Chapter 660, Division 11 Public Facilities Planning

OAR 660-011-0000

Purpose

The purpose of this division is to aid in achieving the requirements of Goal 11, Public Facilities and Services, OAR 660-015-0000(11), interpret Goal 11 requirements regarding public facilities and services on rural lands, and implement ORS 197.712(2)(e), which requires that a city or county shall develop and adopt a public facility plan for areas within an urban growth boundary containing a population greater than 2,500 persons. The purpose of the plan is to help assure that urban development in such urban growth boundaries is guided and supported by types and levels of urban facilities and services appropriate for the needs and requirements of the urban areas to be serviced, and that those facilities and services are provided in a timely, orderly and efficient arrangement, as required by Goal 11. The division contains definitions relating to a public facility plan, procedures and standards for developing, adopting, and amending such a plan, the date for submittal of the plan to the Commission and standards for Department review of the plan.

Finding: The City of Newberg is a community of 24,120 individuals with an acknowledged Comprehensive Plan and Urban Growth Boundary. Because the population is greater than 2,500 Newberg is required to have an adopted public facility plan (Water Master Plan). The City of Newberg currently has a 2017 Water Master Plan which is proposed to be updated by the 2017 Water Master Plan – Addendum Riverfront Master Plan 2021 to assure that urban development in the Urban Growth Boundary is guided and supported by types and levels of urban facilities and services appropriate for the needs and requirements of the urban area to be serviced, and that water facilities are provided in a

timely, orderly and efficient arrangement. The proposed 2017 Water Master Plan – Addendum Riverfront Master Plan 2021 is consistent with the Purpose of OAR 660-011-0000.

OAR 660-011-0005

Definitions

(1) "Public Facilities Plan": A public facility plan is a support document or documents to a comprehensive plan. The facility plan describes the water, sewer and transportation facilities which are to support the land uses designated in the appropriate acknowledged comprehensive plans within an urban growth boundary containing a population greater than 2,500. Certain elements of the public facility plan also shall be adopted as part of the comprehensive plan, as specified in OAR 660-11-045.

Finding: The City of Newberg population forecast as of July 2017, as determined by Portland State University Population Research Center, was 23,480. The 2020 Portland State University Population Research Center estimate was 24,120. The 2017 Water Master Plan – Addendum Riverfront Master Plan 2021 is being adopted as a support document and as part of the Newberg Comprehensive Plan. The 2017 Water Master Plan – Addendum Riverfront Master Plan 2021 supports the land use designations in the acknowledged Newberg Comprehensive Plan which covers the Newberg Urban Growth Boundary. The 2017 Water Master Plan – Addendum Riverfront Master Plan 2021 as part of the overall Public Facilities Plan meets the definition of OAR 660-011-0005(1).

(2) "Rough Cost Estimates": Rough cost estimates are approximate costs expressed in current-year (year closest to the period of public facility plan development) dollars. It is not intended that project cost estimates be as exact as is required for budgeting purposes.

Finding: The 2017 Water Master Plan – Addendum Riverfront Master Plan 2021, Exhibit “A”, contains cost estimates as noted under OAR 660-011-0010 and meets the definition.

(3) "Short Term": The short term is the period from year one through year five of the facility plan.

Finding: The 2017 Water Master Plan – Addendum Riverfront Master Plan 2021, Exhibit “A”, contains a short term horizon of Priority 1 projects covering the first 5 years consistent with the definition of OAR 660-011-0005(3).

(4) "Long Term": The long term is the period from year six through the remainder of the planning period.

Finding: The 2017 Water Master Plan – Addendum Riverfront Master Plan 2021, Exhibit “A”, contains a long term horizon of six years to the end of the planning horizon of 20-years consistent with the definition of OAR 660-011-0005(3).

(5) "Public Facility": A public facility includes water, sewer, and transportation facilities, but does not include buildings, structures or equipment incidental to the direct operation of those facilities.

Finding: The 2017 Water Master Plan – Addendum Riverfront Master Plan 2021, Exhibit “A”, is a public facility per the definition of OAR 660-011-0005(5).

(6) "Public Facility Project": A public facility project is the construction or reconstruction of a water, sewer, or transportation facility within a public facility system that is funded or utilized by members of the general public.

Finding: The 2017 Water Master Plan – Addendum Riverfront Master Plan 2021, Exhibit “A”, contains identified projects per the definition of OAR 660-011-0005(6).

(7) "Public Facility Systems": Public facility systems are those facilities of a particular type that combine to provide water, sewer or transportation services.

For purposes of this division, public facility systems are limited to the following:

(a)Water:

(A) Sources of water;

(B) Treatment system;

(C) Storage system;

(D) Pumping system;

(E) Primary distribution system.

Finding: The 2017 Water Master Plan – Addendum Riverfront Master Plan 2021, Exhibit “A”, is a part of the Public Facility System and includes the required elements of OAR 660-011-0005(7)(b)

(b) Sanitary sewer:

(A) Treatment facilities system;

(B) Primary collection system.

Finding: The 2017 Water Master Plan – Addendum Riverfront Master Plan 2021 is not a Sanitary Sewer Plan and does not apply.

(c) Storm sewer

(A) Major drainageways (major trunk lines, streams, ditches, pump stations and retention basins);

(B) Outfall locations.

Finding: The 2017 Water Master Plan – Addendum Riverfront Master Plan 2021 is not a Storm Sewer Plan and does not apply.

(d) Transportation:

(A) Freeway system, if planned for in the acknowledged comprehensive plan;

(B) Arterial system;

(C) Significant collector system;

(D) Bridge system (those on the Federal Bridge Inventory);

(E) Mass transit facilities if planned for in the acknowledged comprehensive plan, including purchase of new buses if total fleet is less than 200 buses, rail lines or transit stations associated with providing transit service to major transportation corridors and park and ride station;

(F) Airport facilities as identified in the current airport master plans;

(G) Bicycle paths if planned for in the acknowledged comprehensive plan.

Finding: The 2017 Water Master Plan – Addendum Riverfront Master Plan 2021 is not a Transportation Plan and does not apply.

(8) "Land Use Decisions": In accordance with ORS 197.712(2)(e), project timing and financing provisions of public facility plans shall not be considered land use decisions as specified under ORS 197.015(10).

Finding: The City of Newberg has a rolling Five Year Capital Improvement Program that addresses project timing and financing and is not considered a land use decision per OAR 660-011-0005(8). The Five Year Capital Improvement Program for water is included as Exhibit “B”, Attachment 2.

(9) "Urban Growth Management Agreement": In accordance with OAR 660-003-0010(2)(c), and urban growth management agreement is a written statement, agreement or set of agreements setting forth the means by which a plan for management of the unincorporated area within the urban growth boundary will be completed and by which the urban growth boundary may be modified (unless the same information is incorporated in other acknowledged documents).

Finding: The City of Newberg has a Newberg Urban Area Growth Management Agreement with Yamhill County that was initially adopted in 1979 (as amended) that is an agreement on the management of the unincorporated area within the Newberg Urban Growth Boundary and contains requirements on how the Urban Growth Boundary may be modified consistent with the definition in OAR 660-011-0005(9). This Agreement is included as Exhibit “B”, Attachment 1.

OAR 660-011-0010

The Public Facility Plan

(1) The public facility plan shall contain the following items:

(a) An inventory and general assessment of the condition of all the significant public facility systems which support the land uses designated in the acknowledged comprehensive plan;

Finding: The 2017 Water Master Plan – Addendum Riverfront Master Plan 2021, Exhibit “A”, includes

an assessment of the condition of the overall water system that supports the designated uses in the acknowledged Newberg Comprehensive Plan and meets the requirement.

(b) A list of the significant public facility projects which are to support the land uses designated in the acknowledged comprehensive plan. Public facility project descriptions or specifications of these projects as necessary;

Finding: The 2017 Water Master Plan – Addendum Riverfront Master Plan 2021, Exhibit “A”, Table 7-5, page 7-15 and Appendix E Table 8, page 18 of 19 identifies the priority projects with descriptions to support the estimated population and land uses identified in the acknowledged Newberg Comprehensive Plan and meets the requirement.

(c) Rough cost estimates of each public facility project;

Finding: The 2017 Water Master Plan – Addendum Riverfront Master Plan 2021, Exhibit “A”, page 7-15, Table 7-5 and Appendix E Table 8, page 18 of 19 provides costs estimates for projects as noted in Table 7-5 and Table 8 and meets the requirement.

(d) A map or written description of each public facility project's general location or service area;

Finding: The 2017 Water Master Plan – Addendum Riverfront Master Plan 2021, Exhibit “A”, contains descriptions and maps of the public facility projects and meets the requirement.

(e) Policy statement(s) or urban growth management agreement identifying the provider of each public facility system. If there is more than one provider with the authority to provide the system within the area covered by the public facility plan, then the provider of each project shall be designated;

Finding: The 2017 Water Master Plan – Addendum Riverfront Master Plan 2021, Exhibit “A”, identifies that the City of Newberg is the water service provider within the city limits and as annexations occur to lands within the Urban Growth Boundary. This is consistent with the Newberg Urban Area Growth Management Agreement included as Exhibit “B”, Attachment 1 and meets the requirement.

(f) An estimate of when each facility project will be needed; and

Finding: The 2017 Water Master Plan – Addendum Riverfront Master Plan 2021, Exhibit “A”, Table 7-5, page 7-15 and Appendix E Table 8, page 18 of 19 includes an estimate of the time horizons of when water system capital improvements are estimated to occur. This is broken out in the horizons of Priority 1 projects (1-5 years) and long term projects (Priority 6-20 years) which meets the requirement.

(g) A discussion of the provider's existing funding mechanisms and the ability of these and possible new mechanisms to fund the development of each public facility project or system.

Finding: The 2017 Water Master Plan – Addendum Riverfront Master Plan 2021, Exhibit “A”, Table 7-5, page 7-15 and Appendix E Table 8, page 18 of 19 identifies the proposed capital improvement projects, costs and funding mechanisms and meets the requirement.

(2) Those public facilities to be addressed in the plan shall include, but need not be limited to those specified in OAR 660-011-0005(5). Facilities included in the public facility plan other than those

included in OAR 660-011-0005(5) will not be reviewed for compliance with this rule.

Finding: OAR 660-011-0005(5)(c) identifies water and its subsets of sources of water, treatment system, storage system, pumping system, and primary distribution system. The 2017 Water Master Plan – Addendum Riverfront Master Plan 2021 addresses these components as noted in Exhibit “A” and meets the requirement.

(3) It is not the purpose of this division to cause duplication of or to supplant existing applicable facility plans and programs. Where all or part of an acknowledged comprehensive plan, facility master plan either of the local jurisdiction or appropriate special district, capital improvement program, regional functional plan, similar plan or any combination of such plans meets all or some of the requirements of this division, those plans, or programs may be incorporated by reference into the public facility plan required by this division. Only those referenced portions of such documents shall be considered to be a part of the public facility plan and shall be subject to the administrative procedures of this division and ORS Chapter 197.

Finding: The City of Newberg is proposing to update the existing water system master plans and adopt the 2017 Water Master Plan – Addendum Riverfront Master Plan 2021. Other than the proposed Water Capital Improvement Plan included as Exhibit “A” no other special district or regional functional plan is being referenced or is applicable.

OAR 660-011-0015

Responsibility for Public Facility Plan Preparation

(1) Responsibility for the preparation, adoption and amendment of the public facility plan shall be specified within the urban growth management agreement. If the urban growth management agreement does not make provision for this responsibility, the agreement shall be amended to do so prior to the preparation of the public facility plan. In the case where an unincorporated area exists within the Portland Metropolitan Urban Growth Boundary which is not contained within the boundary of an approved urban planning area agreement with the County, the County shall be the responsible agency for preparation of the facility plan for that unincorporated area. The urban growth management agreement shall be submitted with the public facility plan as specified in OAR 660-011-0040.

Finding: The Newberg Urban Area Growth Management Agreement, Exhibit “B”, Attachment 1, Section V. Urban Services identifies the City of Newberg as the ultimate provider of urban services within the Urban Growth Boundary and specifically notes that service expansion plans are the responsibility of the City of Newberg, which meets the requirement of OAR 660-011-0015.

(2) The jurisdiction responsible for the preparation of the public facility plan shall provide for the coordination of such preparation with the city, county, special districts and, as necessary, state and federal agencies and private providers of public facilities. The Metropolitan Service District is responsible for public facility plans coordination within the District consistent with ORS 197.190 and 268.390.

Finding: The 2017 Water Master Plan – Addendum Riverfront Master Plan 2021, Exhibit “A”, has been coordinated with Yamhill County. No other service providers are responsible for water service provisions within the Newberg Urban Growth Boundary, which meets the requirement of OAR 660-011-

0015(2). As part of the Post Acknowledgement Plan Amendment process through the Oregon Department of Land Conservation and Development and other State agencies that have an interest in Newberg’s Water Master Plan will be notified to be in compliance with OAR Chapter 333, Division 61.

(3) Special districts, including port districts, shall assist in the development of the public facility plan for those facilities they provide. Special districts may object to that portion of the facilities plan adopted as part of the comprehensive plan during review by the Commission only if they have completed a special district agreement as specified under ORS 197.185 and 197.254(3) and (4) and participated in the development of such portion of the public facility plan.

Finding: Chehalem Park and Recreation District provides park and trail system development within the Riverfront Master Plan area. The Chehalem Park and Recreation District participated in the preparation of the Riverfront Master Plan and preparation of the 2017 Water Master Plan – Addendum Riverfront Master Plan 2021. There is no special district agreement between the City and Chehalem Park and Recreation District.

(4) Those state agencies providing funding for or making expenditures on public facility systems shall participate in the development of the public facility plan in accordance with their state agency coordination agreement under ORS 197.180 and 197.712(2)(f).

Finding: No State agency funding sources have been identified at this time for capital expenditures to implement the 2017 Water Master Plan – Addendum Riverfront Master Plan 2021. Future opportunities may be identified.

OAR 660-011-0020

Public Facility Inventory and Determination of Future Facility Projects

(1) The public facility plan shall include an inventory of significant public facility systems. Where the acknowledged comprehensive plan, background document or one or more of the plans or programs listed in OAR 660-011-0010(3) contains such an inventory, that inventory may be incorporated by reference. The inventory shall include:

(a) Mapped location of the facility or service area;

(b) Facility capacity or size; and

(c) General assessment of condition of the facility (e.g., very good, good, fair, poor, very poor).

Finding: The 2017 Water Master Plan – Addendum Riverfront Master Plan 2021, Exhibit “A”, contains an inventory of all significant water facility systems and includes a mapped location, facility capacity and size, and an assessment of the condition of the water system in compliance with OAR 660-011-0020(1)(a-c) and meets the requirement.

(2) The public facility plan shall identify significant public facility projects which are to support the land uses designated in the acknowledged comprehensive plan. The public facility plan shall list the title of the project and describe each public facility project in terms of the type of facility, service area, and facility capacity.

Finding: The 2017 Water Master Plan – Addendum Riverfront Master Plan 2021, Exhibit “A”, identifies water system facility projects that support the projected population and land uses designated in the acknowledged Newberg Comprehensive Plan, and lists by project title and description each project within the plan in compliance with OAR 660-011-0020(2) and meets the requirement.

(3) Project descriptions within the facility plan may require modifications based on subsequent environmental impact studies, design studies, facility master plans, capital improvement programs, or site availability. The public facility plan should anticipate these changes as specified in OAR 660-011-0045.

Finding: The 2017 Water Master Plan – Addendum Riverfront Master Plan 2021, Exhibit “A”, identifies capital improvement projects over the next 20 years. As these projects are further developed through the City’s 5-Year Water Capital Improvement Program (Exhibit “B”, Attachment 2) and as project designs start, the environmental impacts, facility master plans and capital improvement program adjustments may be necessary and will be addressed at that time and any necessary project description modifications in the 2017 Water Master Plan – Addendum Riverfront Master Plan 2021 will be addressed, which meets the requirement.

OAR 660-011-0025

Timing of Required Public Facilities

(1) The public facilities plan shall include a general estimate of the timing for the planned public facility projects. This timing component of the public facilities plan can be met in several ways depending on whether the project is anticipated in the short term or long term. The timing of projects may be related directly to population growth, e.g., the expansion or new construction of water treatment facilities. Other facility projects can be related to a measure of the facility's service level being met or exceeded, e.g., a major arterial or intersection reaching a maximum vehicle-per-day standard. Development of other projects may be more long term and tied neither to specific population levels nor measures of service levels, e.g., sewer projects to correct infiltration and inflow problems. These projects can take place over a long period of time and may be tied to the availability of long-term funding. The timing of projects may also be tied to specific years.

Finding: The 2017 Water Master Plan – Addendum Riverfront Master Plan 2021, Exhibit “A”, includes a general estimate of the timing of the planned public improvements based on population and urban development activities within the Newberg Urban Growth Boundary. The timing is broken down into time horizons of Priority 1 projects (1-5 years) and long term projects 6-20 year horizon which meets the requirement of OAR 660-011-0025(1).

(2) Given the different methods used to estimate the timing of public facilities, the public facility plan shall identify projects as occurring in either the short term or long term, based on those factors which are related to project development. For those projects designated for development in the short term, the public facility plan shall identify an approximate year for development. For those projects designated for development over the long term, the public facility plan shall provide a general estimate as to when the need for project development would exist, e.g., population level, service level standards, etc. Timing provisions for public facility projects shall be consistent with the acknowledged comprehensive plan's projected growth estimates. The public facility plan shall consider the relationships between facilities in

providing for development.

Finding: The 2017 Water Master Plan – Addendum Riverfront Master Plan 2021, Exhibit “A”, identifies short-term and longer term projects identified as horizons of Priority 1 projects in the 1-5 years with the balance identified in the 6-20 year horizon. The Plan Figure 7-1 and Appendix E identify the estimated year within the 1-5 year horizon, but also notes the individual schedule for each project will be refined during pre-design phase for each proposed improvement. The City is utilizing its 5-Year Capital Improvement Program to identify the timing of the short term projects. A copy of the most recent 5-Year Capital Improvement Program is included as Exhibit “B”, Attachment 2. Long term projects are correlated to population growth estimates provided by Portland State University, 2017, which must be used for planning purposes. The requirement to comply with OAR 660-011-0025(2) has been met.

(3) Anticipated timing provisions for public facilities are not considered land use decisions as specified in ORS 197.712(2)(e), and, therefore, cannot be the basis of appeal under ORS 197.610(1) and (2) or 197.835(4).

Finding: The 2017 Water Master Plan – Addendum Riverfront Master Plan 2021, Exhibit “A”, identifies Priority 1 – 4 projects with Priority 1 in the first five year horizon.

OAR 660-011-0030

Location of Public Facility Projects

(1) The public facility plan shall identify the general location of the public facility project in specificity appropriate for the facility. Locations of projects anticipated to be carried out in the short term can be specified more precisely than the locations of projects anticipated for development in the long term.

Finding: The 2017 Water Master Plan – Addendum Riverfront Master Plan 2021, Exhibit “A”, Section 7 and Appendix E identifies the general location of short term and long term projects in compliance with OAR 660-011-0030(1) and meets the requirement.

(2) Anticipated locations for public facilities may require modifications based on subsequent environmental impact studies, design studies, facility master plans, capital improvement programs, or land availability. The public facility plan should anticipate those changes as specified in OAR 660-011-0045.

Finding: The 207 Water Master Plan – Addendum Riverfront Master Plan 2021, Exhibit “A”, identifies capital improvement projects over the next 20 years. As these projects are further developed through the City’s 5-Year Capital Improvement Plan and project designs start then environmental impacts, facility master plans and capital improvement program adjustments may be necessary and will be addressed at that time and any necessary project description modifications in the 2017 Water Master Plan will be addressed, which meets the requirement.

OAR 660-011-0035

Determination of Rough Cost Estimates for Public Facility Projects and Local Review of Funding Mechanisms for Public Facility Systems

(1) The public facility plan shall include rough cost estimates for those sewer, water, and transportation public facility projects identified in the facility plan. The intent of these rough cost estimates is to:

(a) Provide an estimate of the fiscal requirements to support the land use designations in the acknowledged comprehensive plan; and

(b) For use by the facility provider in reviewing the provider's existing funding mechanisms (e.g., general funds, general obligation and revenue bonds, local improvement district, system development charges, etc.) and possible alternative funding mechanisms. In addition to including rough cost estimates for each project, the facility plan shall include a discussion of the provider's existing funding mechanisms and the ability of these and possible new mechanisms to fund the development of each public facility project or system. These funding mechanisms may also be described in terms of general guidelines or local policies.

Finding: The 2017 Water Master Plan – Addendum Riverfront Master Plan 2021, Exhibit “A”, contains cost estimates for the water system. The Newberg City Council accepted the 2020-2025 Water Capital Improvement Program and the funding sources for the wastewater improvements. This overall process meets the requirement of OAR 660-011-0035(1)(a). The 2017 Water Master Plan – Addendum Riverfront Master Plan 2021, Exhibit “A”, identifies the funding methodology for water system improvements in compliance with OAR 660-011-0035(1)(b). The City is also evaluating an urban renewal program for possible water system funding. An Urban Renewal Feasibility Study was accepted on July 20, 2020 by Resolution 2020-3685 and an urban renewal agency was established on August 17, 2020 by Ordinance No. 2020-2865. The urban renewal plan and report is now under development. This overall process meets the requirement of OAR 660-011-0035(1)(a). The 2017 Water Master Plan – Addendum Riverfront Master Plan 2021, Exhibit “A”, identifies the funding methodology for water system improvements in compliance with OAR 660-011-0035(1)(b).

(2) Anticipated financing provisions are not considered land use decisions as specified in ORS 197.712(2)(e) and, therefore, cannot be the basis of appeal under ORS 197.610(1) and (2) or 197.835(4).

Finding: The 2017 Water Master Plan – Addendum Riverfront Master Plan 2021, Exhibit “A”, has financing provisions included in Appendix D for System Development Charges and City funded responsibilities to implement the Water Master Plan and meets the requirement. System Development Charge adjustments for the Riverfront area are pending per the urban renewal plan and report development and will be addressed pending the outcome of formation of the urban renewal program.

OAR 660-011-0040

Date of Submittal of Public Facility Plans

The public facility plan shall be completed, adopted, and submitted by the time of the responsible jurisdiction's periodic review. The public facility plan shall be reviewed under OAR Chapter 660, Division 25, "Periodic Review" with the jurisdiction's comprehensive plan and land use regulations. Portions of public facility plans adopted as part of comprehensive plans prior to the responsible jurisdiction's periodic review will be reviewed pursuant to OAR Chapter 660, Division 18, "Post Acknowledgment Procedures".

Finding: The 2017 Water Master Plan – Addendum Riverfront Master Plan 2021 will be reviewed under OAR Chapter 660, Division 18, "Post Acknowledgment Procedures" as the City of Newberg is not currently in a Periodic Review process under OAR Chapter 660, Division 25 and meets the requirement.

OAR 660-011-0045

Adoption and Amendment Procedures for Public Facility Plans

(1) The governing body of the city or county responsible for development of the public facility plan shall adopt the plan as a supporting document to the jurisdiction's comprehensive plan and shall also adopt as part of the comprehensive plan:

(a) The list of public facility project titles, excluding (if the jurisdiction so chooses) the descriptions or specifications of those projects;

(b) A map or written description of the public facility projects' locations or service areas as specified in sections (2) and (3) of this rule; and

(c) The policy(ies) or urban growth management agreement designating the provider of each public facility system. If there is more than one provider with the authority to provide the system within the area covered by the public facility plan, then the provider of each project shall be designated.

Finding: The 2017 Water Master Plan – Addendum Riverfront Master Plan 2021, Exhibit “A”, is being adopted as a supporting document to the acknowledged Newberg Comprehensive Plan and is being adopted as part of the Newberg Comprehensive Plan as noted in Exhibit “C” and complies with OAR 660-011-0045(1). The 2017 Water Master Plan – Addendum Riverfront Master Plan 2021 includes a listing of projects as identified in Exhibit “A” and meets the requirement of OAR 660-011-0045(1)(a). A map of the location of wastewater system improvements is included in Exhibit “A” and meets the requirement of OAR 660-011-0045(1)(b). The Newberg Urban Area Growth Management Agreement (Exhibit “B”, Attachment 1) identifies that the City of Newberg is the service provider of the water system within the Urban Growth Boundary and the Newberg city limits and meets the requirement of OAR 660-011-0045(1)(c).

(2) Certain public facility project descriptions, location or service area designations will necessarily change as a result of subsequent design studies, capital improvement programs, environmental impact studies, and changes in potential sources of funding. It is not the intent of this division to:

(a) Either prohibit projects not included in the public facility plans for which unanticipated funding has been obtained;

(b) Preclude project specification and location decisions made according to the National Environmental Policy Act; or

(c) Subject administrative and technical changes to the facility plan to ORS 197.610(1) and (2) or 197.835(4).

Finding: The 2017 Water Master Plan – Addendum Riverfront Master Plan 2021, Exhibit “A”, has a list of capital projects to be implemented over the 20 year period. As new funding options may be identified

in the future or environmental reviews requiring modifications to a proposed project, the plan may have to be revisited on an as needed basis in conformance with OAR 660-011-0045(2)(a-c).

(3) The public facility plan may allow for the following modifications to projects without amendment to the public facility plan:

(a) Administrative changes are those modifications to a public facility project which are minor in nature and do not significantly impact the project's general description, location, sizing, capacity, or other general characteristic of the project;

(b) Technical and environmental changes are those modifications to a public facility project which are made pursuant to "final engineering" on a project or those that result from the findings of an Environmental Assessment or Environmental Impact Statement conducted under regulations implementing the procedural provisions of the National Environmental Policy Act of 1969 (40 CFR Parts 1500-1508) or any federal or State of Oregon agency project development regulations consistent with that Act and its regulations.

(c) Public facility project changes made pursuant to subsection (3)(b) of this rule are subject to the administrative procedures and review and appeal provisions of the regulations controlling the study (40 CFR Parts 1500-1508 or similar regulations) and are not subject to the administrative procedures or review or appeal provisions of ORS Chapter 197, or OAR Chapter 660 Division 18.

Finding: No administrative or technical changes are anticipated at this time for the 2017 Water Master Plan. If these situations arise the City of Newberg will comply with the provisions of OAR 660-011-0045(3)(a-b).

(4) Land use amendments are those modifications or amendments to the list, location or provider of, public facility projects, which significantly impact a public facility project identified in the comprehensive plan and which do not qualify under subsection (3)(a) or (b) of this rule. Amendments made pursuant to this subsection are subject to the administrative procedures and review and appeal provisions accorded "land use decisions" in ORS Chapter 197 and those set forth in OAR Chapter 660 Division 18.

Finding: No land use amendments are anticipated at this time that would trigger OAR 660-011-0045(4). If such amendments occur in the future the City of Newberg will comply with OAR 660-011-0045(4).

D. Newberg Municipal Code

Chapter 15.100 LAND USE PROCESSES AND PROCEDURES

15.100.060 Type IV procedure – Legislative.

A. Type IV Actions Are Legislative. The planning commission shall hold a public hearing and make a recommendation to the city council. The city council shall hold another public hearing and make a final decision.

B. Legislative actions include, but are not limited to:

1. Amendments to the Newberg comprehensive plan text;
2. Amendments to the Newberg development code;
3. The creation of any land use regulation.

C. The public hearing before the planning commission shall be held in accordance with the requirements of this code. Notice of a hearing on a legislative decision need not include a mailing to property owners or posting of property (refer to NMC 15.100.200 et seq.).

D. Interested persons may present evidence and testimony relevant to the proposal. If criteria are involved, the planning commission shall make findings for each of the applicable criteria.

E. The city council shall conduct a new hearing pursuant to this code. At the public hearing, the staff shall present the report of the planning commission and may provide other pertinent information. Interested persons shall be given the opportunity to present new testimony and information relevant to the proposal that was not heard before the planning commission.

F. To the extent that a finding of fact is required, the city council shall make a finding for each of the applicable criteria and in doing so may sustain or reverse a finding of the planning commission. In granting an approval, the city council may delete, add, or modify any of the provisions in the proposal or attach certain conditions beyond those warranted for the compliance with standards if the city council determines that the conditions are necessary to fulfill the approval criteria.

G. The city council's decision shall become final upon the effective date of the ordinance or resolution.

Finding: Public hearings with the Planning Commission and the City Council will be required to finalize a decision regarding the application for the amendments to the Comprehensive Plan and Development Code.

This requirement can be met.

Conclusion: The proposed Comprehensive amendment meets the applicable requirements of the Statewide Planning Goals, and the Newberg Comprehensive Plan, and should be approved.

EXHIBIT "B" - ATTACHMENT 1

Ordinance 2021-2876

Newberg Urban Area Growth Management Agreement

Adopted by Newberg City Council on July 2, 1979 and Yamhill County Board of Commissioners on June 20, 1979; As Amended by Newberg City Council on November 2, 1998 and Yamhill County Board of Commissioners on December 3, 1998; As Further Amended by Newberg City Council on June 5, 2000 and Yamhill County Board of Commissioners on December 14, 2000.

Preface

Seen from above, the modern city edges imperceptibly out of its setting. There are no clear boundaries. Just now the white trace of the super highway passed through cultivated fields; now it is an asphalt image of streets and buildings. As one drives in from the airport or looks out from the train window, clumps of suburban houses, industrial complexes, and occasional green space flash by; it is hard to tell where city begins or county ends." (Oscar Handlin, "The Modern City as a Field of Historical Study" in The Historian and the City (Cambridge, Mass. 1963, p.1).

I. Introduction

The City of Newberg and Yamhill County recognize the need for coordination and cooperation in the management of growth in and around the Newberg Urban Area. This agreement is formulated in accordance with this principle.

This agreement establishes a process for maintaining ongoing planning efforts, designed to keep pace with growth and change. It is essential that intergovernmental coordination be maintained to assure the citizens of the City of Newberg and Yamhill County that growth occurs in an orderly and efficient manner.

To that end, this agreement sets forth the means by which a plan for management of the unincorporated area within the Urban Growth Boundary will be implemented and by which the Urban Growth Boundary may be modified.

II. Definitions

Area of Influence - An area of land designated by the City of Newberg and Yamhill County that extends one mile outside Newberg's Urban Growth Boundary wherein the County will give the City an opportunity to participate in land use actions to be taken by the County.

Urban Growth Boundary - A line jointly adopted by the City of Newberg and Yamhill County that encircles the City and separates rural and urbanizable land. Newberg's Urban Growth Boundary is shown on the attached map.

III. General

1. Plan Map Conflicts. The 1979 Comprehensive plan Land Use Map adopted by the City of Newberg on July 2, 1979 shall be the plan map for the area within the Urban Growth Boundary, and shall replace conflicting portions of the Yamhill County Comprehensive Plan Map (1974) pertinent to this area. Where said maps conflict, Yamhill County shall initiate the process necessary for consideration of a map amendment.
2. Urban Growth Boundary. In accordance with the comprehensive Plan of the City of Newberg, the jointly adopted Urban Growth Boundary shall define the geographical limits of urbanization. The City of Newberg shall prepare for the orderly extension of public facilities and services within the boundary. -Lands outside the boundary shall be maintained in accordance with the Yamhill County Comprehensive
3. Urbanization. The City of Newberg and Yamhill County shall encourage urbanization within the boundary to occur in an orderly and efficient manner, resulting in a compact, balanced urban center meeting long-term economic and social needs of the residents of the area regardless of political boundaries.
4. Implementation and Coordination. The very nature of planning requires continual refinement of various elements of the Comprehensive Plan. This includes the preparation of implementing ordinances, refinement plans and functional plans. As the Newberg Comprehensive Plan is implemented, the City and County will work together in a coordinated effort to achieve the goals of the Yamhill County and Newberg Comprehensive Plans.
5. Concurrence and Recommendation. The legitimate interests of the City and County overlap within the City's Urban Growth Boundary and Area of Influence. This agreement attempts to resolve these overlapping interests by providing for concurrence of City and County governing bodies for certain decisions and by providing for recommendations of one governing body to the other for other decisions.
 - a. Concurrence. Where concurrence is required, the City and County shall agree upon a decision. If agreement cannot be reached, procedures outlined in ORS 197.300 may be invoked.
 - b. Recommendation. Where a recommendation is required, the City and County need not agree upon a decision. The procedures are these: The right to object to any item referred to a jurisdiction for a recommendation shall be deemed to have been waived unless the referring jurisdiction is notified otherwise within thirty days; the time limit for consideration of items referred for recommendation shall begin to run from the time the item is received by the jurisdiction whose recommendation is being solicited; each jurisdiction shall have standing to appeal the decision of the other governing body.

IV. Term of this Agreement; Amendment

1. The term of this agreement runs from July 2, 1979, to July 2, 1980, and may be extended thereafter by increments of one year. During the term of the agreement or extension, the agreement may be changed by mutual consent of the parties hereto. This agreement is automatically renewed at the end of such term or extension unless either party hereto requests revision of the agreement by so notifying the other party at least ninety days before the end of the current term or extension.

V. Urban Services

1. The City of Newberg is recognized as the ultimate provider of urban services within the Urban Growth Boundary. To this end:
 - a. Special Districts. Before Yamhill County shall create any special district for the provision of utilities, transportation, or other public facilities or services, the matter shall be referred to the City of Newberg for a recommendation. The County shall not act contrary to such recommendation.
 - b. Service Capacity. Development within the Urban Growth Boundary shall not exceed the capacity of existing services.
 - c. Annexation. Annexation shall occur in accordance with the Newberg Comprehensive Plan. Before final action by the City Council on an annexation proposal, the proposal shall be forwarded to the Board of County Commissioners for its recommendation. In order to provide the board with advance notice of reasoning for a proposed annexation, the findings adopted by the City Planning Commission shall be referred to the board following the Commission action.
 - d. Service Expansion Plans. As the ultimate provider of urban services, the City shall prepare and from time to time update utility expansion plans. These plans shall provide a basis for the extension of services within the Urban Growth Boundary and as such shall be referred to Yamhill County for information and comment.
 - e. Roads. The County and City shall cooperatively develop an implementation policy regarding streets and roads within the Urban Growth Boundary which is consistent with the City Comprehensive Plan. Such policy shall include, but not be limited to, the following:
 - (1) The circumstances under which the City will assume ownership of and maintenance responsibility for County roads within the corporate limits.
 - (2) The conditions under which new public streets and roads will be developed within the urban Growth Boundary.

- (3) The conditions under which existing roads designated as future arterial in the City Comprehensive Plan will be improved.
 - (4) The conditions under which County and other roads should meet City standards within the Urban Growth Boundary. Roads should be compatible with City street alignments and extensions. Upon annexation of property, roads adjacent to (and which serve) such property should also be annexed.
- f. The County and the City through its departments shall coordinate their planning efforts and actions that affect land use with those of special districts.

VI. Establishment of the Newberg Urban Area Management Commission

The City of Newberg and Yamhill County do hereby establish the Newberg Urban Area Management Commission (NUAMC) as a hearings officer in accordance with ORS 215.406. The NUAMC shall be composed of the following members:

- Commissioner of the Yamhill County Board of Commissioners designated by the board.
- Mayor or council person of the City of Newberg designated by the Council.
- Member of Newberg Planning Commission designated by the City Council.
- Member of the Yamhill County Planning Commission Designated by the Board of County Commissioners.
- Member of the Newberg-Dundee P.A.C. designated by the Board of County Commissioners.
- Member of the Newberg Citizen Involvement Advisory Committee designated by the City Council.
- Member-at-large chosen by the above NUAMC members and ratified by the City Council and County Board.

Duties and Responsibilities. The NUAMC shall function in accordance with by-laws to be adopted by the Newberg City Council and the Yamhill County Board of Commissioners.

It shall be the responsibility of the Newberg Urban Area Management Commission to hold hearings, make findings, and present its decision to City and County governing bodies as outlined in this agreement and the by-laws.

VII. Establishment of Land Use Review Procedures

1. Urban Growth Boundary Amendment

Amendment of the Urban Growth Boundary may be initiated by the Yamhill County Board of Commissioners, the Newberg City Council, or by an individual owner(s) of property who request(s) inclusion in or exclusion from the Urban Growth Boundary.

Amendment of the Urban Growth Boundary shall be treated as a map amendment to both the City and County Comprehensive Plan maps.

The joint fee for individual amendment shall be the sum of fees established from time to time by each governing body.

Each application shall include a map and sufficient information to make a decision based on the following factors:

- a. Demonstrated need to accommodate long-range urban population growth requirements consistent with LCDC goals;
- b. Need for housing, employment opportunities, and livability;
- c. Orderly and economic provision for public facilities and services;
- d. Maximum efficiency of land uses within and on the fringe of the existing urban area;
- e. Environmental, energy, economic and social consequences;
- f. Retention of agricultural land as defined, with Class I being the highest priority for retention and Class VI the lowest priority; and,
- g. Compatibility of the proposed urban uses with nearby agricultural activities.

Applications shall be filed with the Newberg Planning Department which shall collect the joint fee and forward the Yamhill County fee along with notice to the Yamhill County Department of Planning and Development. Applications must be complete prior to consideration by the Newberg Urban Area Management Commission.

Applications shall be accumulated and referred quarterly to the Newberg Urban Area Management Commission for a Public Hearing for which at least ten days advance public notice shall be given by publication in a newspaper of general circulation in the County (or published in the territory so concerned--ORS 215.060).

Following the Public Hearing, the NUAMC shall make and forward its findings and decision directly to the governing body of each jurisdiction which shall then make a determination based

upon the facts and record presented at the NUAMC hearing and shall not be required to hold a public hearing thereon.

Nothing included in this process requires or prohibits the City or County from referring the application to its respective Planning Commissions for information.

If the governing bodies do not concur in their final decision within sixty days of referral of the matter to them by the NUAMC, a joint meeting shall be held to resolve differences. If agreement cannot be reached, procedures for resolutions of conflict provided within ORS 197.300 may be invoked.

2. Comprehensive Plan Amendment

- a. Inside U.G.B., but outside city limits. This amendment shall be filed with Yamhill County, and shall otherwise be treated as an amendment to the Urban Growth Boundary.
- b. Inside city limits. The application shall be processed by the City of Newberg and shall be referred to Yamhill County for a recommendation.
- c. Outside the Urban Growth Boundary, but within the "Area of Influence". This amendment shall be processed by Yamhill County and shall be referred to the City of Newberg for a recommendation.

3. Zone Changes

The City of Newberg and Yamhill County recognize that each jurisdiction has authority to zone within its legal boundaries. However, the Urban Growth Boundary recognizes the eventual assumption of authority by the City of Newberg. Therefore, the following procedures are established:

- a. Zone change outside city limits but within the Urban Growth Boundary. Prior to filing an application with Yamhill County, the applicant shall apply for and receive a recommendation from the City of Newberg concerning the requested land use action. Requests shall be processed following the procedures outlined in the Addendum to this agreement, Section 2, item 5 (b). No fee shall be charged for processing a recommendation from the City of Newberg. Applications submitted without this recommendation will be deemed incomplete. The application then shall be processed in accordance with Yamhill County ordinances, except that the application will be referred to the NUAMC for a hearing in lieu of the Yamhill County Planning Commission. Appeals of the NUAMC decision shall be heard by the Yamhill County Board of Commissioners.
- b. Inside city limits. The application shall be processed by the City of Newberg and shall be referred to Yamhill County for information and/or comment.

- c. Outside the Urban Growth Boundary but within the "Area of Influence". The application shall be processed by Yamhill County and shall be referred to the City of Newberg for information and/or comment.

4. Other Items Affecting Land Use

- a. Items having a substantial impact upon land use under the jurisdiction of Yamhill County within Newberg's Area of Influence shall be referred to the City of Newberg for information and comment. Items having a substantial impact upon land use under the jurisdiction of Yamhill County within Newberg's U.G.B. shall be reviewed by the City of Newberg. Prior to filing an application with Yamhill County, the applicant shall apply for and receive a recommendation from the City of Newberg concerning the requested land use action. Requests shall be processed following the procedures outlined in the Addendum to this agreement, Section 2, item 5 (b). No fee shall be charged for processing a recommendation from the City of Newberg. Applications submitted without this recommendation will be deemed incomplete. Items not having a substantial impact may be so referred. Items having a substantial impact upon land use shall include but are not limited to:

- (1) Conditional Use Permits, (Excluding Temporary Hardship Dwellings)
- (2) Planned Unit Developments
- (3) Subdivisions and Partitions
- (4) Public Improvement Projects
- (5) Health Hazards
- (6) Special Exceptions
- (7) Capital Improvement Programs
- (8) Major Transportation Improvements

- b. Within the U.G.B., when Yamhill County ordinances require a Planning Commission public hearing on any of the above items, either as a recommendation or as a final action, the application shall be referred to NUAMC who shall hear the matter in lieu of the Yamhill County Planning Commission. Appeals of the NUAMC decision shall be heard by the Yamhill County Board of Commissioners.

- c. Items having substantial impact upon land use under the jurisdiction of the City of Newberg shall be referred to Yamhill County for information and/or comment. Items not having a substantial impact may be so referred. Items having a substantial impact upon land use shall include but are not limited to:

- (1) Conditional Use Permits
 - (2) Planned Unit Developments
 - (3) Subdivisions and Partitions
 - (4) Public Improvement Projects
 - (5) Extension of the Public Sewer, Water or Storm Drainage systems
 - (6) Capital Improvement Programs
 - (7) Major Transportation Improvements
5. Any of the above applications which may affect an agency identified in the City of Newberg or Yamhill County agency coordination list shall be referred to said agency for information and/or comment.

ADDENDUM TO NEWBERG URBAN AREA GROWTH MANAGEMENT AGREEMENT

This Addendum to Newberg Urban Area Growth Management Agreement pursuant to Newberg City Ordinance #1967 dated July 2, 1979 (hereinafter “Addendum”) is made by agreement between Yamhill County (“County”) and the City of Newberg (“City”).

RECITALS

- A. The City and the County have previously entered into an intergovernmental agreement known as the Newberg Urban Area Growth Management Agreement (“NUAGMA”) pursuant to Newberg City Ordinance #1967 dated July 2, 1979 and Yamhill County Ordinance 214 dated June 20, 1979, setting forth their respective rights and responsibilities with respect to the Urban Growth Boundary (UGB) and Area of Influence.
- B. The County and the City have previously adopted an Urban Reserve Area for the City of Newberg as required by OAR Chapter 660, Division 21, as shown on their comprehensive plan and zoning maps, plan policies and land use regulations, to guide the management of these areas in accordance with the requirements of OAR Chapter 660 Division 21. Newberg City Ordinance 95-2397, Yamhill County Ordinance 596 (copies attached).
- C. The Urban Reserve Area is intended over time to be incorporated into an urban growth boundary. Because full urban services are not yet available in the area, urban level development is not permitted. Very limited rural development of property can occur in the area, but only when such usage is consistent with and does not impede the future urbanization of property.
- D. The purpose of this Addendum is to clarify planning and zoning intents and add provisions to the existing intergovernmental agreement for the purpose of satisfying the requirements of OAR Chapter 660, Division 21 relating to Urban Reserve Areas.

AGREEMENT

NOW, THEREFORE, the City and County agree as follows:

Section 1 Definitions:

- (1) “Urban Reserve Area” has the same meaning as set forth in OAR 660-021-0010 (1), and means lands outside of an urban growth boundary identified as highest priority for inclusion in the urban growth boundary when additional urbanizable land is needed in accordance with the requirements of Goal 14.

Section 2. Compliance with OAR Chapter 660, Division 21. In accordance with the applicable requirements of Chapter 660, Division 21, City and County agree as follows:

- (1) As required by OAR 660-021-0040(3):

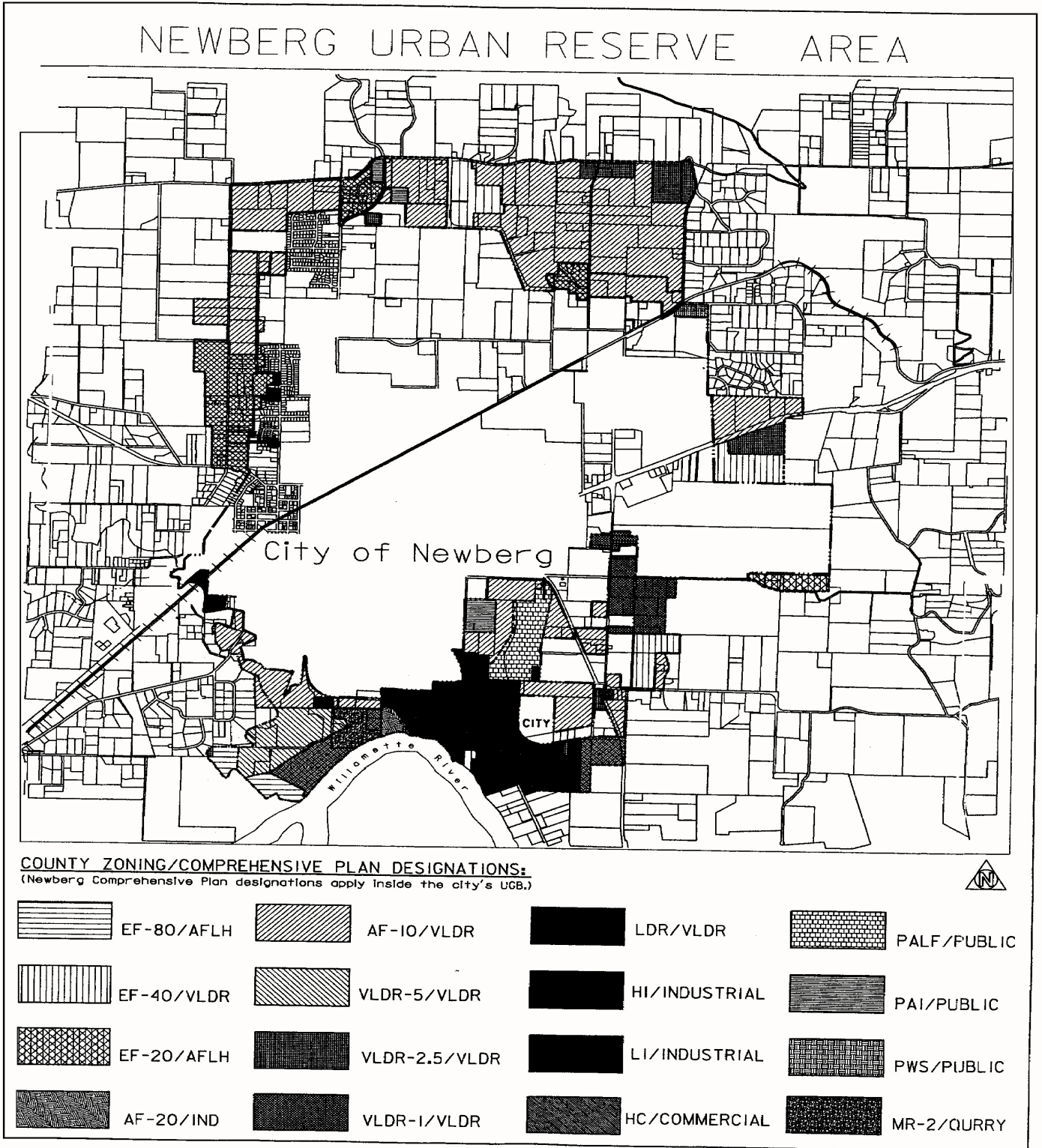
- (a) The County shall prohibit zone amendments allowing more intensive uses, including higher residential density, than permitted at the date of this agreement.
- (2) As required by OAR 660-021-0050(1), unless otherwise agreed to, designation of the local government responsible for building code administration and land use regulation in the URA shall be:
 - (a) Prior to inclusion within the UGB: County
 - (b) After inclusion within the UGB : County
 - (c) After annexation into the city: City
- (3) Designation of service responsibility, as required by OAR 660-021-0050(2):
 - (a) The local government or special district responsible for services (including sewer, water, fire protection, parks, transportation, storm water) for areas within the URA are designated and shown on map(s) attached hereto and incorporated herein as Exhibit "1A."
 - (b) The areas projected for future urban service responsibility after inclusion in the urban growth boundary are shown on map(s) attached hereto and incorporated herein as Exhibit "1A."
- (4) As required by OAR 660-021-0050(3), the terms and conditions under which service responsibility will be transferred or expanded, for areas where the provider of service is expected to change over time, is described in Exhibit "1B," attached hereto and incorporated herein.
- (5) As required by OAR 660-021-0050(4), procedures for notification and review of land use actions to ensure involvement by all affected local governments and special districts:
 - (a) Within the Urban Reserve Area, Comprehensive Plan Amendments, zone changes, and other applications affecting land use, including conditional use, PUDs, subdivisions and partitions, public improvement projects, health hazards, capital improvement programs and major transportation improvements, shall be processed by Yamhill County. Prior to filing an application with Yamhill County, the applicant shall apply for and receive a recommendation from the City of Newberg concerning the requested land use decision. Applications submitted without this recommendation will be deemed incomplete.
 - (b) Upon request or application for a recommendation on a requested land use decision in the URA, the City shall use the following procedures in developing a recommendation (see Exhibit 1C for criteria to be used by the City in the recommendation process):

- (1) Applicant shall file with the City a substantially complete Yamhill County application and include a future development plan as provided in this agreement.
- (2) The City staff or City Council may refer the application to the City Planning Commission for a recommendation to the City Council.
- (3) The recommendation to Yamhill County shall be from the City Council.
- (4) Notice of any hearings shall be to the general public and any hearings shall be legislative in nature. Additional notice may be provided as the City deems necessary. This shall not be a quasi-judicial hearing since the City of Newberg is making a recommendation.
- (5) The City of Newberg shall furnish to the applicant its recommendation to Yamhill County within 60 days of the date that the request for recommendation is filed with the City of Newberg. City staff may request additional information from the applicant concerning the application prior to making a recommendation. Unless otherwise agreed between City and applicant, failure to furnish the recommendation within 60 days will waive the requirement to have a recommendation accompany the application.
- (6) The City reserves the right to make additional recommendations and comments concerning the application to Yamhill County during the Yamhill County process.
- (7) Nothing in this agreement limits the rights of either party in participating in the land use process before either jurisdiction.
- (8) Nothing in this agreement shall be construed as mandatory county approval criteria.

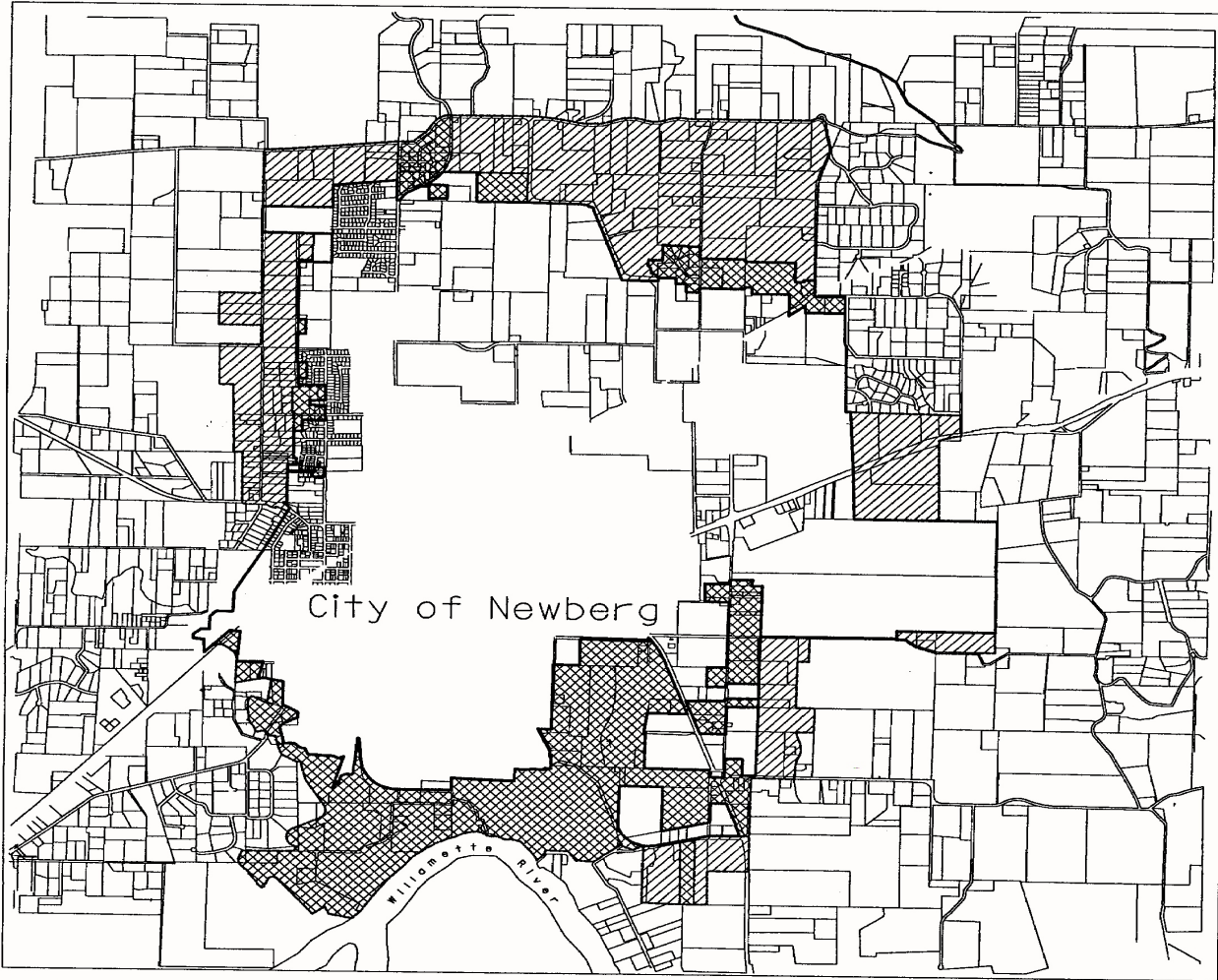
Section 3. In all other respects, the Newberg Urban Area Growth Management Agreement shall remain in full force and effect.

Section 4. Effective Date. This Addendum becomes effective on November 2, 1998.

EXHIBIT 1A URBAN RESERVE AREA MAPS



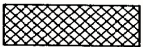
NEWBERG URBAN RESERVE AREA



LEGEND:



Urban Reserve Area



Urban Growth Boundary

————— City Boundary Line

————— Urban Reserve Area

————— Urban Growth Boundary



Special Districts: Yamhill County Extension Service
 Yamhill County Soil and Water Conservation Service
 School District 29J, Newberg
 Yamhill Educational Service District
 Newberg Fire Protection District
 Chehalem Park and Recreation District
 Portland Community College

EXHIBIT 1B
URBAN SERVICE TRANSITION POLICIES

Service Responsibility in General The following “Existing Service Provider” shall be responsible for providing public services within the Urban Reserve Areas. The “Future Urban Service Provider” is the provider projected to have responsibility after inclusion in the UGB or in the City depending on the terms and conditions identified below. The timing for changing the responsible service provider will be flexible, depending on citizen needs and location of properties.

<u>Service</u>	<u>Existing Service Provider</u>	<u>Future Urban Service Provider</u>
Sanitary Disposal	No Public Provider	City of Newberg
Water	Service Districts	City of Newberg
Fire Protection	Newberg Rural Fire District	City of Newberg
Parks & Recreation	Chehalem Park and Recreation District/Yamhill County	Chehalem Park and Recreation District/Yamhill County
Transportation	Yamhill County/ODOT	City of Newberg/ODOT
Storm Water	Yamhill County	City of Newberg

Terms and Conditions under which Service Responsibility will be transferred or expanded.

- D. Special Districts. The City shall agree to the formation of any special district within the Urban Reserve Area prior to the approval of the formation of the district by Yamhill County. This provision shall not apply to County-wide service districts formed under ORS Chapter 451.

- B. Annexation. Annexation of property from the URA may be permitted if contiguous to City limits and shall occur in accordance with the Newberg Comprehensive Plan. Before final action by the City Council on an annexation proposal, the proposal shall be forwarded to the Board of County Commissioners for a recommendation. In order to provide the Board with advance notice of a proposed annexation, the findings adopted by the City Planning Commission shall be referred to the Board following the Planning Commission action.

- C. Service Expansion Plans. Service expansion plans shall be consistent with the Newberg Urban Area Growth Management Agreement. As the future provider of sanitary disposal, storm water and water services, the City shall prepare and from time to time update utility expansion plans. These plans shall provide a basis for the extension of services within the Urban Growth Boundary, and as such shall be referred to Yamhill County for information and comment.

- D. Transition Policies Relating to Service Responsibility
 - 1. Sanitary Sewer Service There will be no public provider of these services until City services are available, except in the case of a state mandate due to a health hazard. At the time of annexation, the City will require hook-up to City sanitary sewer services. Nothing in this provision shall limit the ability of individuals to provide services on their own private property within the Urban Reserve Area.

2. Potable Water Service The City of Newberg shall be the sole and only public provider of water in this area, except for existing water districts, unless new districts are expanded or created through mutual agreement by the City and the County. Nothing in this provision shall limit the ability of individuals to provide services on their own private property within the Urban Reserve Area.
3. Fire Protection The Newberg Rural Fire District provides fire protection services to property within the Urban Reserve Area and the Urban Growth Boundary. The City will provide fire protection services to property within the city limits.
4. Parks and Recreation Chehalem Park and Recreation District and Yamhill County provide park and recreation services within the Urban Reserve Area and the Urban Growth Boundary. Chehalem Park and Recreation District and Yamhill County will remain providers of these services within the city limits unless agreed otherwise.
5. Transportation and Street Improvements Yamhill County provides Transportation services on county roads within the Urban Reserve Area. Yamhill County policies for transfer of jurisdiction are outlined in the Yamhill County Transportation System Plan Section 5.1, Policy 1.5, and Section 5.2.2, Goals and Policies 4, 5, 6 (See attachment Exhibit 1. B.). In summary, the policy is to transfer jurisdiction and maintenance responsibilities to the city upon annexation and improvement to City standards.

Roads in the Urban Reserve Area ultimately are to be developed to City standards. Development in the Urban Reserve Area shall provide adequate transportation facilities to serve the development as provided in Yamhill County ordinances.

The Oregon Department of Transportation provides transportation services on state highways within the Urban Reserve area. The department retains jurisdiction and maintenance responsibilities on all state highways after incorporation into the UGB and annexation except in special cases where jurisdiction is transferred to the City or County by a specific agreement.

6. Storm Water Management Yamhill County provides public storm water management services to property where required within the Urban Reserve Area. The City will provide storm water management services to property within the city limits. Transition of public storm water management services will follow transition of road maintenance responsibilities.

ATTACHMENT TO EXHIBIT 1B

County Transportation Plan (Page 73): The Transportation System Plan (TSP) of Yamhill County provides in Section 5.1, Policy 1.5, Section 5.2.2, Goals and Policies 4, 5, and 6 as follows:

Yamhill County TSP Policy 1.5. *The lead agency for transportation project review shall be:*

- a: Yamhill County for facilities outside the UGBs*
- b. The affected city for facilities within the UGBs*
- c. The State of Oregon. Yamhill County and affected cities on projects involving state-owned facilities.*

Yamhill County TSP Policy 4. *It is the policy of Yamhill County to coordinate the County Transportation System Plan with the transportation plans of the ten incorporated cities within Yamhill County. The County will emphasize continuity in the classification of roads and appropriate design standards for roadways which link urban areas with rural areas outside Urban Growth Boundaries. At the time of UGB amendment Yamhill County and the City involved shall agree on classification and design standards of all County Roads within the proposed UGB area prior to finalization of the amendment.*

Yamhill County TSP Policy 5 *County policy will encourage the expeditious transfer of jurisdiction of roadways to incorporated cities in conjunction with annexation. It is the policy of Yamhill County that developers of property who propose annexation and who have frontage on a road that does not meet City road standards shall have the primary responsibility for upgrading the road to City standards. Roads shall be upgraded at the time of annexation, or the developer shall sign an agreement with the City to upgrade the road, at the time of development. Transfer of jurisdiction shall require the approval of both the County and the City, in accordance with provisions in Oregon Revised Statutes 373.270.*

Yamhill County TSP Policy 6. *It is the policy of Yamhill County to require the transfer, or an agreement to transfer with specific time lines and milestones as part of the agreement, jurisdiction of County roadways within urban growth boundaries to their respective cities at the time of annexation.*

EXHIBIT 1C
CRITERIA AND SUBMITTALS FOR CITY RECOMMENDATION
REGARDING DEVELOPMENT IN THE URA

- A. Criteria: Generally, the following criteria will be used by the City of Newberg in developing City recommendations regarding land use development in the Urban Reserve Area. It is the City's intent to recommend that the County only allow development in the Urban Reserve Area that is limited in scope and that is consistent with the future urban development of the property.
1. Future Development Plan: The City Council shall recommend approval, recommend approval with conditions, or recommend against the future development plan in accordance with the following criteria:
 - (a) The current development shall not cause more than 10 percent of the property to be used for site improvements including buildings, parking areas, improved recreation areas, and storage areas, unless the City agrees the development intensity will not prohibit future urban development.
 - (b) The future development plan shall allow for the efficient future urban development of the remainder of the property. It shall allow for construction of future urban streets and utilities, and shall allow for required setbacks to current and future property lines.
 - (c) The plan is consistent with adopted plans and policies for the area, such as street or utility plans and policies in this agreement.
 2. The City may recommend that the application be approved with conditions, which may include, but are not limited to: an agreement to annex, a deferred improvement agreement for future public facilities; construction of necessary street improvements, storm drains, or other public facilities; dedication of right-of-way, easements for utilities; special setbacks from planned right-of-ways.
- B. Submittal Requirements
1. A future development plan shall be required for any development in the Urban Reserve Area requiring a Yamhill County Type B or Type C review, excluding any development that involves a change in use to existing buildings only. The future development plan shall be used solely to evaluate the current proposal's compatibility with potential future urban development. It does not bind or commit the applicants, property owners, review bodies, or governing bodies to approve or carry out the proposed future development.
 2. The future development plan shall show how the property could be fully developed when incorporated into the city. The plan shall be drawn to scale and shall include the following:
 - (a) The location of potential future streets within and surrounding the site.

- (b) The location of potential future sewer, water, and storm drainage facilities within and surrounding the site.
- (c) The location and approximate dimensions of potential future lot lines.
- (d) Setback lines for proposed structures from current and proposed property lines.

CAPITAL IMPROVEMENT PROGRAM



March 15, 2021

FISCAL YEARS 2021-2026



The Capital Improvement Program (CIP) is the implementation plan for identified software, City facilities, transportation, storm drainage, water, and wastewater projects. The CIP may change based on the community's needs, available budget, regulatory impacts, etc.

CAPITAL IMPROVEMENT PROGRAM

Table of Contents

INTRODUCTION	1
---------------------------	---

MULTI-FUNDED PROJECTS	6
------------------------------------	---

Maintenance Facility Project.....	7
-----------------------------------	---

N. College Street Bike Lanes & Sidewalks/Waterline Relocation/Additional Valves.....	8
--------------------------------------------------------------------------------------------	---

E Crestview Drive; 99W to Springbrook Road.....	9
-------------------------------------------------	---

N Elliott Road; 99W to Newberg High School.....	10
-------------------------------------------------	----

N Springbrook Road	11
--------------------------	----

NE Chehalem Drive Water & Wastewater Extension Project.....	12
----------------------------------------------------------------	----

TRANSPORTATION PROJECTS	13
--------------------------------------	----

ADA/Bicycle/Pedestrian Improvements	14
-------------------------------------------	----

Pavement Preservation	15
-----------------------------	----

N. Main Street/E. Illinois Street Intersection Study	16
---------------------------------------------------------------	----

Safe Routes to School.....	17
----------------------------	----

Transportation System Plan	18
----------------------------------	----

E Mountainview Drive Improvements.....	19
----------------------------------------	----

STORMWATER PROJECTS	20
----------------------------------	----

S Blaine Street; E Hancock to E Eleventh Street	21
----------------------------------------------------------	----

800 Block of NE Wynooski Street.....	22
--------------------------------------	----

RR Ditch; N College – N Meridian	23
----------------------------------------	----

Wynooski Storm Lining.....	24
----------------------------	----

E Vermillion Street East of OR219	25
-----------------------------------------	----

OR240/RR Tracks/N Franklin Street.....	26
----------------------------------------	----

Misc. Storm Drain Repairs	27
---------------------------------	----

N Libra Street.....	28
---------------------	----

Master Plan Projects.....	29
---------------------------	----

WASTEWATER PROJECTS	30
----------------------------------	----

Dehydration Unit Burner Rebuild	31
---------------------------------------	----

Sawdust Bays at the Wastewater Treatment Plant	32
---------------------------------------------------------	----

Inflow and Infiltration Projects.....	33
---------------------------------------	----

Existing Oxidation Ditches	34
----------------------------------	----

Roofing Replacement at the Wastewater Treatment Plant.....	35
---------------------------------------------------------------	----

Secondary Clarifier Re-rating Study.....	36
------------------------------------------	----

Compost Sale Pile Cover.....	37
------------------------------	----

Programmable Logic Controller Study and Replacement.....	38
-------------------------------------------------------------	----

Inflow and Infiltration Report.....	39
-------------------------------------	----

Lift Station Short Term Improvements	40
--------------------------------------------	----

WWTP Hydraulic Improvements.....	41
----------------------------------	----

Upper Portion of Hess Creek Trunk Line	42
----------------------------------------------	----

Parallel Line to Lower Portion of Hess Creek Trunk Line	43
------------------------------------------------------------------	----

W Pinehurst Court Wastewater.....	44
-----------------------------------	----

WWTP Solar Farm.....	45
----------------------	----

N Springbrook Trunk Line.....	46
-------------------------------	----

Riverfront Lift Station.....	47
------------------------------	----

WATER PROJECTS	48
-----------------------------	----

Bell West Pump Station	49
------------------------------	----

Decommission Wells #1 and #2	50
------------------------------------	----

Downtown Fire Flow Project.....	51
---------------------------------	----

Fixed Based Radio Read	52
------------------------------	----

Redundant Supply	53
------------------------	----

Vittoria Square Fire Flow	54
---------------------------------	----

Bell East Pump Station	55
------------------------------	----

Fire Flow - Various.....	56
--------------------------	----

North Valley Reservoir Driveway.....	57
--------------------------------------	----

Routine Water Main Replacement	58
--------------------------------------	----

Water Treatment Plant Filter Covers	59
-------------------------------------------	----

NE Zimri Drive Water Line.....	60
--------------------------------	----

American Water Infrastructure Act.....	61
----------------------------------------	----

Water Treatment Plant Seismic Improvements.	62
---------------------------------------------	----

Emergency Connection & Controls.....	63
--------------------------------------	----

Reservoirs Seismic Improvements.....	64
--------------------------------------	----

HB2001 Improvements	65
---------------------------	----

Otis Springs Improvements	66
---------------------------------	----

CAPITAL IMPROVEMENT PROGRAM

INTRODUCTION

The City Council Goals of Customer Service; Diversity, Equity, and Inclusion; Affordable Workforce Housing; Urban Renewal; and Sustainability flow directly and work in conjunction with the Community Vision that was adopted in 2019.

A NEWberg Community Vision: IN 2040, NEWBERG IS A GEM OF THE WILLAMETTE VALLEY – MIRRORING THE SURROUNDING BUCOLIC LANDSCAPES, ITS CULTIVATED RELATIONSHIPS, FLOURISHING CULTURE, THOUGHTFULLY ENHANCED SENSE OF PLACE, STRONG LOCAL ECONOMY, AND COLLABORATIVE LEADERSHIP NOURISH OUR THRIVING COMMUNITY.

- **COMMUNITY ENGAGEMENT** In Newberg, engagement is a part of who we are. We give our time, talents and treasures to strengthen the community. We blend service into our jobs and institutions, help each other, and pride ourselves in donating and shopping locally. Our authentic relationships serve as a strong foundation for a supportive community
- **COMMUNITY LEADERSHIP** Our leaders come from diverse groups, backgrounds, and sectors throughout the community and surrounding region. They foster creative, two-way communications and collaborate to ensure Newberg's long-term success.
- **CULTURAL ASSETS** Newberg residents take pride in all that our community offers. As a cultural hub, there is a range of accessible artistic events and recreational activities as well as many local shops and restaurants you can wander into with friends.
- **ECONOMIC DEVELOPMENT** Newberg's economy thrives by leveraging our geographic amenities and the capabilities of local businesses and organizations. We create family wage jobs through a strong business and workforce development program. We retain and attract businesses to Newberg and have a vibrant downtown.
- **LIVABILITY & DEVELOPMENT** Newberg is a well-planned community where the built environment blends seamlessly into surrounding, natural landscapes. Our small-town character, accessibility and affordability create a sense of belonging where individuals, families, and people of all ages love to live, work, and play.

The capital infrastructure needs within the five year Capital Improvement Program (CIP) are identified through a variety of sources, including master plans, City Council goals, the Community Vision, operational needs, regulatory obligations and funding availability. The City has completed updates of the utility system master plans over the last several years to address the reduced growth and demand shown in previous master plans. Technical updates to these plans are currently underway to address the Riverfront Master Plan. These plans show a variety of projects in all locations.

The City Council committed to providing well maintained streets to our citizens when the Transportation Utility Fee was adopted and implemented in 2017. The goal was to maintain the current condition of the roadway system which is one of the most valuable assets the City owns. In the intervening years the City has improved a significant number of road segments and has maintained the overall condition of the asset. One complicating factor is the need for adequate utilities under the pavement. This provides the challenge of coordinating the roadway needs with the underground utility needs. The need

CAPITAL IMPROVEMENT PROGRAM

for sidewalks and ADA facilities within our public rights-of-way continue. There will be a renewed commitment to address those locations that will provide the greatest benefit (i.e. Critical Routes noted in the 2007 ADA Pedestrian Bike Plan; and School Routes).

The City continues to focus its efforts towards establishing a high quality and adequate potable water supply, storage, and distribution system. The City's utility systems are vulnerable to damage resulting from a Cascadia Subduction Zone earthquake. Because of this, additional requirements have been added by the State to complete a seismic risk assessment and mitigation plan as a part of five year updates to the Water System Master Plans. The seismic risk assessment was completed in 2020 and several of the projects proposed are incorporated into this five year program. Phases 1 & 2 of the Safe, Reliable Water project was also completed in 2020, and Phase 3 of the project is moving forward based on the City Council's direction to provide additional resiliency to the City's potable water system.

As in the past, the focus of the wastewater program is to aggressively repair and/or replace inadequate portions of the wastewater system. Several projects to eliminate and/or reduce the stormwater that infiltrate the wastewater pipes were completed in the last several years and there has been a noticeable reduction (37%) in Inflow and Infiltration in those basins. These projects will continue. The City will continue upgrades to the Wastewater Treatment Plant with roofing repairs, structural repairs to the existing oxidation ditches, remodel of the office building and studies addressing the capacity of the plant.

Capital projects within the City are funding by a variety of mechanisms. They include:

- Enterprise Funds: these funds are revenues from monthly rates (water, wastewater and stormwater) paid by customers. These funds can only be spent on projects in those systems.
- Gas Taxes: these are revenues from both Federal and State gas taxes. These funds can only be spent on roadway projects. At least 1% of the state gas taxes must be spent on bicycle and pedestrian facilities.
- Transportation Utility Funds: these are revenues paid monthly by customers. These funds must be used on existing pavement and ADA requirements.
- System Development Charges: these funds are paid by developers and can only be used on capacity increasing projects.
- Grants: these are funds received from a variety of locations.

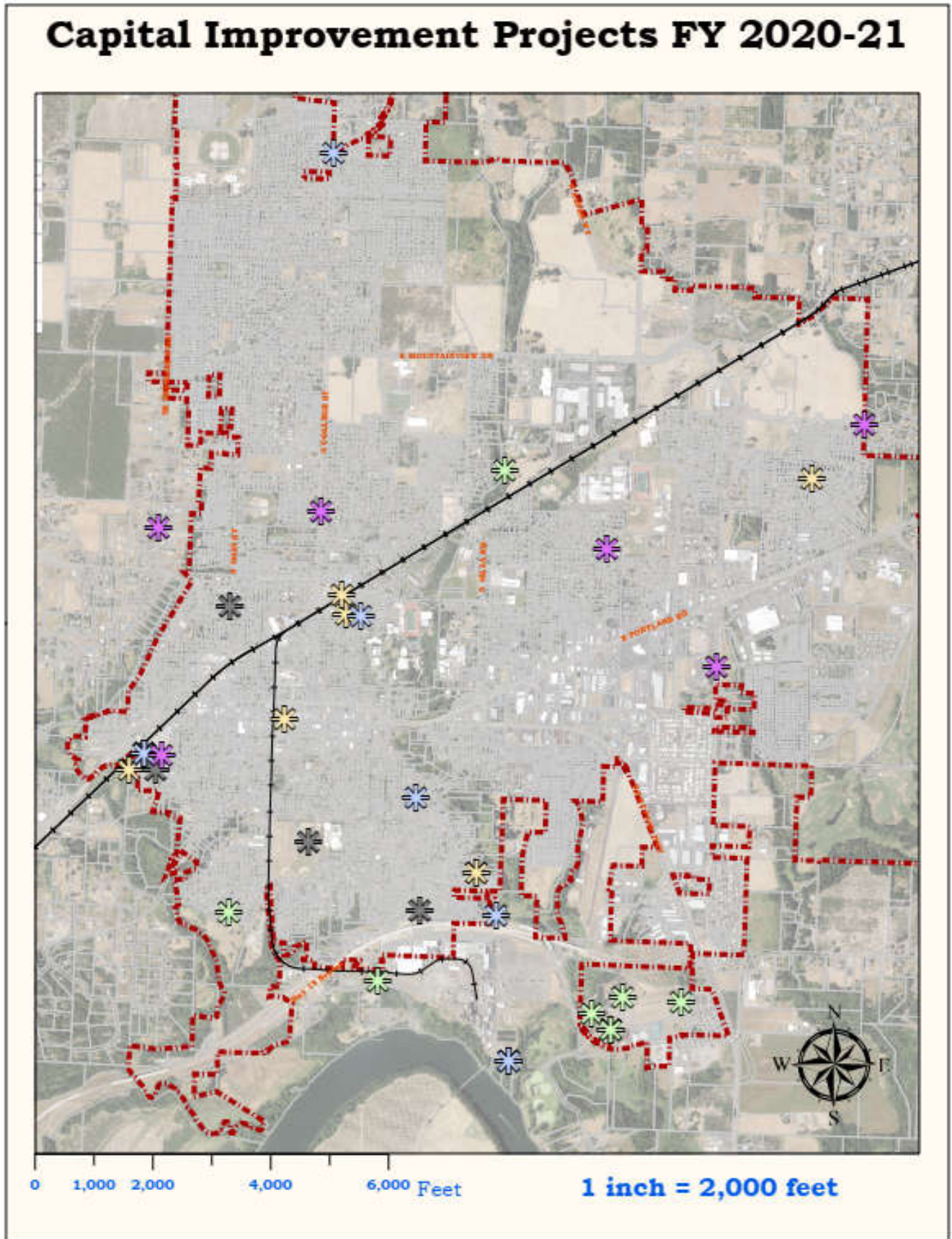
The Public Works Engineering Division works closely with Public Works Operations and Maintenance Divisions to complete the identified projects on an annual basis. The fiscal year 2021-2022 Capital Improvement Program implements the planning, design, and construction of the capital infrastructure needs of the City by prioritizing projects based on an analysis of the master plans and other studies in combination with the availability of funding. The scheduled projects in the years beyond FY 2021-2022 are not intended to be a spending commitment, but are included to show a proposed plan for the projects that are considered to be a priority at this particular snapshot in time.

CAPITAL IMPROVEMENT PROGRAM

	FY20/21	FY21/22	FY22/23	FY23/24	FY24/25	FY25/26
TOTAL WASTEWATER PROJECTS	\$ 3,743,070	\$ 4,178,697	\$ 1,934,127	\$ 3,303,369	\$ 3,024,546	\$ 2,865,726
TOTAL STORMWATER PROJECTS	\$ 122,500	\$ 859,799	\$ 327,818	\$ 752,795	\$ 262,298	\$ 338,810
TOTAL TRANSPORTATION PROJECTS	\$ 605,252	\$ 2,471,570	\$ 1,593,727	\$ 1,644,538	\$ 1,580,648	\$ 2,108,997
TOTAL WATER PROJECTS	\$ 2,275,879	\$ 6,897,642	\$ 4,772,608	\$ 3,356,477	\$ 2,479,571	\$ 5,526,619
TOTAL MULTI FUNDED PROJECTS	\$ 1,580,087	\$ 7,005,792	\$ 286,106	\$ 675,305	\$ 347,782	\$ 273,182
TOTAL CAPITAL PROJECT PROGRAM	\$8,306,788	\$21,456,582	\$8,954,824	\$9,733,604	\$7,695,248	\$11,112,998

A map of the Capital Improvement Projects for FY 2021-2022 is shown on the following page.

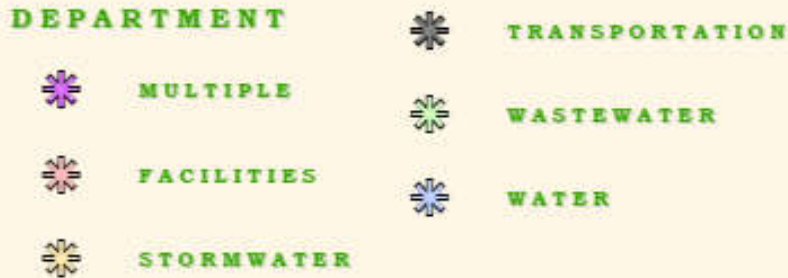
CAPITAL IMPROVEMENT PROGRAM



CAPITAL IMPROVEMENT PROGRAM

FY	DEPT	Projected Cost	Notes (Funding Sources, Etc.)	Project Description
21/22	MULTIPLE	\$2,757,000	GAS TAX, STORMWATER, SDCs	N ELLIOTT RD: 99W TO NEWBERG HS
21/22	MULTIPLE	\$1,915,067	TRANSPORTATION SDCs, STATE, CRESTVIEW MING, OTHER	E CRESTVIEW DR: N SPRINGBROOK TO 99W
21/22	MULTIPLE	\$1,308,000	SDCs	CHEHALEM DRIVE EXTENSION PROJECT
21/22	MULTIPLE	\$820,633	COOT	N COLLEGE ST BIKE LANES AND SIDEWALKS
21/22	MULTIPLE	\$138,500	GAS, STORMWATER, TRANSPORTATION SDCs	N SPRINGBROOK RD
21/22	MULTIPLE	\$68,592	UTILITIES, SDCs	P/W FACILITY MASTER PLAN
21/22	STORMWATER	\$303,164		LIBRA ST IMPROVEMENTS
21/22	STORMWATER	\$215,000		800' BLOCK WYNOOSKI EXTENSION
21/22	STORMWATER	\$135,000		PAVEMENT FIXES
21/22	STORMWATER	\$79,568		WYNOOSKI ST FROM 7TH TO 800 BLOCK LINING
21/22	STORMWATER	\$79,568		VERMILION ST - EAST OF 219
21/22	STORMWATER	\$48,000		RR DITCH - STUDY AND FIX
21/22	STORMWATER	\$2,500		MASTER PLAN
21/22	TRANSPORTATION	\$1,891,350		PAVEMENT MAINTENANCE PROGRAM
21/22	TRANSPORTATION	\$365,222		MAIN ST/ ILLINOIS INTERSECTION STUDY
21/22	TRANSPORTATION	\$165,000		ADA/SIDEWALK IMPROVEMENTS
21/22	TRANSPORTATION	\$150,000		SAFE ROUTES TO SCHOOL
21/22	WASTEWATER	\$1,525,000		PLC Study and Replacement
21/22	WASTEWATER	\$800,000		ORINATION DITCH
21/22	WASTEWATER	\$530,480		WWTP HYDRAULICS
21/22	WASTEWATER	\$500,000		HESS CREEK LINING
21/22	WASTEWATER	\$400,000		INFLOW & INFILTRATION PROJECTS
21/22	WASTEWATER	\$252,941		SOLAR FARM
21/22	WASTEWATER	\$212,180		RIVERFRONT PUMP STATION
21/22	WASTEWATER	\$88,167		WWTP SAWDUST BAYS
21/22	WASTEWATER	\$68,968		DEHYDRATION UNIT
21/22	WASTEWATER	\$1,000		OPERATIONS REMODEL
21/22	WATER	\$1,859,871		REDUNDANT WATER SUPPLY
21/22	WATER	\$1,220,000		BELL WEST PUMP STATION
21/22	WATER	\$900,407		WTP FILTER COVERS
21/22	WATER	\$562,754		EMERGENCY CONNECTIONS & CONTROLS AT WTP
21/22	WATER	\$365,790		FIXED BASE RADIO READ
21/22	WATER	\$281,377		HB 2001 WATERLINE
21/22	WATER	\$250,000		ROUTINE MAIN REPLACEMENT PROGRAM
21/22	WATER	\$232,000		FIRE FLOW CAPACITY IMPROVEMENTS
21/22	WATER	\$168,825		SEISMIC IMPROVEMENTS - WATERLINE REPLACEMENT
21/22	WATER	\$166,575		HB 2001 WATERLINE - 5TH
21/22	WATER	\$90,000		A/A/A
21/22	WATER	\$22,510		NEW HYDRANTS AND VALVES
21/22	WATER	\$12,381		HB 2001 WATERLINE

Capital Improvement Projects



IMPORTANT NOTICE TO ALL USERS:

DISCLAIMER AND LIMITATION OF LIABILITY

This information is not guaranteed to be accurate and may contain errors and omissions. The City of Newberg provides NO WARRANTY AS TO THE MERCHANTABILITY OR FITNESS FOR A PARTICULAR PURPOSE FOR ANY INFORMATION HEREIN.

This map is created from various data sources and is subject to change without notice. This map is intended for general planning purposes only.

Coordinate System: NAD83 Oregon North

Projection: Lambert Conformal Conic

Datum: North American 1983

false easting: 8,202,099.7375

false northing: 0.0000

central meridian: -120.5000

standard parallel 1: 44.3333

standard parallel 2: 46.0000

latitude of origin: 43.6667

Units: Foot

Document Path: G:\GIS\MapRequest\Paul\Payment Projects\CIP 2021_2022 1x17.mxd

Date Saved: 2/24/2021 11:31:43 AM

Author: Keith McKinnon, GIS Analyst

City Limit



County Tax Lots



CAPITAL IMPROVEMENT PROGRAM

MULTI-FUNDED PROJECTS

The following project summary sheets were developed from a variety of sources. The projects affect all of the enterprise funds and include things like improvements to facilities and major software purchases. This section also includes infrastructure projects that have funding from multiple utilities.

MULTI FUNDED PROJECTS	FY20/21	FY21/22	FY22/23	FY23/24	FY24/25	FY25/26
Public Works Maintenance Facility Master Plan	\$ 120,000	\$ 131,184	\$ 131,184	\$ 25,000	\$ 25,000	\$ 25,000
N College Street Bike Lanes and Sidewalks/Waterline Relocation/Additional Valves	\$ 284,949	\$ 820,633				
N Springbrook Road	\$ 15,000	\$ 139,500	\$ 218,545	\$ 675,305	\$ 347,782	\$ 273,182
NE Chehalem Drive Water & Wastewater Ext	\$ 65,205	\$ 1,308,000				
N Elliott Road: 99W to Newberg High School	\$ 850,000	\$ 2,757,000				
E Crestview Drive: 99W to Springbrook Road	\$ 244,933	\$ 1,915,067				
TOTAL MULTI FUNDED PROJECTS	\$ 1,580,087	\$ 7,071,384	\$ 349,729	\$ 700,305	\$ 372,782	\$ 298,182

CAPITAL IMPROVEMENT PROGRAM

MULTI-FUNDED PROJECT Maintenance Facility Project

CONTACT
maintenance@newbergoregon.gov

A master plan has been completed on what the newly expanded maintenance yard could look like. The rest of the improvements include major site work, fleet building and eventually a new administration building. A fully functional maintenance facility is critical to serve the existing and long term day to day needs of the City and to adequately respond to natural disasters with the needed man power and equipment.

PROPOSED FUNDING

The project is to be funded by utility funds, and system development charges.

MEDIUM PRIORITY PROJECT

The council has identified increased sustainability as priorities for Newberg. The proposed improvements will further this goal. Along with responding to council goals the project will:

- Increase health and safety
- Reduce costs
- Provides for existing and future capacity

HISTORY OF THE PROJECT

In 2015, it was determined that the City had outgrown the existing 2.1 acre maintenance yard and purchased property next to the existing location to expand the yard by 3.9 acres. A facility plan was then conducted to determine the specific needs on this site.

STATE MANDATED FEATURES

NA

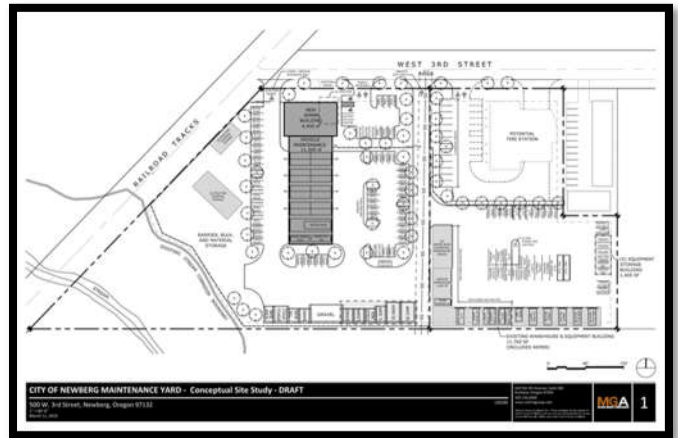


FIGURE 1 CONCEPTUAL PUBLIC WORKS MAINTENANCE YARD PLAN

CAPITAL IMPROVEMENT PROGRAM

MULTI-FUNDED PROJECT

E Crestview Drive;
99W to Springbrook Road

The project will improve E Crestview Drive which connects residents in Northern Newberg with Highway 99W. Road improvements will make the road safer for walking and biking, improve road conditions, and brings the street up to major collector street standards.

PROPOSED FUNDING

- Transportation System Development Charges: \$1,100,000
- State of Oregon: \$740,000
- Remaining balance: funded by Springbrook Properties and JT Smith's Crestview Crossing Planned Unit Development
- Other – the water and wastewater lines will be funded by utility rates and system development charges

HIGH PRIORITY PROJECT

The Council has identified increased sustainability and improved diversity, equity, and inclusion as priorities for Newberg. Improving roads and constructing sidewalks and bike lanes will allow community members better access to services near the hospital and encourages more walking and bike use. Along with responding to Council goals the project will:

- Increase health and safety
- Reduce costs
- Coordinates with larger planned projects
- Has additional funding opportunities available

HISTORY OF THE PROJECT

E Crestview Drive is an important transportation link to the northern portion of the City. The city's 2016 Transportation System Plan (TSP) identified the need to reconstruct E Crestview Drive to major collector street standards between N Springbrook Road and the Newberg city limit line. In December 2015, Regional Solutions awarded the City of Newberg a \$740,000 grant for construction of E Crestview Drive from Highway 99W to N Springbrook Road.

MANDATED FEATURES

The state and federal governments require that bike facilities and ADA facilities be constructed on any roadway that will be constructed, reconstructed or relocated.

- ORS366.514, enacted in 1971, requires that roadways being built, or reconstructed, include both pedestrian and bicycle facilities.
- The ADA law requires newly designed and constructed or altered State and local government facilities, public accommodations, and commercial facilities to be readily accessible to and usable by individuals with disabilities.

CONTACT

brett.musick@newbergoregon.gov



[Visit the Crestview Drive Project webpage](#)

CAPITAL IMPROVEMENT PROGRAM

MULTI-FUNDED PROJECT

NE Chehalem Drive Water & Wastewater Extension Project

This project extends the public wastewater line from the existing terminus on the east side of Chehalem Creek on Hwy 240 to NE Chehalem Drive and then north on NE Chehalem Drive towards the intersection with E Columbia Drive.

This master plan project (M-18) would extend the public water line from the existing terminus on the east side of Chehalem Creek on Hwy 240 to NE Chehalem Drive. The new waterline will connect with an existing waterline on NE Chehalem Drive south of Hwy 240. A future project (M-19) would extend the waterline on NE Chehalem Drive to E Columbia Drive.

PROPOSED FUNDING

This will be paid for out of system development charges.

MEDIUM PRIORITY PROJECT

This project will provide additional capacity for future development. Fire flow deficiencies in the area of W Illinois are also addressed with this project.

HISTORY OF THE PROJECT

There have been several development inquiries in this area and the wastewater and water line extensions would allow for orderly future development. The 2017 Water Master Plan identified that this area has a fire flow and pressure deficiency. The cost and complexity of designing, constructing and permitting utility crossings of the un-named tributary of Chehalem Creek has been identified as prohibitive for private development of the water and wastewater extensions to this portion of the City's Urban Growth Boundary (UGB).

MANDATED FEATURES

NA

CONTACT

brett.musick@newbergoregon.gov

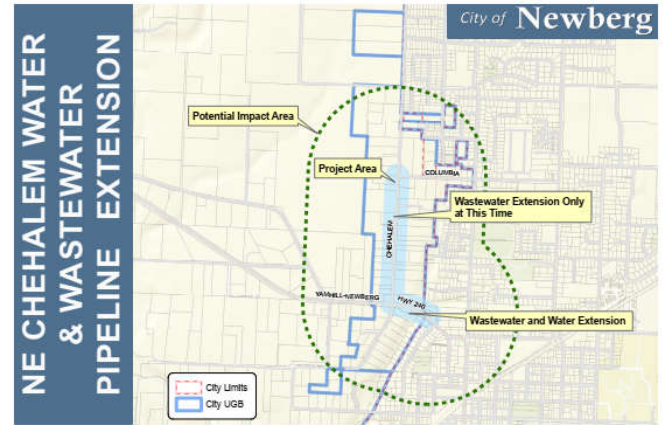


FIGURE 4 EXTENDING THE PUBLIC WASTEWATER LINE

[Visit the NE Chehalem Drive Water and Wastewater Extension Project webpage](#)

CAPITAL IMPROVEMENT PROGRAM

WATER PROJECTS

The Water Program provides planning, design and construction of improvements for the City's public water utility system. This program area includes the well field, storage reservoirs, water treatment plant, pump stations, and water distribution system.

The following project list was developed from the 2017 Water Master Plan and other associated studies while considering the available funds from the water utility rates and system development charges. As we embark on the redundant water supply project and the water system resiliency study additional projects will be added to this list.

WATER PROJECTS	FY20/21	FY21/22	FY22/23	FY23/24	FY24/25	FY25/26
Redundant Water Supply	\$ 228,405	\$ 1,859,871	\$ 1,254,161	\$ 597,026	\$ -	\$ -
Bell East Pump Station - Zone 3 constant pressure		\$ -		\$ -	\$ -	\$ 918,408
Bell West Pump Station - Zone 2 constant pressure	\$ 228,405	\$ 1,220,000	\$ -	\$ -	\$ -	\$ -
Upsize existing mains and construct new distribution loops to improve fire flow capacity	\$ 60,000	\$ 232,000	\$ 639,919	\$ -	\$ -	\$ -
NE Zimri Drive Zone 3 distribution backbone within UGB		\$ -	\$ -	\$ -	\$ 425,536	\$ -
N College Street - N Terrace Street - proposed Bell West P.S. (P-2) - Veritas School	\$ 51,989	\$ 750,000	\$ -	\$ -	\$ -	\$ -
Routine Main Replacement Program	\$ 200,000	\$ 250,000	\$ 200,000	\$ 200,000	\$ 200,000	\$ 200,000
Water System Master Plan update	\$ 53,752	\$ -	\$ -	\$ -	\$ -	\$ -
North non-potable water line and Otis Springs pumping improvements	\$ -	\$ -	\$ -	\$ 522,398	\$ 538,070	\$ -
New hydrants and valves	\$ 20,000	\$ 22,510	\$ 23,185	\$ 23,881	\$ 24,597	\$ 25,335
Fixed Base Radio Read	\$ 552,328	\$ 365,790	\$ 231,855	\$ -	\$ -	\$ -
Decommission Well #1		\$ -	\$ 100,000	\$ -	\$ -	\$ -
Decommission Well #2		\$ -	\$ 100,000	\$ -	\$ -	\$ -
WTP Filter Covers	\$ 200,000	\$ 900,407	\$ -	\$ -	\$ -	\$ -
Nvalley Reservoir Driveway		\$ -	\$ 231,855	\$ -	\$ -	\$ -
WTP Property Purchase	\$ 525,000	\$ -	\$ -	\$ -	\$ -	\$ -
WTP Seismic Improvements	\$ -	\$ -	\$ 1,159,274	\$ 1,194,052	\$ -	\$ 1,266,770
Emergency Connection & Controls at WTP	\$ -	\$ 562,754	\$ -	\$ -	\$ -	\$ -
Seismic Improvements at Water Reservoirs	\$ -	\$ -	\$ -	\$ -	\$ 614,937	\$ 633,385
Seismic Improvements - Waterline Replace	\$ -	\$ 168,826	\$ 173,891	\$ 179,108	\$ 184,481	\$ 190,016
HB 2001 Waterline - Main, 4th, Lincoln & 5th	\$ -	\$ -	\$ 231,855	\$ 341,499	\$ -	\$ -
HB 2001 Waterline - Blaine St	\$ -	\$ -	\$ -	\$ -	\$ -	\$ 1,028,617
HB 2001 Waterline - Meridian	\$ -	\$ -	\$ -	\$ -	\$ -	\$ 557,379
HB 2001 Waterline - 7th, Pacific, 9th & Paradise	\$ -	\$ -	\$ -	\$ 298,513	\$ 491,950	\$ 506,708
HB 2001 Waterline - River	\$ -	\$ 281,377	\$ 426,613	\$ -	\$ -	\$ -
HB 2001 Waterline - 5th	\$ -	\$ 166,575	\$ -	\$ -	\$ -	\$ -
HB 2001 Waterline - 11th & Boston Square	\$ -	\$ 55,150	\$ -	\$ -	\$ -	\$ -
HB 2001 Waterline - Vermillion	\$ -	\$ 12,381	\$ -	\$ -	\$ -	\$ -
AWIA	\$ 156,000	\$ 50,000	\$ -	\$ -	\$ -	\$ 200,000
TOTAL WATER PROJECTS	\$ 2,275,879	\$ 6,897,642	\$ 4,772,608	\$ 3,356,477	\$ 2,479,571	\$ 5,526,619

CAPITAL IMPROVEMENT PROGRAM

WATER PROJECT Bell West Pump Station

The proposed pump station is needed to supply adequate fire flow and constant service pressure to the Zone 2 expansion area. Once the Bell Road Reservoir is constructed, this pump station will be used to supply a future reservoir.

Additionally, this project extends waterlines from N Terrace Drive to the intersection of N College and NE Valley Road and then to the east down NE Bell Road. This will help supply water for future Zone 2 development.

PROPOSED FUNDING

This project will be funded for out of water rate revenues and system development charge funds.

HIGH PRIORITY PROJECT

The Council has identified increased sustainability as a priority for Newberg. Along with responding to Council goals the project will:

- Increase health and safety
- Reduce costs

HISTORY OF THE PROJECT

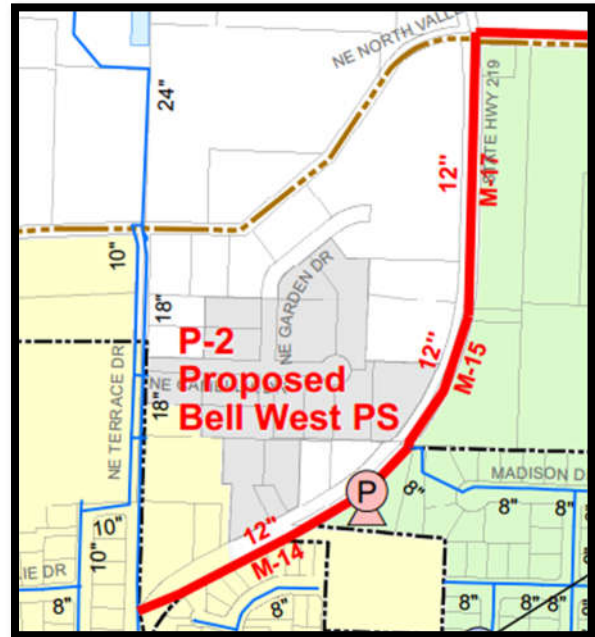
The Oak Knoll Water Booster Pump Station at 3613 N Ivy Drive was installed in 2000 to provide a constant water pressure (Pressure Zone 2) to serve 42 homes along Knoll Drive at the city's northern water service area. Since then, 16 homes along W Madison Drive, and Veritas School, were added and served by the city's potable water system. Any additional connections to this system could impact the operation of the existing Oak Knoll Booster Pump Station.

MANDATED FEATURES

NA

CONTACT

paul.chiu@newbergoregon.gov



CAPITAL IMPROVEMENT PROGRAM

WATER PROJECT

Decommission Wells #1 and #2

This project would properly decommission the wells that are no longer being used per state standards.

PROPOSED FUNDING

This will be paid for out of water rate and system development charge funds.

MEDIUM PRIORITY PROJECT

This is a regulatory requirement that must be completed by the City.

HISTORY OF THE PROJECT

Wells #1 & #2 have reached the end of life and are not being utilized.

MANDATED FEATURES

This is regulated by OAR 690-220-0030.

CONTACT

engineering@newbergoregon.gov

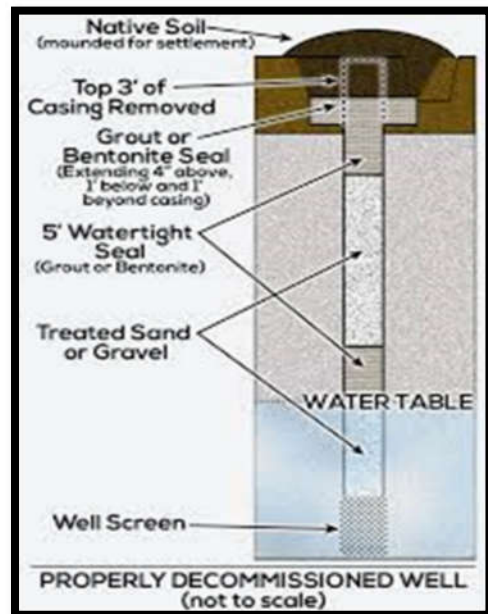


FIGURE 24 DECOMMISSION WELLS 1 & 2

CAPITAL IMPROVEMENT PROGRAM

WATER PROJECT

Downtown Fire Flow Project

This project is to replace several non-looped sections of 1 and 2 inch diameter water mains along Hancock Street through downtown Newberg.

PROPOSED FUNDING

This project will be paid for out of water rate revenues and system development charge funds.

HIGH PRIORITY PROJECT

The Council has identified increased sustainability as a priority for Newberg. Along with responding to Council goals the project will increase health and safety.

HISTORY OF THE PROJECT

Fire flow deficiencies occur in this area and the project will also improve fire hydrant spacing and coverage. This project will coordinate with the adopted 2016 Downtown Improvement Plan.

MANDATED FEATURES

NA

CONTACT

engineering@newbergoregon.gov



FIGURE 25 REPLACING DEFICIENT PIPE AND INADEQUATE FIRE HYDRANTS ON HANCOCK STREET

CAPITAL IMPROVEMENT PROGRAM

WATER PROJECT

Fixed Based Radio Read

Advanced metering infrastructure (AMI) is an integrated system of smart meters, communications networks, and data management systems that enables two-way communication between utilities and customers. The project will consist of the installation of two lattice towers, the RNI/Customer portal and the replacement of meters and meter boxes.

PROPOSED FUNDING

This project will be paid for out of water rate and SDC funds.

HIGH PRIORITY PROJECT

The Council has identified increased sustainability and improved diversity, equity, and inclusion as priorities for Newberg. Along with responding to council goals the project will:

- Increase health and safety
- Reduce costs

HISTORY OF THE PROJECT

The existing meter reading system requires that someone drive through the entire city to read the meters. The fixed based system will allow for the meters to be read from the utility billing office in real time. This will cut down on labor costs and could detect a leak sooner. Rate payers will also have the ability to gain access to hourly real-time and historical water use information. Operations and treatment plant staff will have access to real time data.

MANDATED FEATURES

NA

CONTACT

kaaren.hofmann@newbergoregon.gov

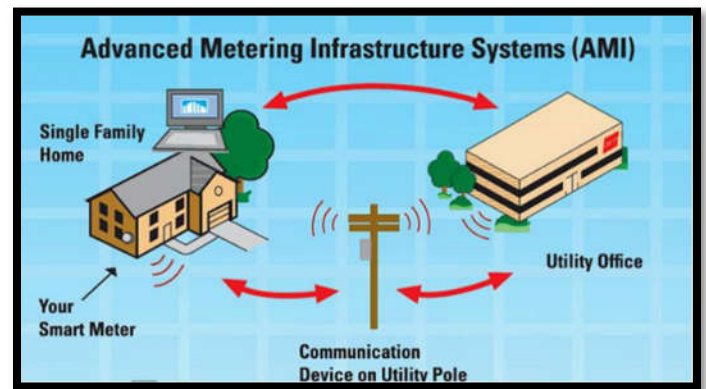
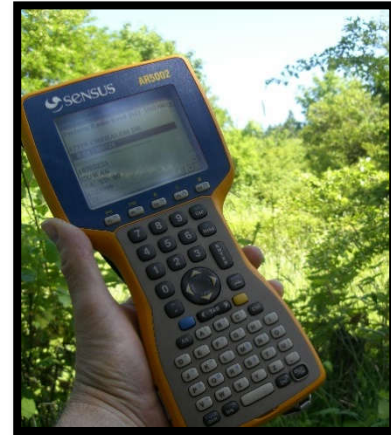


FIGURE 26 READING METERS CURRENTLY (TOP) VS ADVANCED WATER METERING READING INFRASTRUCTURE SYSTEM (BOTTOM)

CAPITAL IMPROVEMENT PROGRAM

WATER PROJECT Redundant Supply

The City's current water supply is the well field on the south side of the Willamette River. To address supply vulnerability and long-term water resiliency, per the 2017 Water System Master Plan, the City should pursue another source north of the Willamette River. This project would include water rights, exploration, property acquisition and potentially the construction of a secondary treatment plant.

Phase 1 & 2 of the project are completed. Phase 3 is underway.

PROPOSED FUNDING

This will be paid for out of water rate revenues and SDC funds.

HIGH PRIORITY PROJECT

Providing for a Safe and Reliable Water System for our citizens is a necessary function of the City. Development of an additional water supply and a seismically resilient system focuses on customer service and sustainability of one of our most valuable resources. Along with responding to Council goals the project will:

- Increase health and safety

HISTORY OF THE PROJECT

The City's 2017 Water Master Plan notes that the City's water supply source is vulnerable to flooding, ground movement, seismic activity or other natural disasters. If something was to occur to that source, the City would be unable to provide water to its residents.

MANDATED FEATURES

NA

CONTACT

kaaren.hofmann@newbergoregon.gov

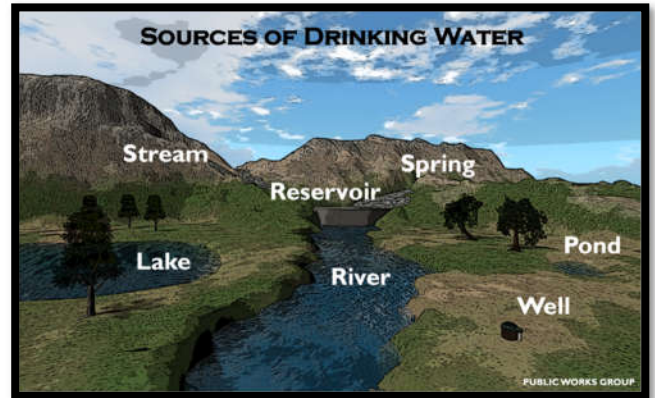


FIGURE 27 EXPLORING FUTURE WATER SUPPLY

CAPITAL IMPROVEMENT PROGRAM

WATER PROJECT Vittoria Square Fire Flow

This project will install of 600 lineal feet of 8" waterlines and will address a fire flow deficiency.

PROPOSED FUNDING

This will be paid for out of water rate revenues and SDC funds.

HIGH PRIORITY PROJECT

The Council has identified increased sustainability as a priority for Newberg. Along with responding to Council goals the project will increase health and safety.

HISTORY OF THE PROJECT

The recent 2017 Water Master Plan update revealed that this area has a fire flow and pressure deficiency under existing conditions and future growth.

MANDATED FEATURES

NA

CONTACT

paul.chiu@newbergoregon.gov



FIGURE 28 EXPANDING WATERLINE TO ELIMINATE DEFICIENT WATER FLOW AND FOR FUTURE GROWTH

CAPITAL IMPROVEMENT PROGRAM

WATER PROJECT Bell East Pump Station

The proposed pump station is needed to supply adequate fire flow and constant service pressure to the Zone 2 expansion area. Once the Bell Road Reservoir is constructed, this pump station will be used to supply the future reservoir.

PROPOSED FUNDING

This project will be funded by SDC funds.

LOW PRIORITY PROJECT

This project is to provide for future growth.

HISTORY OF THE PROJECT

This project is in the 2017 Water Master Plan and is needed as development occurs north of and along NE Zimri Drive.

MANDATED FEATURES

NA

CONTACT

engineering@newbergoregon.gov

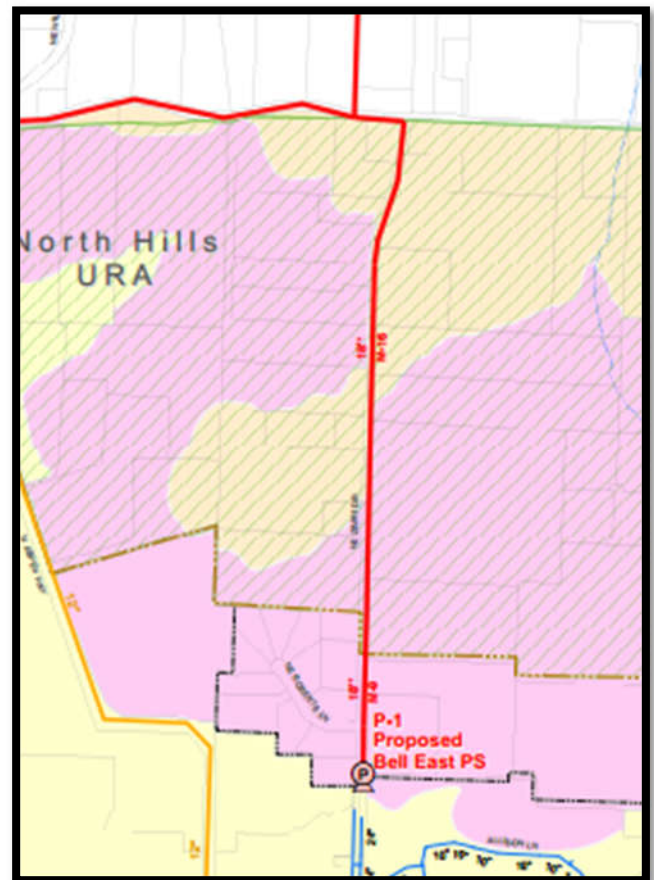


FIGURE 29 WATERLINE

CAPITAL IMPROVEMENT PROGRAM

WATER PROJECT Fire Flow - Various

There are several more fire flow upgrades projects noted in the 2017 Water Master Plan. The priorities will be decided based on other projects and opportunities.

PROPOSED FUNDING

These projects will be funded by the SDC and water rate funds.

HIGH PRIORITY PROJECT

The Council has identified increased sustainability as a priority for Newberg. Along with responding to Council goals the project will increase health and safety.

HISTORY OF THE PROJECT

The 2017 Water Master Plan identified several locations that need to be upgraded to provide increased fire flows.

MANDATED FEATURES

NA

CONTACT

engineering@newbergoregon.gov



FIGURE 30 FIRE FLOW UPGRADES

CAPITAL IMPROVEMENT PROGRAM

WATER PROJECT

North Valley Reservoir Driveway

The access to the North Valley Reservoirs is currently gravel and has drainage issues. This project would correct the drainage issues and pave the access to allow the City to access this important asset in all-weather situations.

PROPOSED FUNDING

This project will be funded by water rate revenues.

HIGH PRIORITY PROJECT

The Council has identified increased sustainability as a priority for Newberg. Along with responding to Council goals the project will:

- Increase health and safety
- Reduce costs

HISTORY OF THE PROJECT

The existing access is gravel with an undersized culvert. The City is responsible for maintenance of this access.

MANDATED FEATURES

NA

CONTACT

engineering@newbergoregon.gov



FIGURE 31 NORTH VALLEY RESERVOIR ACCESS ROAD

CAPITAL IMPROVEMENT PROGRAM

WATER PROJECT

Routine Water Main Replacement

As existing pipes age and reach the end of life, they need to be replaced. It is better to replace pipes on a routine basis than as an emergency repair. This project also includes the replacement of water pipes to be more resilient in a natural disaster.

PROPOSED FUNDING

This project will be funded by water rate revenues.

HIGH PRIORITY PROJECT

The Council has identified increased sustainability as a priority for Newberg. Replacing pipes on a routine basis is better for the residents and the environment. Along with responding to Council goals the project will:

- Increase health and safety
- Reduce costs
- Coordinates with larger planned projects

HISTORY OF THE PROJECT

The 2017 Water Master Plan identified water lines that were near the end of life and need to be replaced. Additionally, the seismic plan indicated that the critical water pipes be replaced to become more resilient. Staff is coordinating these projects with other utility and transportation projects.

STATE MANDATED FEATURES

The seismic resilience study was guided by the Oregon Resilience Plan and meets relevant requirements of OAR Chapter 333, Division 061-0060(5)(a)(J). This information is being incorporated into the technical update of the Water Master Plan.

CONTACT

engineering@newbergoregon.gov

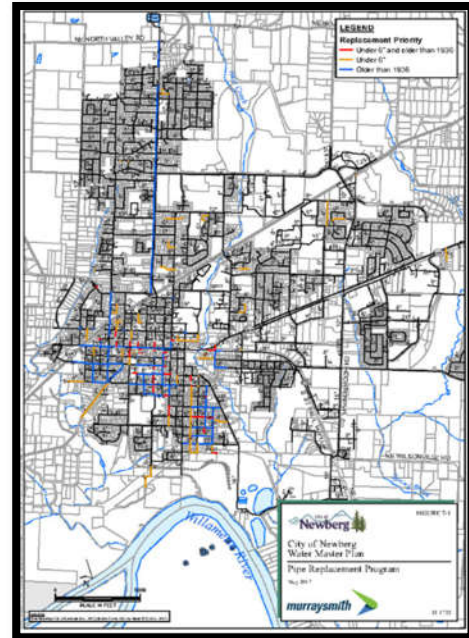


FIGURE 32 CITY WATER SERVICE



CAPITAL IMPROVEMENT PROGRAM

WATER PROJECT Water Treatment Plant Filter Covers

There is a need to cover the treatment plant filters to meet State requirements for airborne contamination of treated water. This project will design and construct the required covers.

PROPOSED FUNDING

This project will be funded by the water rate revenues.

HIGH PRIORITY PROJECT

This is a regulatory requirement.

HISTORY OF THE PROJECT

This was required after an annual inspection of the water treatment plant.

MANDATED FEATURES

Covers are required by the Oregon Drinking Water Authority.

CONTACT

kaaren.hofmann@newbergoregon.gov



FIGURE 33 WATER FILTER COVERS

CAPITAL IMPROVEMENT PROGRAM

WATER PROJECT

NE Zimri Drive Water Line

This project will extend a public water line in NE Zimri Drive to provide a water distribution line to serve the upper pressure zones in the City.

PROPOSED FUNDING

Water rate revenues and system development charges.

LOW PRIORITY PROJECT

This project is to provide for future growth.

HISTORY OF THE PROJECT

This project is in the 2017 Water Master Plan and is needed as development occurs north of and along NE Zimri Drive.

MANDATED FEATURES

NA

CONTACT

engineering@newbergoregon.gov

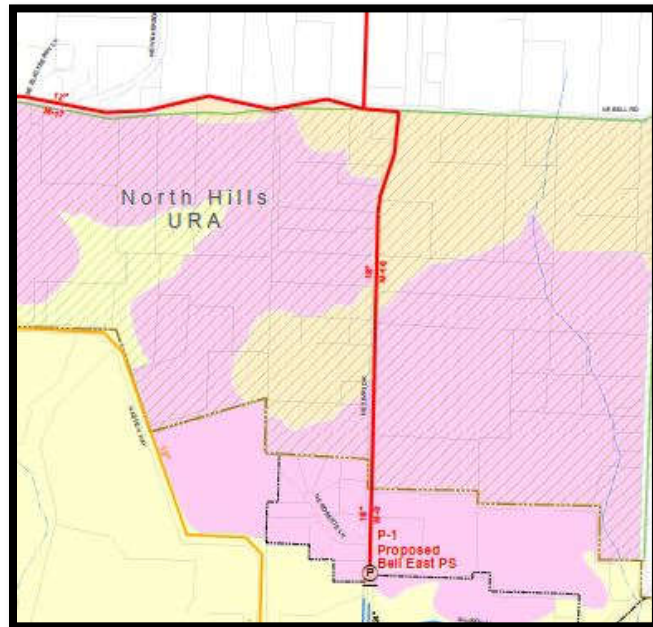


FIGURE 34 NE ZIMRI DRIVE

CAPITAL IMPROVEMENT PROGRAM

WATER PROJECT

American Water Infrastructure Act

The America's Water Infrastructure Act of 2018 requires community water systems that serve more than 3,300 people to complete a risk and resilience assessment and develop an emergency response plan. The certification of completion for the assessment must be submitted by 6/30/2021. The response plan must be completed no later than six months after the assessment. This is required to be reviewed every five years.

PROPOSED FUNDING

Water rate revenues.

HIGH PRIORITY PROJECT

The Council has identified increased sustainability as a priority for Newberg. Along with responding to Council goals the project will increase health and safety and complies with a federal and state mandate.

HISTORY OF THE PROJECT

This is a requirement from the Environmental Protection Agency. This assessment and plan is a replacement of the existing Water Vulnerability Study that was completed in the early 2000s.

MANDATED FEATURES

NA

CONTACT

engineering@newbergoregon.gov

RISK AND RESILIENCE ASSESSMENTS AND EMERGENCY RESPONSE PLANS:

Section 2013 of America's Water Infrastructure Act of 2018 (AWIA) requires community water systems¹ that serve more than 3,300 people to complete a risk and resilience assessment and develop an emergency response plan.

	RISK AND RESILIENCE ASSESSMENT	EMERGENCY RESPONSE PLAN
Important Dates	<ul style="list-style-type: none">March 31, 2020 if serving ≥100,000 people.December 31, 2020 if serving 50,000 to 99,999 people.June 30, 2021 if serving 3,301 to 49,999 people.	<ul style="list-style-type: none">September 30, 2020 if serving ≥100,000 people.June 30, 2021 if serving 50,000 to 99,999 people.December 30, 2021 if serving 3,301 to 49,999 people.
Recertification	<p>Every five years, your utility must review the risk and resilience assessment and submit a recertification to the U.S. EPA that the assessment has been reviewed and, if necessary, revised.</p> <p>Visit the U.S. EPA website to find more information on guidance for developing a risk and resilience assessment at https://www.epa.gov/waterriskassessment/developing-risk-and-resilience-assessment.</p>	<p>Within six months of submitting the recertification for the risk and resilience assessment, your utility must certify it has reviewed and, if necessary, revised, its emergency response plan.</p> <p>Visit the U.S. EPA website for guidance on developing an Emergency Response Plan at https://www.epa.gov/waterutilityresponse/developing-emergency-response-plan.</p>

TOOLS OR METHODS

AWIA does not require the use of any standards, methods or tools for the risk and resilience assessment or emergency response plan. Your utility is responsible for ensuring that the risk and resilience assessment and emergency response plan address all the criteria in AWIA Section 2013(a) and (b), respectively. The U.S. EPA recommends the use of standards, including AWWA 100-10 Risk and Resilience Management of Water and Wastewater Systems, along with tools from the U.S. EPA and other organizations, to facilitate sound risk and resilience assessments and emergency response plans.

¹ Section 2013 of AWIA applies to community water systems. Community water systems are drinking water utilities that consistently serve at least 25 people or 15 service connections year-round.

Still have questions about the new AWIA requirements?
Contact the U.S. Environmental Protection Agency (U.S. EPA) at dwrresilience@epa.gov.

Office of Water (4603T)
EPA-817-R-19-024
May 2019

CAPITAL IMPROVEMENT PROGRAM

WATER PROJECT

Water Treatment Plant Seismic Improvements

The existing WTP is susceptible to liquefaction, ground deformation, and lateral spreading. This project will implement needed improvements to the water system to meet the Oregon Resilience Plan and City of Newberg Level of Service Goals. The goal of rehabilitation is to address the deficiencies identified in previous studies by installing ground improvements between the WTP site and the shoreline to prevent lateral movement and strengthening structural components to withstand a Cascadia Subduction Zone event.

PROPOSED FUNDING

Water rate revenues.

HIGH PRIORITY PROJECT

The Council has identified increased sustainability as a priority for Newberg. Along with responding to Council goals the project will increase health and safety and complies with a federal and state mandate.

HISTORY OF THE PROJECT

In support of the 2017 Water Master Plan and Oregon Health Authority (OHA) guidelines, the City conducted a water system seismic resilience assessment (SRA). In general, the review of the structures indicated that none meet either the structural or non-structural performance objectives outlined as part of the Seismic Recovery Goals. Significant work is required at the WTP to meet recovery goals.

MANDATED FEATURES

Compliance with the Oregon Resilience Plan.

CONTACT

engineering@newbergoregon.gov

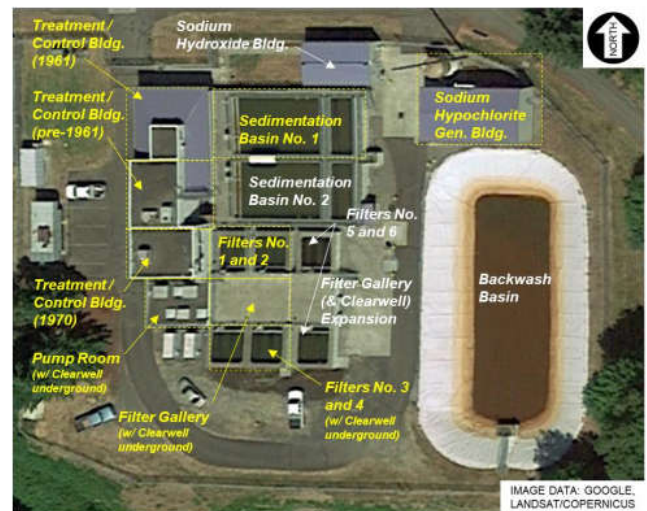


Figure 3.13 – Newberg Water Treatment Plant Location Map

CAPITAL IMPROVEMENT PROGRAM

WATER PROJECT

Emergency Connection & Controls

This project will implement needed improvements to the water system to meet the Oregon Resilience Plan and City of Newberg Level of Service Goals. As identified in the vulnerability assessment, the Waste Treatment Plant poses several risks if a Cascadia Subduction Zone earthquake occurs. By adding a point for emergency cross-connection and installing hydraulic control valves, the plant could be isolated during an earthquake event, allowing raw water to continue into the distribution system.

PROPOSED FUNDING

Water rate revenues.

HIGH PRIORITY PROJECT

The Council has identified increased sustainability as a priority for Newberg. Along with responding to Council goals the project will increase health and safety and complies with a federal and state mandate.

HISTORY OF THE PROJECT

In support of the 2017 Water Master Plan and Oregon Health Authority (OHA) guidelines, the City conducted a water system Seismic Resilience Assessment (SRA).

MANDATED FEATURES

Compliance with the Oregon Resilience Plan.

CONTACT

engineering@newbergoregon.gov

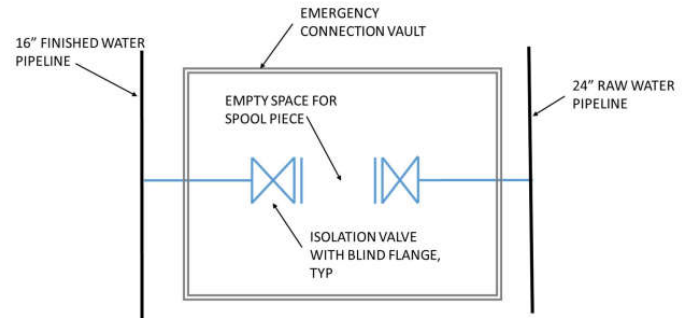


Figure 1. Raw Water Emergency Connection Vault

CAPITAL IMPROVEMENT PROGRAM

WATER PROJECT

Reservoirs Seismic Improvements

This project will implement needed improvements to the water system to meet the Oregon Resilience Plan and City of Newberg Level of Service Goals for the water reservoirs. By adding hydraulic control valves and replacing a portion of the pipe at North Valley Reservoirs, water storage at the tanks could be preserved.

PROPOSED FUNDING

Water rate revenues.

HIGH PRIORITY PROJECT

The Council has identified increased sustainability as a priority for Newberg. Along with responding to Council goals the project will increase health and safety and complies with a federal and state mandate.

HISTORY OF THE PROJECT

In support of the 2017 Water Master Plan and Oregon Health Authority (OHA) guidelines, the City conducted a water system Seismic Resilience Assessment (SRA).

MANDATED FEATURES

Compliance with the Oregon Resilience Plan.

CONTACT

engineering@newbergoregon.gov



Figure 3.6 – Former Chlorination Building

CAPITAL IMPROVEMENT PROGRAM

WATER PROJECT HB2001 Improvements

This project will implement needed improvements to the water system to comply with HB 2001; Middle Housing requirements. This project will upsize several pipes in the area south of downtown Newberg.

PROPOSED FUNDING

Water rate revenues.

HIGH PRIORITY PROJECT

The Council has identified increased sustainability and improved diversity, equity, inclusion, and housing as priorities for Newberg.

HISTORY OF THE PROJECT

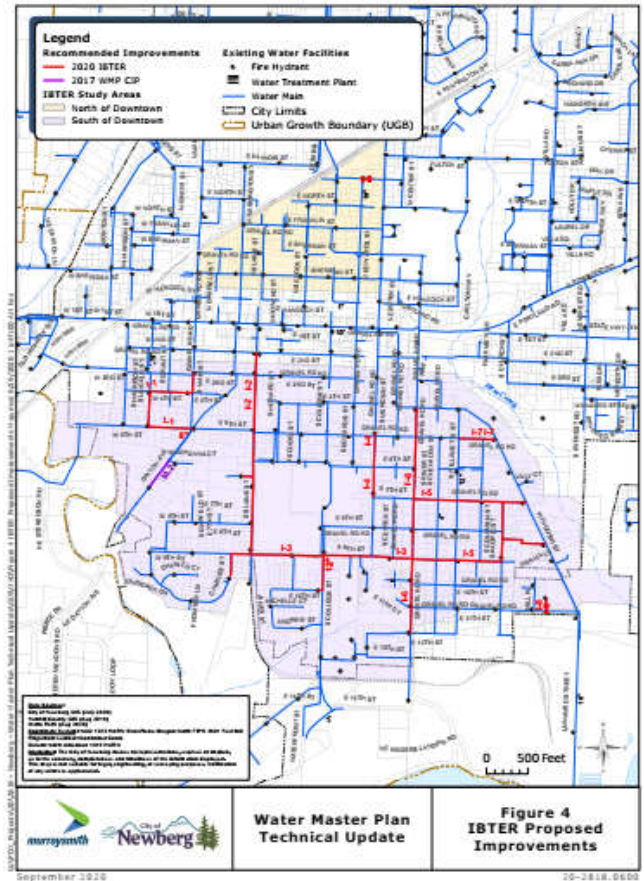
In the evaluation of providing for middle housing it was determined that several of the water pipes in the area south of downtown are not adequate to provide the required fire flow.

MANDATED FEATURES

NA

CONTACT

engineering@newbergoregon.gov



Recommended Improvements

Project No.	Project Description	Estimated Project Cost ¹⁴
I-1	Install 1,733 LF of 8-inch DI Pipe in S Main Street, W 4th Street, S Lincoln Street, and W 5th Street	\$486,000
I-2	Install 2,558 LF of 12-inch DI Pipe in S Blaine Street	\$812,000
I-3	Install 2,962 LF of 8- and 12-inch DI Pipe in E 9th Street, Charles Street, and S College Street	\$1,756,000
I-4	Install 772 LF of 8- and 12-inch DI Pipe in S Meridian Street	\$440,000
I-5	Install 3,691 LF of 12-inch DI Pipe in E 7th Street, S Pacific Street, E 9th Street, and Paradise Drive	\$1,167,000
I-6	Install 2,736 LF of 12-inch DI Pipe in S River Street	\$868,000
I-7	Install 453 LF of 12-inch DI Pipe in E 5th Street	\$148,000
I-8	Install 259 LF of 8-inch DI Pipe from E 11th Street to the Boston Square Apartments	\$49,000
I-9	Install 15 LF of 8-inch DI Pipe in Vermillion Street	\$11,000
Total Cost		\$8,797,000

CAPITAL IMPROVEMENT PROGRAM

WATER PROJECT Otis Springs Improvements

This project will construct the necessary improvements to Otis Springs to allow for this resource to be used in the Non-Potable Water System. New pumps must be installed in order to meet the desired flow rates and standard pressures of 30-90 psi. Larger tank size is required in order to successfully fill and drain under the 9 hour irrigation period each day.



PROPOSED FUNDING

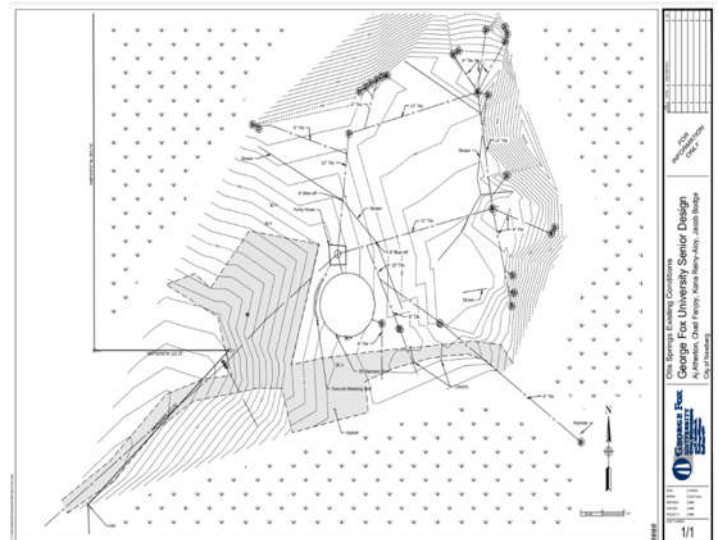
Water rate revenues.

PRIORITY PROJECT

The Council has identified increased sustainability as a priority for Newberg.

HISTORY OF THE PROJECT

This project is in the 2017 Water Master Plan as an integral part of the Non-Potable Water System. The existing Otis Springs infrastructure and non-potable supply is not adequate for the City's proposed developments shown in Option B of the 'Water Master Plan May 2017'.



MANDATED FEATURES

NA

CONTACT

brett.musick@newbergoregon.gov

**Exhibit “C” to Ordinance No. 2021-2876
Comprehensive Plan Amendment – File CPTA20-0003**

Note: Existing text is shown in regular font.
Added text is shown in double underline
Deleted text is shown in ~~striketrough~~.

The Newberg Comprehensive Plan shall be amended as follows:

**VIII. 2017 WATER MASTER PLAN AND ADDDENDUM - RIVERFRONT MASTER PLAN
2021**

Under separate cover.



RESOLUTION No. 2020-3686

**A RESOLUTION INITIATING AN AMENDMENT TO THE NEWBERG
COMPREHENSIVE PLAN TO UPDATE THE TRANSPORTATION SYSTEM
PLAN, WATER MASTER PLAN, WASTEWATER MASTER PLAN AND
STORMWATER MASTER PLAN**

RECITALS:

1. On September 16, 2019 the City Council adopted Resolution No. 2019-3596 accepting the Riverfront Master Plan.
2. The Riverfront Master Plan is a long range plan that provides guidance on future actions, which are needed to carry out the plan vision. An implementation strategy was created that outlines short and long term actions for the Plan (Appendix E). The actions include additional planning, regulatory updates, infrastructure projects, and program/funding development.
3. The request is to consider initiating an amendment to the Newberg Comprehensive Plan to update the Transportation System Plan, Water Master Plan, Wastewater Master Plan and Stormwater Master Plan.

THE CITY OF NEWBERG RESOLVES AS FOLLOWS:

1. The City Council initiates an amendment to the Newberg Comprehensive Plan - Transportation System Plan, Water Master Plan, Wastewater Master Plan and Stormwater Master Plan to implement the Riverfront Master Plan. The Wastewater Master Plan will additionally be evaluating the feasibility to redistribute flows to the Fernwood basin and to define the term "surcharge". The Stormwater Master Plan will be a citywide update for the plan. This starts the public process to study the proposed amendments.
2. By initiating this amendments, the City Council does not commit to taking any specific action on the proposal. It only wishes to give the amendments full consideration by the Planning Commission and City Council in public hearings.

///

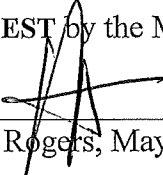
➤ **EFFECTIVE DATE** of this resolution is the day after the adoption date, which is: July 7, 2020.

ADOPTED by the City Council of the City of Newberg, Oregon, this 6th day of July, 2020.



Sue Ryan, City Recorder

ATTEST by the Mayor this 9th day of July, 2020.



Rick Rogers, Mayor



PLANNING COMMISSION RESOLUTION 2021-365

**A RESOLUTION RECOMMENDING CITY COUNCIL INCORPORATE THE 2017
WATER MASTER PLAN – ADDENDUM RIVERFRONT MASTER PLAN 2021 INTO
THE NEWBERG COMPREHENSIVE PLAN**


RECITALS

1. The City of Newberg last updated its Water Master Plan in 2017.
2. The Newberg City Council adopted Resolution 2020-3686 on July 6, 2020, which initiated amendments to the Newberg Comprehensive Plan – Transportation System Plan.
3. The 2017 Water Master Plan – Addendum Riverfront Master Plan 2021 was prepared in accordance with Oregon Statewide Planning Goal 11 - Public Facilities and Services, ORS 197.712(2)(e), and Oregon Administrative Rules Chapter 660 Division 11 Public Facilities Planning.
4. Oregon Administrative Rules Chapter 660 Division 11 Public Facilities Planning requires that a Water Master Plan be a part of a Comprehensive Plan.
5. The 2017 Water Master Plan – Addendum Riverfront Master Plan 2021 Ad Hoc Citizens Advisory Committee met two times during the plan development providing feedback to the consultant and city staff.
6. After proper notice, the Newberg Planning Commission opened the hearing on April 8, 2021, considered public testimony and deliberated. They found that the proposed amendment was in the best interests of the City.

The Newberg Planning Commission resolves as follows:

1. The Planning Commission of the City of Newberg recommends the City Council incorporate the 2017 Water Master Plan – Addendum Riverfront Master Plan 2021 into the Newberg Comprehensive Plan.
2. This recommendation is based on the staff report, Exhibit “A” 2017 Water Master Plan – Addendum Riverfront Master Plan 2021, the Findings in Exhibit “B”, and Comprehensive Plan text language in Exhibit ”C”.

Adopted by the Newberg Planning Commission this 8th day of April, 2021.



Planning Commission Chair

ATTEST:


Planning Commission Secretary

List of Exhibits:

- Exhibit "A": 2017 Water Master Plan – Addendum Riverfront Master Plan 2021
- Exhibit "B": Findings including Attachment 1 Newberg Urban Area Growth Management Agreement 1979 (as amended) and Attachment 2 Five Year Multi-Funded & Water Capital Improvement Plan
- Exhibit "C": Comprehensive Plan Text Amendment

As a conservation measure Exhibits “A”, “B”, and “C” are not included to the Planning Commission Resolution and can be accessed in the case file CPTA21-0003.